

1.5MHz, 300mA Synchronous Step-Down Regulator in ThinSOT

FEATURES

- **High Efficiency: Up to 96%**
- **Very Low Quiescent Current: Only 20 μ A During Operation**
- **300mA Output Current at $V_{IN} = 3V$**
- **2.5V to 5.5V Input Voltage Range**
- **1.5MHz Constant Frequency Operation**
- **No Schottky Diode Required**
- **Low Dropout Operation: 100% Duty Cycle**
- 0.8V Reference Allows Low Output Voltages
- Shutdown Mode Draws < 1 μ A Supply Current
- $\pm 2\%$ Output Voltage Accuracy
- Current Mode Operation for Excellent Line and Load Transient Response
- Overtemperature Protected
- Low Profile (1mm) ThinSOT™ Package

APPLICATIONS

- Cellular Telephones
- Personal Information Appliances
- Wireless and DSL Modems
- Digital Still Cameras
- MP3 Players
- Portable Instruments

DESCRIPTION

The LTC[®]3405 is a high efficiency monolithic synchronous buck regulator using a constant frequency, current mode architecture. Supply current during operation is only 20 μ A and drops to < 1 μ A in shutdown. The 2.5V to 5.5V input voltage range makes the LTC3405 ideally suited for single Li-Ion battery-powered applications. 100% duty cycle provides low dropout operation, extending battery life in portable systems.

Switching frequency is internally set at 1.5MHz, allowing the use of small surface mount inductors and capacitors.

The internal synchronous switch increases efficiency and eliminates the need for an external Schottky diode. Low output voltages are easily supported with the 0.8V feedback reference voltage. The LTC3405 is available in a low profile (1mm) ThinSOT package.

For new designs, refer to the LTC3405A data sheet. For fixed 1.5V and 1.8V output versions, refer to the LTC3405A-1.5/LTC3405A-1.8 data sheet.

LT, LTC and LT are registered trademarks of Linear Technology Corporation. ThinSOT is a trademark of Linear Technology Corporation. Protected by U.S. Patents, including 6580258, 5481178.

TYPICAL APPLICATION

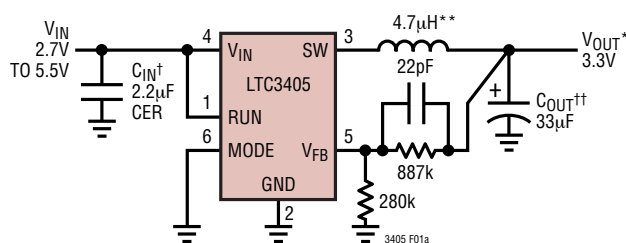

* V_{OUT} CONNECTED TO V_{IN} FOR $2.7V < V_{IN} < 3.3V$
 **MURATA LQH3C4R7M34
 †TAIYO YUDEN LMK212BJ225MG
 ††AVX TPSB336K006R0600

Figure 1a. High Efficiency Step-Down Converter

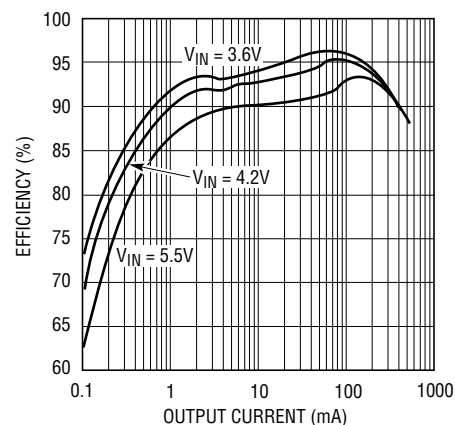

Figure 1b. Efficiency vs Load Current

3405 F01b

ABSOLUTE MAXIMUM RATINGS

(Note 1)

Input Supply Voltage	-0.3V to 6V
MODE, RUN, V _{FB} Voltages	-0.3V to V _{IN}
SW Voltage	-0.3V to (V _{IN} + 0.3V)
P-Channel Switch Source Current (DC)	400mA
N-Channel Switch Sink Current (DC)	400mA
Peak SW Sink and Source Current	630mA
Operating Temperature Range (Note 2) ..	-40°C to 85°C
Junction Temperature (Note 3)	125°C
Storage Temperature Range	-65°C to 150°C
Lead Temperature (Soldering, 10 sec)	300°C

PACKAGE/ORDER INFORMATION

	ORDER PART NUMBER
	LTC3405ES6
	S6 PART MARKING
	LTXQ

Consult LTC Marketing for parts specified with wider operating temperature ranges.

ELECTRICAL CHARACTERISTICS

The ● denotes specifications which apply over the full operating temperature range, otherwise specifications are T_A = 25°C. V_{IN} = 3.6V unless otherwise specified.

SYMBOL	PARAMETER	CONDITIONS	MIN	TYP	MAX	UNITS
I _{VFB}	Feedback Current				±30	nA
I _{PK}	Peak Inductor Current	V _{IN} = 3V, V _{FB} = 0.7V, Duty Cycle < 35%	375	500	625	mA
V _{FB}	Regulated Feedback Voltage	(Note 4)	● 0.784	0.8	0.816	V
ΔV _{OVL}	ΔOutput Overvoltage Lockout	ΔV _{OVL} = V _{OVL} - V _{FB}	● 20	50	80	mV
ΔV _{FB}	Reference Voltage Line Regulation	V _{IN} = 2.5V to 5.5V (Note 4)	●	0.04	0.4	%/V
V _{LOADREG}	Output Voltage Load Regulation			0.5		%
V _{IN}	Input Voltage Range		● 2.5		5.5	V
I _S	Input DC Bias Current	(Note 5)				
	Pulse Skipping Mode	V _{FB} = 0.7V, Mode = 3.6V, I _{LOAD} = 0A		300	400	μA
	Burst Mode® Operation	V _{FB} = 0.83V, Mode = 0V, I _{LOAD} = 0A		20	35	μA
	Shutdown	V _{RUN} = 0V, V _{IN} = 4.2V		0.1	1	μA
f _{OSC}	Oscillator Frequency	V _{FB} = 0.8V	● 1.2	1.5	1.8	MHz
		V _{FB} = 0V		210		kHz
R _{PFET}	R _{DS(ON)} of P-Channel FET	I _{SW} = 100mA		0.7	0.85	Ω
R _{NFET}	R _{DS(ON)} of N-Channel FET	I _{SW} = -100mA		0.6	0.90	Ω
I _{LSW}	SW Leakage	V _{RUN} = 0V, V _{SW} = 0V or 5V, V _{IN} = 5V		±0.01	±1	μA
V _{RUN}	RUN Threshold		● 0.3	1	1.5	V
I _{RUN}	RUN Leakage Current		●	±0.01	±1	μA
V _{MODE}	MODE Threshold		● 0.3	1.5	2	V
I _{MODE}	MODE Leakage Current		●	±0.01	±1	μA

Burst Mode is a registered trademark of Linear Technology Corporation.

Note 1: Absolute Maximum Ratings are those values beyond which the life of a device may be impaired.

Note 2: The LTC3405E is guaranteed to meet performance specifications from 0°C to 70°C. Specifications over the -40°C to 85°C operating temperature range are assured by design, characterization and correlation with statistical process controls.

Note 3: T_J is calculated from the ambient temperature T_A and power dissipation P_D according to the following formula:

$$\text{LTC3405: } T_J = T_A + (P_D)(250^\circ\text{C/W})$$

Note 4: The LTC3405 is tested in a proprietary test mode that connects V_{FB} to the output of the error amplifier.

Note 5: Dynamic supply current is higher due to the gate charge being delivered at the switching frequency.

TYPICAL PERFORMANCE CHARACTERISTICS

(From Figure 1a Except for the Resistive Divider Resistor Values)

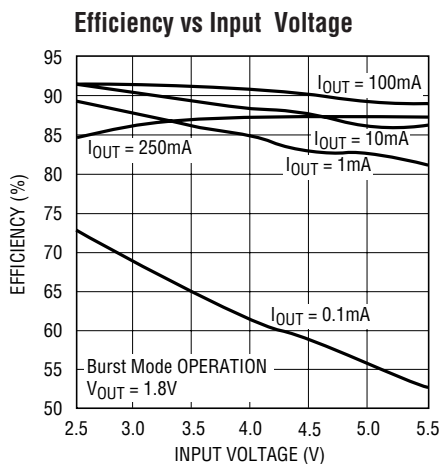

3405 G02

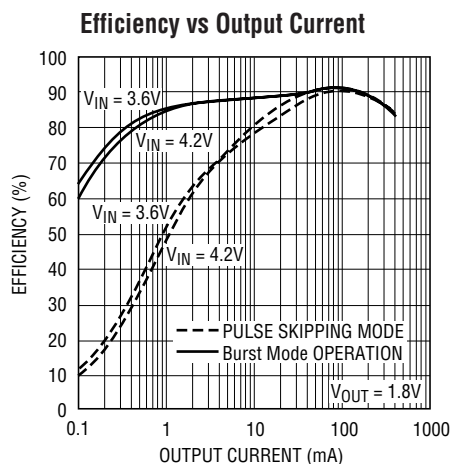

3405 G03

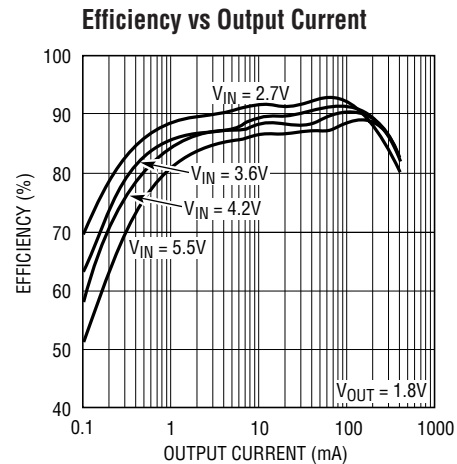

3405 G04

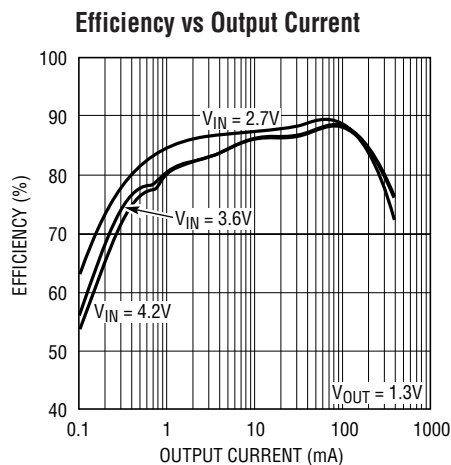

3405 G05

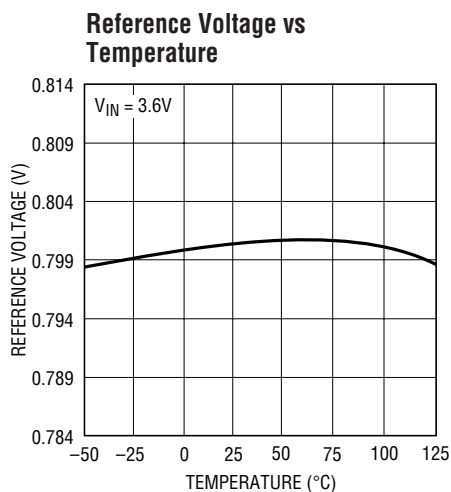

3405 G06

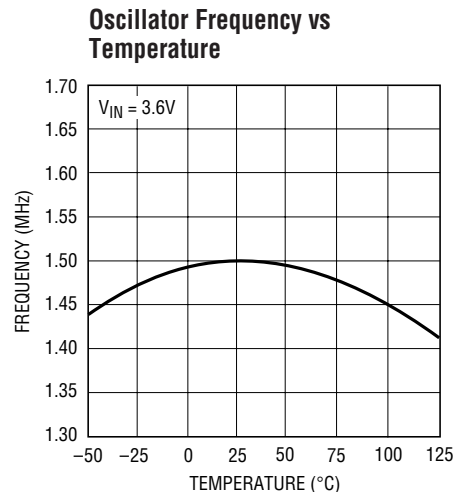

3405 G07

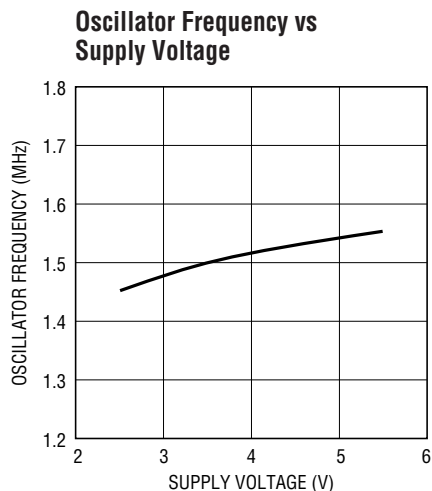

3405 G08

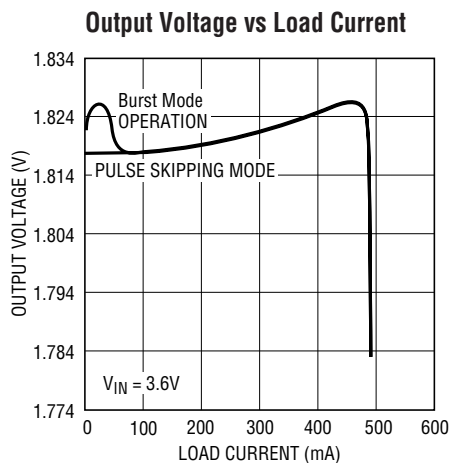

3405 G09

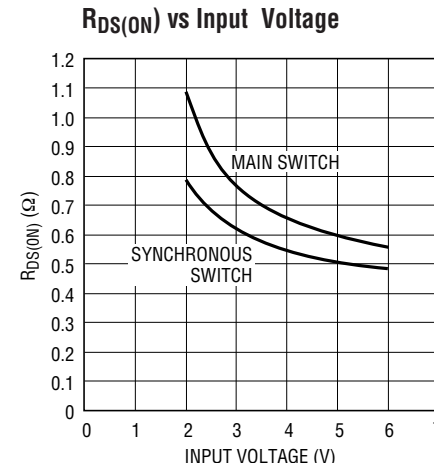

3405 G10

TYPICAL PERFORMANCE CHARACTERISTICS

(From Figure 1a Except for the Resistive Divider Resistor Values)

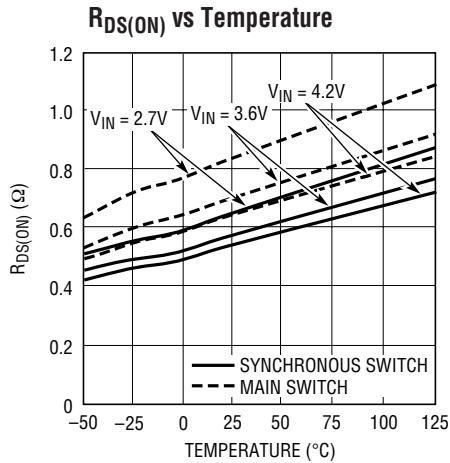

3405 G11

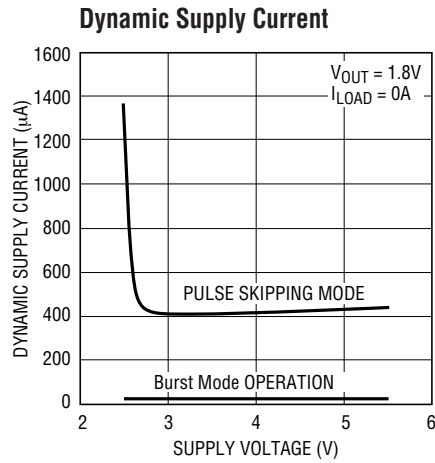

3405 G12

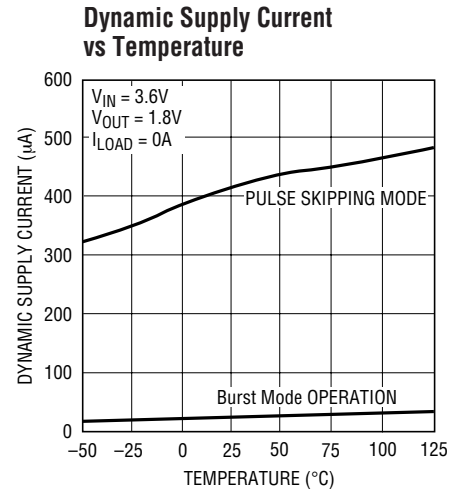

3405 G13

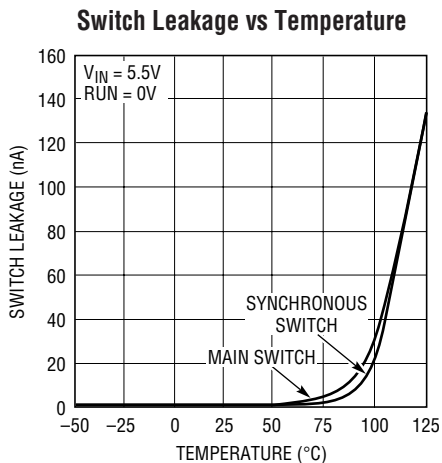

3405 G14

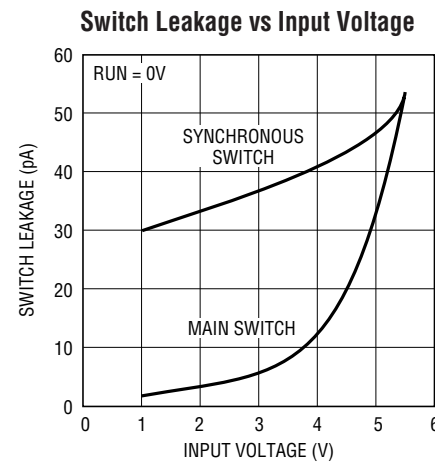

3405 G15

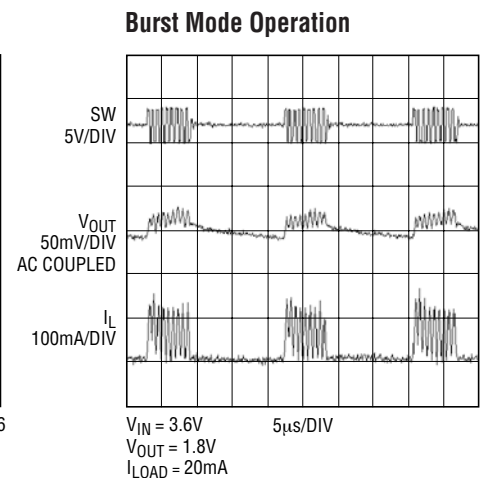

3405 G16

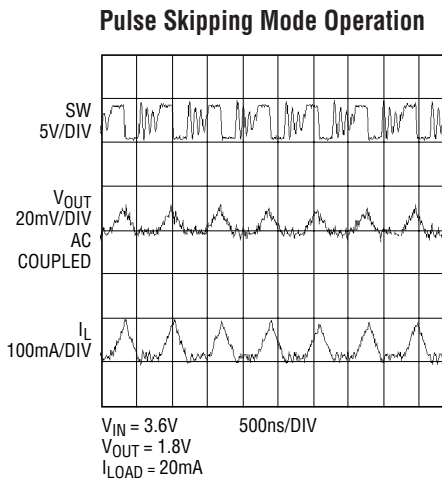

3405 G17

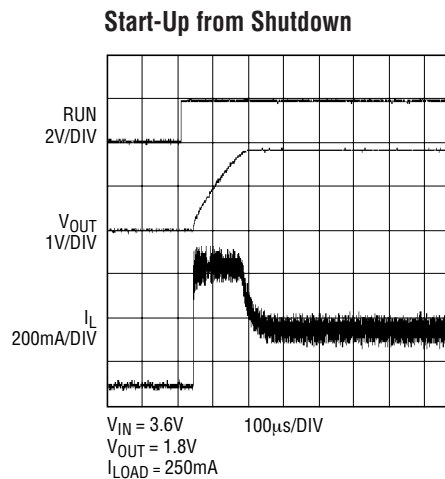

3405 G18

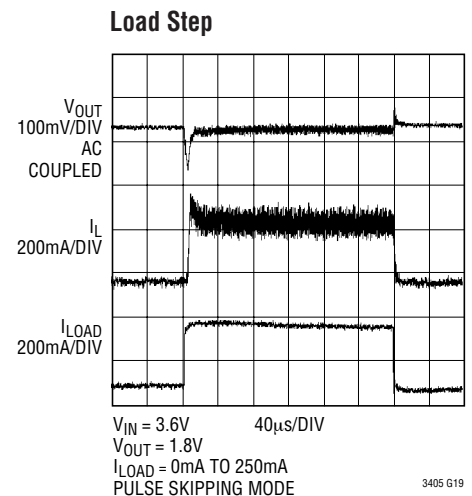

3405 G19

TYPICAL PERFORMANCE CHARACTERISTICS

(From Figure 1a Except for the Resistive Divider Resistor Values)

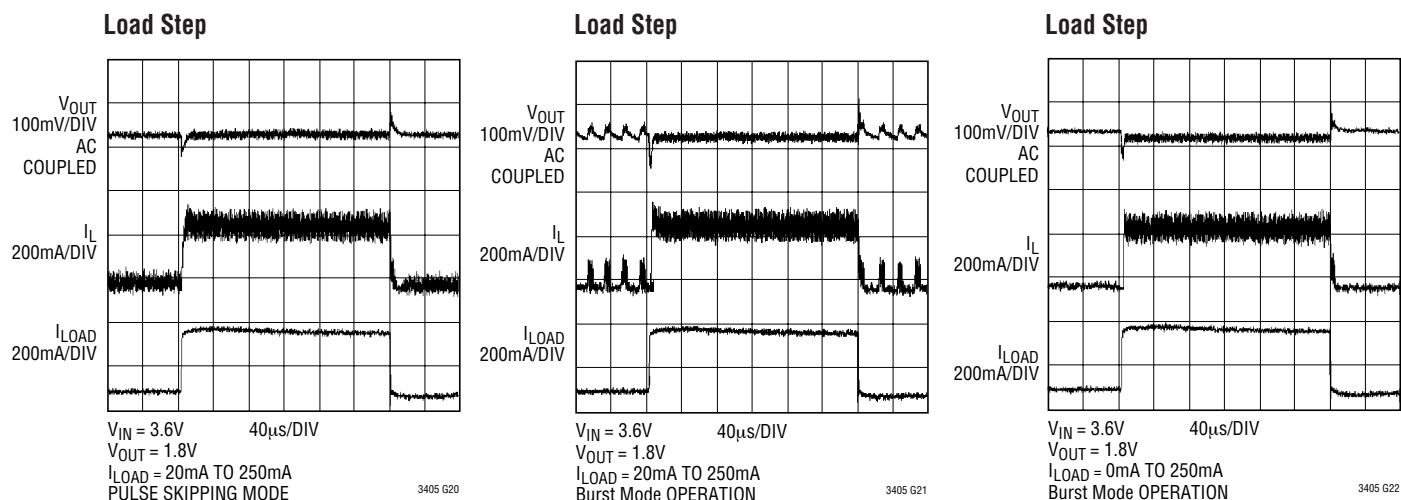

PIN FUNCTIONS

RUN (Pin 1): Run Control Input. Forcing this pin above 1.5V enables the part. Forcing this pin below 0.3V shuts down the device. In shutdown, all functions are disabled drawing $<1\mu A$ supply current. Do not leave RUN floating.

GND (Pin 2): Ground Pin.

SW (Pin 3): Switch Node Connection to Inductor. This pin connects to the drains of the internal main and synchronous power MOSFET switches.

V_{IN} (Pin 4): Main Supply Pin. Must be closely decoupled to GND, Pin 2, with a 2.2 μF or greater ceramic capacitor.

V_{FB} (Pin 5): Feedback Pin. Receives the feedback voltage from an external resistive divider across the output.

MODE (Pin 6): Mode Select Input. To select pulse skipping mode, tie to V_{IN} . Grounding this pin selects Burst Mode operation. Do not leave this pin floating.

FUNCTIONAL DIAGRAM

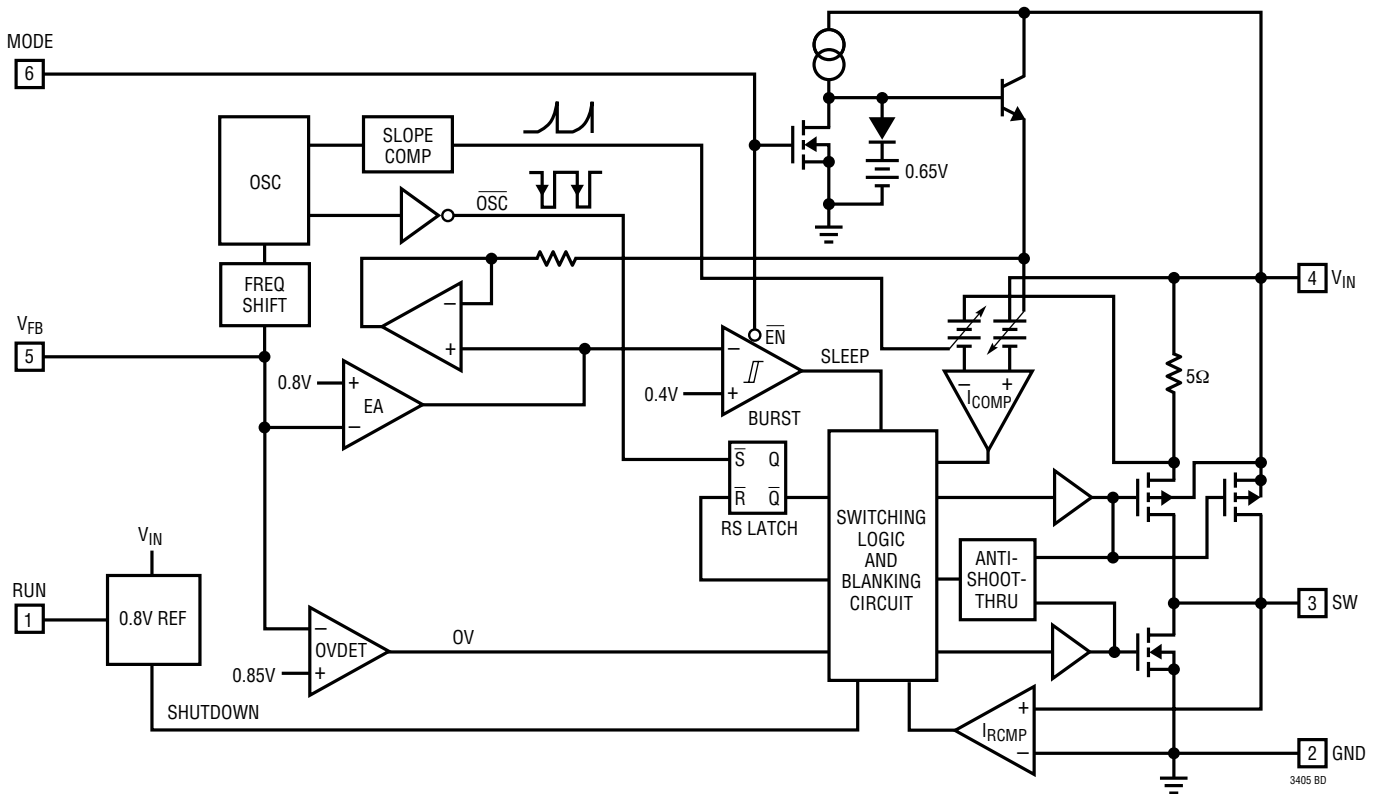

OPERATION (Refer to Functional Diagram)

Main Control Loop

The LTC3405 uses a constant frequency, current mode step-down architecture. Both the main (P-channel MOSFET) and synchronous (N-channel MOSFET) switches are internal. During normal operation, the internal top power MOSFET is turned on each cycle when the oscillator sets the RS latch, and turned off when the current comparator, I_{COMP} , resets the RS latch. The peak inductor current at which I_{COMP} resets the RS latch, is controlled by the output of error amplifier EA. The V_{FB} pin, described in the Pin Functions section, allows EA to receive an output

feedback voltage from an external resistive divider. When the load current increases, it causes a slight decrease in the feedback voltage relative to the 0.8V reference, which in turn, causes the EA amplifier's output voltage to increase until the average inductor current matches the new load current. While the top MOSFET is off, the bottom MOSFET is turned on until either the inductor current starts to reverse, as indicated by the current reversal comparator I_{RCMP} , or the beginning of the next clock cycle.

OPERATION (Refer to Functional Diagram)

Comparator OVDET guards against transient overshoots >6.25% by turning the main switch off and keeping it off until the fault is removed.

Burst Mode Operation

The LTC3405 is capable of Burst Mode operation in which the internal power MOSFETs operate intermittently based on load demand. To enable Burst Mode operation, simply connect the MODE pin to GND. To disable Burst Mode operation and enable PWM pulse skipping mode, connect the MODE pin to V_{IN} or drive it with a logic high ($V_{MODE} > 1.5V$). In this mode, the efficiency is lower at light loads, but becomes comparable to Burst Mode operation when the output load exceeds 25mA. The advantage of pulse skipping mode is lower output ripple and less interference to audio circuitry.

When the converter is in Burst Mode operation, the peak current of the inductor is set to approximately 100mA regardless of the output load. Each burst event can last from a few cycles at light loads to almost continuously cycling with short sleep intervals at moderate loads. In between these burst events, the power MOSFETs and any unneeded circuitry are turned off, reducing the quiescent current to 20 μ A. In this sleep state, the load current is being supplied solely from the output capacitor. As the output voltage droops, the EA amplifier's output rises above the sleep threshold signaling the BURST comparator to trip and turn the top MOSFET on. This process repeats at a rate that is dependent on the load demand.

Short-Circuit Protection

When the output is shorted to ground, the frequency of the oscillator is reduced to about 210kHz, 1/7 the nominal frequency. This frequency foldback ensures that the inductor current has more time to decay, thereby preventing runaway. The oscillator's frequency will progressively increase to 1.5MHz when V_{FB} rises above 0V.

Dropout Operation

As the input supply voltage decreases to a value approaching the output voltage, the duty cycle increases toward the maximum on-time. Further reduction of the supply voltage forces the main switch to remain on for more than one cycle

until it reaches 100% duty cycle. The output voltage will then be determined by the input voltage minus the voltage drop across the P-channel MOSFET and the inductor.

Another important detail to remember is that at low input supply voltages, the $R_{DS(ON)}$ of the P-channel switch increases (see Typical Performance Characteristics). Therefore, the user should calculate the power dissipation when the LTC3405 is used at 100% duty cycle with low input voltage (See Thermal Considerations in the Applications Information section).

Low Supply Operation

The LTC3405 will operate with input supply voltages as low as 2.5V, but the maximum allowable output current is reduced at this low voltage. Figure 2 shows the reduction in the maximum output current as a function of input voltage for various output voltages.

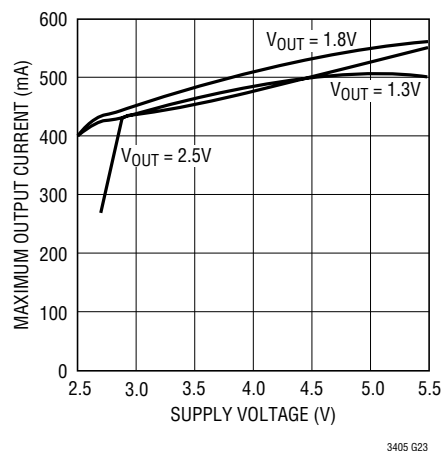

Figure 2. Maximum Output Current vs Input Voltage

Slope Compensation and Inductor Peak Current

Slope compensation provides stability in constant frequency architectures by preventing subharmonic oscillations at high duty cycles. It is accomplished internally by adding a compensating ramp to the inductor current signal at duty cycles in excess of 40%. Normally, this results in a reduction of maximum inductor peak current for duty cycles >40%. However, the LTC3405 uses a patent-pending scheme that counteracts this compensating ramp, which allows the maximum inductor peak current to remain unaffected throughout all duty cycles.

APPLICATIONS INFORMATION

The basic LTC3405 application circuit is shown in Figure 1. External component selection is driven by the load requirement and begins with the selection of L followed by C_{IN} and C_{OUT} .

Inductor Selection

For most applications, the value of the inductor will fall in the range of 3.3 μ H to 10 μ H. Its value is chosen based on the desired ripple current. Large value inductors lower ripple current and small value inductors result in higher ripple currents. Higher V_{IN} or V_{OUT} also increases the ripple current as shown in equation 1. A reasonable starting point for setting ripple current is $\Delta I_L = 120\text{mA}$ (40% of 300mA).

$$\Delta I_L = \frac{1}{(f)(L)} V_{OUT} \left(1 - \frac{V_{OUT}}{V_{IN}} \right) \quad (1)$$

The DC current rating of the inductor should be at least equal to the maximum load current plus half the ripple current to prevent core saturation. Thus, a 360mA rated inductor should be enough for most applications (300mA + 60mA). For better efficiency, choose a low DC-resistance inductor.

The inductor value also has an effect on Burst Mode operation. The transition to low current operation begins when the inductor current peaks fall to approximately 100mA. Lower inductor values (higher ΔI_L) will cause this to occur at lower load currents, which can cause a dip in efficiency in the upper range of low current operation. In Burst Mode operation, lower inductance values will cause the burst frequency to increase.

Inductor Core Selection

Different core materials and shapes will change the size/current and price/current relationship of an inductor. Toroid or shielded pot cores in ferrite or permalloy materials are small and don't radiate much energy, but generally cost more than powdered iron core inductors with similar electrical characteristics. The choice of which style inductor to use often depends more on the price vs size requirements and any radiated field/EMI requirements than on what the LTC3405 requires to operate. Table 1 shows some typical surface mount inductors that work well in LTC3405 applications.

Table 1. Representative Surface Mount Inductors

MANUFACTURER	PART NUMBER	VALUE	MAX DC CURRENT	DCR	HEIGHT
Taiyo Yuden	LB2016T3R3M	3.3 μ H	280mA	0.2 Ω	1.6mm
Panasonic	ELT5KT4R7M	4.7 μ H	950mA	0.2 Ω	1.2mm
Murata	LQH3C4R7M34	4.7 μ H	450mA	0.2 Ω	2mm
Taiyo Yuden	LB2016T4R7M	4.7 μ H	210mA	0.25 Ω	1.6mm
Panasonic	ELT5KT6R8M	6.8 μ H	760mA	0.3 Ω	1.2mm
Panasonic	ELT5KT100M	10 μ H	680mA	0.36 Ω	1.2mm
Sumida	CMD4D116R8MC	6.8 μ H	620mA	0.23 Ω	1.2mm

C_{IN} and C_{OUT} Selection

In continuous mode, the source current of the top MOSFET is a square wave of duty cycle V_{OUT}/V_{IN} . To prevent large voltage transients, a low ESR input capacitor sized for the maximum RMS current must be used. The maximum RMS capacitor current is given by:

$$C_{IN} \text{ required } I_{RMS} \approx I_{OMAX} \frac{[V_{OUT}(V_{IN} - V_{OUT})]^{1/2}}{V_{IN}}$$

This formula has a maximum at $V_{IN} = 2V_{OUT}$, where $I_{RMS} = I_{OUT}/2$. This simple worst-case condition is commonly used for design because even significant deviations do not offer much relief. Note that the capacitor manufacturer's ripple current ratings are often based on 2000 hours of life. This makes it advisable to further derate the capacitor, or choose a capacitor rated at a higher temperature than required. Always consult the manufacturer if there is any question.

The selection of C_{OUT} is driven by the required effective series resistance (ESR). An ESR in the range of 100m Ω to 200m Ω is necessary to provide a stable loop. For the LTC3405, the general rule for proper operation is:

$$0.1\Omega \leq C_{OUT} \text{ required ESR} \leq 0.6\Omega$$

ESR is a direct function of the volume of the capacitor; that is, physically larger capacitors have lower ESR. Once the ESR requirement for C_{OUT} has been met, the RMS current rating generally far exceeds the $I_{RIPPLE(P-P)}$ requirement. The output ripple ΔV_{OUT} is determined by:

$$\Delta V_{OUT} \approx \Delta I_L \left(\text{ESR} + \frac{1}{8fC_{OUT}} \right)$$

APPLICATIONS INFORMATION

where f = operating frequency, C_{OUT} = output capacitance and ΔI_L = ripple current in the inductor. For a fixed output voltage, the output ripple is highest at maximum input voltage since ΔI_L increases with input voltage.

Aluminum electrolytic and dry tantalum capacitors are both available in surface mount configurations. In the case of tantalum, it is critical that the capacitors are surge tested for use in switching power supplies. An excellent choice is the AVX TPS series of surface mount tantalum. These are specially constructed and tested for low ESR so they give the lowest ESR for a given volume. Other capacitor types include Sanyo POSCAP, Kemet T510 and T495 series, and Sprague 593D and 595D series. Consult the manufacturer for other specific recommendations.

Using Ceramic Input and Output Capacitors

Higher values, lower cost ceramic capacitors are now becoming available in smaller case sizes. Their high ripple current, high voltage rating and low ESR make them ideal for switching regulator applications. However, care must be taken when these capacitors are used at the input and the output. When a ceramic capacitor is used at the input and the power is supplied by a wall adapter through long wires, a load step at the output can induce ringing at the input, V_{IN} . At best, this ringing can couple to the output and be mistaken as loop instability. At worst, a sudden inrush of current through the long wires can potentially cause a voltage spike at V_{IN} , large enough to damage the part.

When ceramic capacitors are used at the output, their low ESR cannot provide sufficient phase lag cancellation to stabilize the loop. One solution is to use a tantalum capacitor, with its higher ESR, to provide the bulk capacitance and parallel it with a small ceramic capacitor to reduce the ripple voltage as shown in Figure 3.

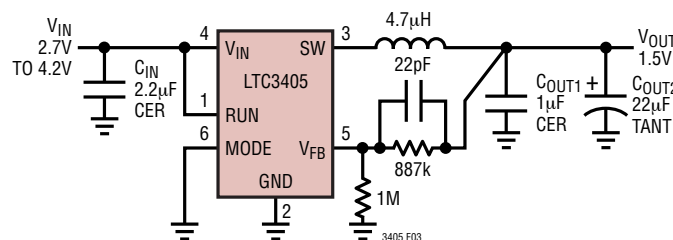

Figure 3. Paralleling a Ceramic with a Tantalum Capacitor

Another solution is to connect the feedback resistor to the SW pin as shown in Figure 4. Taking the feedback information at the SW pin removes the phase lag due to the output capacitor resulting in a very stable loop. This configuration lowers the load regulation by the DC resistance of the inductor multiplied by the load current. This slight shift in load regulation actually helps reduce the overshoot and undershoot of the output voltage during a load transient.

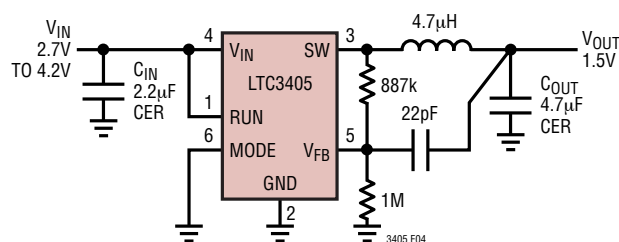

Figure 4. Using All Ceramic Capacitors

A third solution is to use a high value resistor to inject a feedforward signal at V_{FB} mimicking the ripple voltage of a high ESR output capacitor. The circuit in Figure 5 shows how this technique can be easily realized. The feedforward resistor, R_{2B} , is connected to SW as in the previous example. However, in this case, the feedback information is taken from the resistive divider, R_{2A} and R_1 , at the output. This eliminates most of the load regulation degradation due to the DC resistance of the inductor while providing a stable operation similar to that obtained from a high ESR tantalum type capacitor. Using this technique, the extra feedforward resistor, R_{2B} , must be accounted for when calculating the resistive divider as follows:

$$R_2 = R_{2A} \parallel R_{2B} = \frac{R_{2A} \cdot R_{2B}}{R_{2A} + R_{2B}}$$

$$V_{OUT} = 0.8V \left(1 + \frac{R_2}{R_1} \right)$$

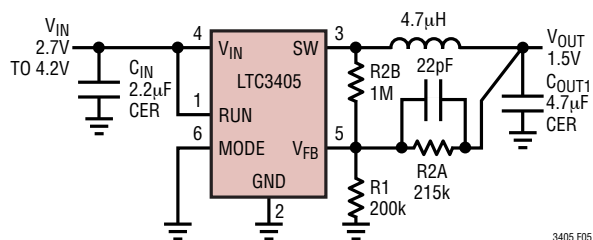

Figure 5. Feedforward Injection in an All Ceramic Capacitor Application

3405fa

APPLICATIONS INFORMATION

In pulse skipping mode, the LTC3405 is stable with a 4.7µF ceramic output capacitor with $V_{IN} \leq 4.2V$. For single Li-Ion applications operating in pulse skipping mode, the circuit shown in Figure 6 can be used

When choosing the input and output ceramic capacitors, choose the X5R or X7R dielectric formulations. These dielectrics have the best temperature and voltage characteristics of all the ceramics for a given value and size.

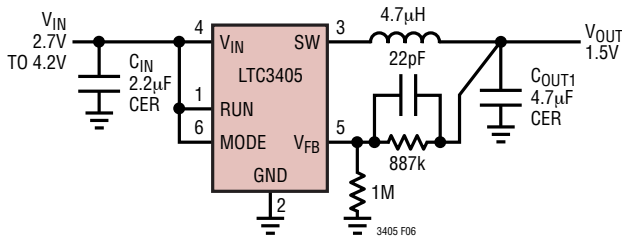

Figure 6. Using All Ceramic Capacitors in Pulse Skipping Mode

Output Voltage Programming

The output voltage is set by a resistive divider according to the following formula:

$$V_{OUT} = 0.8V \left(1 + \frac{R_2}{R_1} \right) \quad (2)$$

The external resistive divider is connected to the output, allowing remote voltage sensing as shown in Figure 7.

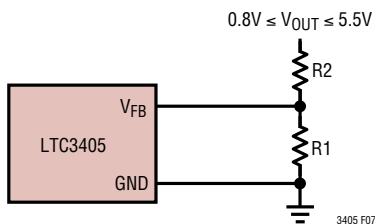

Figure 7. Setting the LTC3405 Output Voltage

Efficiency Considerations

The efficiency of a switching regulator is equal to the output power divided by the input power times 100%. It is often useful to analyze individual losses to determine what is limiting the efficiency and which change would produce the most improvement. Efficiency can be expressed as:

$$\text{Efficiency} = 100\% - (L_1 + L_2 + L_3 + \dots)$$

where L_1 , L_2 , etc. are the individual losses as a percentage of input power.

Although all dissipative elements in the circuit produce losses, two main sources usually account for most of the losses in LTC3405 circuits: V_{IN} quiescent current and I^2R losses. The V_{IN} quiescent current loss dominates the efficiency loss at very low load currents whereas the I^2R loss dominates the efficiency loss at medium to high load currents. In a typical efficiency plot, the efficiency curve at very low load currents can be misleading since the actual power lost is of no consequence as illustrated in Figure 8.

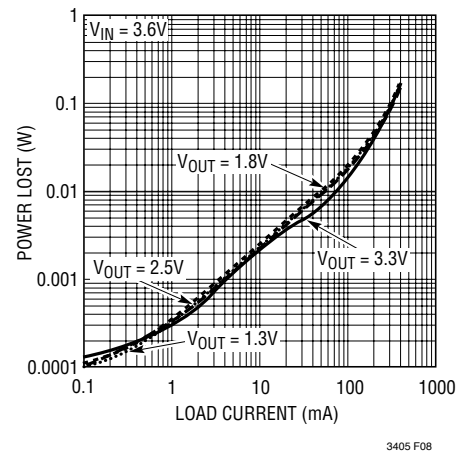

Figure 8. Power Lost vs Load Current

1. The V_{IN} quiescent current is due to two components: the DC bias current as given in the electrical characteristics and the internal main switch and synchronous switch gate charge currents. The gate charge current results from switching the gate capacitance of the internal power MOSFET switches. Each time the gate is switched from high to low to high again, a packet of charge, dQ , moves from V_{IN} to ground. The resulting dQ/dt is the current out of V_{IN} that is typically larger than the DC bias current. In continuous mode, $I_{GATECHG} = f(Q_T + Q_B)$ where Q_T and Q_B are the gate charges of the internal top and bottom switches. Both the DC bias and gate charge losses are proportional to V_{IN} and thus their effects will be more pronounced at higher supply voltages.
2. I^2R losses are calculated from the resistances of the internal switches, R_{SW} , and external inductor R_L . In continuous mode, the average output current flowing through inductor L is “chopped” between the main switch and the synchronous switch. Thus, the series resistance looking into the SW pin is a function of both

3405fa

APPLICATIONS INFORMATION

top and bottom MOSFET $R_{DS(ON)}$ and the duty cycle (DC) as follows:

$$R_{SW} = (R_{DS(ON)TOP})(DC) + (R_{DS(ON)BOT})(1 - DC)$$

The $R_{DS(ON)}$ for both the top and bottom MOSFETs can be obtained from the Typical Performance Characteristics curves. Thus, to obtain I^2R losses, simply add R_{SW} to R_L and multiply the result by the square of the average output current.

Other losses including C_{IN} and C_{OUT} ESR dissipative losses and inductor core losses generally account for less than 2% total additional loss.

Thermal Considerations

In most applications the LTC3405 does not dissipate much heat due to its high efficiency. But, in applications where the LTC3405 is running at high ambient temperature with low supply voltage and high duty cycles, such as in dropout, the heat dissipated may exceed the maximum junction temperature of the part. If the junction temperature reaches approximately 150°C, both power switches will be turned off and the SW node will become high impedance.

To avoid the LTC3405 from exceeding the maximum junction temperature, the user will need to do a thermal analysis. The goal of the thermal analysis is to determine whether the operating conditions exceed the maximum junction temperature of the part. The temperature rise is given by:

$$T_R = (P_D)(\theta_{JA})$$

where P_D is the power dissipated by the regulator and θ_{JA} is the thermal resistance from the junction of the die to the ambient temperature.

The junction temperature, T_J , is given by:

$$T_J = T_A + T_R$$

where T_A is the ambient temperature.

As an example, consider the LTC3405 in dropout at an input voltage of 2.7V, a load current of 300mA and an

ambient temperature of 70°C. From the typical performance graph of switch resistance, the $R_{DS(ON)}$ of the P-channel switch at 70°C is approximately 0.94Ω. Therefore, power dissipated by the part is:

$$P_D = I_{LOAD}^2 \cdot R_{DS(ON)} = 84.6mW$$

For the SOT-23 package, the θ_{JA} is 250°C/W. Thus, the junction temperature of the regulator is:

$$T_J = 70^\circ C + (0.0846)(250) = 91.15^\circ C$$

which is well below the maximum junction temperature of 125°C.

Note that at higher supply voltages, the junction temperature is lower due to reduced switch resistance ($R_{DS(ON)}$).

Checking Transient Response

The regulator loop response can be checked by looking at the load transient response. Switching regulators take several cycles to respond to a step in load current. When a load step occurs, V_{OUT} immediately shifts by an amount equal to $(\Delta I_{LOAD} \cdot ESR)$, where ESR is the effective series resistance of C_{OUT} . ΔI_{LOAD} also begins to charge or discharge C_{OUT} , which generates a feedback error signal. The regulator loop then acts to return V_{OUT} to its steady-state value. During this recovery time V_{OUT} can be monitored for overshoot or ringing that would indicate a stability problem. For a detailed explanation of switching control loop theory, see Application Note 76.

A second, more severe transient is caused by switching in loads with large ($>1\mu F$) supply bypass capacitors. The discharged bypass capacitors are effectively put in parallel with C_{OUT} , causing a rapid drop in V_{OUT} . No regulator can deliver enough current to prevent this problem if the load switch resistance is low and it is driven quickly. The only solution is to limit the rise time of the switch drive so that the load rise time is limited to approximately $(25 \cdot C_{LOAD})$. Thus, a 10μF capacitor charging to 3.3V would require a 250μs rise time, limiting the charging current to about 130mA.

APPLICATIONS INFORMATION

PC Board Layout Checklist

When laying out the printed circuit board, the following checklist should be used to ensure proper operation of the LTC3405. These items are also illustrated graphically in Figures 9 and 10. Check the following in your layout:

1. The power traces, consisting of the GND trace, the SW trace and the V_{IN} trace should be kept short, direct and wide.
2. Does the V_{FB} pin connect directly to the feedback resistors? The resistive divider R1/R2 must be connected between the (+) plate of C_{OUT} and ground.
3. Does the (+) plate of C_{IN} connect to V_{IN} as closely as possible? This capacitor provides the AC current to the internal power MOSFETs.

4. Keep the switching node, SW, away from the sensitive V_{FB} node.

Design Example

As a design example, assume the LTC3405 is used in a single lithium-ion battery-powered cellular phone application. The V_{IN} will be operating from a maximum of 4.2V down to about 2.7V. The load current requirement is a maximum of 0.25A but most of the time it will be in standby mode, requiring only 2mA. Efficiency at both low and high load currents is important. Output voltage is 2.5V. With this information we can calculate L using equation (1),

$$L = \frac{1}{(f)(\Delta I_L)} V_{OUT} \left(1 - \frac{V_{OUT}}{V_{IN}} \right) \quad (3)$$

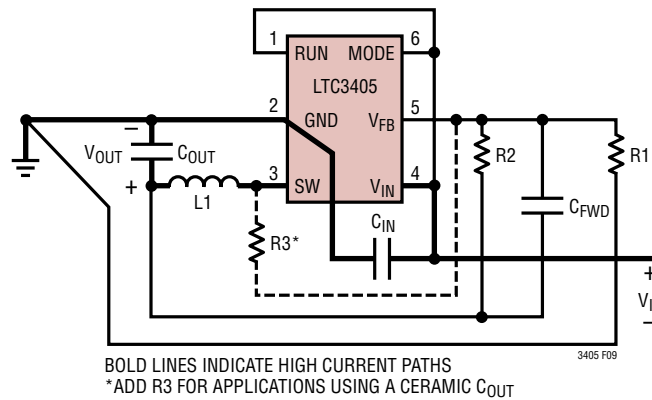

Figure 9. LTC3405 Layout Diagram

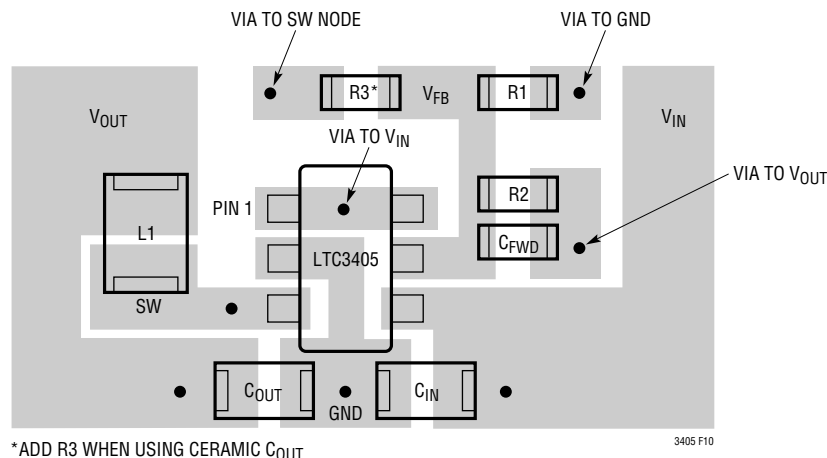

Figure 10. LTC3405 Suggested Layout

APPLICATIONS INFORMATION

Substituting $V_{OUT} = 2.5V$, $V_{IN} = 4.2V$, $\Delta I_L = 100mA$ and $f = 1.5MHz$ in equation (3) gives:

$$L = \frac{2.5V}{1.5MHz(100mA)} \left(1 - \frac{2.5V}{4.2V}\right) \cong 6.8\mu H$$

For best efficiency choose a 300mA or greater inductor with less than 0.3Ω series resistance.

C_{IN} will require an RMS current rating of at least $0.125A \cong I_{LOAD(MAX)}/2$ at temperature and C_{OUT} will require an ESR of less than 0.6Ω and greater than 0.1Ω . In most cases, a tantalum capacitor will satisfy this requirement.

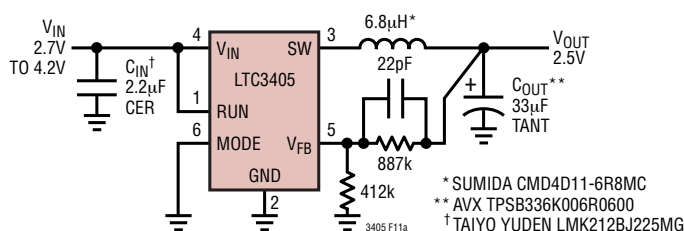

Figure 11a

For the feedback resistors, choose $R1 = 412k$. $R2$ can then be calculated from equation (2) to be:

$$R2 = \left(\frac{V_{OUT}}{0.8} - 1\right) R1 = 875.5k; \text{ use } 887k$$

Figure 11 shows the complete circuit along with its efficiency curve.

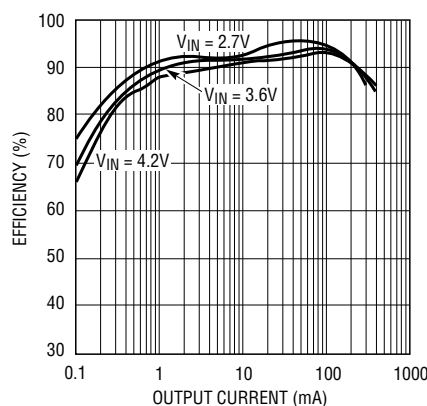
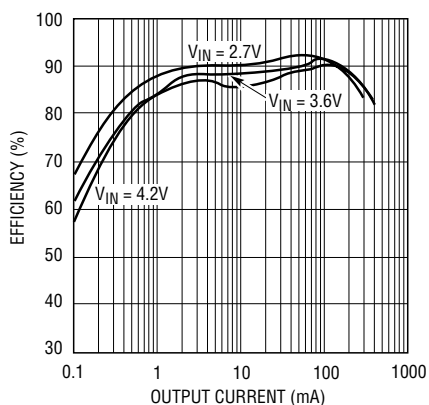
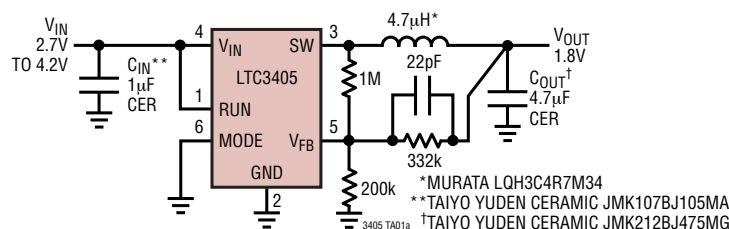

Figure 11b

TYPICAL APPLICATIONS

Single Li-Ion to 1.8V/300mA Regulator Optimized for Small Footprint and High Efficiency



3405 TA01b

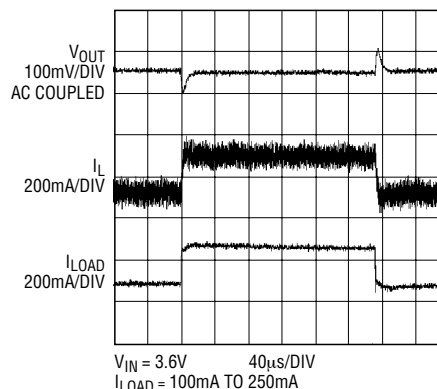

3405 TA01c

TYPICAL APPLICATIONS

Single Li-Ion to 1.8V/300mA Regulator
Using Ceramic and Tantalum Output Capacitors

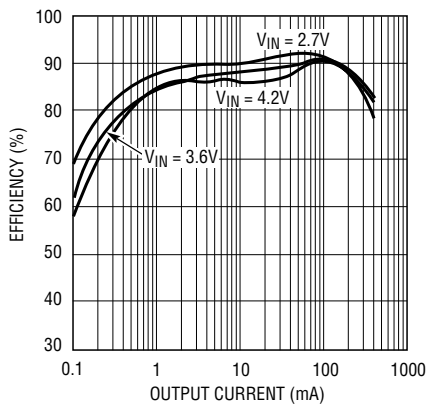
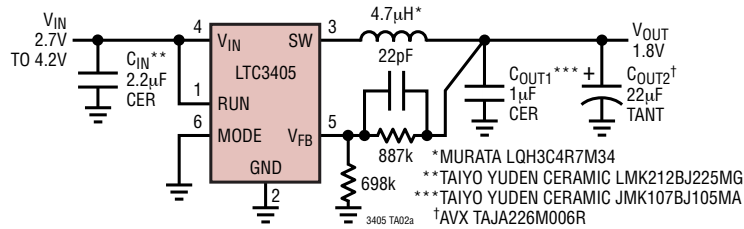

3405 TA02b

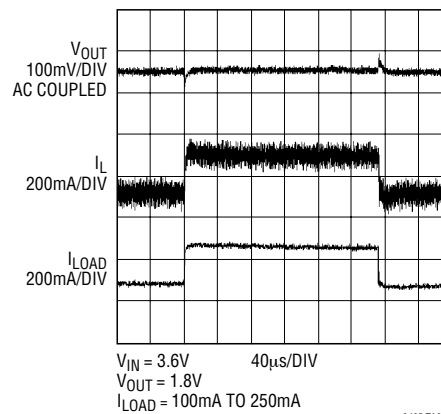

3405 TA02c

Single Li-Ion to 1.8V/200mA Regulator
Using All Ceramic Capacitors Optimized for Smallest Footprint

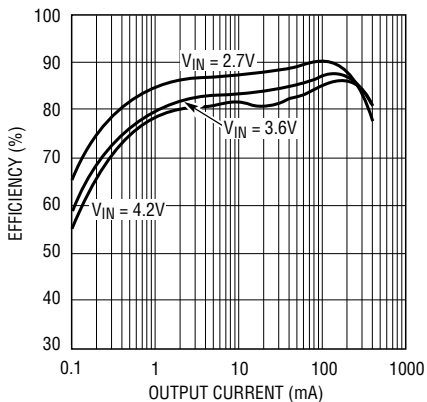
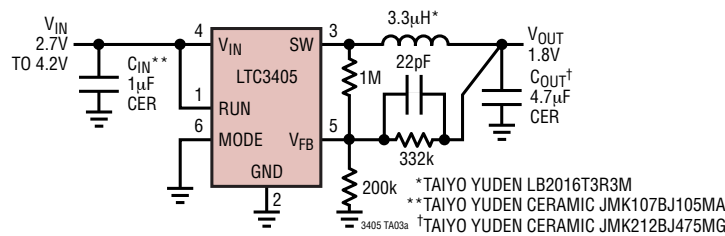

3405 TA03b

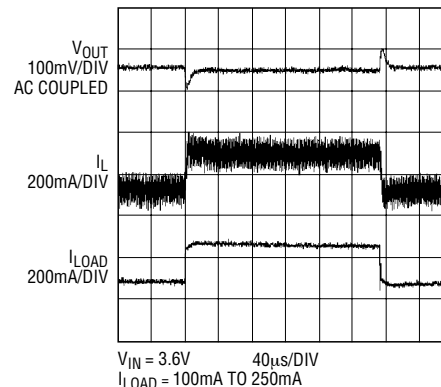

3405 TA03c

TYPICAL APPLICATIONS

Single Li-Ion to 1.8V/300mA Regulator Using All Ceramic Capacitors Optimized for Lowest Profile, $\leq 1.2\text{mm}$ High

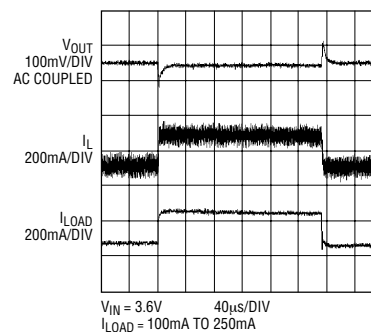
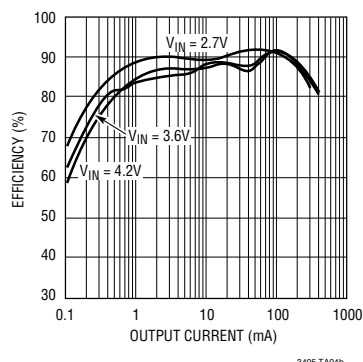
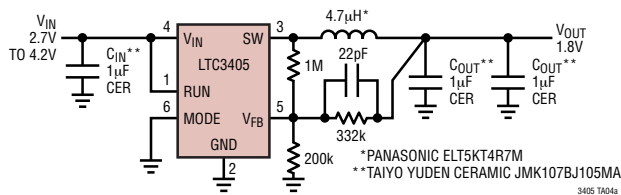

PACKAGE DESCRIPTION

S6 Package 6-Lead Plastic TSOT-23 (Reference LTC DWG # 05-08-1636)

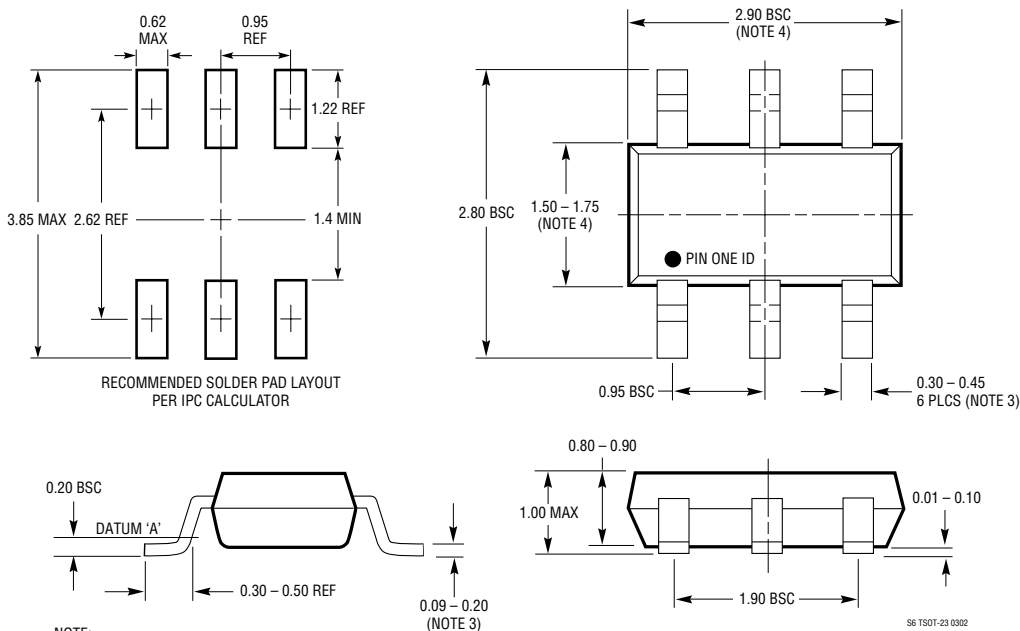

TYPICAL APPLICATIONS

Single Li-Ion to 1.8V/300mA Regulator All Ceramic Capacitors with Lowest Parts Count

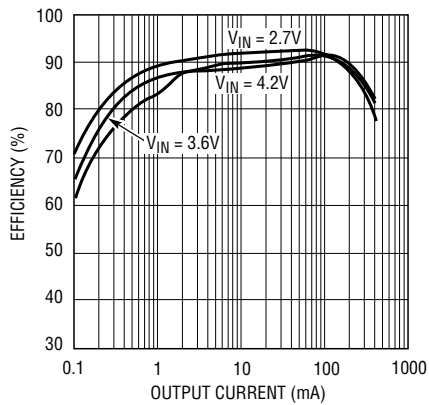
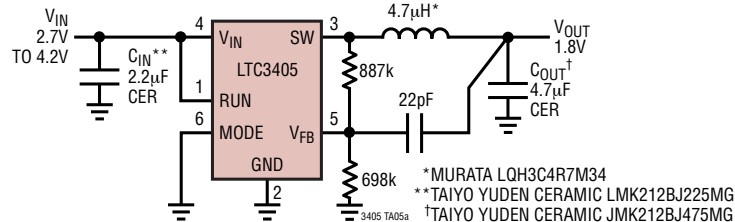

3405 TA05b

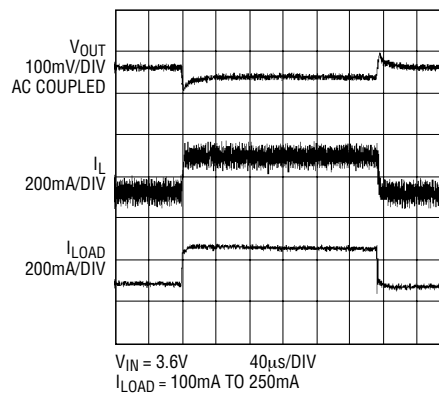

3405 TA05c

RELATED PARTS

PART NUMBER	DESCRIPTION	COMMENTS
LTC1174/LTC1174-3.3 LTC1174-5	High Efficiency Step-Down and Inverting DC/DC Converters	Monolithic Switching Regulators, I _{OUT} to 450mA, Burst Mode Operation
LTC1265	1.2A, High Efficiency Step-Down DC/DC Converter	Constant Off-Time, Monolithic, Burst Mode Operation
LTC1474/LTC1475	Low Quiescent Current Step-Down DC/DC Converters	Monolithic, I _{OUT} to 250mA, I _Q = 10µA, 8-Pin MSOP
LTC1504A	Monolithic Synchronous Step-Down Switching Regulator	Low Cost, Voltage Mode I _{OUT} to 500mA, V _{IN} from 4V to 10V
LT1616	600mA, 1.4MHz Step-Down DC/DC Converter	6-Pin ThinSOT, V _{IN} from 3.6V to 25V
LTC1627	Monolithic Synchronous Step-Down Switching Regulator	Constant Frequency, I _{OUT} to 500mA, Secondary Winding Regulation, V _{IN} from 2.65V to 8.5V
LTC1701	Monolithic Current Mode Step-Down Switching Regulator	Constant Off-Time, I _{OUT} to 500mA, 1MHz Operation, V _{IN} from 2.5V to 5.5V
LTC1707	Monolithic Synchronous Step-Down Switching Regulator	1.19V V _{REF} Pin, Constant Frequency, I _{OUT} to 600mA, V _{IN} from 2.65V to 8.5V
LTC1767	1.5A, 1.25MHz Step-Down Switching Regulator	3V to 25V Input, 8-Lead MSOP Package
LTC1779	Monolithic Current Mode Step-Down Switching Regulator	550kHz, 6-Lead ThinSOT, V _{IN} from 2.5V to 9.8V
LTC1877	High Efficiency Monolithic Step-Down Regulator	550kHz, MS8, V _{IN} Up to 10V, I _Q = 10µA, I _{OUT} to 600mA at V _{IN} = 5V
LTC1878	High Efficiency Monolithic Step-Down Regulator	550kHz, MS8, V _{IN} Up to 6V, I _Q = 10µA, I _{OUT} to 600mA at V _{IN} = 3.3V
LTC3404	1.4MHz High Efficiency Monolithic Step-Down Regulator	1.4MHz, MS8, V _{IN} Up to 6V, I _Q = 10µA, I _{OUT} to 600mA at V _{IN} = 3.3V
LTC3405A	1.5MHz High Efficiency Monolithic Step-Down Regulator	Stable with Ceramic Output Capacitor
LTC3405A-1.5/ LTC3405A-1.8	1.5MHz High Efficiency Monolithic Step-Down Regulator	Fixed Output Version of LTC3405A

3405fa