

2GHz to 14GHz Microwave Mixer with Wideband DC–6GHz IF

FEATURES

- Upconversion or Downconversion
- High IIP3: +24.4dBm at 5.8GHz
+21.4dBm at 9GHz
- 7.1dB Conversion Loss at 5.8GHz
- +15.2dBm Input P1dB at 5.8GHz
- Integrated LO Buffer: 0dBm LO Drive
- Selectable Integrated LO Frequency Doubler
- Low LO-RF Leakage: -30dBm
- 50Ω Wideband Matched RF and LO Ports
- 3.3V/120mA Supply
- Fast Turn ON/OFF for TDD Operation
- 3mm × 2mm, 12-Lead QFN Package

APPLICATIONS

- Microwave Transceivers
- Wireless Backhaul
- Point-to-Point Microwave
- Phased-Array Antennas
- C, X and Ku Band RADAR
- Test Equipment
- Satellite MODEMs

DESCRIPTION

The LTC[®]5548 is a high performance, microwave double balanced passive mixer that can be used for frequency upconversion or downconversion. The device is similar to the LTC5549, but with a broadband, differential DC to 6GHz IF port. The LTC5548 is recommended for applications where the IF frequency range extends below 500MHz. For applications where the IF frequency is always above 500MHz, the LTC5549 is recommended, since it includes an integrated IF balun.

The LTC5548's mixer and integrated RF balun are optimized to cover the 2GHz to 14GHz RF frequency range. The device includes an integrated LO amplifier optimized for the 1GHz to 12GHz frequency range, requiring only 0dBm drive. The device also includes an integrated LO frequency doubler, which can be enabled or disabled with a CMOS-compatible control pin.

The LTC5548 delivers exceptionally high IIP3 and P1dB, in addition to very low LO to RF and LO to IF leakages. The part also offers high integration in a small package.

LT, LT, LTC, LTM, Linear Technology and the Linear logo are registered trademarks of Linear Technology Corporation. All other trademarks are the property of their respective owners.

TYPICAL APPLICATION

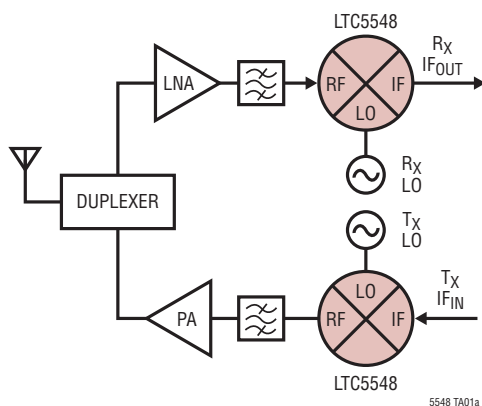

5548 TA01a

**Conversion Loss and IIP3
(Low Side LO, IF = 240MHz)**

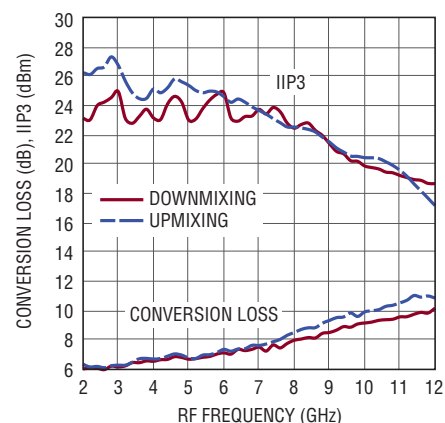

5548 TA01b

LTC5548

ABSOLUTE MAXIMUM RATINGS

(Note 1)

Supply Voltage (V_{CC})	4V
Enable Input Voltage (EN)	-0.3V to $V_{CC} + 0.3V$
X2 Input Voltage (X2)	-0.3V to $V_{CC} + 0.3V$
LO Input Power (1GHz to 12GHz)	+10dBm
LO Input DC Voltage	$\pm 0.1V$
RF Power (2GHz to 14GHz)	+20dBm
RF DC Voltage	$\pm 0.1V$
IF ⁺ /IF ⁻ Input Power (LF to 6GHz)	+20dBm
IF ⁺ /IF ⁻ Input DC Voltage	$\pm 0.3V$
Operating Temperature Range (T_C)	-40°C to 105°C
Storage Temperature Range	-65°C to 150°C
Junction Temperature (T_J)	150°C

PIN CONFIGURATION

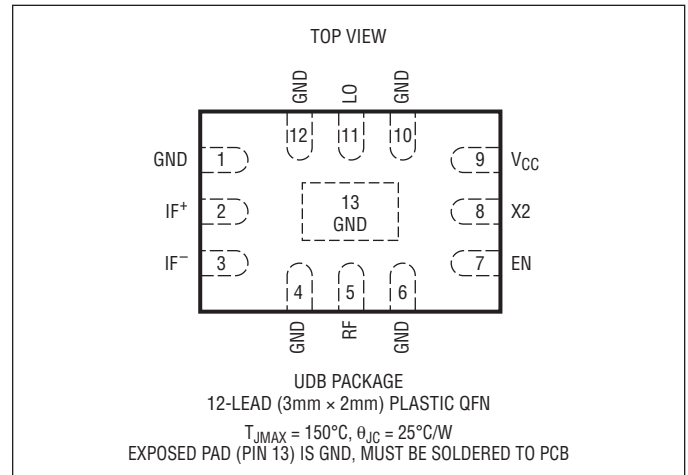

ORDER INFORMATION

(<http://www.linear.com/product/LTC5548#orderinfo>)

Lead Free Finish

TAPE AND REEL (MINI)	TAPE AND REEL	PART MARKING	PACKAGE DESCRIPTION	TEMPERATURE RANGE
LTC5548IUDB#TRMPBF	LTC5548IUDB#TRPBF	LGXF	12-Lead (3mm x 2mm) Plastic QFN	-40°C to 105°C

TRM = 500 pieces.

Consult LTC Marketing for parts specified with wider operating temperature ranges.

For more information on lead free part marking, go to: <http://www.linear.com/leadfree/>

For more information on tape and reel specifications, go to: <http://www.linear.com/tapeandreel/>. Some packages are available in 500 unit reels through designated sales channels with #TRMPBF suffix.

DC ELECTRICAL CHARACTERISTICS The ● denotes the specifications which apply over the full operating temperature range, otherwise specifications are at $T_C = 25^\circ\text{C}$. $V_{CC} = 3.3V$, EN = High, unless otherwise noted. Test circuit shown in Figure 1. (Note 2)

PARAMETER	CONDITIONS	MIN	TYP	MAX	UNITS
Power Supply Requirements					
Supply Voltage (V_{CC})		● 3.0	3.3	3.6	V
Supply Current Enabled	X2 = Low (LO Doubler Off) X2 = High (LO Doubler On)		120 136	140 160	mA mA
Shutdown Current	EN = Low			100	μA
Enable (EN) and LO Frequency Doubler (X2) Logic Inputs					
Input High Voltage (On)		● 1.2			V
Input Low Voltage (Off)		●		0.3	V
Input Current	-0.3V to $V_{CC} + 0.3V$	-30		100	μA
Chip Turn-On Time			0.2		μs
Chip Turn-Off Time			0.1		μs

AC ELECTRICAL CHARACTERISTICS The ● denotes the specifications which apply over the full operating temperature range, otherwise specifications are at $T_C = 25^\circ\text{C}$. $V_{CC} = 3.3\text{V}$, EN = High, $P_{LO} = 0\text{dBm}$, $P_{RF} = -5\text{dBm}$ ($-5\text{dBm}/\text{tone}$ for two-tone IIP3 tests), unless otherwise noted. Test circuit shown in Figure 1. (Notes 2, 3)

PARAMETER	CONDITIONS	MIN	TYP	MAX	UNITS
LO Frequency Range	●		1 to 12		GHz
RF Frequency Range	●		2 to 14		GHz
IF Frequency Range	●		DC to 6000		MHz
RF Return Loss	$Z_0 = 50\Omega$, 2GHz to 13.6GHz		>9		dB
LO Input Return Loss	$Z_0 = 50\Omega$, 1GHz to 12GHz		>10		dB
LO Input Power	X2 = Low	-6	0	6	dBm
	X2 = High	-6	0	3	dBm

Downmixer Application with LO Doubler Off (X2 = Low), IF = 240MHz, Low Side LO

Conversion Loss	RF Input = 2GHz		6.0		dB
	RF Input = 5.8GHz		7.1		dB
	RF Input = 9GHz		8.5		dB
	RF Input = 12GHz		10.2		dB
Conversion Loss vs Temperature	$T_C = -40^\circ\text{C}$ to 105°C , RF Input = 5.8GHz	●	0.006		dB/ $^\circ\text{C}$
2-Tone Input 3rd Order Intercept ($\Delta f_{RF} = 2\text{MHz}$)	RF Input = 2GHz		23.1		dBm
	RF Input = 5.8GHz		24.4		dBm
	RF Input = 9GHz		21.4		dBm
	RF Input = 12GHz		18.7		dBm
SSB Noise Figure	RF Input = 2GHz		6.2		dB
	RF Input = 5.8GHz		8.0		dB
	RF Input = 8.5GHz		9.6		dB
LO to RF Leakage	$f_{LO} = 1\text{GHz}$ to 12GHz		<-25		dBm
LO to IF Leakage	$f_{LO} = 1\text{GHz}$ to 12GHz		<-26		dBm
RF to LO Isolation	$f_{RF} = 2\text{GHz}$ to 14GHz		>40		dB
RF Input to IF Output Isolation	$f_{RF} = 2\text{GHz}$ to 14GHz		>35		dB
Input 1dB Compression	RF Input = 5.8GHz		15.2		dBm

Downmixer Application with LO Doubler On (X2 = High), IF = 240MHz, Low Side LO

Conversion Loss	RF Input = 5.8GHz		7.3		dB
	RF Input = 9GHz		9.2		dB
	RF Input = 12GHz		11.8		dB
Conversion Loss vs. Temperature	$T_C = -40^\circ\text{C}$ to 105°C , RF Input = 5.8GHz	●	0.006		dB/ $^\circ\text{C}$
2-Tone Input 3rd Order Intercept ($\Delta f_{RF} = 2\text{MHz}$)	RF Input = 5.8GHz		23.9		dBm
	RF Input = 9GHz		20.9		dBm
	RF Input = 12GHz		18.3		dBm
SSB Noise Figure	RF Input = 5.8GHz		8.9		dB
	RF Input = 8.5GHz		10.8		dB
LO to RF Input Leakage	$f_{LO} = 1\text{GHz}$ to 5GHz		<-30		dBm
2LO to RF Input Leakage	$f_{LO} = 1\text{GHz}$ to 5GHz		\leq -25		dBm
LO to IF Output Leakage	$f_{LO} = 1\text{GHz}$ to 5GHz		<-36		dBm
2LO to IF Output Leakage	$f_{LO} = 1\text{GHz}$ to 5GHz		<-20		dBm
Input 1dB Compression	$f_{RF} = 5.8\text{GHz}$		14.8		dBm

AC ELECTRICAL CHARACTERISTICS The ● denotes the specifications which apply over the full operating temperature range, otherwise specifications are at $T_C = 25^\circ\text{C}$. $V_{CC} = 3.3\text{V}$, EN = High, $P_{LO} = 0\text{dBm}$, $P_{IF} = -5\text{dBm}$ (-5dBm/tone for two-tone IIP3 tests), unless otherwise noted. Test circuit shown in Figure 1. (Notes 2, 3)

PARAMETER	CONDITIONS	MIN	TYP	MAX	UNITS
Upmixer Application with LO Doubler Off (X2 = Low), IF = 240MHz, Low Side LO					
Conversion Loss	RF Output = 2GHz		6.3		dB
	RF Output = 5.8GHz		7.1		dB
	RF Output = 9GHz		9.3		dB
	RF Output = 12GHz		10.9		dB
Conversion Loss vs Temperature	$T_C = -40^\circ\text{C}$ to 105°C , RF Output = 5.8GHz		0.006		dB/ $^\circ\text{C}$
Input 3rd Order Intercept ($\Delta f_{IF} = 2\text{MHz}$)	RF Output = 2GHz		26.3		dBm
	RF Output = 5.8GHz		24.9		dBm
	RF Output = 9GHz		21.5		dBm
	RF Output = 12GHz		17.2		dBm
SSB Noise Figure	RF Output = 2GHz		7.8		dB
	RF Output = 5.8GHz		8.7		dB
	RF Output = 8.5GHz		10.4		dB
LO to RF Output Leakage	$f_{LO} = 1\text{GHz}$ to 12GHz		<-25		dBm
LO to IF Input Leakage	$f_{LO} = 1\text{GHz}$ to 12GHz		<-26		dBm
IF to LO Isolation	$f_{IF} = 500\text{MHz}$ to 6GHz		>50		dB
IF to RF Isolation	$f_{IF} = 500\text{MHz}$ to 6GHz		>40		dB
Input 1dB Compression	RF Output = 5.8GHz		15.7		dBm
Upmixer Application with LO Doubler On (X2 = High), IF = 240MHz, Low Side LO					
Conversion Loss	RF Output = 5.8GHz		7.4		dB
	RF Output = 9GHz		9.6		dB
	RF Output = 12GHz		12.1		dB
Conversion Loss vs Temperature	$T_C = -40^\circ\text{C}$ to 105°C , RF Output = 5.8GHz		0.006		dB/ $^\circ\text{C}$
2-Tone Input 3rd Order Intercept ($\Delta f_{IF} = 2\text{MHz}$)	RF Output = 5.8GHz		24.9		dBm
	RF Output = 9GHz		21.3		dBm
	RF Output = 12GHz		16.8		dBm
SSB Noise Figure	RF Output = 5.8GHz		10.4		dB
	RF Output = 9GHz		12.4		dB
LO to RF Output Leakage	$f_{LO} = 1\text{GHz}$ to 5GHz		<-30		dBm
2LO to RF Output Leakage	$f_{LO} = 1\text{GHz}$ to 5GHz		<-25		dBm
LO to IF Input Leakage	$f_{LO} = 1\text{GHz}$ to 5GHz		<-36		dBm
2LO to IF Input Leakage	$f_{LO} = 1\text{GHz}$ to 5GHz		<-20		dBm
Input 1dB Compression	RF Output = 5.8GHz		14.8		dBm

Note 1: Stresses beyond those listed under Absolute Maximum Ratings may cause permanent damage to the device. Exposure to any Absolute Maximum Rating condition for extended periods may affect device reliability and lifetime.

Note 2: The LTC5548 is guaranteed functional over the -40°C to 105°C case temperature range ($\theta_{JC} = 25^\circ\text{C/W}$).

Note 3: SSB noise figure measurements performed with a small-signal noise source, bandpass filter and 2dB matching pad on input, with bandpass filters on LO, and output.

TYPICAL PERFORMANCE CHARACTERISTICS EN = high, test circuit shown in Figure 1.

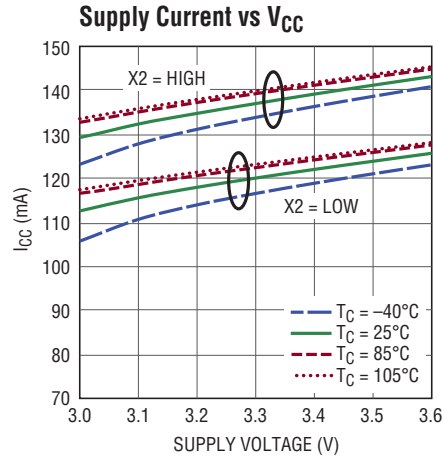
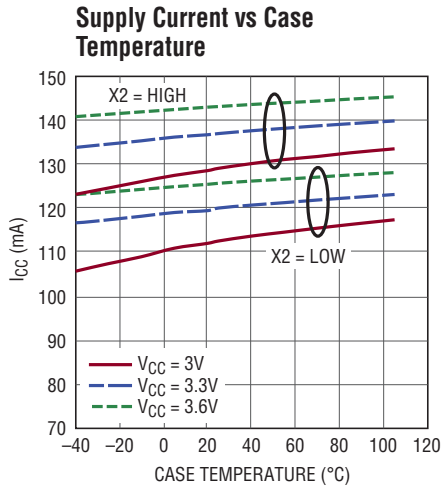

TYPICAL PERFORMANCE CHARACTERISTICS 2GHz to 12GHz downmixer application.
 $V_{CC} = 3.3V$, EN = high, X2 = low, $T_C = 25^\circ C$, $P_{LO} = 0dBm$, $P_{RF} = -5dBm$ (-5dBm/tone for two-tone IIP3 tests, $\Delta f = 2MHz$), IF = 240MHz, unless otherwise noted. Test circuit shown in Figure 1.

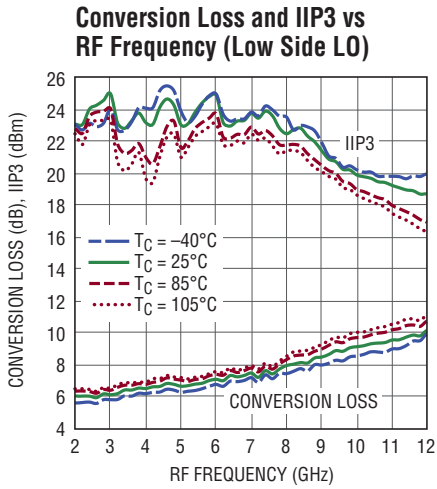

5548 G03

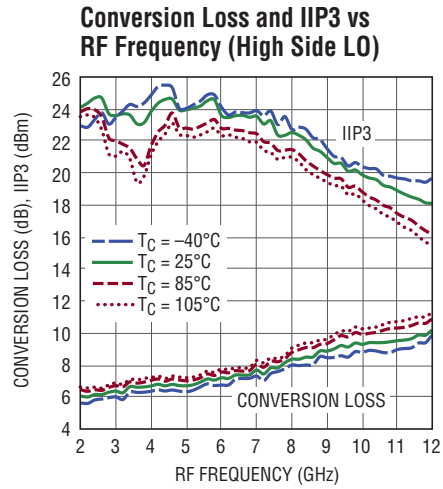

5548 G04

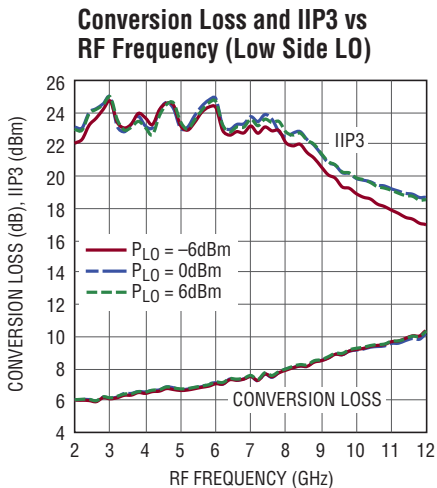

5548 G05

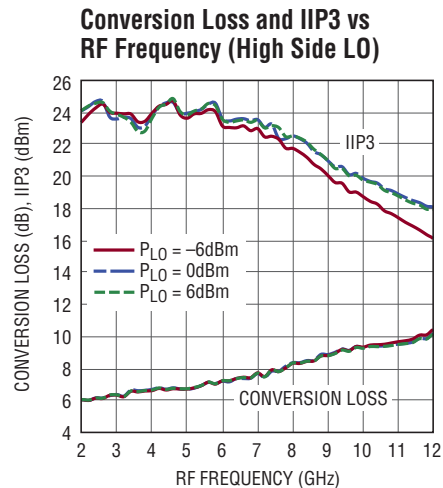

5548 G06

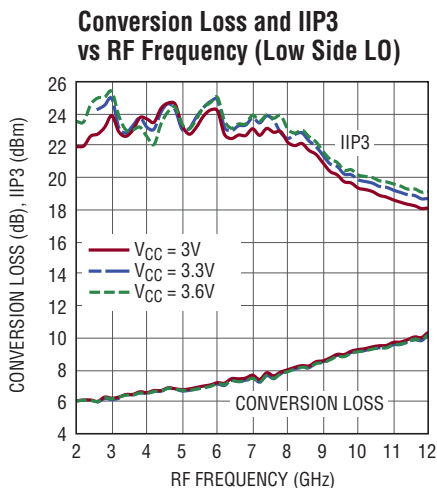

5548 G07

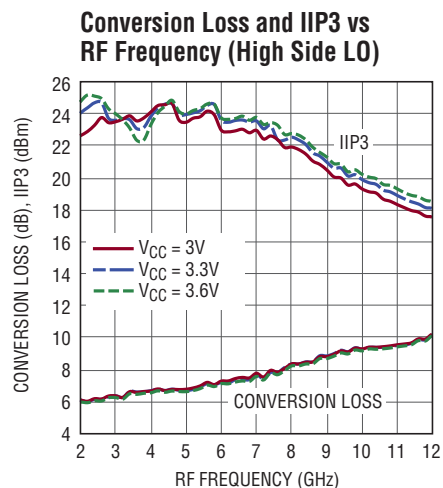

5548 G08

TYPICAL PERFORMANCE CHARACTERISTICS 2GHz to 12GHz downmixer application.
 $V_{CC} = 3.3V$, EN = high, X2 = low, $T_C = 25^\circ C$, $P_{LO} = 0dBm$, $P_{RF} = -5dBm$ (-5dBm/tone for two-tone IIP3 tests, $\Delta f = 2MHz$), IF = 240MHz, unless otherwise noted. Test circuit shown in Figure 1.

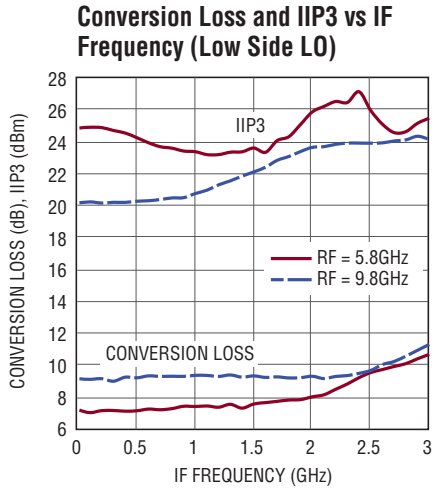

5548 G09

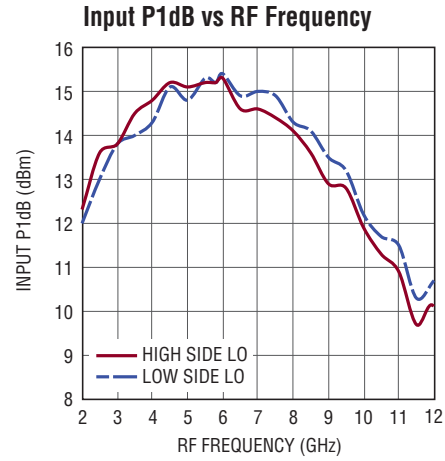

5548 G10

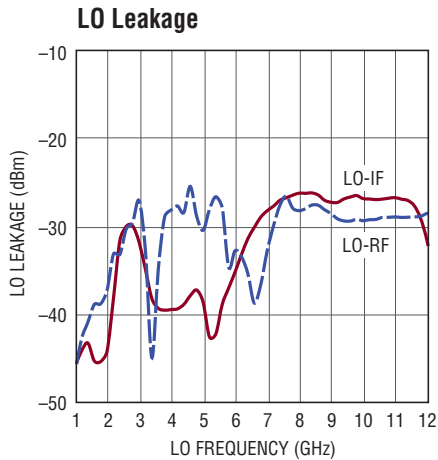

5548 G11

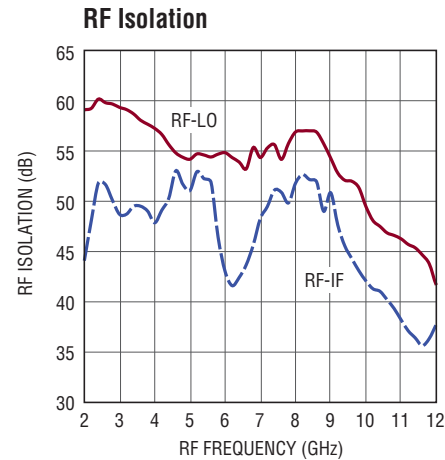

5548 G12

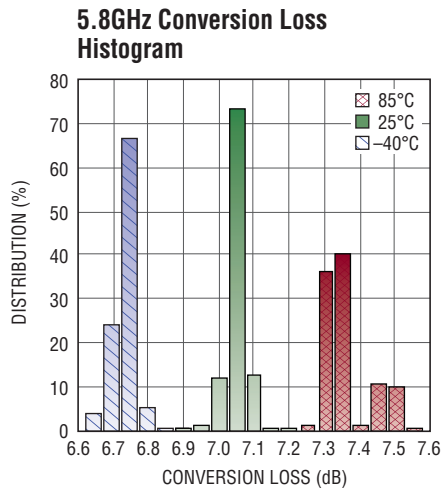

5548 G13

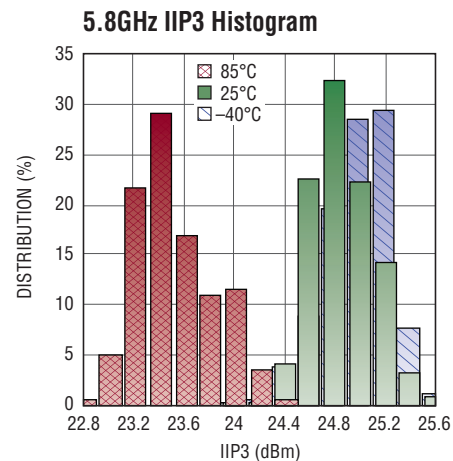

5548 G14

TYPICAL PERFORMANCE CHARACTERISTICS

2GHz to 12GHz downmixer application with LO frequency doubler enabled. $V_{CC} = 3.3V$, EN = high, X2 = high, $T_C = 25^\circ C$, $P_{LO} = 0dBm$, $P_{RF} = -5dBm$ (-5dBm/tone for two-tone IIP3 tests, $\Delta f = 2MHz$), IF = 240MHz, unless otherwise noted. Test circuit shown in Figure 1.

Conversion Loss and IIP3 vs RF Frequency (Low Side LO)

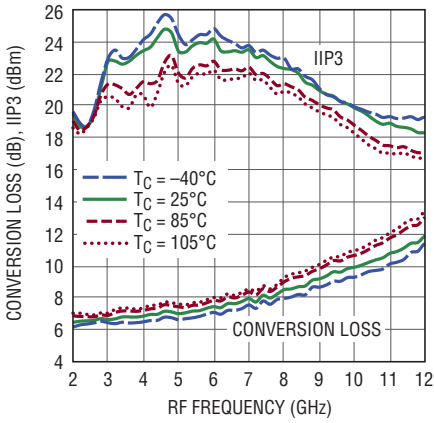

5548 G15

Conversion Loss and IIP3 vs RF Frequency (Low Side LO)

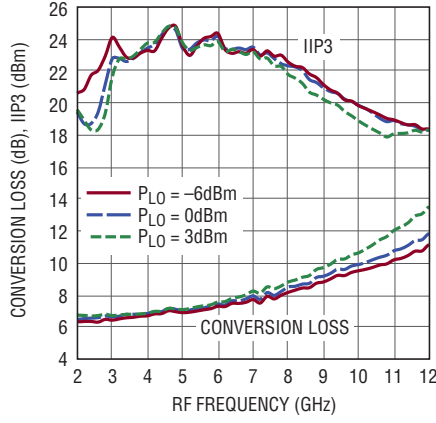

5548 G14

Conversion Loss and IIP3 vs RF Frequency (Low Side LO)

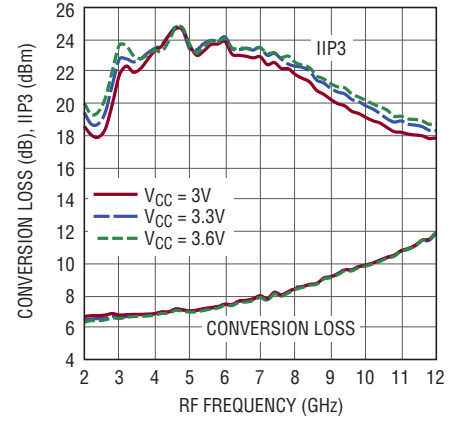

5548 G15

Conversion Loss and IIP3 vs RF Frequency (High Side LO)

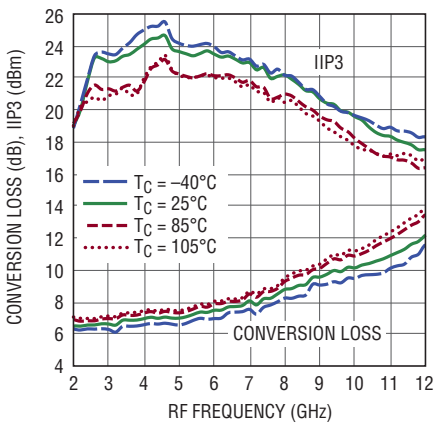

5548 G16

Conversion Loss and IIP3 vs RF Frequency (High Side LO)

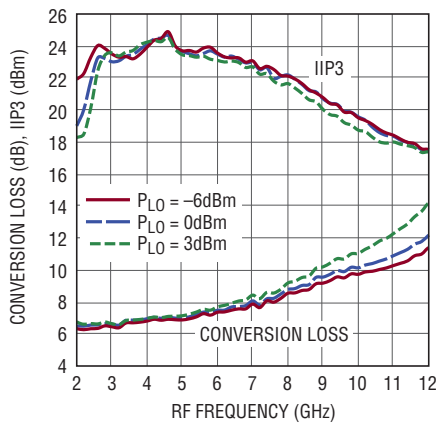

5548 G17

Conversion Loss and IIP3 vs RF Frequency (High Side LO)

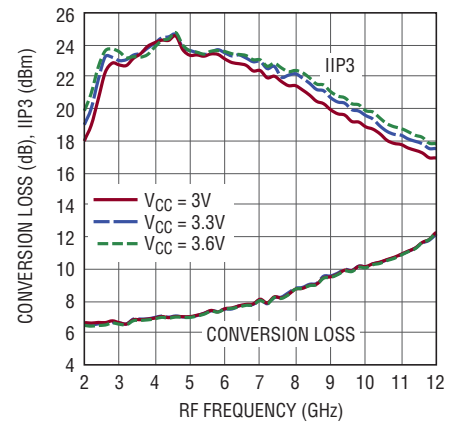

5548 G18

Conversion Loss and IIP3 vs IF Frequency (Low Side LO)

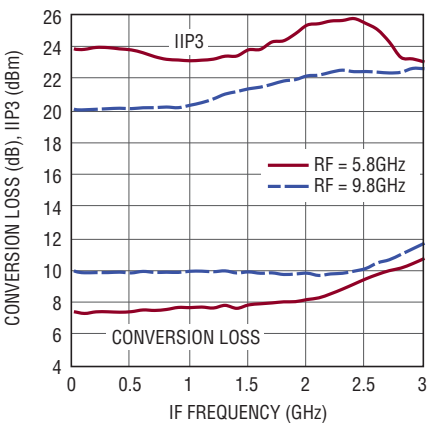

5548 G19

Input P1dB vs RF Frequency

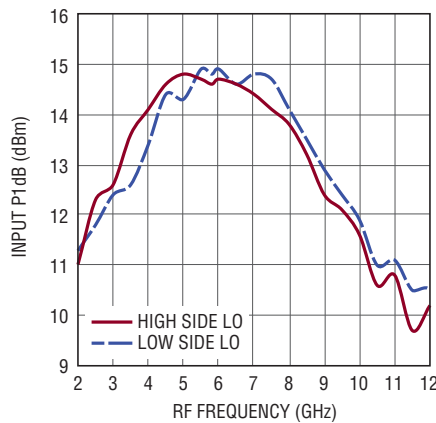

5548 G20

LO and 2LO Leakage to IF

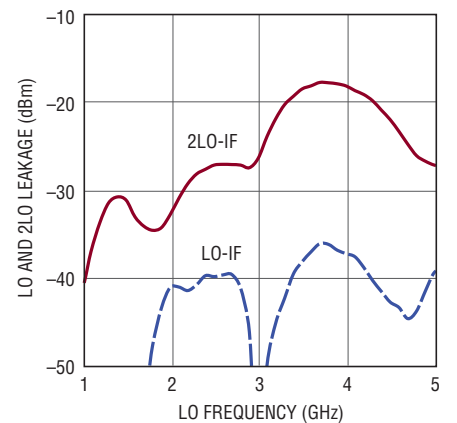

5548 G21

TYPICAL PERFORMANCE CHARACTERISTICS 2GHz to 12GHz upmixer application.
 $V_{CC} = 3.3V$, EN = high, X2 = low, $T_C = 25^\circ C$, $P_{LO} = 0dBm$, $P_{IF} = -5dBm$ (-5dBm/tone for two-tone IIP3 tests, $\Delta f = 2MHz$), IF = 240MHz, unless otherwise noted. Test circuit shown in Figure 1.

Conversion Loss and IIP3 vs RF Frequency (Low Side LO)

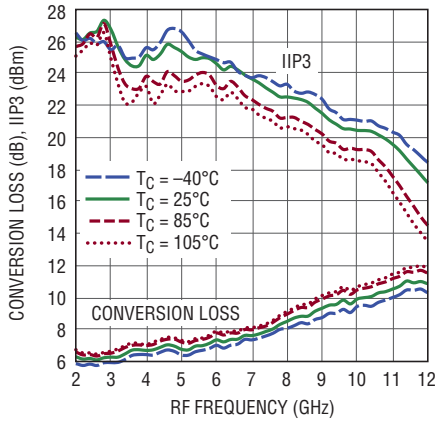

5548 G22

Conversion Loss and IIP3 vs RF Frequency (Low Side LO)

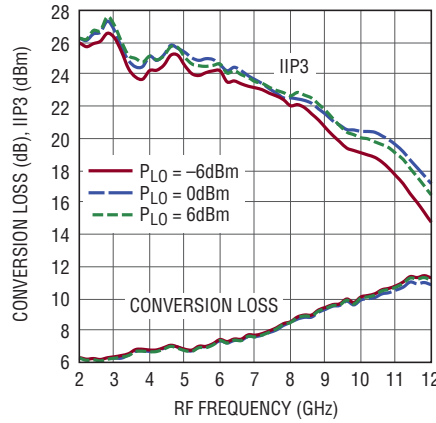

5548 G23

Conversion Loss and IIP3 vs RF Frequency (Low Side LO)

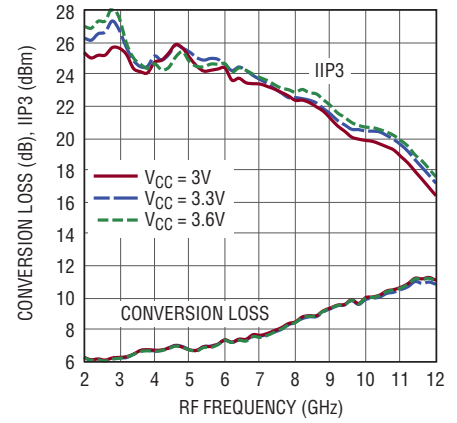

5548 G24

Conversion Loss and IIP3 vs RF Frequency (High Side LO)

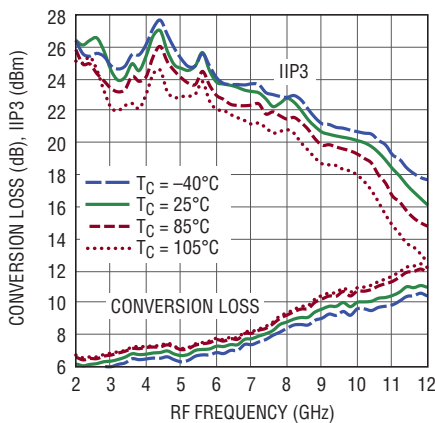

5548 G25

Conversion Loss and IIP3 vs RF Frequency (High Side LO)

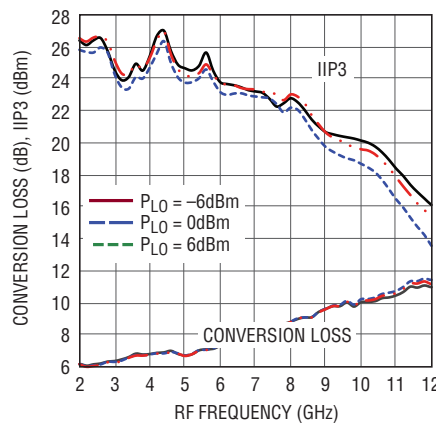

5548 G26

Conversion Loss and IIP3 vs RF Frequency (High Side LO)

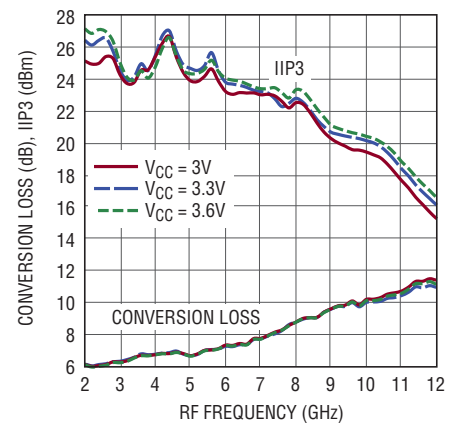

5548 G27

Conversion Loss and IIP3 vs IF Frequency (Low Side LO)

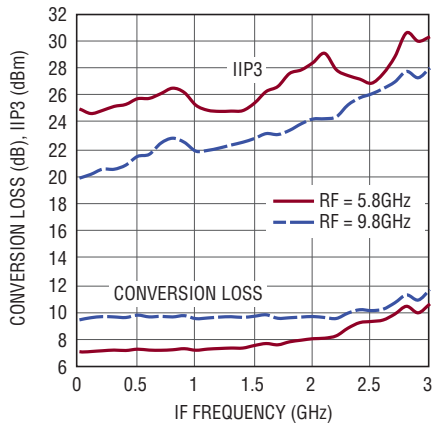

5548 G28

Input P1dB vs IF Frequency

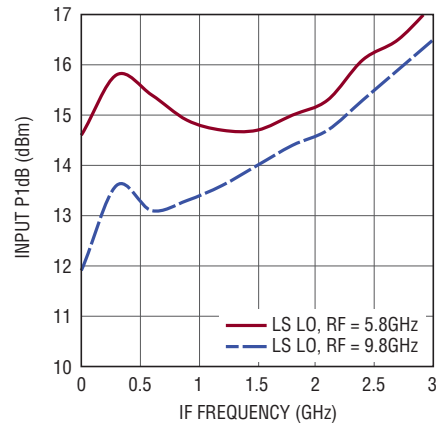

5548 G29

IF Isolation

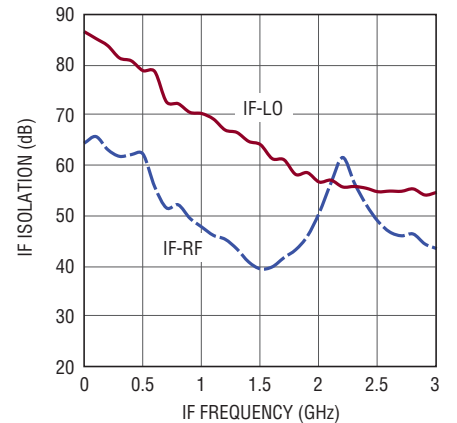

5548 G30

TYPICAL PERFORMANCE CHARACTERISTICS 2GHz to 12GHz upmixer application with LO frequency doubler enabled. $V_{CC} = 3.3V$, EN = high, X2 = high, $T_C = 25^\circ C$, $P_{LO} = 0dBm$, $P_{IF} = -5dBm$ (-5dBm/tone for two-tone IIP3 tests, $\Delta f = 2MHz$), output measured at 5.8GHz, unless otherwise noted. Test circuit shown in Figure 1.

Conversion Loss and IIP3 vs RF Frequency (Low Side LO)

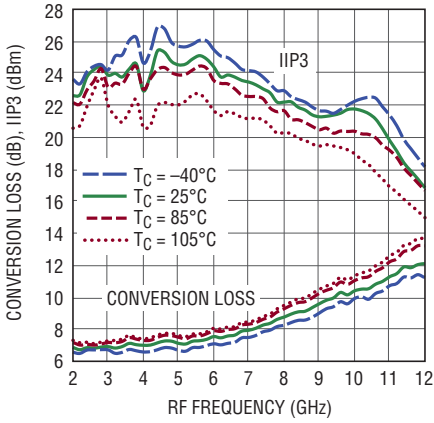

5548 G31

Conversion Loss and IIP3 vs RF Frequency (Low Side LO)

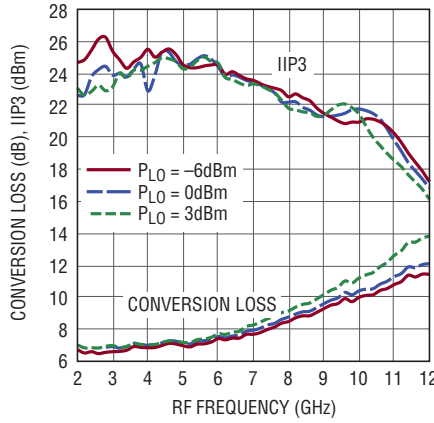

5548 G32

Conversion Loss and IIP3 vs RF Frequency (Low Side LO)

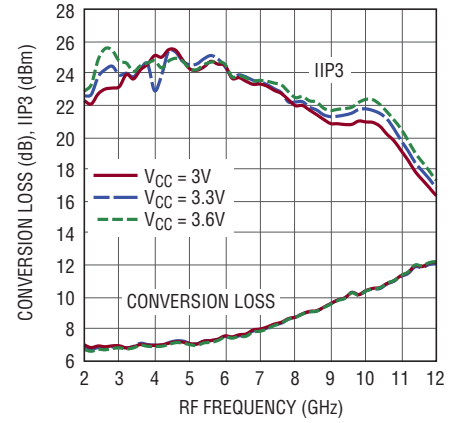

5548 G33

Conversion Loss and IIP3 vs RF Frequency (High Side LO)

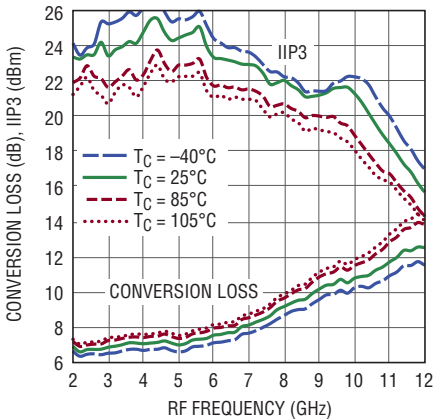

5548 G34

Conversion Loss and IIP3 vs RF Frequency (High Side LO)

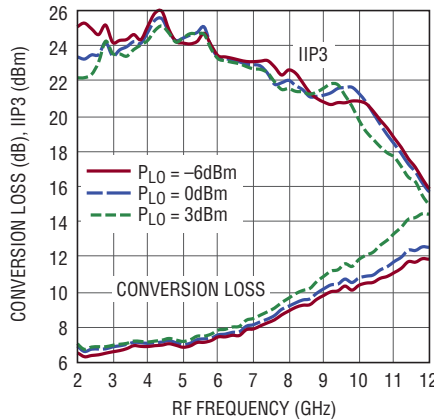

5548 G35

Conversion Loss and IIP3 vs RF Frequency (High Side LO)

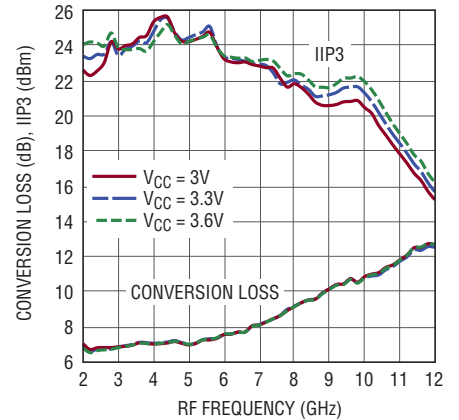

5548 G33

Conversion Loss and IIP3 vs IF Frequency (Low Side LO)

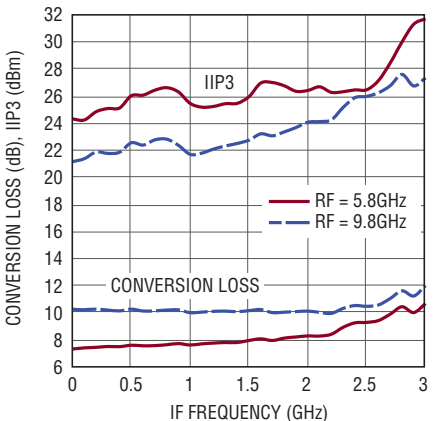

5548 G37

Input P1dB vs IF Frequency

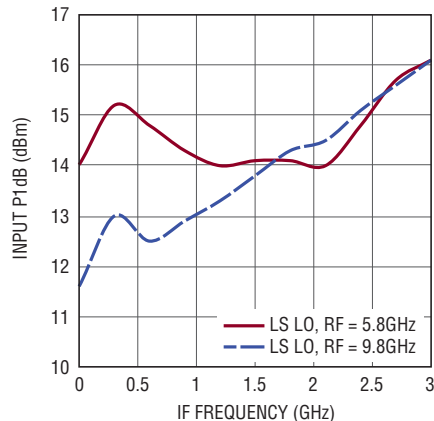

5548 G38

LO and 2LO Leakage to RF

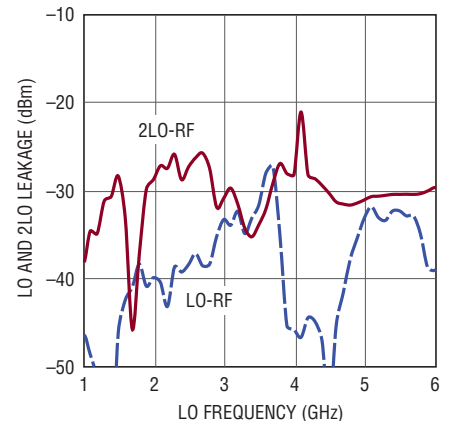

5548 G39

PIN FUNCTIONS

GND (Pins 1, 4, 6, 10, 12, Exposed Pad Pin 13): Ground. These pins must be soldered to the RF ground on the circuit board. The exposed pad metal of the package provides both electrical contact to ground and good thermal contact to the printed circuit board.

IF⁺, IF⁻ (Pins 2, 3): Differential Terminals for the IF. These pins may be used for a differential IF or connected to an external balun if a single-ended IF port is needed. The IF port can be used from DC up to 6GHz depending on the external balun bandwidth.

RF (Pin 5): Single-Ended Terminal for the RF Port. This pin is internally connected to the primary side of the RF transformer, which has low DC resistance to ground. A series DC blocking capacitor must be used to avoid damage to the integrated transformer if DC voltage is present. The RF port is impedance matched from 2GHz to 14GHz as long as the LO is driven with a $0 \pm 6\text{dBm}$ source between 1GHz and 12GHz.

EN (Pin 7): Enable Pin. When the voltage applied to this pin is greater than 1.2V, the mixer is enabled. When the voltage is less than 0.3V, the mixer is disabled. Typical input current is less than $30\mu\text{A}$. This pin has an internal $376\text{k}\Omega$ pull-down resistor.

X2 (Pin 8): Digital Control Pin for LO Frequency Doubler. When the voltage applied to this pin is greater than 1.2V, the LO frequency doubler is enabled. When the voltage DC is less than 0.3V, the LO frequency doubler is disabled. Typical input current is less than $30\mu\text{A}$. This pin has an internal $376\text{k}\Omega$ pull-down resistor.

V_{CC} (Pin 9): Power Supply Pin. This pin must be externally connected to a regulated 3.3V supply, with a bypass capacitor located close to the pin. Typical current consumption is 120mA when the part is enabled.

LO (Pin 11): Input for the Local Oscillator (LO). A series DC blocking capacitor must be used. Typical DC voltage at this pin is 1.6V.

BLOCK DIAGRAM

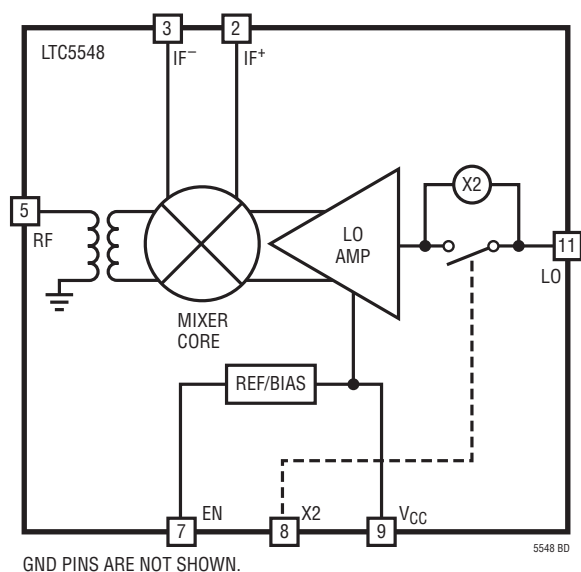

TEST CIRCUIT

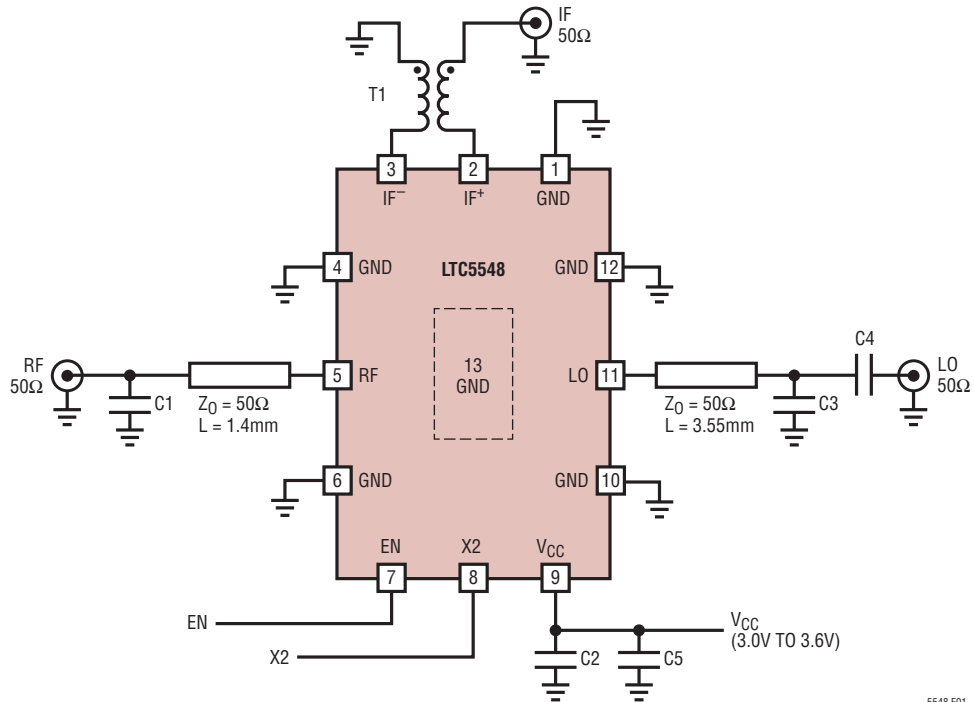

5548 F01

REF DES	VALUE	SIZE	VENDOR	COMMENT
C1, C3	0.15pF	0402	AVX	ACCU-P 04021JR15ZBS
C2, C4	22pF	0402	AVX	0402A220JAT2A
C5	1μF	0603	Murata	GRM188R71A105KA61
T1	TC1-1-13M+ *		Mini Circuits	IF = 4.5MHz to 3GHz
	TCM1-83X+		Mini Circuits	IF = 10MHz to 6GHz

* Standard Evaluation Board Configuration

Figure 1. Standard Test Circuit Schematic

APPLICATIONS INFORMATION

Introduction

The LTC5548 consists of a high linearity double-balanced mixer core, LO buffer amplifier, LO frequency doubler and bias/enable circuits. See the Block Diagram section for a description of each pin function. The RF and LO are single-ended terminals. The IF is differential. An external balun is needed if a single-ended IF signal is desired. The LTC5548 can be used as a frequency downconverter where the RF is used as an input and IF is used as an output. It can also be used as a frequency upconverter where the IF is used as an input and RF is used as an output. Low side or high side LO injection can be used. The evaluation circuit and the evaluation board layout are shown in Figure 1 and Figure 2, respectively.

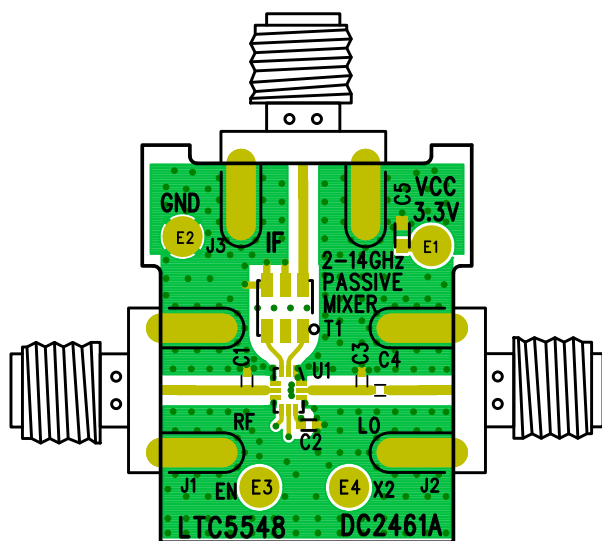

Figure 2. Evaluation Board Layout

RF Port

The mixer's RF port, shown in Figure 3, is connected to the primary winding of an integrated transformer. The primary side of the RF transformer is DC-grounded internally and the DC resistance of the primary side is approximately 3.2Ω. A DC blocking capacitor is needed if the RF source has DC voltage present. The secondary winding of the RF transformer is internally connected to the mixer core.

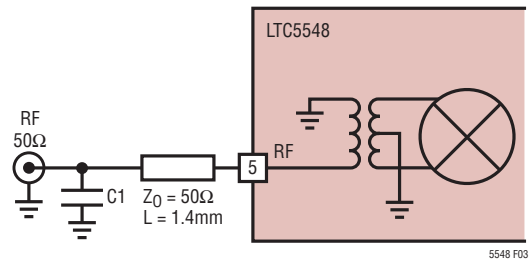
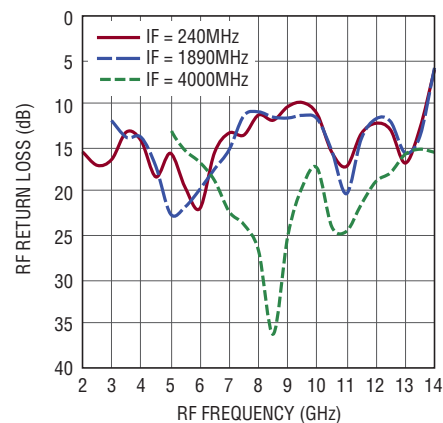
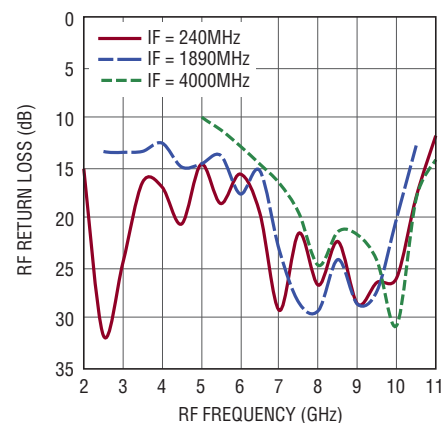

Figure 3. Simplified RF Port Interface Schematic



(a)



(b)

Figure 4. RF Port Return Loss (a) C1 = 0.15pF (b) C1 Open

APPLICATIONS INFORMATION

The RF port is broadband matched to 50Ω from 2GHz to 14GHz with a 0.15pF shunt capacitor (C1) located 1.4mm away from the RF pin. The RF port is 50Ω matched from 2GHz to 10GHz without C1. An LO between -6dBm and 6dBm is required for good RF impedance matching. The measured RF input return loss is shown in Figure 4 for IF frequencies of 240MHz, 1890MHz and 4GHz with low side LO.

The RF input impedance and input reflection coefficient versus RF frequency is listed in Table 1. The reference plane for this data is Pin 5 of the IC, with no external matching, and the LO is driven at 7.5GHz.

Table 1. RF Input Impedance and S11 (at Pin 5, No External Matching, LO Input Driven at 7.5GHz)

FREQUENCY (GHz)	INPUT IMPEDANCE	S11	
		MAG	ANGLE
2	34.3+j28.9	0.37	99.6
3	49.4+j24.7	0.24	77.4
4	57.2-j3.8	0.08	-25.8
5	37.7+j4.4	0.15	157.4
6	43.4+j2.2	0.07	160.2
7	46.2-j1.9	0.04	-152.3
8	47.8-j1.1	0.02	-155.0

Table 1. RF Input Impedance and S11 (at Pin 5, No External Matching, LO Input Driven at 7.5GHz)

9	48.8+j0.6	0.01	152.8
10	46.1+j9.1	0.10	107.8
11	35.8+j3.2	0.17	165.2
12	16.3+j4.1	0.51	169.5
13	10.9+j2.3	0.64	174.5
14	12.9-j3.5	0.59	-171.4

LO Input

The mixer's LO input, shown in Figure 5, consists of a single-ended to differential conversion, high speed limiting differential amplifier and an LO frequency doubler. The LO amplifier is optimized for the 1GHz to 12GHz LO frequency range. LO frequencies above or below this frequency range may be used with degraded performance. The LO frequency doubler is controlled by a digital voltage input at X2 (Pin 8). When the X2 voltage is higher than 1.2V, the LO frequency doubler is enabled. When X2 is left open or its voltage is lower than 0.3V, the LO frequency doubler is disabled.

The DC voltage at the LO input is about 1.6V. A DC blocking capacitor (C4) is required.

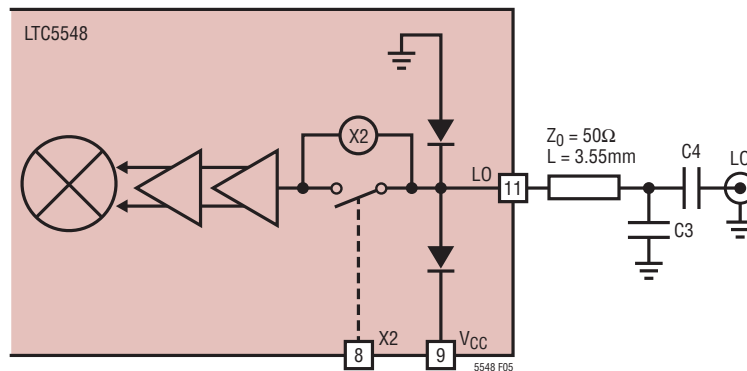

Figure 5. Simplified LO Input Schematic

APPLICATIONS INFORMATION

The LO is 50Ω matched from 1GHz to 12GHz, with a 0.15pF shunt capacitor (C3) located 3.55mm away from the LO pin. External matching components may be needed for extended LO operating frequency range. The measured LO input return loss is shown in Figure 6. The LO return loss does not change when LO frequency double is enabled. The nominal LO input level is 0dBm, although the limiting amplifiers will deliver excellent performance over a ±6dBm input power range.

The LO input impedance and input reflection coefficient versus frequency, is shown in Table 2.

Table 2. LO Input Impedance vs Frequency (at Pin 11, No External Matching)

FREQUENCY (GHz)	INPUT IMPEDANCE	S11	
		MAG	ANGLE
1	63.8-j17.4	0.19	-42.9
2	58.1-j12.7	0.14	-50.8
3	50.5-j10.8	0.11	-81.2
4	43.4-j9.1	0.12	-120.4
5	36.7+j4.6	0.16	157.9
6	30.9-j6.8	0.25	-155.6
7	28.1-j6.3	0.29	-159.3
8	28.7-j5.1	0.28	-162.8
9	28.9-j2.2	0.27	-172.5
10	26.4+j2.6	0.31	171.8
11	24.1+j3.1	0.35	170.8
12	24.3+j0.3	0.35	179.1

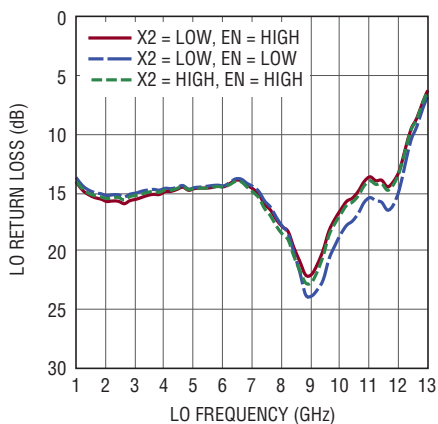

5548 F06a

(a) C3 = 0.15pF

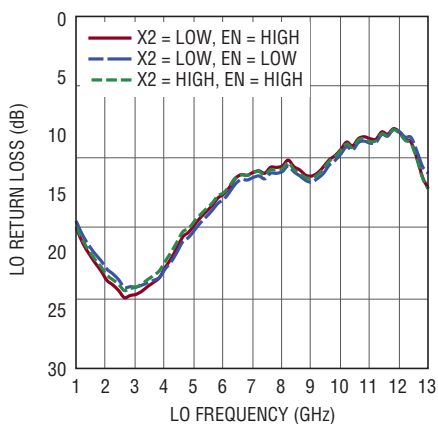

5548 F06b

(b) C3 Open

Figure 6. LO Input Return Loss

APPLICATIONS INFORMATION

IF Port

The mixer's IF port is differential as shown in Figure 7. ESD protection diodes are connected to both of these ports.

The impedance of the IF⁺ and IF⁻ terminals is approximately 25Ω in parallel with 0.25pF. An external 1:1 balun is required for a 50Ω single-ended IF. Using a TC1-1-13M+ balun, for example, the IF port is broadband matched from 4.5MHz to 3GHz, when the LO is applied.

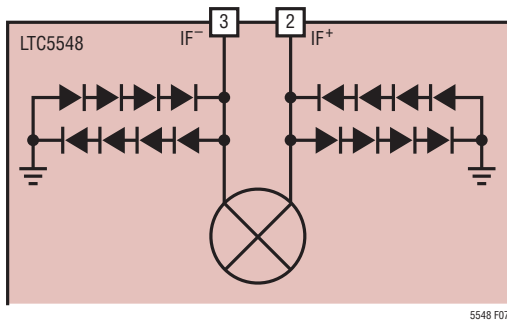

Figure 7. Simplified IF Port Schematic

The measured IF port return loss is shown in Figure 8.

The differential IF output of the LTC5548 is suitable for directly driving a wideband differential amplifier or filter. Figure 9 shows a schematic for the evaluation of LTC5548 with a differential IF at very low IF frequency.

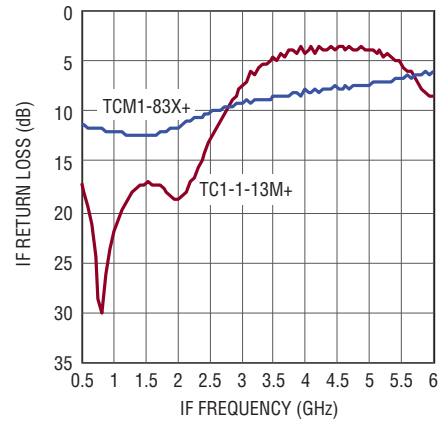

Figure 8. IF Port Return Loss

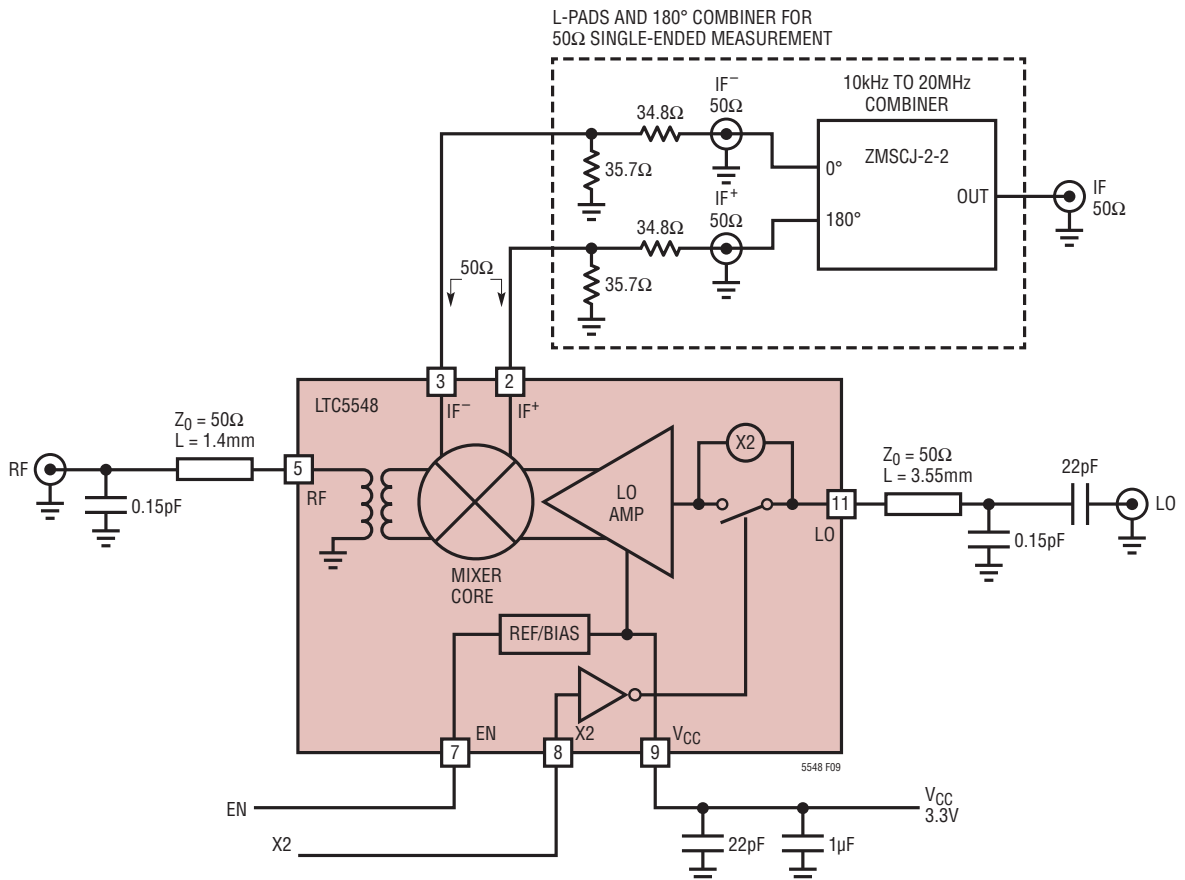

Figure 9. Test Circuit for Wideband Differential Output at IF Frequency of 10kHz to 20MHz

APPLICATIONS INFORMATION

The complete test circuit, shown in Figure 9, uses resistive impedance matching attenuators (L-pads) on an evaluation board to transform each 25Ω IF output to 50Ω. An external 0°/180° power combiner is then used to convert the 100Ω differential output to 50Ω single-ended to facilitate measurement. The measured performance is shown in Figure 10. The measured results do not include the loss of the L-pads and external 180° combiner.

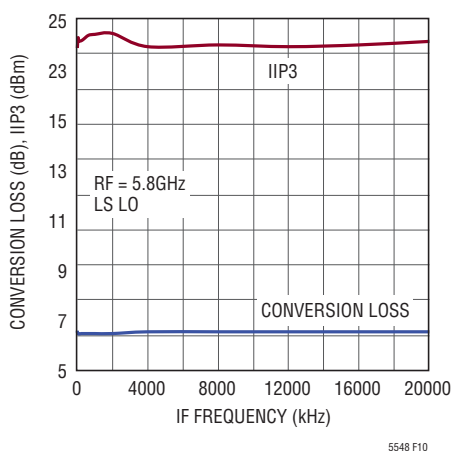

Figure 10. Conversion Gain and IIP3 for Differential IF Frequency of 10kHz to 20MHz

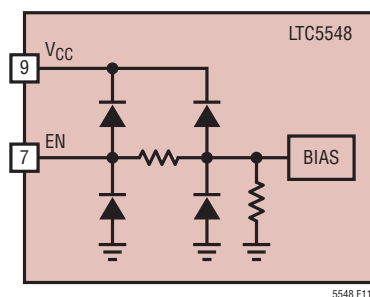

Figure 11. Simplified Enable Input Circuit

Enable Interface

Figure 11 shows a simplified schematic of the EN pin interface. To enable the chip, the EN voltage must be higher than 1.2V. The voltage at the EN pin should never exceed V_{CC} by more than 0.3V. If this should occur, the supply current could be sourced through the ESD diode, potentially damaging the IC. If the EN pin is left floating, its voltage will be pulled low by the internal pull-down resistor and the chip will be disabled.

X2 Interface

Figure 12 shows a simplified schematic of the X2 pin interface. To enable the integrated LO frequency doubler, the X2 voltage must be higher than 1.2V. The X2 voltage at the pin should never exceed V_{CC} by more than 0.3V. If this should occur, the supply current could be sourced through the ESD diode, potentially damaging the IC. If the X2 pin is left floating, its voltage will be pulled low by the internal pull-down resistor and the LO frequency doubler will be disabled.

Supply Voltage Ramping

Fast ramping of the supply voltage can cause a current glitch in the internal ESD protection circuits. Depending on the supply inductance, this could result in a supply voltage transient that exceeds the maximum rating. A supply voltage ramp time of greater than 1ms is recommended.

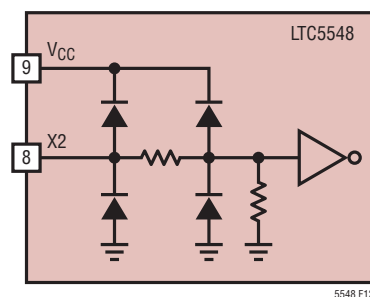

Figure 12. Simplified X2 Interface Circuit

APPLICATIONS INFORMATION

Spurious Output Levels

Mixer spurious output levels versus harmonics of the RF and LO are tabulated in Table 3. The spur levels were measured on a standard evaluation board using the test circuit shown in Figure 1. The spur frequencies can be calculated using the following equation:

$$\text{Frequency Downconversion: } f_{\text{SPUR}} = (M \cdot f_{\text{RF}}) \pm (N \cdot f_{\text{LO}})$$

$$\text{Frequency Upconversion: } f_{\text{SPUR}} = (M \cdot f_{\text{IF}}) \pm (N \cdot f_{\text{LO}})$$

Table 3a. Downconversion IF Output Spur Levels (dBc): LO Frequency Doubler Off (X2 = Low): $f_{\text{SPUR}} = (M \cdot f_{\text{RF}}) - (N \cdot f_{\text{LO}})$

RF = 5250MHz, P_{RF} = -6dBm, P_{LO} = 0dBm, LO = 4900MHz

		N					
		0	1	2	3	4	5
M	0		-25	-5	-37	-45	*
	1	-51	0	-42	-16	-59	-56
	2	-72	-69	-81	-77	-71	-75
	3	-75	-72	-78	-61	-79	-69
	4	*	-75	-77	-79	-81	-78
	5	*	*	-74	-78	-77	-81

*Out of the test equipment range.

Table 3b. Downconversion IF Output Spur Levels (dBc): LO Frequency Doubler On (X2 = High): $f_{\text{SPUR}} = (M \cdot f_{\text{RF}}) - (N \cdot f_{\text{LO}})$

RF = 5252MHz, P_{RF} = -6dBm, P_{LO} = 0dBm, LO = 2450MHz

		N								
		0	1	2	3	4	5	6	7	8
M	0		-24	-14	-8	-5	-22	-32	-32	-51
	1	-25	-18	0	-18	-29	-28	-18	-29	-43
	2	-67	-77	-64	-61	-60	-61	-68	-70	-65
	3	-75	-74	-72	-78	-72	-76	-63	-69	-78
	4	*	-76	-74	-74	-74	-76	-67	-77	-68
	5	*	*	*	-75	-75	-74	-69	-66	-70

*Out of the test equipment range.

PACKAGE DESCRIPTION

Please refer to <http://www.linear.com/product/LTC5548#packaging> for the most recent package drawings.

**UDB Package
Variation A
12-Lead Plastic QFN (3mm × 2mm)**
(Reference LTC DWG # 05-08-1985 Rev 0)

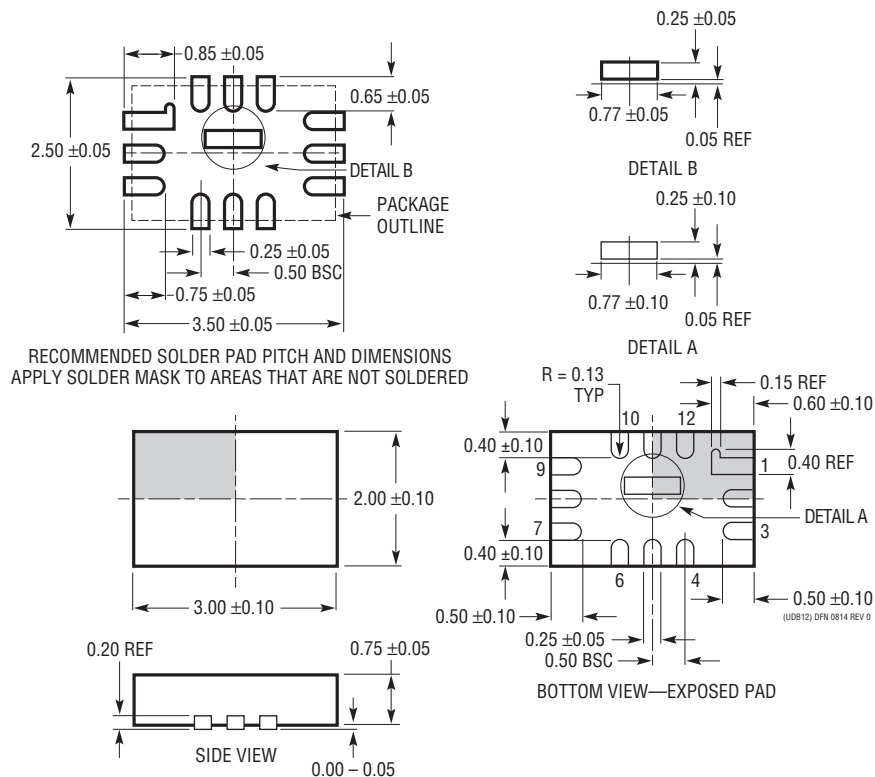

TYPICAL APPLICATION

Wideband 10MHz to 6GHz Upconversion to 6.5GHz

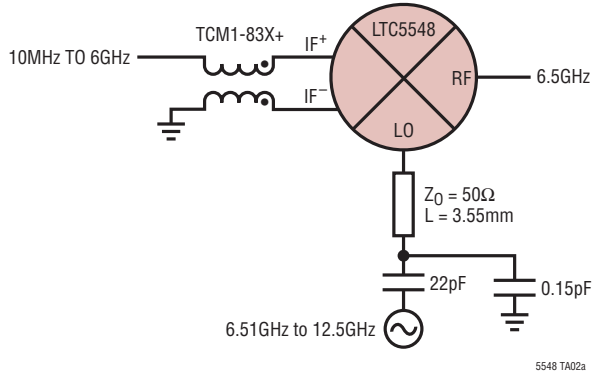

Conversion Loss and IIP3 vs Input Frequency (High Side LO)

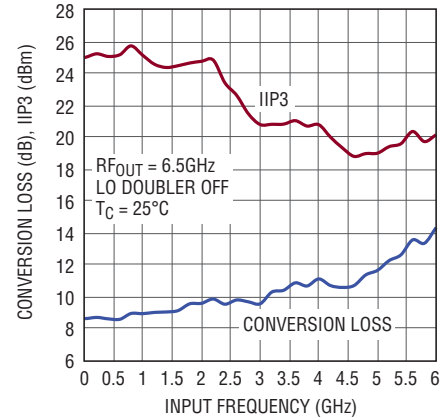

RELATED PARTS

PART NUMBER	DESCRIPTION	COMMENTS
Mixers, Modulators and Demodulators		
LTC5549	2GHz to 14GHz Microwave Mixer	8dB Conversion Loss, 24dBm IIP3, 500MHz to 6GHz Single-Ended IF with Integrated Balun
LTC5544	4GHz to 6GHz Downconverting Mixer	7.5dB Gain, >25dBm IIP3 and 10dB NF, 3.3V/200mA Supply
LTC5576	3GHz to 8GHz High Linearity Active Upconverting Mixer	25dBm OIP3, -0.6dB Gain, 14.1dB NF, -154dBm/Hz Output Noise Floor, -28dBm LO Leakage at 8GHz
LTC5551	300MHz to 3.5GHz Ultrahigh Dynamic Range Downconverting Mixer	+36dBm IIP3; 2.4dB Gain, <10dB NF, 0dBm LO Drive, +18dBm P1dB, 670mW Power Consumption
LTC5567	400MHz to 4GHz, Active Downconverting Mixer	1.9dB Gain, 26.9dBm IIP3 and 11.8dB NF at 1950MHz, 3.3V/89mA Supply
LTC5577	300MHz to 6GHz High Signal Level Active Downconverting Mixer	50Ω Matched Input from 1.3GHz to 4.3GHz, 30dBm IIP3, 0dB Gain, >40dB LO-RF Isolation, 0dBm LO Drive
LTC5510	1MHz to 6GHz Wideband High Linearity Active Mixer	50Ω Matched Input from 30MHz to 6GHz, 27dBm OIP3, 1.5dB Gain, Up- or Down-Conversion
LTC5585	4GHz Wideband I/Q Demodulator	400MHz to 4GHz Direct Conversion, 25.7dBm IIP3; 60dBm, IIP2 Adjustable to >85dBm, DC Offset Cancellation, >500MHz I & Q Bandwidth
LTC5588-1	6GHz I/Q Modulator	200MHz to 6GHz Direct Conversion, 31dBm OIP3 Adjustable to 34dBm, -160dBm/Hz Output Noise Floor, Excellent ACPR
Amplifiers		
LTC6430-20	High Linearity Differential IF Amp	20MHz to 2GHz Bandwidth, 20.8dB Gain, 51dBm OIP3, 2.9dB NF at 240MHz
LTC6431-20	High Linearity Single-Ended IF Amp	20MHz to 1.4GHz Bandwidth, 20.8dB Gain, 46.2dBm OIP3, 2.6dB NF at 240MHz
RF Power Detectors		
LTC5564	15GHz Ultra Fast 7ns Response Time RF Detector with Comparator	600MHz to 15GHz, -24dB to 16dBm Input Power Range, 9ns Comparator Response Time, 125°C Version
LT5581	6GHz Low Power RMS Detector	40dB Dynamic Range, ±1dB Accuracy Over Temperature, 1.5mA Supply Current
LTC5582	40MHz to 10GHz RMS Detector	±0.5dB Accuracy Over Temperature, ±0.2dB Linearity Error, 57dB Dynamic Range
LTC5583	Dual 6GHz RMS Power Detector	Up to 60dB Dynamic Range, ±0.5dB Accuracy Over Temperature, >50dB Isolation
RF PLL/Synthesizer with VCO		
LTC6948	Ultralow Noise, Low Spurious Frac-N PLL with Integrated VCO	373MHz to 6.39GHz, -157dBc/Hz WB Phase Noise Floor, -274dBc/Hz Normalized In-Band 1/f Noise