

FEATURES

- **Low Offset Voltage: 750 μ V Maximum**
- **Low Offset Drift: 5 μ V/ $^{\circ}$ C Maximum**
- **Input Bias Current:**
1pA (Typical at 25 $^{\circ}$ C)
15pA (Typical at 85 $^{\circ}$ C)
- **Rail-to-Rail Inputs and Outputs**
- **Gain Bandwidth Product: 14MHz**
- **CMRR: 70dB Minimum**
- **PSRR: 93dB Minimum**
- **Input Noise Voltage Density: 12nV/ $\sqrt{\text{Hz}}$**
- **Supply Current: 1.1mA per Amp**
- **Shutdown Current: 2.3 μ A per Amp**
- **2.7V to 5.5V Operation Voltage**
- **Available in 8-Lead MSOP and 10-Lead DFN Packages (LTC6087), 16-Lead SSOP and DFN Packages (LTC6088)**

APPLICATIONS

- Portable Test Equipment
- Medical Equipment
- Audio
- Data Acquisition
- High Impedance Transducer Amplifier

DESCRIPTION

The LTC[®]6087/LTC6088 are dual/quad, low noise, low offset, rail-to-rail input/output, unity-gain stable CMOS operational amplifiers that feature 1pA of input bias current. A 14MHz gain bandwidth and 7.2V/ μ s slew rate, combined with low noise (10nV/ $\sqrt{\text{Hz}}$) and a low 0.75mV offset, make the LTC6087/LTC6088 useful in a variety of applications. The 1.1mA supply current and the shutdown mode are ideal for signal processing applications which demand performance with minimal power.

The LTC6087/LTC6088 has an output stage which swings within 30mV of either supply rail to maximize signal dynamic range in low supply applications. The input common mode range includes the entire supply voltage. These op amps are specified on power supply voltages of 3V and 5V from -40 $^{\circ}$ C to 125 $^{\circ}$ C.

The dual amplifier LTC6087 is available in 8-lead MSOP and 10-lead DFN packages. The quad amplifier LTC6088 is available in 16-lead SSOP and DFN packages.

LT, LT, LTC and LTM are registered trademarks of Linear Technology Corporation. All other trademarks are the property of their respective owners.

TYPICAL APPLICATION

Single Supply Shock/Vibration Sensor Amplifier

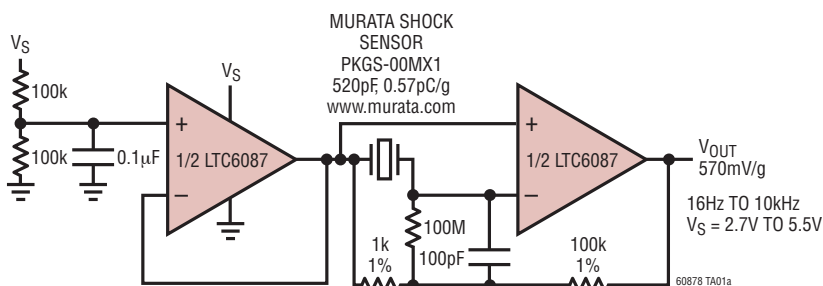

LTC6087 Input Bias Current vs Temperature

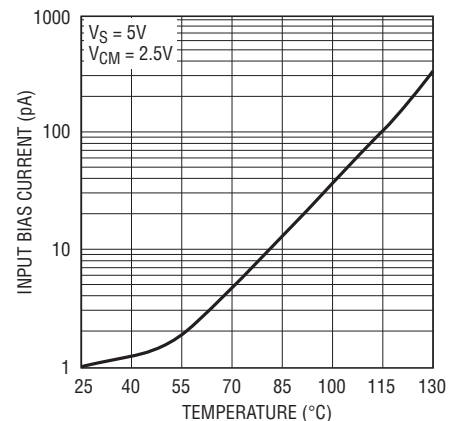

60878 TA01b
60878fa

LTC6087/LTC6088

ABSOLUTE MAXIMUM RATINGS (Note 1)

Total Supply Voltage (V^+ to V^-)	6V	Specified Temperature Range (Note 4)	
Input Voltage.....	V^- to V^+	LTC6087C/LTC6088C	0°C to 70°C
Output Short-Circuit Duration (Note 2)	Indefinite	LTC6087H/LTC6088H	-40°C to 125°C
Operating Temperature Range (Note 3)		Junction Temperature	150°C
LTC6087C/LTC6088C	-40°C to 85°C	Storage Temperature Range.....	-65°C to 150°C
LTC6087H/LTC6088H	-40°C to 125°C	Lead Temperature (Soldering, 10 sec)	
		MS8, GN16 Only	300°C

PIN CONFIGURATION

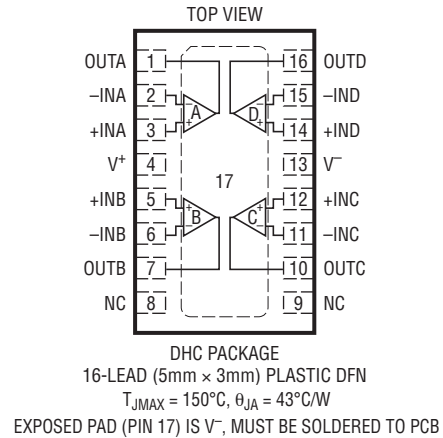
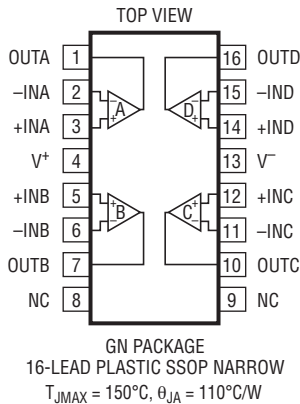
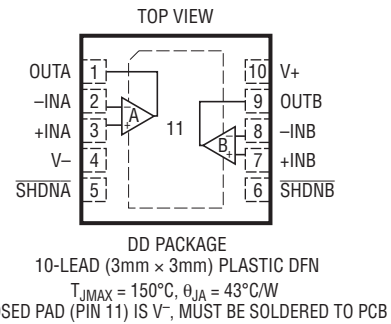
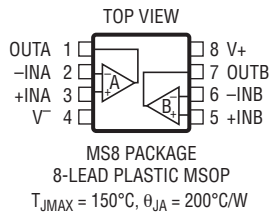

ORDER INFORMATION

LEAD FREE FINISH	TAPE AND REEL	PART MARKING*	PACKAGE DESCRIPTION	TEMPERATURE RANGE
LTC6087CDD#PBF	LTC6087CDD#TRPBF	LCTX	10-Lead (3mm × 3mm) Plastic DFN	-40°C to 85°C
LTC6087HDD#PBF	LTC6087HDD#TRPBF	LCTX	10-Lead (3mm × 3mm) Plastic DFN	-40°C to 125°C
LTC6087CMS8#PBF	LTC6087CMS8#TRPBF	LTCTY	8-Lead Plastic MSOP	-40°C to 85°C
LTC6087HMS8#PBF	LTC6087HMS8#TRPBF	LTCTY	8-Lead Plastic MSOP	-40°C to 125°C
LTC6088CDHC#PBF	LTC6088CDHC#TRPBF	6088	16-Lead (5mm × 3mm) Plastic DFN	-40°C to 85°C
LTC6088HDHC#PBF	LTC6088HDHC#TRPBF	6088	16-Lead (5mm × 3mm) Plastic DFN	-40°C to 125°C
LTC6088CGN#PBF	LTC6088CGN#TRPBF	6088	16-Lead Plastic SSOP	-40°C to 85°C
LTC6088HGN#PBF	LTC6088HGN#TRPBF	6088H	16-Lead Plastic SSOP	-40°C to 125°C

Consult LTC Marketing for parts specified with wider operating temperature ranges. *The temperature grade is identified by a label on the shipping container. Consult LTC Marketing for information on non-standard lead based finish parts.

For more information on lead free part marking, go to: <http://www.linear.com/leadfree/>

For more information on tape and reel specifications, go to: <http://www.linear.com/tapeandreeel/>

ELECTRICAL CHARACTERISTICS

The ● denotes the specifications which apply over the full specified temperature range, otherwise specifications are at $T_A = 25^\circ\text{C}$. Test conditions are $V^+ = 3\text{V}$, $V^- = 0\text{V}$, $V_{\text{CM}} = 0.5\text{V}$ unless otherwise noted.

SYMBOL	PARAMETER	CONDITIONS	C SUFFIX			H SUFFIX			UNITS
			MIN	TYP	MAX	MIN	TYP	MAX	
V_{OS}	Offset Voltage (Note 5)	LTC6087MS8, LTC6088GN		±330	±750	±330	±750	μV	
		LTC6087DD, LTC6088DHC		±330	±1100	±330	±1100	μV	
		LTC6087MS8, LTC6088GN	●		±900		±1100	μV	
		LTC6087DD, LTC6088DHC	●		±1350		±1600	μV	
$\Delta V_{\text{OS}}/\Delta T$	Input Offset Voltage Drift (Note 6)	LTC6087MS8, LTC6088GN	●	±2	±5	±2	±5	μV/°C	
		LTC6087DD, LTC6088DHC	●	±2	±5	±2	±5	μV/°C	
I_{B}	Input Bias Current (Notes 5, 7)	Guaranteed by 5V Test	●	1		1		pA	
					40		500	pA	
I_{OS}	Input Offset Current (Notes 5, 7)	Guaranteed by 5V Test	●	0.5		0.5		pA	
					30		150	pA	
e_{n}	Input Noise Voltage Density	f = 1kHz		12		12		nV/√Hz	
		f = 10kHz		10		10		nV/√Hz	
i_{n}	Input Noise Current Density (Note 8)	f = 1Hz		0.56		0.56		fA/√Hz	
				Input Common Mode Range	●	V^-	V^+	V^-	V^+
C_{IN}	Input Capacitance Differential Mode Common Mode	f = 100kHz		2.7		2.7		pF	
				4.2		4.2		pF	
CMRR	Common Mode Rejection Ratio	$0\text{V} \leq V_{\text{CM}} \leq 3\text{V}$	●	64	80	64	80	dB	
				63		61		dB	
PSRR	Power Supply Rejection Ratio	$V_{\text{S}} = 2.7\text{V to } 5.5\text{V}$	●	93	115	93	115	dB	
				90		85		dB	
V_{OUT}	Output Voltage, High (Referred to V^+)	No Load	●	5	15	5	20	mV	
		$I_{\text{SOURCE}} = 1\text{mA}$	●	25	50	25	50	mV	
		$I_{\text{SOURCE}} = 5\text{mA}$	●	120	210	120	230	mV	
	Output Voltage, Low (Referred to V^-)	No Load	●	5	25	5	30	mV	
		$I_{\text{SINK}} = 1\text{mA}$	●	25	50	25	60	mV	
		$I_{\text{SINK}} = 5\text{mA}$	●	120	210	120	240	mV	

LTC6087/LTC6088

ELECTRICAL CHARACTERISTICS The ● denotes the specifications which apply over the full specified temperature range, otherwise specifications are at $T_A = 25^\circ\text{C}$. Test conditions are $V^+ = 3\text{V}$, $V^- = 0\text{V}$, $V_{\text{CM}} = 0.5\text{V}$ unless otherwise noted.

SYMBOL	PARAMETER	CONDITIONS	C SUFFIX			H SUFFIX			UNITS	
			MIN	TYP	MAX	MIN	TYP	MAX		
A_{VOL}	Large-Signal Voltage Gain	$R_{\text{LOAD}} = 10\text{k}$, $0.5\text{V} \leq V_{\text{OUT}} \leq 2.5\text{V}$	●	500 300	3000	500 30	3000	V/mV V/mV		
I_{SC}	Output Short-Circuit Current	Source and Sink	●	25 21	35	25 18	35	mA mA		
SR	Slew Rate	$A_V = 1$		7.2		7.2		V/ μs		
GBW	Gain Bandwidth Product ($f_{\text{TEST}} = 20\text{kHz}$)	$R_{\text{LOAD}} = 50\text{k}$	●	10 9	14	10 8	14	MHz MHz		
Φ_0	Phase Margin	$R_L = 10\text{k}$, $C_L = 45\text{pF}$, $A_V = 1$		45		45		Deg		
t_S	Settling Time 0.1%	$V_{\text{STEP}} = 2\text{V}$, $A_V = -1$, $R_L = 1\text{k}$		1		1		μs		
I_S	Supply Current (per Amplifier)	No Load	●	0.85 0.80	1.05 1.05	1.20 1.25	0.85 0.75	1.05 1.35	mA mA	
	Shutdown Current (per Amplifier)	Shutdown, $V_{\text{SHDN}} \leq 0.8\text{V}$	●	0.2		1	0.2		1	μA
V_S	Supply Voltage Range	Guaranteed by the PSRR Test	●	2.7		5.5		2.7	5.5	V
	Channel Separation	$f_S = 10\text{kHz}$		-120		-120				dB
	Shutdown Logic	SHDN High	●	2		2				V
		SHDN Low	●			0.8		0.8		V
t_{ON}	Turn-On Time	$V_{\text{SHDN}} = 0.8\text{V}$ to 2V		6		6				μs
t_{OFF}	Turn-Off Time	$V_{\text{SHDN}} = 2\text{V}$ to 0.8V		2		2				μs
	Leakage of SHDN Pin	$V_{\text{SHDN}} = 0\text{V}$	●	0.1	0.5	0.1	0.5			μA

The ● denotes the specifications which apply over the full specified temperature range, otherwise specifications are at $T_A = 25^\circ\text{C}$. Test conditions are $V^+ = 5\text{V}$, $V^- = 0\text{V}$, $V_{\text{CM}} = 0.5\text{V}$ unless otherwise noted.

SYMBOL	PARAMETER	CONDITIONS	C SUFFIX			H SUFFIX			UNITS
			MIN	TYP	MAX	MIN	TYP	MAX	
V_{OS}	Offset Voltage (Note 5)	LTC6087MS8, LTC6088GN	●	± 330	± 750	± 330	± 750	μV	
		LTC6087DD, LTC6088DHC	●	± 330	± 1100	± 330	± 1100	μV	
		LTC6087MS8, LTC6088GN	●		± 900		± 1100	μV	
		LTC6087DD, LTC6088DHC	●		± 1350		± 1600	μV	
$\Delta V_{\text{OS}}/\Delta T$	Input Offset Voltage Drift (Note 6)	LTC6087MS8, LTC6088GN	●	± 2	± 5	± 2	± 5	$\mu\text{V}/^\circ\text{C}$	
		LTC6087DD, LTC6088DHC	●	± 2	± 5	± 2	± 5	$\mu\text{V}/^\circ\text{C}$	
I_B	Input Bias Current (Notes 5, 7)		●	1	40	1	500	pA nA	
			●	0.5	30	0.5	150	pA pA	
e_n	Input Noise Voltage Density	$f = 1\text{kHz}$		12		12		$\text{nV}/\sqrt{\text{Hz}}$	
		$f = 10\text{kHz}$		10		10		$\text{nV}/\sqrt{\text{Hz}}$	
	Input Noise Voltage	0.1Hz to 10Hz		2.5		2.5		$\mu\text{V}_{\text{P-P}}$	
i_n	Input Noise Current Density (Note 8)	$f = 1\text{Hz}$		0.56		0.56		$\text{fA}/\sqrt{\text{Hz}}$	
	Input Common Mode Range		●	V^-	V^+	V^-	V^+	V	
C_{IN}	Input Capacitance	$f = 100\text{kHz}$		2.7		2.7		pF	
	Differential Mode Common Mode			4.2		4.2		pF pF	

ELECTRICAL CHARACTERISTICS

The ● denotes the specifications which apply over the full specified temperature range, otherwise specifications are at $T_A = 25^\circ\text{C}$. Test conditions are $V^+ = 5\text{V}$, $V^- = 0\text{V}$, $V_{\text{CM}} = 0.5\text{V}$ unless otherwise noted.

SYMBOL	PARAMETER	CONDITIONS	C SUFFIX			H SUFFIX			UNITS	
			MIN	TYP	MAX	MIN	TYP	MAX		
CMRR	Common Mode Rejection Ratio	$0\text{V} \leq V_{\text{CM}} \leq 5\text{V}$	●	70 68	84	70 66	84	dB dB		
PSRR	Power Supply Rejection Ratio	$V_S = 2.7\text{V}$ to 5.5V	●	93 90	115	93 85	115	dB dB		
V_{OUT}	Output Voltage, High (Referred to V^+)	No Load $I_{\text{SOURCE}} = 1\text{mA}$ $I_{\text{SOURCE}} = 5\text{mA}$	● ● ●		5 20 110	15 50 190	5 20 110	20 50 210	mV mV mV	
	Output Voltage, Low (Referred to V^-)	No Load $I_{\text{SINK}} = 1\text{mA}$ $I_{\text{SINK}} = 5\text{mA}$	● ● ●		5 20 110	25 50 200	5 20 110	30 60 220	mV mV mV	
A_{VOL}	Large-Signal Voltage Gain	$R_{\text{LOAD}} = 10\text{k}$, $0.5\text{V} \leq V_{\text{OUT}} \leq 4.5\text{V}$	●	1000 500	6000	1000 50	6000	V/mV V/mV		
I_{SC}	Output Short-Circuit Current	Source and Sink	●	28 25	45	28 22	45	mA mA		
SR	Slew Rate	$A_V = 1$			7.2		7.2	V/ μs		
GBW	Gain Bandwidth Product ($f_{\text{TEST}} = 20\text{kHz}$)	$R_{\text{LOAD}} = 50\text{k}$	●	10 9	14	10 8	14	MHz MHz		
Φ_0	Phase Margin	$R_L = 10\text{k}$, $C_L = 45\text{pF}$, $A_V = 1$			47		47	Deg		
t_S	Settling Time 0.1%	$V_{\text{STEP}} = 2\text{V}$, $A_V = -1$, $R_L = 1\text{k}$			0.8		0.8	μs		
I_S	Supply Current (per Amplifier)	No Load	●	0.85 0.80	1.05 1.05	1.25 1.30	0.85 0.75	1.05 1.05	1.25 1.40	mA mA
	Shutdown Current (per Amplifier)	Shutdown, $V_{\text{SHDN}} \leq 1.2\text{V}$	●		2.3	5	2.3	5	μA	
V_S	Supply Voltage Range	Guaranteed by the PSRR Test	●	2.7		5.5	2.7		5.5	V
	Channel Separation	$f_S = 10\text{kHz}$			-120		-120			dB
	Shutdown Logic	SHDN High SHDN Low	● ●	3.5		1.2	3.5		1.2	V V
	t_{ON}	Turn-On Time			6		6			μs
t_{OFF}	Turn-Off Time	$V_{\text{SHDN}} = 3.5\text{V}$ to 1.2V			2		2			μs
	Leakage of SHDN Pin	$V_{\text{SHDN}} = 0\text{V}$	●		0.4	1	0.4	1		μA

Note 1: Stresses beyond those listed under Absolute Maximum Ratings may cause permanent damage to the device. Exposure to any Absolute Maximum Rating condition for extended periods may affect device reliability and lifetime.

Note 2: A heat sink may be required to keep the junction temperature below the absolute maximum. This depends on the power supply voltage and the total output current.

Note 3: The LTC6087C/LTC6088C are guaranteed functional over the operating temperature range of -40°C to 85°C . The LTC6087H/LTC6088H are guaranteed functional over the operating temperature range of -40°C to 125°C .

Note 4: The LTC6087C/LTC6088C are guaranteed to meet specified performance from 0°C to 70°C . The LTC6087C/LTC6088C are designed, characterized and expected to meet specified performance from -40°C to 125°C but are not tested or QA sampled at these temperatures.

The LTC6087H/LTC6088H are guaranteed to meet specified performance from -40°C to 125°C .

Note 5: ESD (electrostatic discharge) sensitive device. ESD protection devices are used extensively internal to the LTC6087/LTC6088; however, high electrostatic discharge can damage or degrade the device. Use proper ESD handling precautions.

Note 6: This parameter is not 100% tested.

Note 7: This specification is limited by high speed automated test capability. See Typical Performance Characteristic curves for actual performance.

Note 8: Current noise is calculated from:

$$i_n = \sqrt{2qI_B}$$

where $q = 1.6 \cdot 10^{-19}$ coulombs.

LTC6087/LTC6088

TYPICAL PERFORMANCE CHARACTERISTICS

V_{OS} Distribution

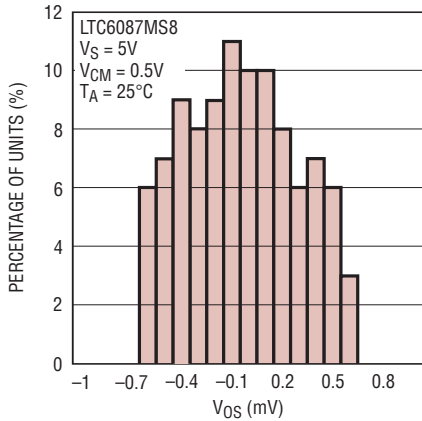

60878 G01

V_{OS} vs V_{CM}

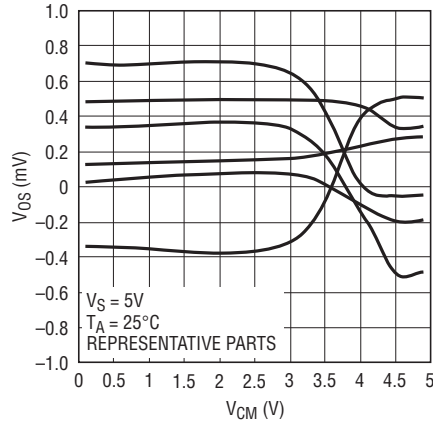

60878 G02

V_{OS} Drift Distribution

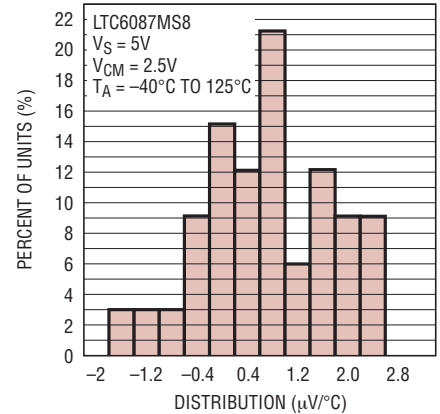

60878 G03

Input Bias Current vs Common Mode Voltage

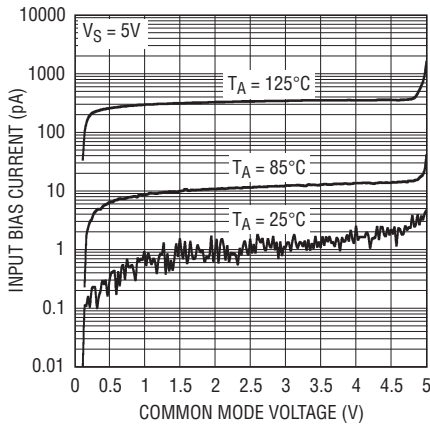

60878 G05

Input Noise Voltage vs Frequency

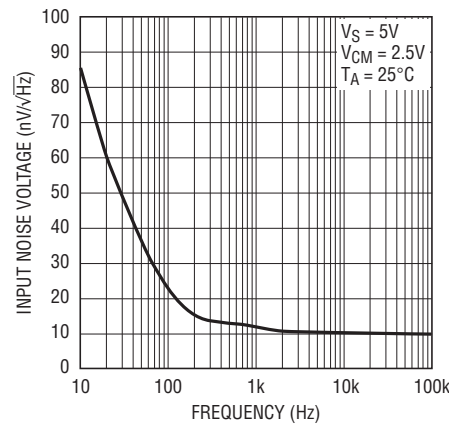

60878 G06

0.1Hz to 10Hz Output Voltage Noise

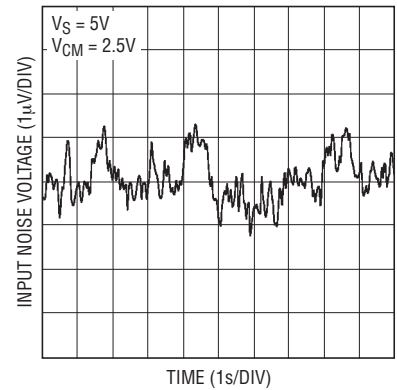

60878 G07

Input Noise Current vs Frequency

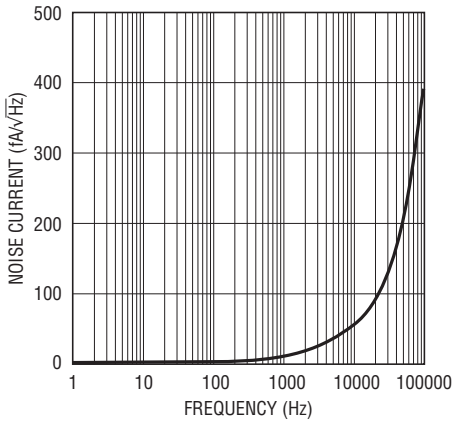

60878 G04

Output Voltage Swing vs Load Current

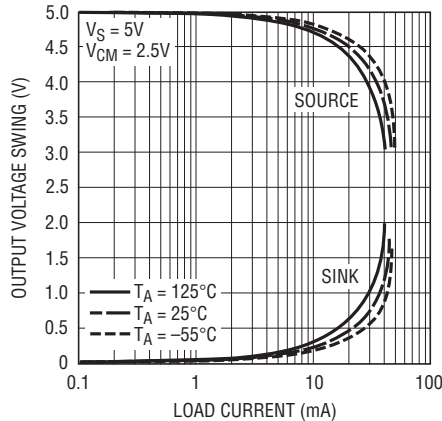

60878 G08

Supply Current vs Supply Voltage

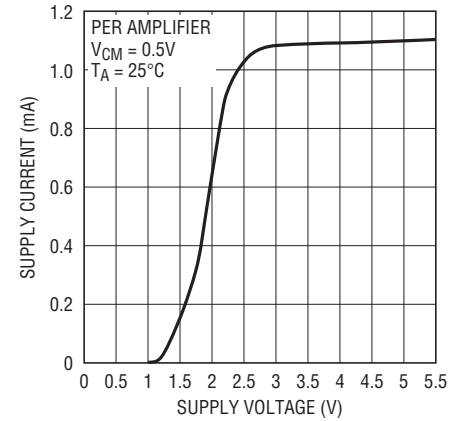

60878 G09

TYPICAL PERFORMANCE CHARACTERISTICS

Supply Current vs Temperature

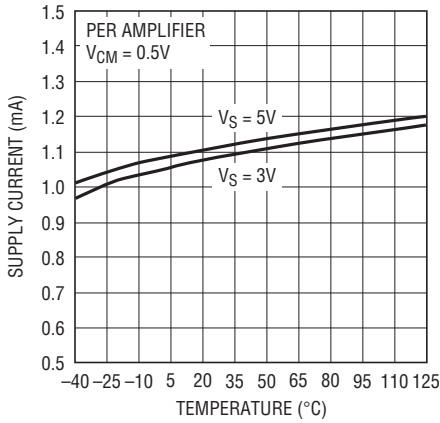

60878 G10

Open-Loop Gain vs Frequency

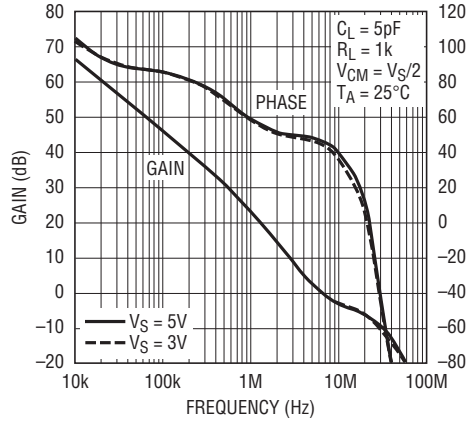

60878 G11

CMRR vs Frequency

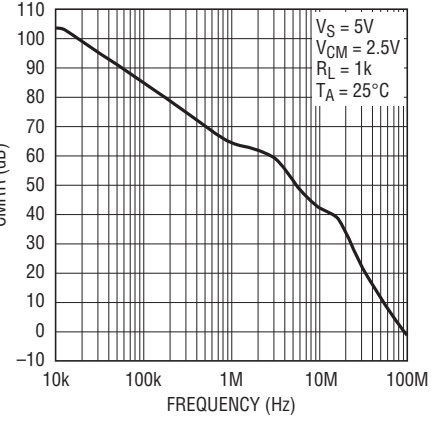

60878 G12

PSRR vs Frequency

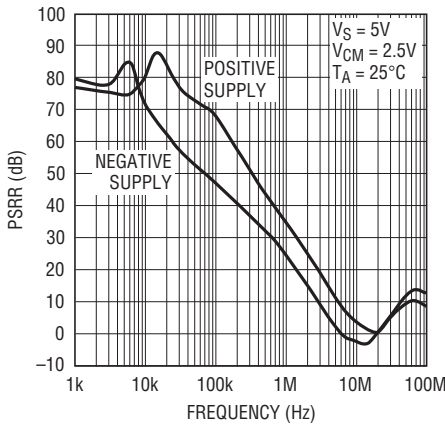

60878 G13

Output Impedance vs Frequency

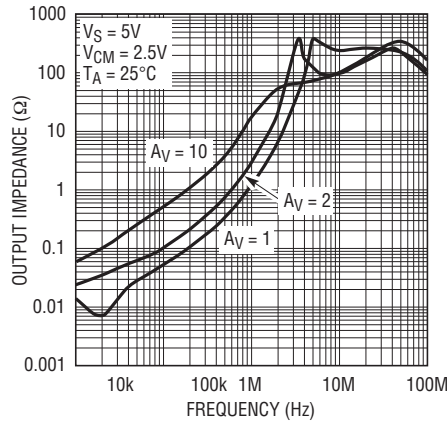

60878 G14

Small-Signal Response

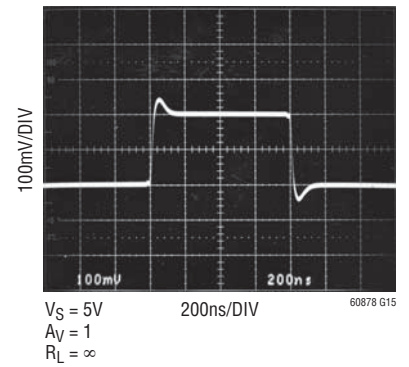

60878 G15

Small-Signal Response

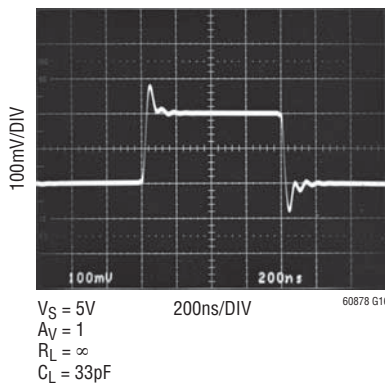

60878 G16

Large-Signal Response

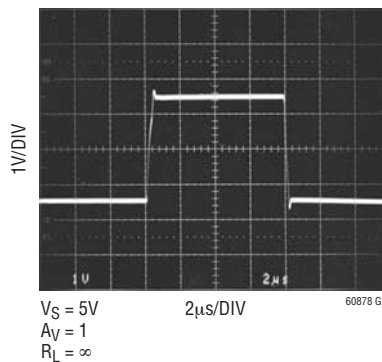

60878 G17

Large-Signal Response

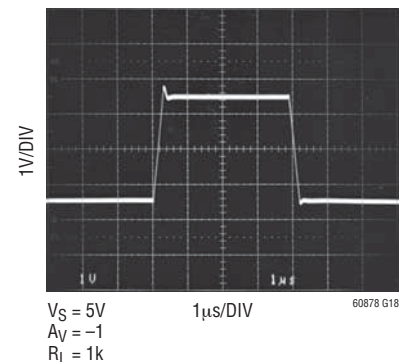

60878 G18

LTC6087/LTC6088

TYPICAL PERFORMANCE CHARACTERISTICS

Disabled Output Impedance vs Frequency

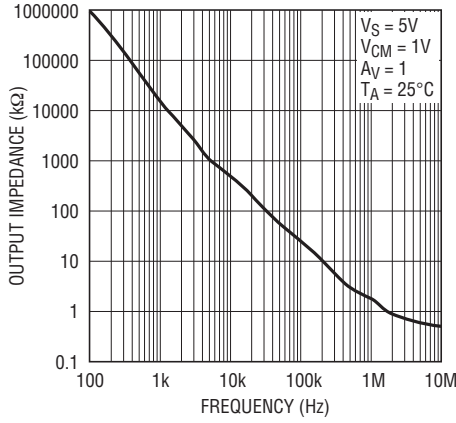

60878 G20

Overshoot vs Capacitive Load

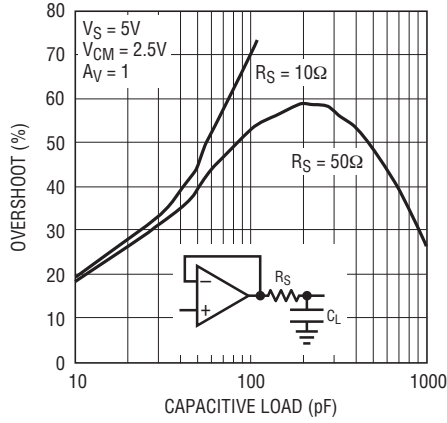

60878 G21

Overshoot vs Capacitive Load

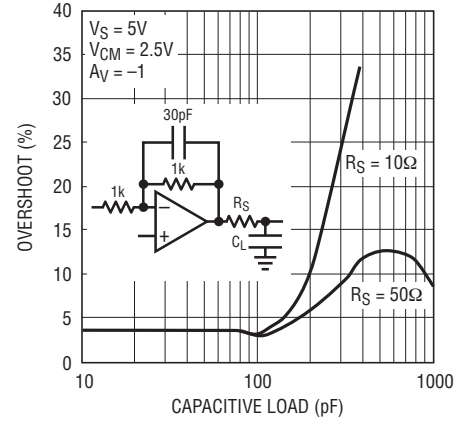

60878 G22

Channel Separation vs Frequency

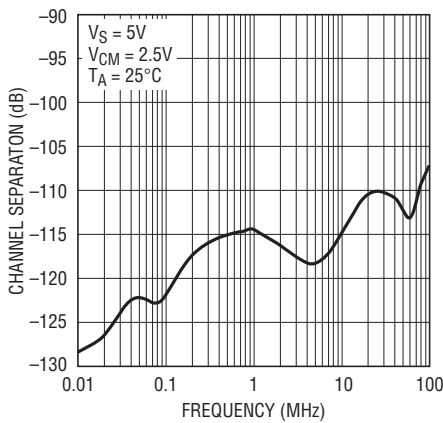

60878 G23

Total Harmonic Distortion + Noise vs Frequency

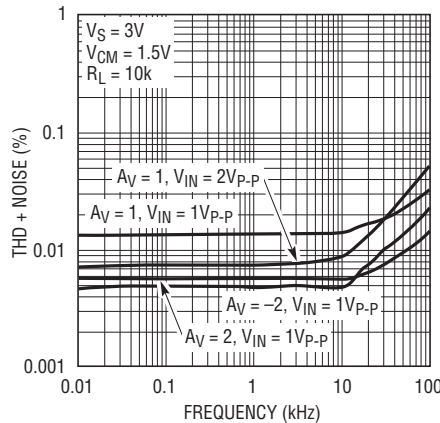

60878 G24

Total Harmonic Distortion + Noise vs Frequency

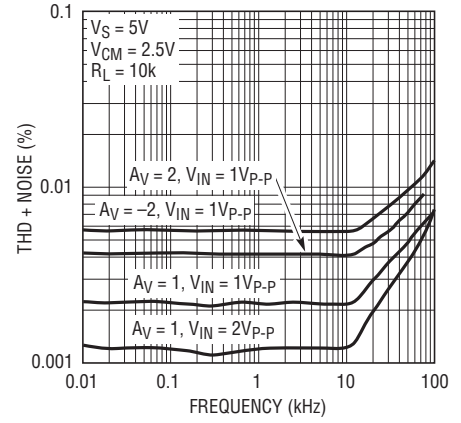

60878 G25

Total Harmonic Distortion + Noise vs Output Voltage

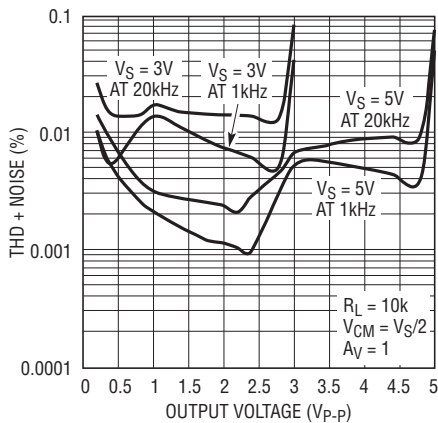

60878 G26

Total Harmonic Distortion + Noise vs Load Resistance

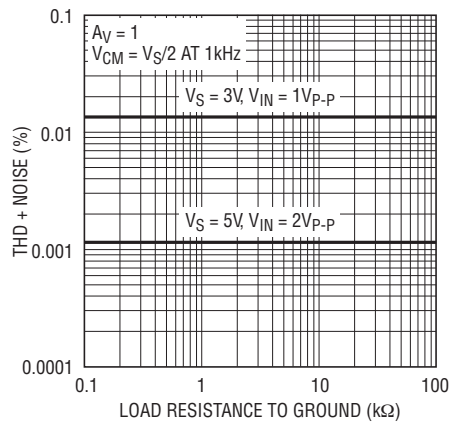

60878 G27

60878fa

PIN FUNCTIONS

OUT: Amplifier Output.

-IN: Inverting Input.

+IN: Noninverting Input.

V⁺: Positive Supply.

V⁻: Negative Supply.

SHDN A: Shutdown Pin of Amplifier A, active low and only available with the LTC 6087DD. An internal current source pulls the pin to V⁺ when floating.

SHDN B: Shutdown Pin of Amplifier B, active low and only available with the LTC 6087DD. An internal current source pulls the pin to V⁺ when floating.

NC: Not internally connected

Exposed Pad: Connected to V⁻.

APPLICATIONS INFORMATION

Rail-to-Rail Input

The input stage of LTC6087/LTC6088 combines both PMOS and NMOS differential pairs, extending its input common mode voltage to both positive and negative supply voltages. At high input common mode range, the NMOS pair is on. At low common mode range, the PMOS pair is on. The transition happens when the common voltage is between 1.3V and 0.9V below the positive supply.

Achieving Low Input Bias Current

The DD and DHC packages are leadless and make contact to the PCB beneath the package. Solder flux used during the attachment of the part to the PCB can create leakage current paths and can degrade the input bias current performance of the part. All inputs are susceptible because the backside paddle is connected to V⁻ internally. As the input voltage or V⁻ changes, a leakage path can be formed and alter the observed input bias current. For lowest bias current use the LTC6087/LTC6088 in the leaded MSOP/GN

package. With fine PCB design rules, you can also provide a guard ring around the inputs.

For example, in high source impedance applications such as pH probes, photo diodes, strain gauges, et cetera, the low input bias current of these parts requires a clean board layout to minimize additional leakage current into a high impedance signal node. A mere 100GΩ of PC board resistance between a 5V supply trace and input trace near ground potential adds 50pA of leakage current. This leakage is far greater than the bias current of the operational amplifier. A guard ring around the high impedance input traces driven by a low impedance source equal to the input voltage prevents such leakage problems. The guard ring should extend as far as necessary to shield the high impedance signal from any and all leakage paths. Figure 1 shows the use of a guard ring in a unity-gain configuration. In this case the guard ring is connected to the output and is shielding the high impedance noninverting input from V⁻. Figure 2 shows the inverting gain configuration.

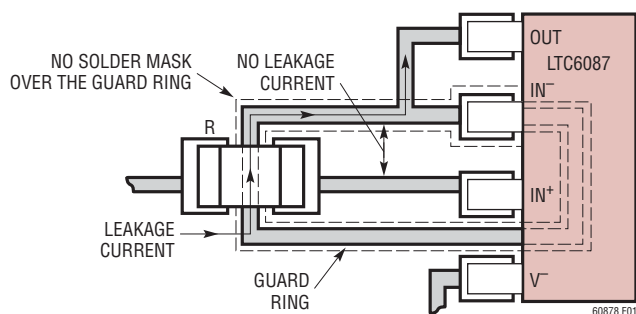

Figure 1. Sample Layout. Unity-Gain Configuration. Using Guard Ring to Shield High Impedance Input from Board Leakage

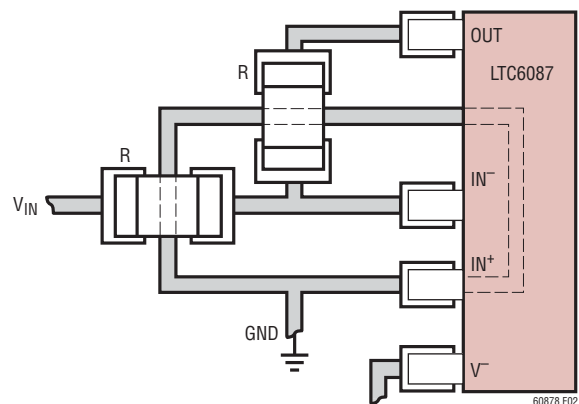

Figure 2. Sample Layout. Inverting Gain Configuration. Using Guard Ring to Shield High Impedance Input from Board Leakage

60878fa

LTC6087/LTC6088

APPLICATIONS INFORMATION

Rail-to-Rail Output

The output stage of the LTC6087/LTC6088 swings within 30mV of the supply rails when driving high impedance loads, in other words when no DC load current is present. See the Typical Performance Characteristics for curves of output swing versus load current. The class AB design of the output stage enables the op amp to supply load currents which are much greater than the quiescent supply current. For example, the room temperature short circuit current is typically 45mA.

Capacitive Load

LTC6087/LTC6088 can drive capacitive load up to 100pF in unity gain. The capacitive load driving capability increases as the amplifier is used in higher gain configurations. A small series resistance between the output and the load further increases the amount of capacitance the amplifier can drive.

SHDN Pins

Pins 5 and 6 are used for power shutdown when the LTC6087 is in the DD package. If they are floating, internal current sources pull Pins 5 and 6 to V^+ and the amplifiers operate normally. In shutdown the amplifier output is high impedance and each amplifier draws less than 5 μ A current. This feature allows the part to be used in muxed output applications as shown in Figure 3.

ESD

The LTC6087/LTC6088 has reverse-biased ESD protection diodes on all inputs and outputs as shown in the Simplified Schematic. If these pins are forced beyond either supply, unlimited current will flow through these diodes. If the current is transient and limited to one hundred milliamps or less, no damage to the device will occur.

The amplifier input bias current is the leakage current of these ESD diodes. This leakage is a function of the temperature and common mode voltage of the amplifier, as shown in the Typical Performance Characteristics.

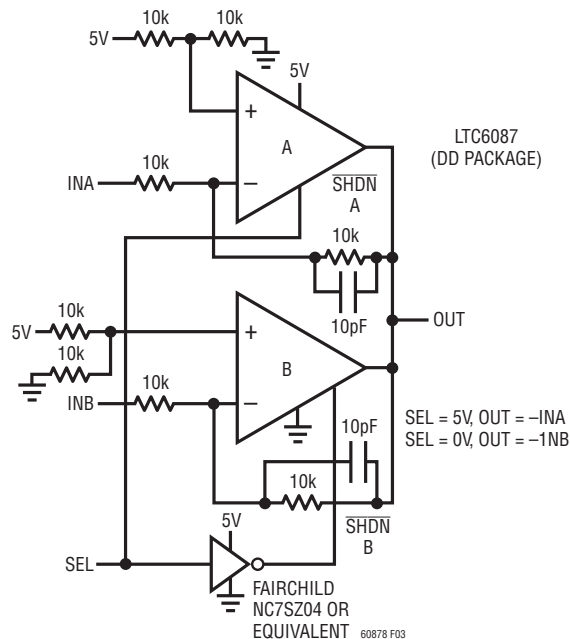

Figure 3. Inverting Amplifier with Muxed Output

Noise

In the frequency region above 1kHz, the LTC6087/LTC6088 shows good noise voltage performance. In this region, noise can be dominated by the total source resistance of the particular application. Specifically, these amplifiers exhibit the noise of a 10k resistor, meaning it is desirable to keep the source and feedback resistance at or below this value, i.e., $R_S + R_G || R_{FB} \leq 10k$. Above this total source impedance, the noise voltage is dominated by the resistor.

At low frequency, noise current can be estimated from the expression $i_n = \sqrt{2qI_B}$, where $q = 1.6 \cdot 10^{-19}$ coulombs. Equating $\sqrt{4kTR\Delta f}$ and $R\sqrt{2qI_B\Delta f}$ shows that for source resistor below 50G Ω the amplifier noise is dominated by the source resistance. Noise current rises with frequency. See the curve Noise Current vs Frequency in the Typical Performance Characteristics section.

SIMPLIFIED SCHEMATIC

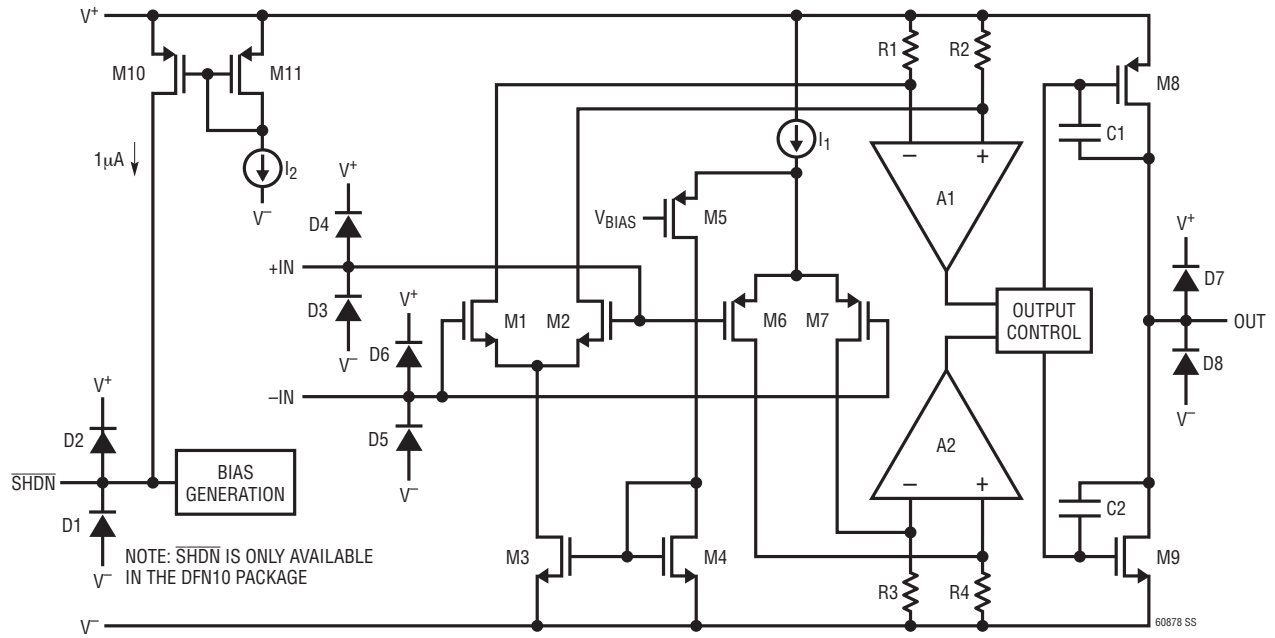

LTC6087/LTC6088

PACKAGE DESCRIPTION

MS8 Package
8-Lead Plastic MSOP

(Reference LTC DWG # 05-08-1660 Rev F)

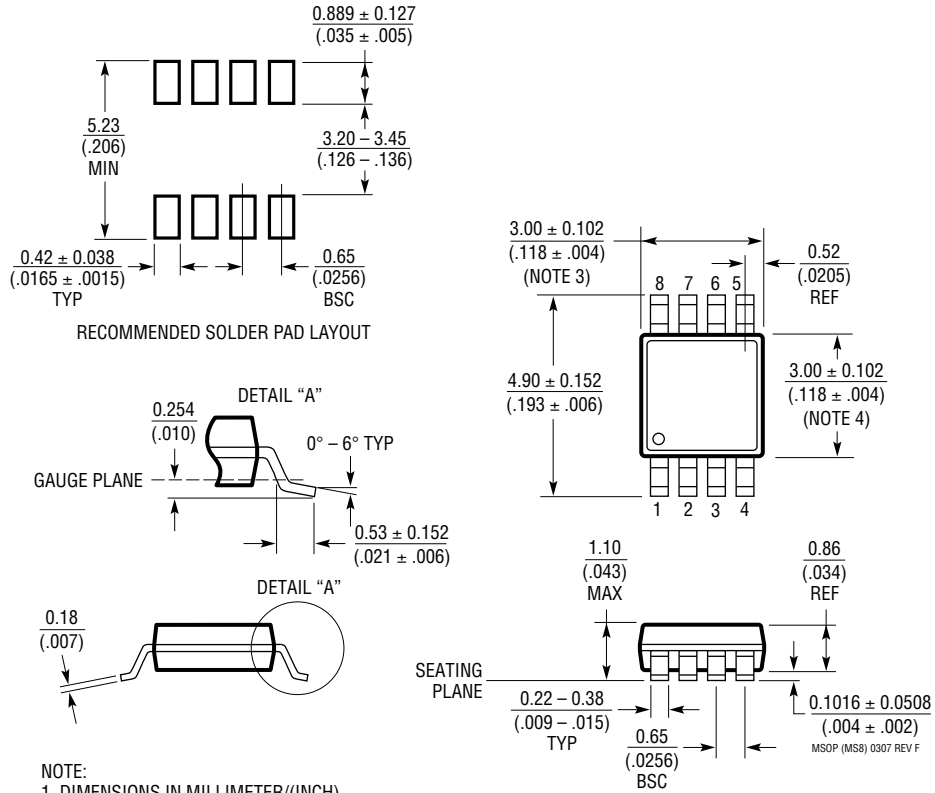

NOTE:

1. DIMENSIONS IN MILLIMETER/(INCH)
2. DRAWING NOT TO SCALE
3. DIMENSION DOES NOT INCLUDE MOLD FLASH, PROTRUSIONS OR GATE BURRS.
MOLD FLASH, PROTRUSIONS OR GATE BURRS SHALL NOT EXCEED 0.152mm (.006") PER SIDE
4. DIMENSION DOES NOT INCLUDE INTERLEAD FLASH OR PROTRUSIONS.
INTERLEAD FLASH OR PROTRUSIONS SHALL NOT EXCEED 0.152mm (.006") PER SIDE
5. LEAD COPLANARITY (BOTTOM OF LEADS AFTER FORMING) SHALL BE 0.102mm (.004") MAX

PACKAGE DESCRIPTION

DD Package 10-Lead Plastic DFN (3mm × 3mm) (Reference LTC DWG # 05-08-1699)

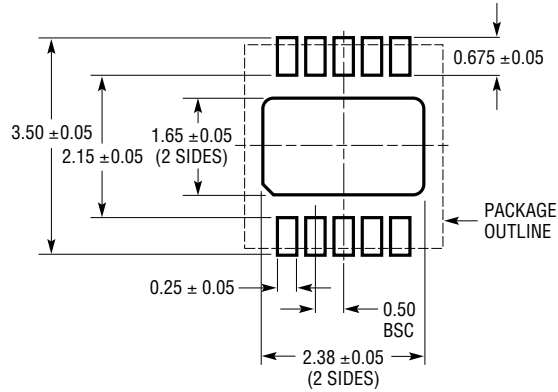

RECOMMENDED SOLDER PAD PITCH AND DIMENSIONS

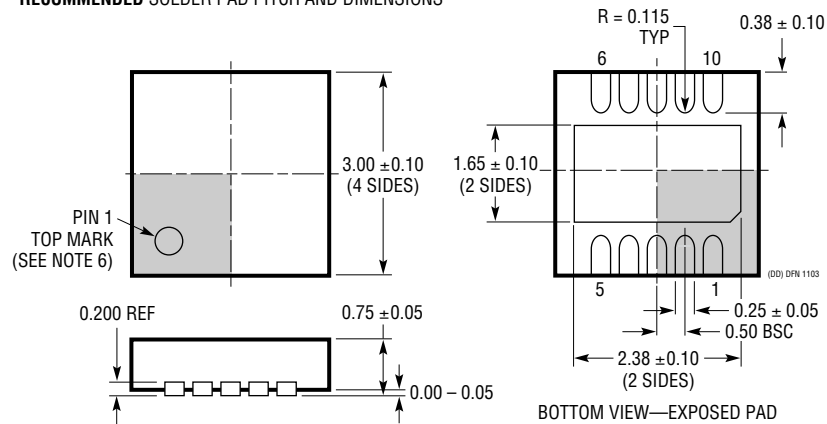

NOTE:

- DRAWING TO BE MADE A JEDEC PACKAGE OUTLINE M0-229 VARIATION OF (WEED-2). CHECK THE LTC WEBSITE DATA SHEET FOR CURRENT STATUS OF VARIATION ASSIGNMENT
- DRAWING NOT TO SCALE
- ALL DIMENSIONS ARE IN MILLIMETERS
- DIMENSIONS OF EXPOSED PAD ON BOTTOM OF PACKAGE DO NOT INCLUDE MOLD FLASH. MOLD FLASH, IF PRESENT, SHALL NOT EXCEED 0.15mm ON ANY SIDE
- EXPOSED PAD SHALL BE SOLDER PLATED
- SHADED AREA IS ONLY A REFERENCE FOR PIN 1 LOCATION ON THE TOP AND BOTTOM OF PACKAGE

LTC6087/LTC6088

PACKAGE DESCRIPTION

GN Package 16-Lead Plastic SSOP (Narrow .150 Inch) (Reference LTC DWG # 05-08-1641)

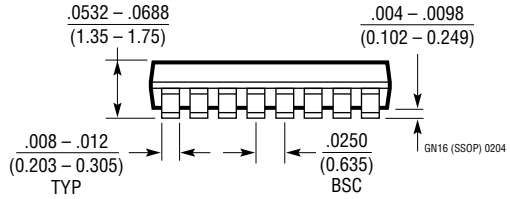
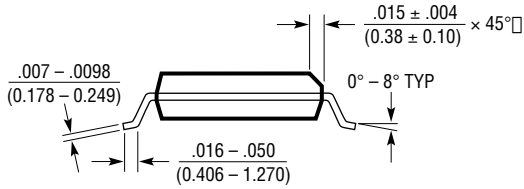
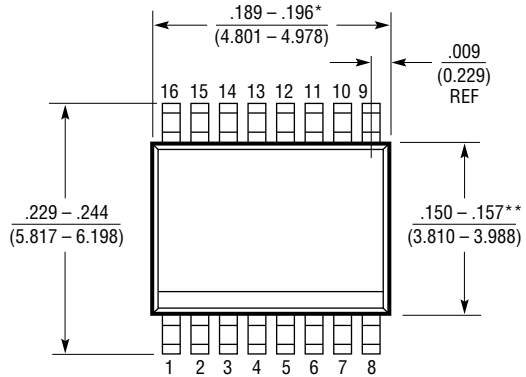
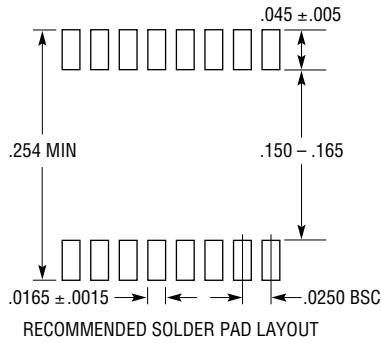

- NOTE:
1. CONTROLLING DIMENSION: INCHES
 2. DIMENSIONS ARE IN $\frac{\text{INCHES}}{\text{MILLIMETERS}}$
 3. DRAWING NOT TO SCALE
- *DIMENSION DOES NOT INCLUDE MOLD FLASH. MOLD FLASH SHALL NOT EXCEED 0.006" (0.152mm) PER SIDE
- **DIMENSION DOES NOT INCLUDE INTERLEAD FLASH. INTERLEAD FLASH SHALL NOT EXCEED 0.010" (0.254mm) PER SIDE

PACKAGE DESCRIPTION

DHC Package 16-Lead Plastic DFN (5mm × 3mm) (Reference LTC DWG # 05-08-1706)

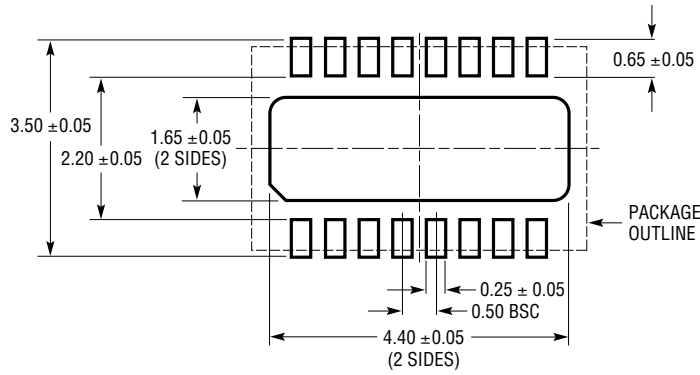

RECOMMENDED SOLDER PAD PITCH AND DIMENSIONS

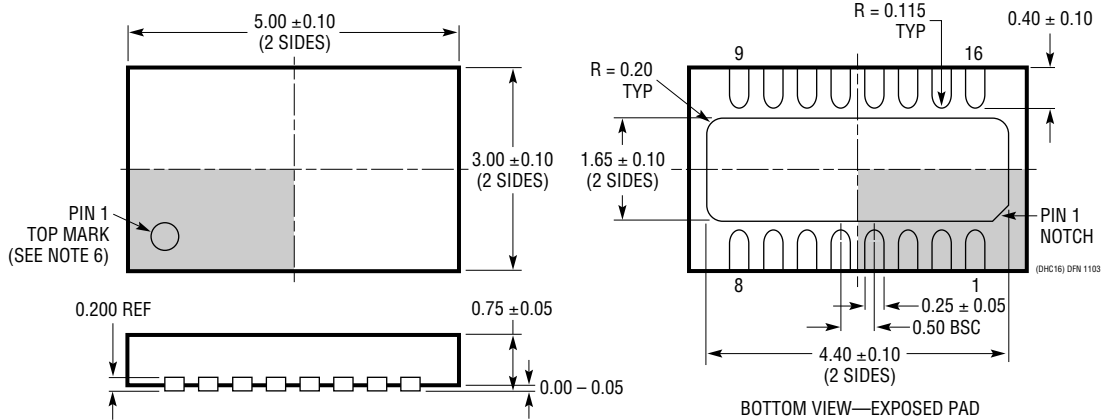

- NOTE:
1. DRAWING PROPOSED TO BE MADE VARIATION OF VERSION (WJED-1) IN JEDEC PACKAGE OUTLINE MO-229
 2. DRAWING NOT TO SCALE
 3. ALL DIMENSIONS ARE IN MILLIMETERS
 4. DIMENSIONS OF EXPOSED PAD ON BOTTOM OF PACKAGE DO NOT INCLUDE MOLD FLASH. MOLD FLASH, IF PRESENT, SHALL NOT EXCEED 0.15mm ON ANY SIDE
 5. EXPOSED PAD SHALL BE SOLDER PLATED
 6. SHADED AREA IS ONLY A REFERENCE FOR PIN 1 LOCATION ON THE TOP AND BOTTOM OF PACKAGE

LTC6087/LTC6088

TYPICAL APPLICATIONS

Negative-Going and Positive-Going Photodiode TIAs on $\pm 5V$ Supplies

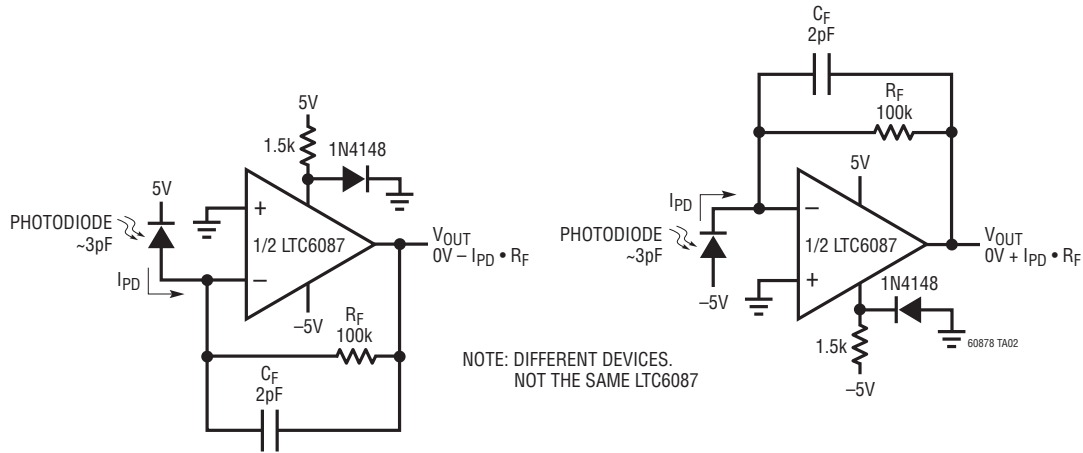

Almost Rail-to-Rail (0.3V to V_{CC}) Gain-of-30 Current Sense Amplifier

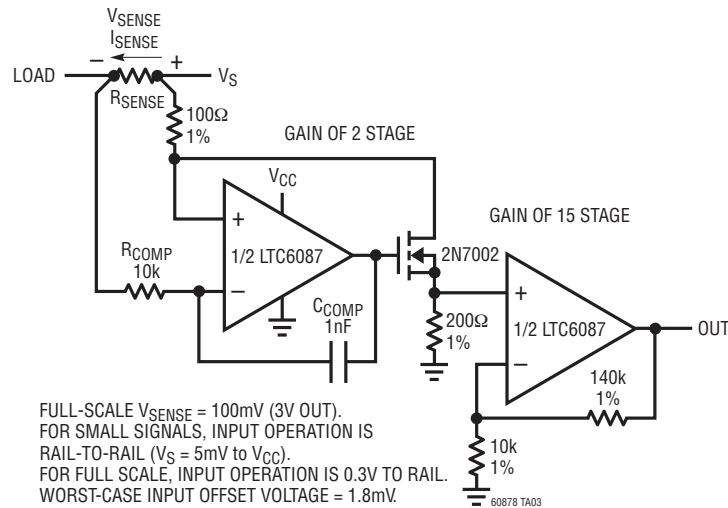

RELATED PARTS

PART NUMBER	DESCRIPTION	COMMENTS
LTC2051/LTC2052	Dual/Quad Zero-Drift Op Amps	$3\mu\text{V } V_{OS(\text{MAX})}$, $30\text{nV}/^\circ\text{C } V_{OS}$ Drift (MAX)
LTC6078/LTC6079	Dual/Quad Micropower Precision Rail-to-Rail Op Amps	$25\mu\text{V } V_{OS(\text{MAX})}$, $0.7\mu\text{V}/^\circ\text{C } V_{OS}$ Drift (MAX), $1\text{pA } I_{BIAS(\text{MAX})}$
LTC6240	Single Low Noise Rail-to-Rail Output Op Amp	$7\text{nV}/\sqrt{\text{Hz}}$ Noise, $1\text{pA } I_{BIAS(\text{MAX})}$, $10\text{V}/\mu\text{s}$ Slew Rate
LTC6241/LTC6242	Dual/Quad Low Noise Rail-to-Rail Output Op Amps	$7\text{nV}/\sqrt{\text{Hz}}$ Noise, $0.2\text{pA } I_{BIAS}$, 18MHz Gain Bandwidth
LTC6244	Dual 50MHz Rail-to-Rail Op Amps	$100\mu\text{V } V_{OS(\text{MAX})}$, $1\text{pA } I_{BIAS}$, $40\text{V}/\mu\text{s}$ Slew Rate

60878fa