



ELECTRONICS

Preliminary

Product Information

ISSUE DATE : 04-08-24

MODEL : LTC700WV-F01

Note : This product information is subject to change without notice.

PREPARED BY : Mobile Display Development Team

Samsung Electronics Co . , LTD.



Contents

- 1. Application
- 2. Features
- 3. Mechanical specifications
- 4. Absolute maximum ratings
- 5. Mechanical drawing of the module
- 6. Pin assignment
 - 6-1. Panel driving part
 - 6-2. Backlight driving part
- 7. Electrical characteristics
 - 7-1. Panel driving conditions
 - 7-2. Backlight driving conditions
 - 7-3. Input signal timing characteristics
 - 7-4. Input signal timing diagram
 - 7-5. Block diagram
- 8. Optical characteristics

1. Application

LTC700WV-F01 is a color active matrix TFT LCD that uses a-Si TFT as a switching devices. Customer can use in general equipment designs which require high quality flat panel displays.

- Car navigation system
- Automotive auxiliary information display
- Automotive audio visual equipment
- AV monitor including Pachinko, portable DVD Player, etc.

- * TFT : Thin Film Transistor
- * LCD : Liquid Crystal Display
- * a-Si : amorphous Silicon

2. Features

- a-Si active matrix TFT LCD
- TN normally white mode
- Transmissive and Landscape type.
- Back light with CCFL
- TTL Interface(6Bit*RGB digital)
- CR max direction is 6 o'clock
- Aspect Ratio is 15:9

3. Mechanical Specifications

Items	Specification	Unit	Remark
Display size	7.0	inch	Diagonal
Active area	152.4 x 91.44	mm	
Number of dots	800 x RGB x 480	dot	
Dot pitch	0.0635 x 0.1905	mm	
Pixel configuration	R,G,B vertical stripe		
Outline dimension	169.8 x 108.0 x 12.0	mm	(Note 3-1)
Weight	TBD	g	
Surface treatment	AG WV film		

(Note 3-1)

Timing control board included. Refer to 5. Mechanical drawing of the module.

4. Absolute maximum ratings

Item	Symbol	Min	Max	Unit	Remark
Input voltage	VI	-0.3	4.0	V	(Note 4-1)
Power supply	VDD	-0.3	4.0	V	
Operating temperature (Panel surface temperature)	Topr	-30	85		(Note 4-2)
Storage temperature (Ambient temperature)	Tstg	-40	85		

(Note 4-1)

CLK, R0~R5,G0~G5,B0~B5,DE,UD/RL

(Note 4-2)

The operating temperature only guarantees operation of the circuit.

In case of below 0°, the response time of liquid crystal (LC) becomes slower and the color of panel becomes darker than normal one.

Level of retardation depends on temperature, because of LC's characteristics.

If product is exposed to high temperatures for extended time, there is a possibility of the polarizer film damage which could degrade the optical characteristics.

5. Mechanical drawing of the module

Preliminary

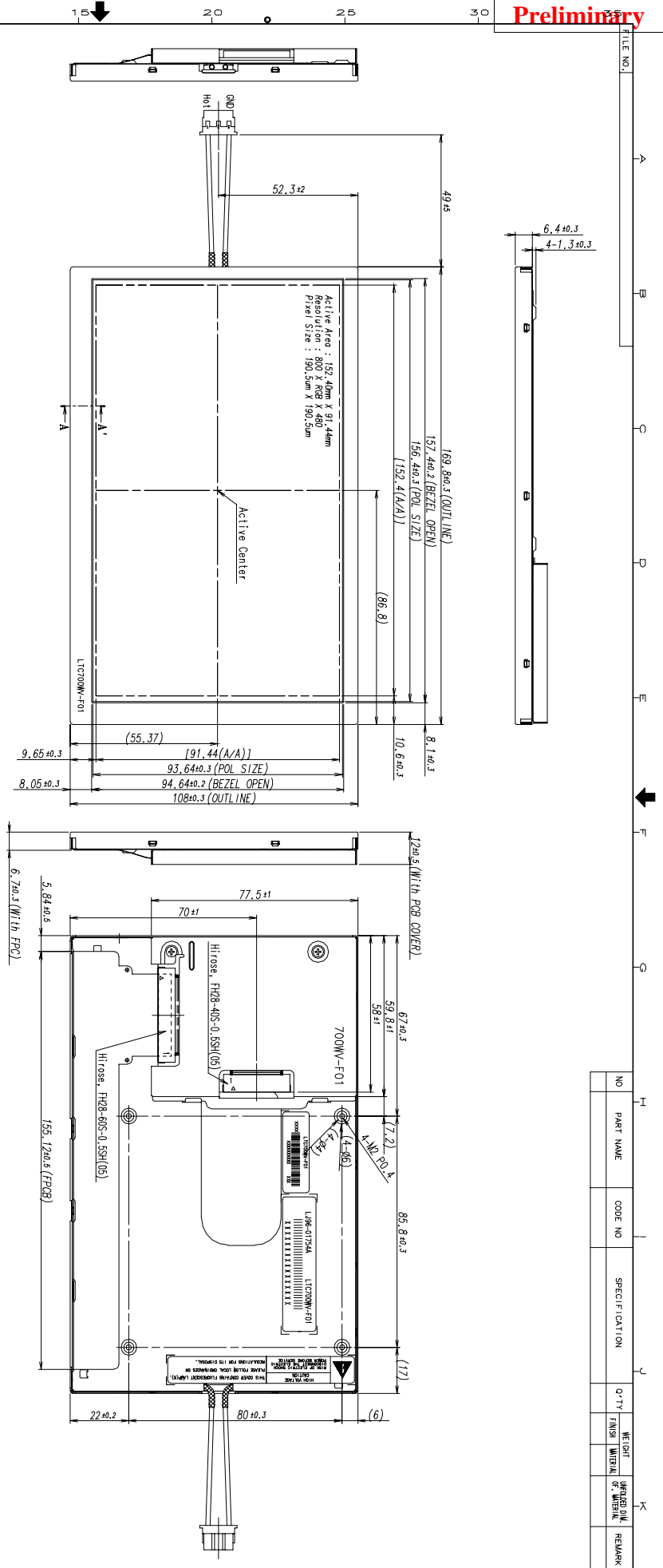

SECTION A-A' (S-5/1)

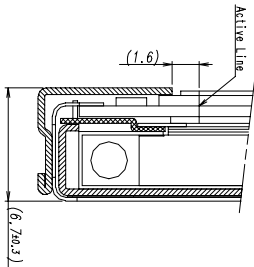

** NOTE
 1. COFT CONNECTOR FOR BACK LIGHT TO BE SPECIFIED AS BELOW.
 - MAKER : JST
 - PART NO : BHR-Q31S-1

GENERAL TOLERANCE

STEP	LEVEL 1	LEVEL 2	LEVEL 3	REV.	DATE	DESCRIPTION OF REVISION	REASON	CHK'D BY
0 < X ≤ 4	±0.05	±0.1	±0.2					
4 < X ≤ 16	±0.08	±0.15	±0.3					
16 < X ≤ 64	±0.12	±0.25	±0.5					
64 < X ≤ 256	±0.25	±0.4	±0.8					

SAMSUNG ELECTRONICS

MODEL NAME: LTC700WV-F01
 PART/SHEET NAME: OUTLINE DIMENSION
 SHEET 1/1
 VER. 000

NO	PART NAME	CODE NO	SPECIFICATION	Q-TY	WEIGHT	FINISH	REMARK

6. Pin assignment

6-1. Panel driving part - current mounted connector : JAE FA5S040HF1

It will be changed to Hirose FH28-40S-0.5SH(05).

Pin No.	Symbol	Description	Remark
1	GND	Ground	
2	CLK	Dot clock	
3	GND	Ground	
4	R0	Red data LSB	
5	R1	Red data	
6	R2	Red data	
7	GND	Ground	
8	R3	Red data	
9	R4	Red data	
10	R5	Red data MSB	
11	GND	Ground	
12	G0	Green data LSB	
13	G1	Green data	
14	G2	Green data	
15	GND	Ground	
16	G3	Green data	
17	G4	Green data	
18	G5	Green data MSB	
19	GND	Ground	
20	B0	Blue data LSB	
21	B1	Blue data	
22	B2	Blue data	
23	GND	Ground	
24	B3	Blue data	
25	B4	Blue data	
26	B5	Blue data MSB	
27	GND	Ground	
28	NC	No connection	
29	NC	No connection	
30	DE	Data Enable	
31	UD/RL	Control of the scanning direction	(Note 6-1)
32	GND	Ground	
33	NC	No connection	
34	NC	No connection	
35	GND	Ground	
36	GND	Ground	
37	VDD	+3.3V Power	
38	VDD	+3.3V Power	
39	VDD	+3.3V Power	
40	VDD	+3.3V Power	

(Note 6-1) Scanning direction

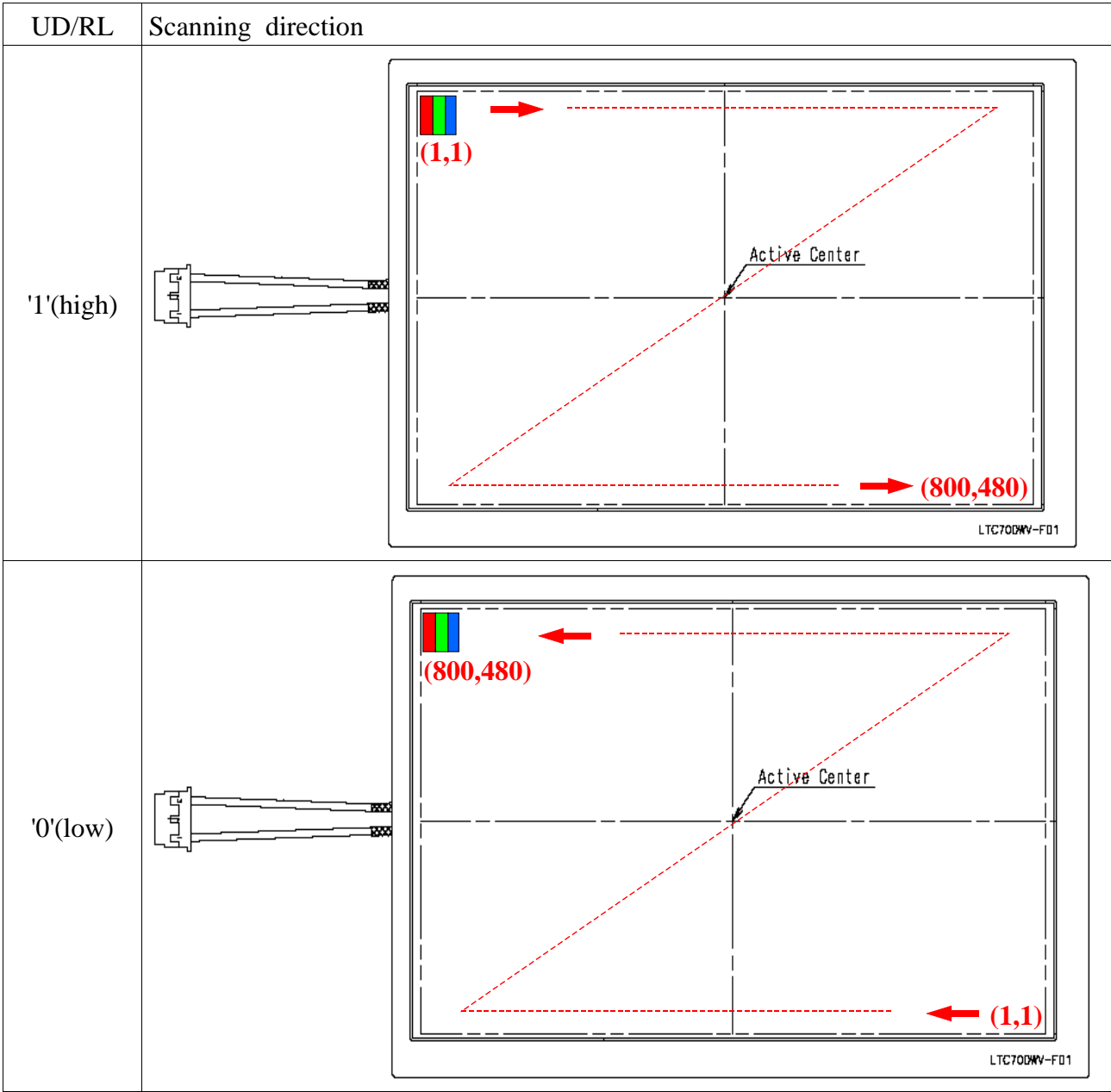

6-2. Backlight driving part - Connector(Housing) for Backlight : JST BHR-03VS-1

No.	Symbol	Description	Remark
1	Hot	Input terminal(high voltage side)	Pink
2	-	Open	-
3	GND	Input terminal(low voltage side)	White

7. Electrical characteristics

7-1. Panel driving conditions (GND=0V)

Item	Symbol	MIN	TYP	MAX	Unit	Remark
Power supply	Input voltage	VDD	(3.135)	3.3	(3.465)	V
	Current consumption	IDD		TBD		mA
Input low voltage	VIL	-	-	0.3VDD	V	
Input high voltage	VIH	0.7VDD	-	-	V	

7-2. Backlight driving conditions

Item	Symbol	MIN	TYP	MAX	Unit	Remark
Lamp current	IL	4.0	7.0	8.0	mArms	(Note 7-1)
Lamp voltage	VL	-	(510)	-	Vrms	(Note 7-2)
Power consumption	PL		(3.57)		W	
Lamp frequency	FR	40	60	(80)	KHz	(Note 7-3)
Startup voltage	VS		-	1050	Vrms	Ta = +25
			-	1320	Vrms	Ta = +0
Lamp life time	-	10,000	-		Hour	(Note 7-4)

(Note 7-1) Current range that lifetime and reliability can be guaranteed.

Lamp current is measured with high frequency current meter as shown below.

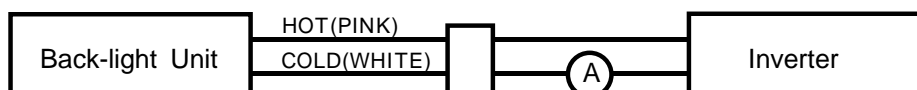

(Note 7-2) The waveform of the inverter output voltage must be area symmetric and the design of the inverter must have specifications for the modularized lamp.

(Note 7-3) Lamp frequency may produce interference with horizontal synchronous frequency and may cause line flow on the display. Therefore lamp frequency should be detached from the horizontal synchronous frequency and its harmonics as far as possible in order to avoid interference.

(Note 7-4) Lamp life time is defined as the time when the brightness of the panel not to become less than 50% of the original value in the continuous operation under the condition of lamp allowed current at the ambient temperature 25 ± 5 .

7-3. Input signal timing characteristics

Item	Symbol	MIN	TYP	MAX	Unit	Remark
Clock (CLK)	frequency	Fclk	-	31.0	-	MHz
	period	Tclk	-	32.3	-	ns
	high level width	Tcwh	12	-	-	ns
	low level width	Tcwl	12	-	-	ns
DATA (R,G,B,UD/RL)	set up time	Tdsu	5	-	-	ns
	hold time	Tdhd	10	-	-	ns
Data enable (DE)	set up time	Tdesu	5	-	-	ns
	hold time	Tdehd	10	-	-	ns
	high level width	Tdeh	-	800	-	Tclk
	low level width	Tdel	150	-	208	Tclk
Vertical blanking time	Tvb	10	-	-	Tde	

7-4. Input signal timing diagram

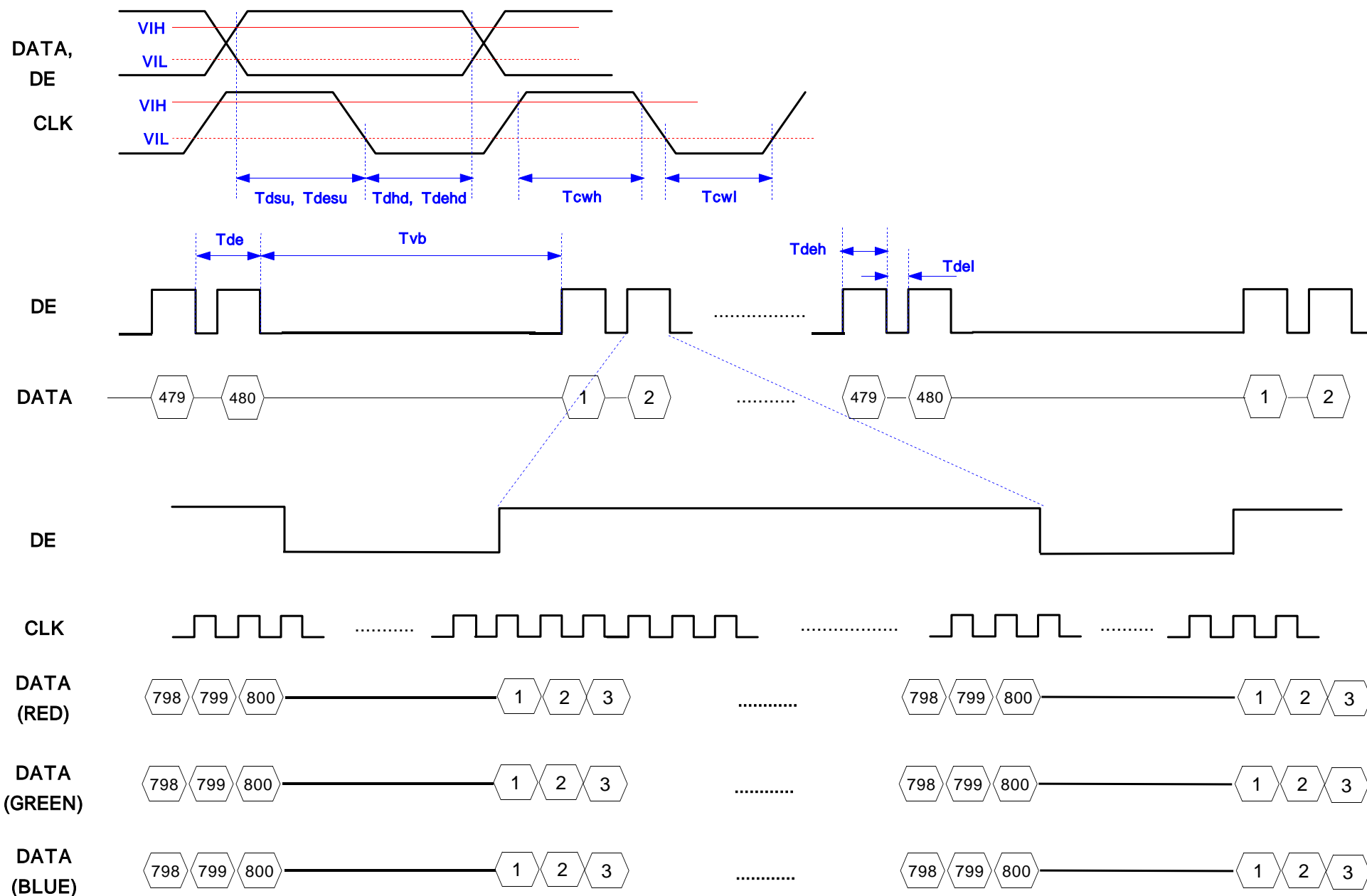

7-5. Block diagram

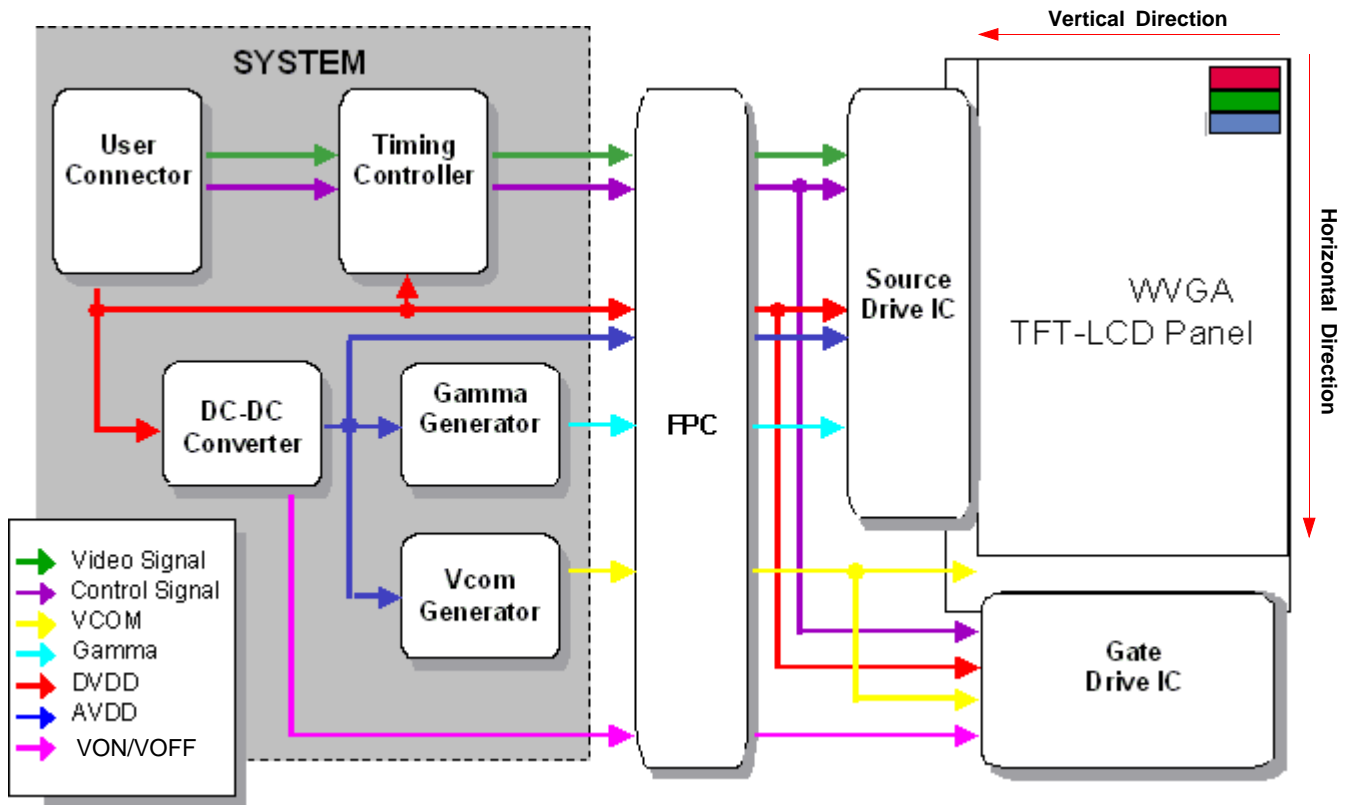

8. Optical characteristics

Item	Symbol	Condition	MIN	TYP	MAX	Unit	Remark	
Contrast Ratio	CR	=0	-	(300)	-		(Note 8-1)	
Response time at 25	Rising	=0	-	(10)	-	ms	(Note 8-2)	
	Falling		-	(20)	-			
White luminance	Y_L	Viewing Normal Angle	-	(450)	-	cd/m^2	(Note 8-3)	
White chromaticity	W_x		-	(0.305)	-	-		
	W_y	-	(0.340)	-	-			
Viewing Angle	Hor.	CR 10	-	(65)	-	Degrees	(Note 8-4)	
			R	-	(65)			-
	Ver.		H	-	(45)			-
			L	-	(55)			-

(Test Condition)

Optical characteristic is measured in a stable, windless, and dark room after 30 minutes operation. It is measured in the center of the screen.

- Environment condition : $T_a = 25 \pm 2 \text{ }^\circ\text{C}$
- Back-Light On condition (IL=7mA, Inverter = SIC 130T)
- Photodetector : BM-5A , EZ-Contrast

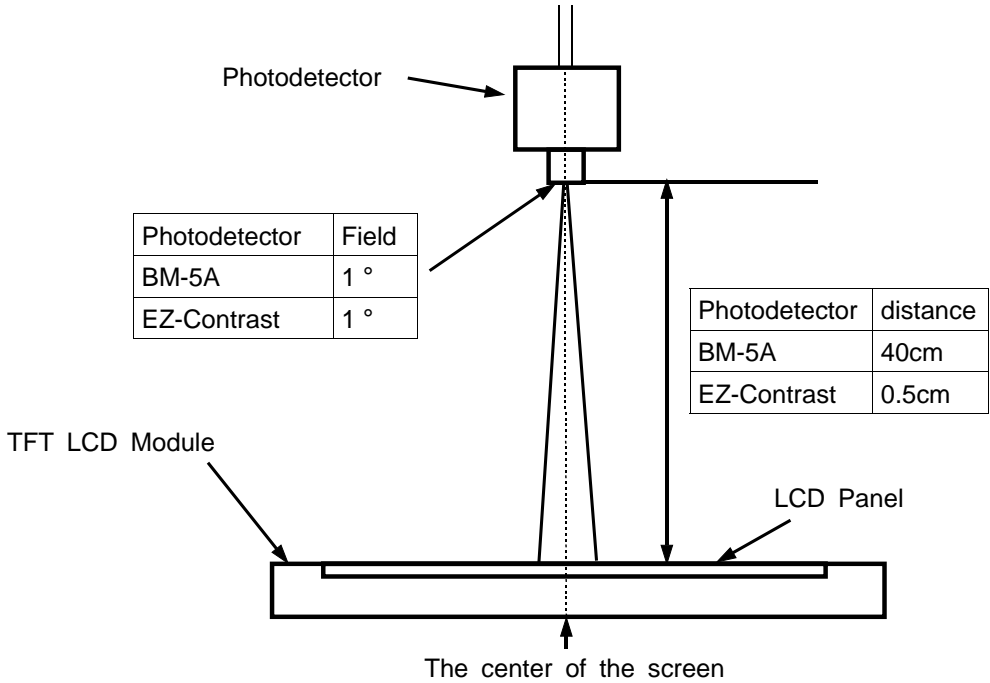

(Note 8-1) Definition of Contrast Ratio (C/R)

Ratio of gray max (Gmax) & gray min (Gmin) at the center point of the panel.

$$C/R = \frac{G_{max}}{G_{min}}$$

* Gmax : Luminance with all pixels white
* Gmin : Luminance with all pixels black

(Note 8-2) Definition of Response time : Sum of TR ,TF

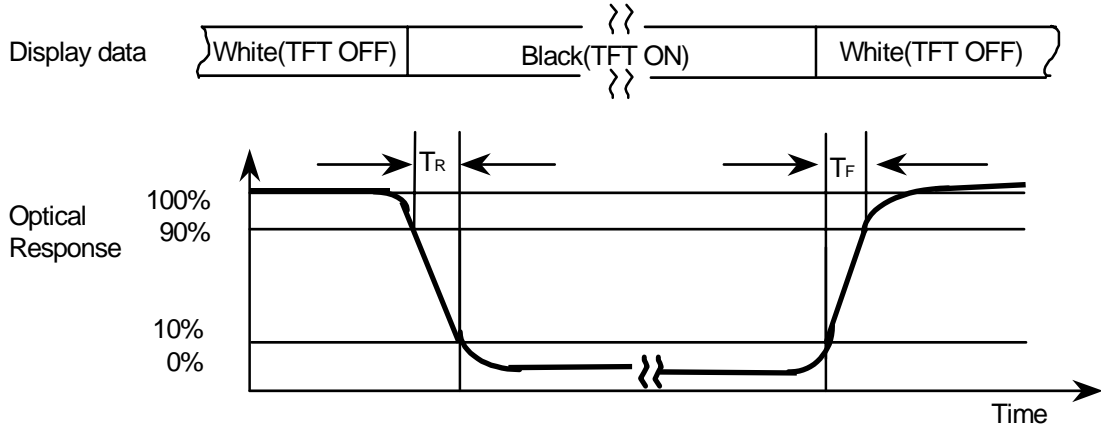

(Note 8-3) Definition of White luminance : Luminance of white at the center point.

(Note 8-4) Definition of viewing angle

