

All information is subject to change without notice. Please read bottom notes.

FEATURES

- (1) 12.1 SVGA color display with High Luminance
- (2) Built in Long Life Lamps(MTTF:50,000 h)
(Condition/ T_a :25°C, I_{FL} :6mA(rms)(continuing lighting), f_{FL} :50kHz)
- (3) Replaceable structure of lamp units and Mounting compatible with LTD121C30S Series
- (4) AR surface coating

TENTATIVE**RoHS compatible****MECHANICAL SPECIFICATIONS**

Item	Specifications
Dimensional Outline (typ.)	278.3 (W) x 209.0 (H) x 11.0max (D) mm
Number of Pixels	800 (W) x 600 (H) pixels
Active Area	246.0 (W) x 184.5 (H) mm
Pixel Pitch	0.3075 (W) x 0.3075 (H)
Weight (approximately)	680g
Backlight	Sidelight (2 CCFLs)

ABSOLUTE MAXIMUM RATINGS

Item	Min.	Max.	Unit	
Supply Voltage	(V_{DD})	-0.3	4.0	V
	(V_{FL})	0	2.0	kV(rms)
FL Driving Frequency	(f_{FL})	---	100	KHz
Input Signal Voltage	(V_{IN})	-0.3	$V_{DD}+0.3$	V
Operating Temperature *1		-10	65	°C
Storage Temperature		-20	80	°C
Storage Humidity (Max. wet bulb temperature = 39°C)		10	90	%(RH)

*1: Wet bulb temperature should be 39°C Max., and no condensation of water.

ELECTRICAL SPECIFICATION ($T_a=25^\circ\text{C}$) (RECOMMENDED OPERATION CONDITION)

Item	Min.	Typ.	Max.	Unit	Remarks	
Supply Voltage	(V_{DD})	3.0	3.3	3.6	V	
	(V_{FL})	---	520	---	V(rms)	
FL Start Voltage	(V_{SFL})	1200	---	1900	V(rms)	$T_a=0^\circ\text{C}$
Differential Input Voltage	(V_{ID})	100	---	600	mV	
Common Mode Input Voltage	(V_{CM})	1.0	---	$2.4-(V_{ID})/2$	V	
Current Consumption	(I_{DD}) ^{*3}	---	390	---	mA	
	(I_{FL}) ^{*4}	3.0	---	6.5	mA(rms)	
Power Consumption *1 *2		---	7.5	---	W	$I_{FL}=6.0\text{mA(rms)}$

*2: The surface temperature caused by self heat radiation of cell itself is specified on this item.

*3: 8 color bars pattern *4: Except the efficiency of FL inverter

OPTICAL SPECIFICATION ($T_a=25^\circ\text{C}$)

Item	Min.	Typ.	Max.	Unit	Remarks
Contrast Ratio	(CR)	250	500	---	
Viewing Angle (CR ≥ 10)	(Upper+Lower)	---	120	---	°
	(Left+Right)	---	140	---	°
Response Time	(t_{ON})	---	10	---	ms
	(t_{OFF})	---	25	---	ms
Luminance	(L)	300	380	---	cd/m ² $I_{FL}=6.0\text{mA(rms)}$
Reflectance(SCI)	(R)	---	1.33	---	No operation
Lamp Life Time (MTBF) ^{*5 *6}		50,000		h	

*5 : Conditions ; $T_a=25^\circ\text{C}$, $I_{FL}=6.0\text{mA(rms)}$, continuous lighting

*6 : Definitions of failure ; 1) Lcd luminance becomes half of the minimum value. 2) Lamp doesn't light normally.

*The information contained herein is presented only as a guide for the applications of our products. No responsibility is assumed by Toshiba Matsushita Display Technology or other rights of the third parties which may result from its use. No license is granted by implication or otherwise under any patent or patent rights of Toshiba Matsushita Display Technology or others.

*The information contained herein may be changed without prior notice. It is therefore advisable to contact Toshiba Matsushita Display Technology before proceeding with the design of equipment incorporating this product.

DIMENSIONAL OUTLINE

TENTATIVE

Unit : mm

Standard tolerance : 0.5

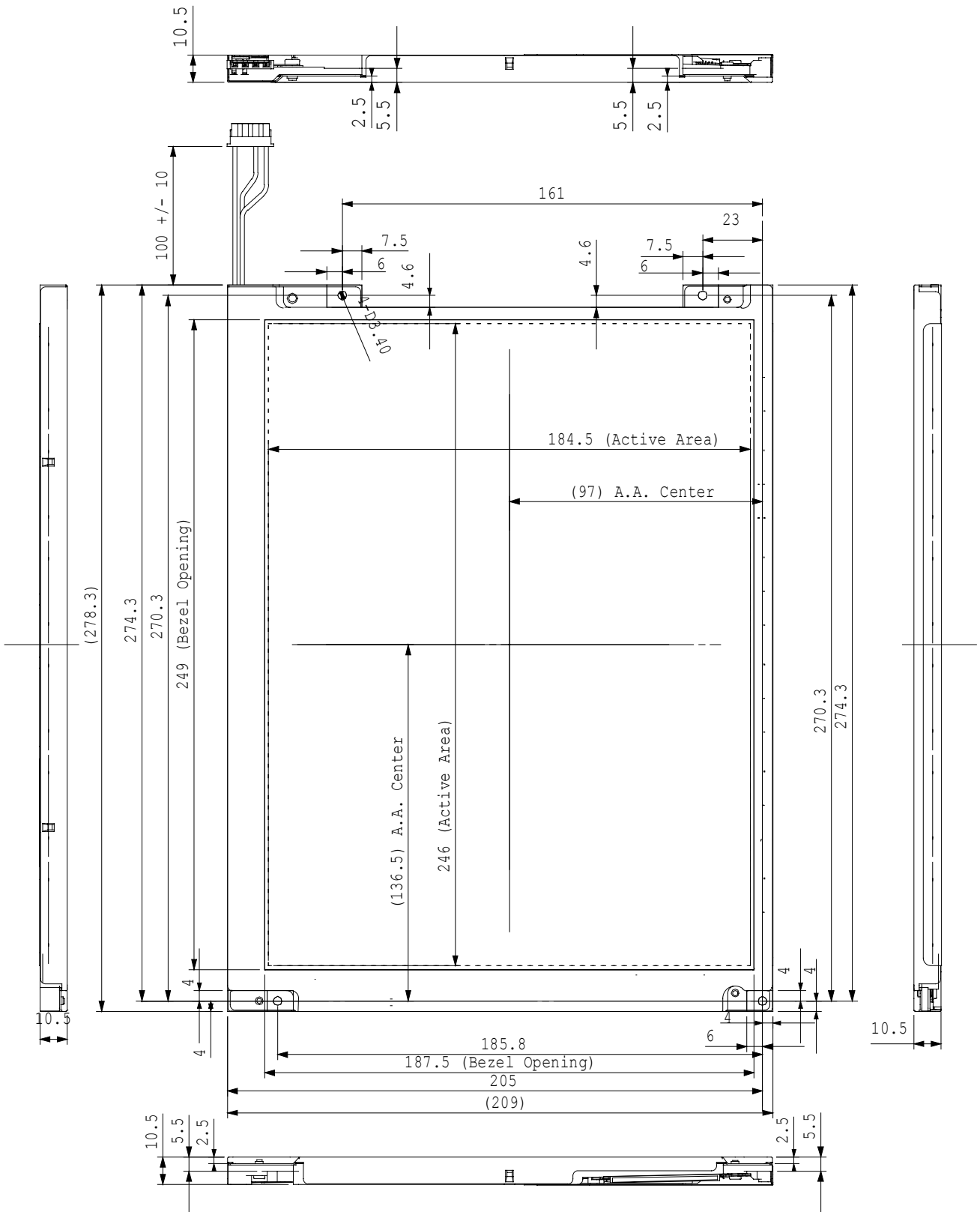

DIMENSIONAL OUTLINE

TENTATIVE

Unit : mm

Standard tolerance : 0.5

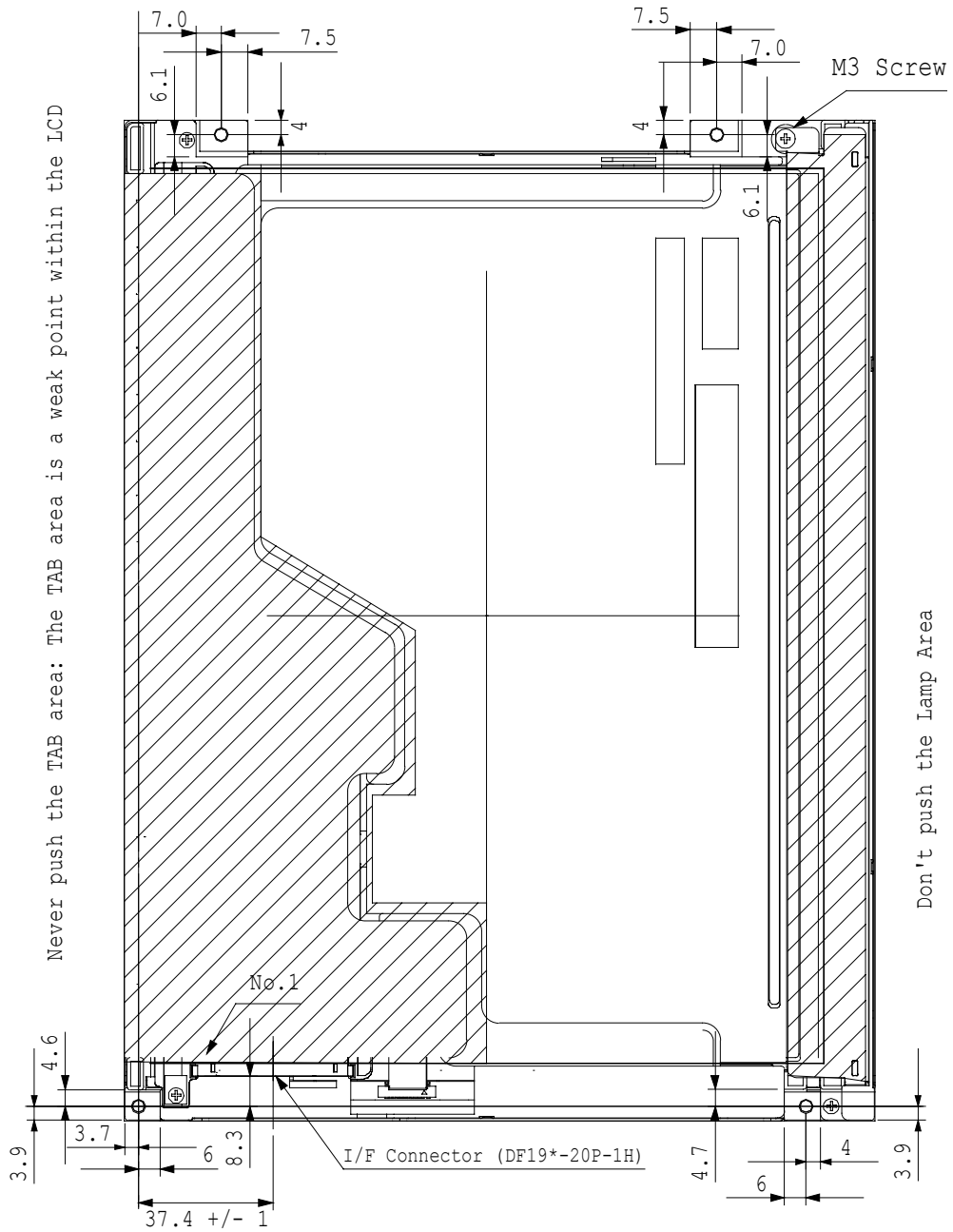

BLOCK DIAGRAM

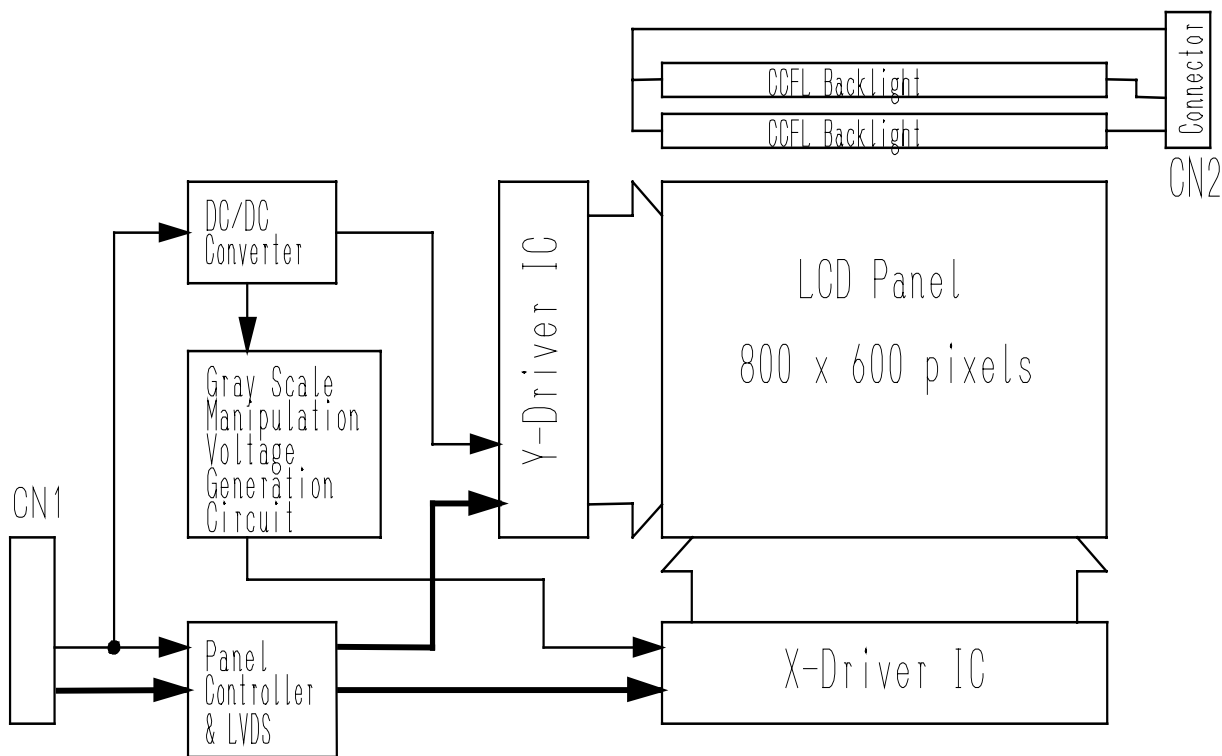

SEQUENCE OF POWER SUPPLIES AND SIGNALS

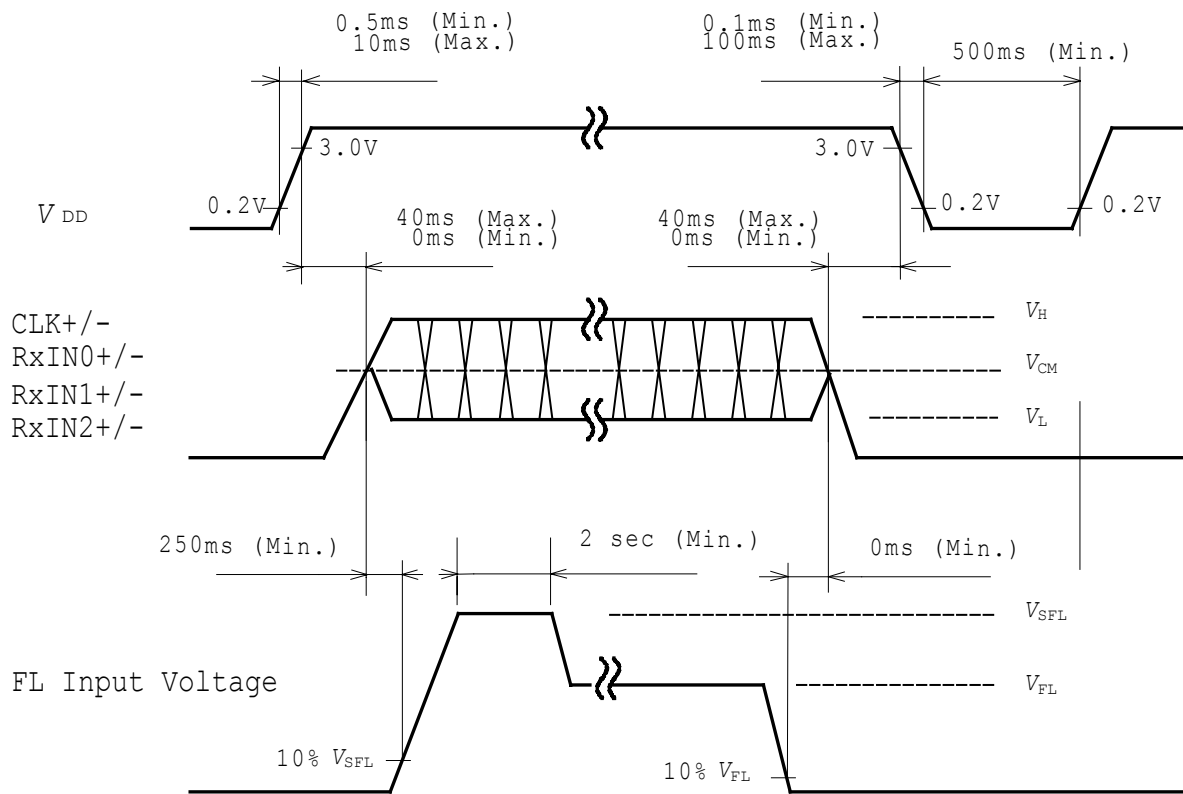

TIMING CHART

<H-Sync/V-Sync+DE Mode>

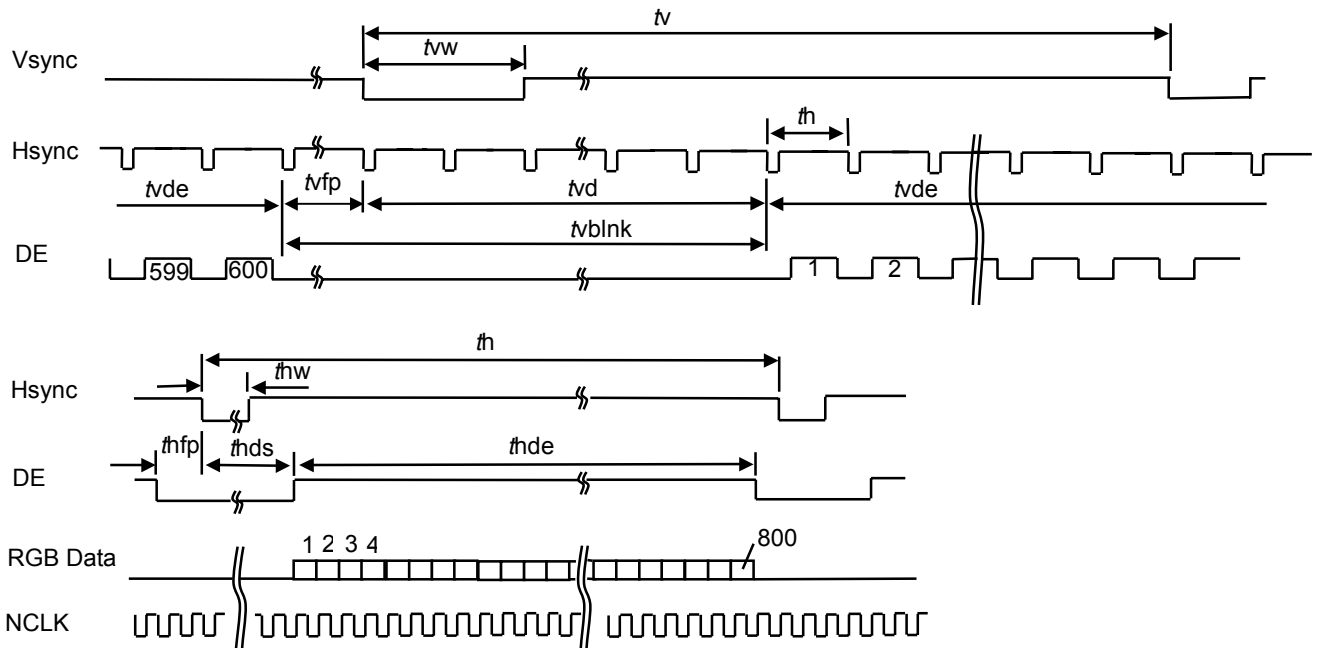

<DE-Only Mode>

(1) Vertical Timing

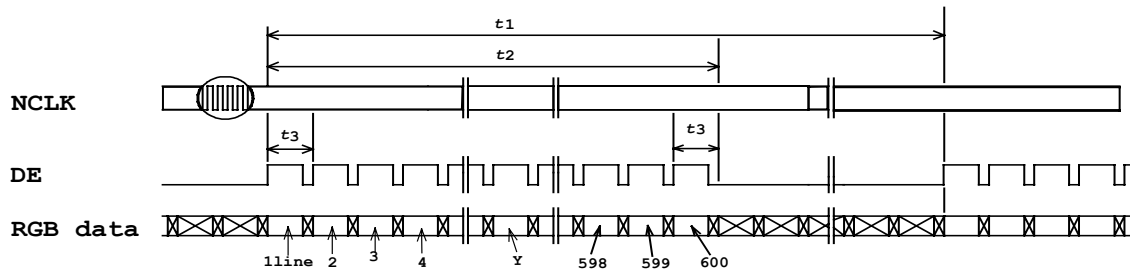

(2) Horizontal Timing

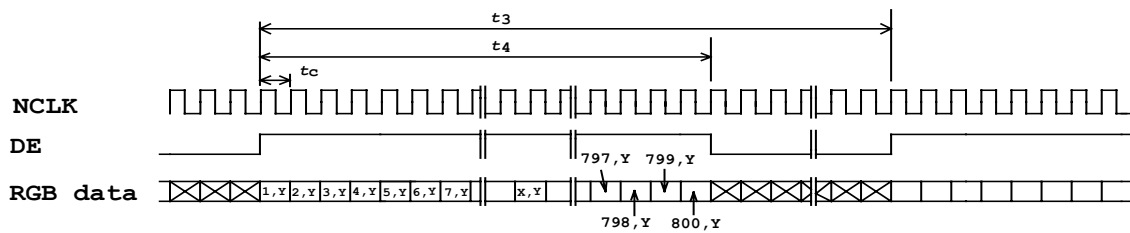

TIMING SPECIFICATION ^{1) 2) 3) 4) 5) 6) 7)}

<H-Sync/V-Sync+DE Mode>

Item	Symbol	min.	typ.	Max.	unit
Frame Period	<i>tv</i>	608	625	628	<i>th</i>
		---	17.78	17.86	ms
Vertical blanking Term	<i>tvblnk</i>	8	25	28	<i>th</i>
V-sync Pulse Width	<i>twv</i>	2	---	---	<i>th</i>
Vertical Front Porch	<i>tvfp</i>	2	---	---	<i>th</i>
Vertical Data Sync Period	<i>tvds</i>	6	---	---	<i>th</i>
Vertical Display Term	<i>tvde</i>	600	600	600	<i>th</i>
Horizontal Period	<i>th</i>	850	1024	1056	<i>tc</i>
		26.4	28.44	---	us
H-sync Pulse Width	<i>thw</i>	8	---	---	<i>tc</i>
Horizontal Front Porch	<i>thfp</i>	8	---	---	<i>tc</i>
Horizontal Data Sync Period	<i>thds</i>	16	---	---	<i>tc</i>
Horizontal Display Term	<i>thde</i>	800	800	800	<i>tc</i>
Clock Period	<i>tc</i>	25.0	27.8	---	ns

< DE-Only Mode>

Item	Symbol	Min.	Typ.	Max.	Unit
Frame Period	<i>t1</i>	608	625 x <i>t3</i>	628 x <i>t3</i>	---
		---	17.78	17.86	ms
Vertical Display Term	<i>t2</i>	600 x <i>t3</i>	600 x <i>t3</i>	600 x <i>t3</i>	---
One Line Scanning Time	<i>t3</i>	850 x <i>tc</i>	1024 x <i>tc</i>	1056 x <i>tc</i>	---
		26.4	28.44	---	us
Horizontal Display Term	<i>t4</i>	800 x <i>tc</i>	800 x <i>tc</i>	800 x <i>tc</i>	---
Clock Period	<i>tc</i>	25.0	27.78	---	ns

Note 1) Refer to "Timing Chart" and LVDS(DS90C365*, DS90C385*) specifications by National Semiconductor Corp.

Note 2) If NCLK is fixed to "H" or "L" level for certain period while DE is supplied, the panel may be damaged.

Note 3) If DE is fixed to "H" or "L" level for certain period while NCLK is supplied, the panel displays black with some flicker.

Note 4) Please adjust LCD operating signal timing and FL driving frequency, to optimize the display quality.

There is a possibility that flicker is observed by the interference of LCD operating signal timing and FL driving condition (especially driving frequency), even if the condition satisfies above timing specifications.

Note 5) Do not make *tv*, *th* and *tvds* fluctuate.

Note 6) In case of using the long frame period, the deterioration of display quality, noise etc. may be occurred.

Note 7) NCLK count of each Horizontal Scanning Time should be always the same.

V-Blanking period should be "*n*" X "Horizontal Scanning Time". (*n*: integer)

Frame period should be always the same.

CONNECTOR PIN ASSIGNMENT FOR INTERFACE**CN1 INPUT SIGNAL**

Connector : DF19L-20P-1H / HIROSE ELECTRIC CO., LTD.

Mating Connector : DF19G-20S-1F(FPC), DF19G-20S-1C(Cable)

Terminal No.	Symbol	Function
1	VDD	Power Supply : +3.3V
2	VDD	Power Supply : +3.3V
3	VSS	GND
4	VSS	GND
5	RxIN0-	Negative LVDS differential data input (R0-R5, G0)
6	RxIN0+	Positive LVDS differential data input (R0-R5, G0)
7	VSS	GND
8	RxIN1-	Negative LVDS differential data input (G1-G5, B0-B1)
9	RxIN1+	Positive LVDS differential data input (G1-G5, B0-B1)
10	VSS	GND
11	RxIN2-	Negative LVDS differential data input (B2-B5, HS, VS, DE)
12	RxIN2+	Positive LVDS differential data input (B2-B5, HS, VS, DE)
13	VSS	GND
14	CLK-	Clock Signal(-)
15	CLK+	Clock Signal(+)
16	VSS	GND
17	U/D	Vertical Reverse("L" level or Open : Normal, "H" level : Reverse)
18	L/R	Horizontal Reverse("L" level or Open : Normal, "H" level : Reverse)
19	NC ²⁾	Non Connection (open)
20	VSS	GND

Note 1) Please connect GND pin to ground. Don't use it as no-connect nor connection with high impedance.

Note 2) NC terminal should be open.

CN2 CCFL POWER SOURCE

Connector : BHR-04VS-1 / JAPAN SOLDERLESS TERMINAL MFG CO., LTD.

Mating Connector³⁾ : SM04(4.0)B-BHS-1 / JAPAN SOLDERLESS TERMINAL MFG CO., LTD.

Terminal No.	Symbol	Function
1	VFLH1	CCFL Power Supply (high voltage)
2	VFLH2	CCFL Power Supply (high voltage)
3	NC ²⁾	Non Connection (open)
4	VFLL	CCFL Power Supply (low voltage)

Note 3) Take away terminal No.3 of the mating connector. If does not take away, it may cause smoke burn of electrical parts by high voltage.

**RECOMMENDED TRANSMITTER (DS90C365* by National Semiconductor Corp.)
TO LTD121C34S INTERFACE ASSIGNMENT**

Case1: 6bit Transmitter

DS90C365*				LTD121C34S Interface (CN1)		
Input Terminal No.		Input Signal (Graphics controller output signal)		Output Signal Symbol		
Symbol	Terminal	Symbol	Function		Terminal	Symbol
TIN0	44	R0	Red Pixels Display Data (LSB)	TOUT0- TOUT0+	No.5 No.6	RxIN0- RxIN0+
TIN1	45	R1	Red Pixels Display Data			
TIN2	47	R2	Red Pixels Display Data			
TIN3	48	R3	Red Pixels Display Data			
TIN4	1	R4	Red Pixels Display Data			
TIN5	3	R5	Red Pixels Display Data (MSB)			
TIN6	4	G0	Green Pixels Display Data (LSB)	TOUT1- TOUT1+	No.8 No.9	RxIN1- RxIN1+
TIN7	6	G1	Green Pixels Display Data			
TIN8	7	G2	Green Pixels Display Data			
TIN9	9	G3	Green Pixels Display Data			
TIN10	10	G4	Green Pixels Display Data			
TIN11	12	G5	Green Pixels Display Data (MSB)			
TIN12	13	B0	Blue Pixels Display Data (LSB)	TOUT2- TOUT2+	No.11 No.12	RxIN2- RxIN2+
TIN13	15	B1	Blue Pixels Display Data			
TIN14	16	B2	Blue Pixels Display Data			
TIN15	18	B3	Blue Pixels Display Data			
TIN16	19	B4	Blue Pixels Display Data			
TIN17	20	B5	Blue Pixels Display Data (MSB)			
TIN18	22	HSYNC	H-Sync	TCLK OUT- TCLK OUT+	No.14 No.15	CLK- CLK+
TIN19	23	VSYNC	V-Sync			
TIN20	25	DE	Compound Synchronization Signal			
CLK IN	26	CLK	Data Sampling Clock			

Note 1) Please connect NC pin to nothing. Don't connect it to ground nor to other signal input.

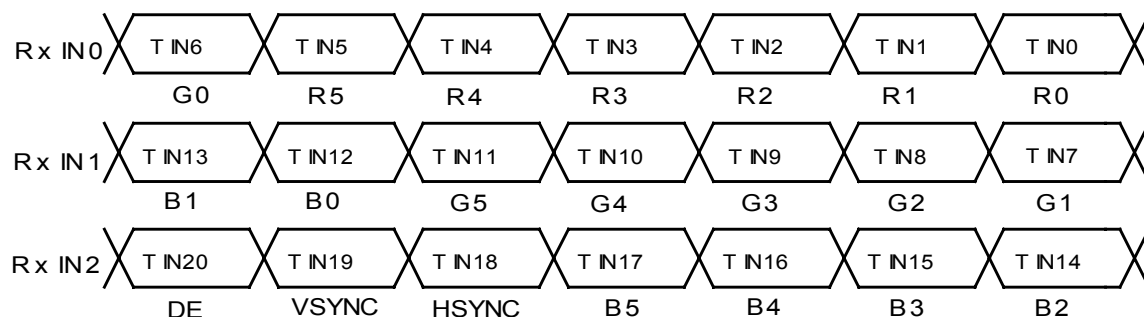

**RECOMMENDED TRANSMITTER (DS90C385* by National Semiconductor Corp.)
TO LTD121C34S INTERFACE ASSIGNMENT**

Case2: 8bit Transmitter

DS90C385*				LTD121C34S Interface (CN1)		
Input Terminal No.		Input Signal (Graphics controller output signal)		Output Signal Symbol	Terminal	Symbol
Symbol	Terminal	Symbol	Function			
TIN0	51	R0	Red Pixels Display Data (LSB)	TOUT0- TOUT0+	No.5 No.6	RxIN0- RxIN0+
TIN1	52	R1	Red Pixels Display Data			
TIN2	54	R2	Red Pixels Display Data			
TIN3	55	R3	Red Pixels Display Data			
TIN4	56	R4	Red Pixels Display Data			
TIN6	3	R5	Red Pixels Display Data (MSB)	TOUT1- TOUT1+	No.8 No.9	RxIN1- RxIN1+
TIN7	4	G0	Green Pixels Display Data(LSB)			
TIN8	6	G1	Green Pixels Display Data			
TIN9	7	G2	Green Pixels Display Data			
TIN12	11	G3	Green Pixels Display Data			
TIN13	12	G4	Green Pixels Display Data			
TIN14	14	G5	Green Pixels Display Data(MSB)			
TIN15	15	B0	Blue Pixels Display Data (LSB)			
TIN18	19	B1	Blue Pixels Display Data			
TIN19	20	B2	Blue Pixels Display Data			
TIN20	22	B3	Blue Pixels Display Data			
TIN21	23	B4	Blue Pixels Display Data			
TIN22	24	B5	Blue Pixels Display Data (MSB)			
TIN24	27	HSYNC	H-Sync			
TIN25	28	VSYNC	V-Sync			
TIN26	30	DE	Compound Synchronization Signal			
TIN27	50	NC	Non Connection (open)	TOUT3- TOUT3+		
TIN5	2	NC	Non Connection (open)			
TIN10	8	NC	Non Connection (open)			
TIN11	10	NC	Non Connection (open)			
TIN16	16	NC	Non Connection (open)			
TIN17	18	NC	Non Connection (open)			
TIN23	25	NC	Non Connection (open)			
CLK IN	31	CLK	Data Sampling Clock	TCLK OUT- TCLK OUT+	No.14 No.15	CLK- CLK+

Note 1) Please connect NC pin to nothing. Don't connect it to ground nor to other signal input.

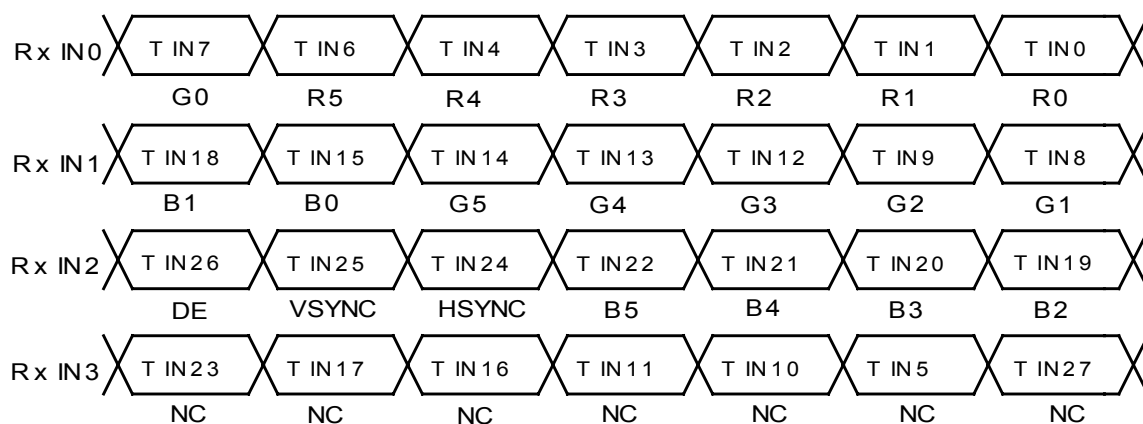

256k (k=1024) COLORS COMBINATION TABLE

	Display	R5 R4 R3 R2 R1 R0	G5 G4 G3 G2 G1 G0	B5 B4 B3 B2 B1 B0	Gray Scale Level
Basic Color	Black	L L L L L L	L L L L L L	L L L L L L	---
	Blue	L L L L L L	L L L L L L	H H H H H H	---
	Green	L L L L L L	H H H H H H	L L L L L L	---
	Light Blue	L L L L L L	H H H H H H	H H H H H H	---
	Red	H H H H H H	L L L L L L	L L L L L L	---
	Purple	H H H H H H	L L L L L L	H H H H H H	---
	Yellow	H H H H H H	H H H H H H	L L L L L L	---
	White	H H H H H H	H H H H H H	H H H H H H	---
Gray Scale of Red	Black	L L L L L L	L L L L L L	L L L L L L	L 0
	Dark ↑ ↓ Light	L L L L L H	L L L L L L	L L L L L L	L 1
		L L L L H L	L L L L L L	L L L L L L	L 2
		: : :	: : :	: : :	L3... L60
		H H H H L H	L L L L L L	L L L L L L	L61
		H H H H H L	L L L L L L	L L L L L L	L62
	Red	H H H H H H	L L L L L L	L L L L L L	Red L63
Gray Scale of Green	Black	L L L L L L	L L L L L L	L L L L L L	L 0
	Dark ↑ ↓ Light	L L L L L L	L L L L L H	L L L L L L	L 1
		L L L L L L	L L L L H L	L L L L L L	L 2
		: : :	: : :	: : :	L3... L60
		L L L L L L	H H H H L H	L L L L L L	L61
		L L L L L L	H H H H H L	L L L L L L	L62
	Green	L L L L L L	H H H H H H	L L L L L L	Green L63
Gray Scale of Blue	Black	L L L L L L	L L L L L L	L L L L L L	L 0
	Dark ↑ ↓ Light	L L L L L L	L L L L L L	L L L L L H	L 1
		L L L L L L	L L L L L L	L L L L H L	L 2
		: : :	: : :	: : :	L3... L60
		L L L L L L	L L L L L L	H H H H L H	L61
		L L L L L L	L L L L L L	H H H H H L	L62
	Blue	L L L L L L	L L L L L L	H H H H H H	Blue L63
Gray Scale of White & Black	Black	L L L L L L	L L L L L L	L L L L L L	L 0
	Dark ↑ ↓ Light	L L L L L H	L L L L L H	L L L L L H	L 1
		L L L L H L	L L L L H L	L L L L H L	L 2
		: : :	: : :	: : :	L3... L60
		H H H H L H	H H H H L H	H H H H L H	L61
		H H H H H L	H H H H H L	H H H H H L	L62
	White	H H H H H H	H H H H H H	H H H H H H	White L63

**FOR SAFETY**

LCD module is generally designed with precise parts to achieve light weighted thin mechanical dimensions. In using our Modules, make certain that you fully understand and put into practice the warnings and safety precautions detailed in Engineering Information No.EE-N001,"CAUTIONS AND INSTRUCTIONS FOR TOSHIBA LCD MODULES". Refer to individual specifications and TECHNICAL DATA sheets (hereinafter called "TD") for more detailed technical information.

1) SPECIAL PURPOSES

A) Toshiba Matsushita Display Technology's Standard LCD Modules have not been customized for operation in extreme environments or for use in applications where performance failures could be life-threatening or otherwise catastrophic.

B) Since Toshiba Matsushita Display Technology's Standard LCD Modules have not been designed for operation in extreme environments, they must never be used in devices that will be exposed to abnormally high levels of vibration or shock which exceed Toshiba Matsushita Display Technology's published specification limits.

C) In addition, since Toshiba Matsushita Display Technology Standard LCD Modules have not been designed for use in applications where performance failures could be life-threatening or catastrophic, they must never be installed in aircraft navigation control systems (such as, but not limited to Traffic Collision Avoidance System and Air Traffic Indicator), in military defense or weapons systems, in critical industrial process-control systems (e.g., those involved in the production of nuclear energy), or in critical medical device or patient life-support systems.

2) DISASSEMBLING OR MODIFICATION

DO NOT DISASSEMBLE OR MODIFY the module. It may damage sensitive parts inside LCD module, and may cause scratches or dust on the display.

Toshiba Matsushita Display Technology does not warrant the module, if customer disassembled or modified it.

3) BREAKAGE OF LCD PANEL

DO NOT INGEST liquid crystal material, DO NOT INHALE this material, and DO NOT CONTACT the material with skin, if LCD panel is broken and liquid crystal material spills out.

If liquid crystal material comes into mouth or eyes, rinse mouth or eyes out with water immediately.

If this material contact with skin or cloths, wash it off immediately with alcohol and rinse thoroughly with water.

4) GLASS OF LCD PANEL

BE CAREFUL WITH CHIPS OF GLASS that may cause injuring fingers or skin, when the glass is broken.

5) ELECTRIC SHOCK

DISCONNECT POWER SUPPLY before handling LCD module.

DO NOT TOUCH the parts inside LCD module and the fluorescent lamp's connector or cables in order to prevent electric shock, because high voltage is supplied to these parts from the inverter unit while power supply is turned on.

6) ABSOLUTE MAXIMUM RATINGS AND POWER PROTECTION CIRCUIT

DO NOT EXCEED the absolute maximum rating values under the worst probable conditions caused by the supply voltage variation, input voltage variation, variation in parts' constants, environmental temperature, etc., otherwise LCD module may be damaged.

Employ protection circuit for power supply, whenever the specification or TD specifies it.

Suitable protection circuit should be applied for each system design.

7) RECOMMENDED OPERATION CONDITIONS

The performance and quality of the LCD panel are warranted only when the LCD panel is used within "the recommended operation conditions". Toshiba Matsushita Display Technology Co., Ltd. never warrants the performance and quality of the LCD panel when you use the LCD panel over "the recommended operation conditions", although within "the absolute maximum rating".

To use the LCD panel over "the recommended operation conditions" may have bad influence on the characteristics and reliability of the LCD panel and may shorten the life of the LCD panel.

Therefore, when designing the whole set, not to be over "the recommended operation conditions", you should fully take care of supply voltage change, characteristic of connection parts, surge of input-and-output line, and surrounding temperature.

8) DISPOSAL

When dispose LCD module, obey to the applicable environmental regulations.