

FEATURES

- * SELECTED TO SPECIFIC ON-LINE INTENSITY AND RADIANT INTENSITY RANGES
- * LOW COST MINIATURE PLASTIC SIDE LOOKING PACKAGE
- * HIGH SPEED

PACKAGE DIMENSIONS

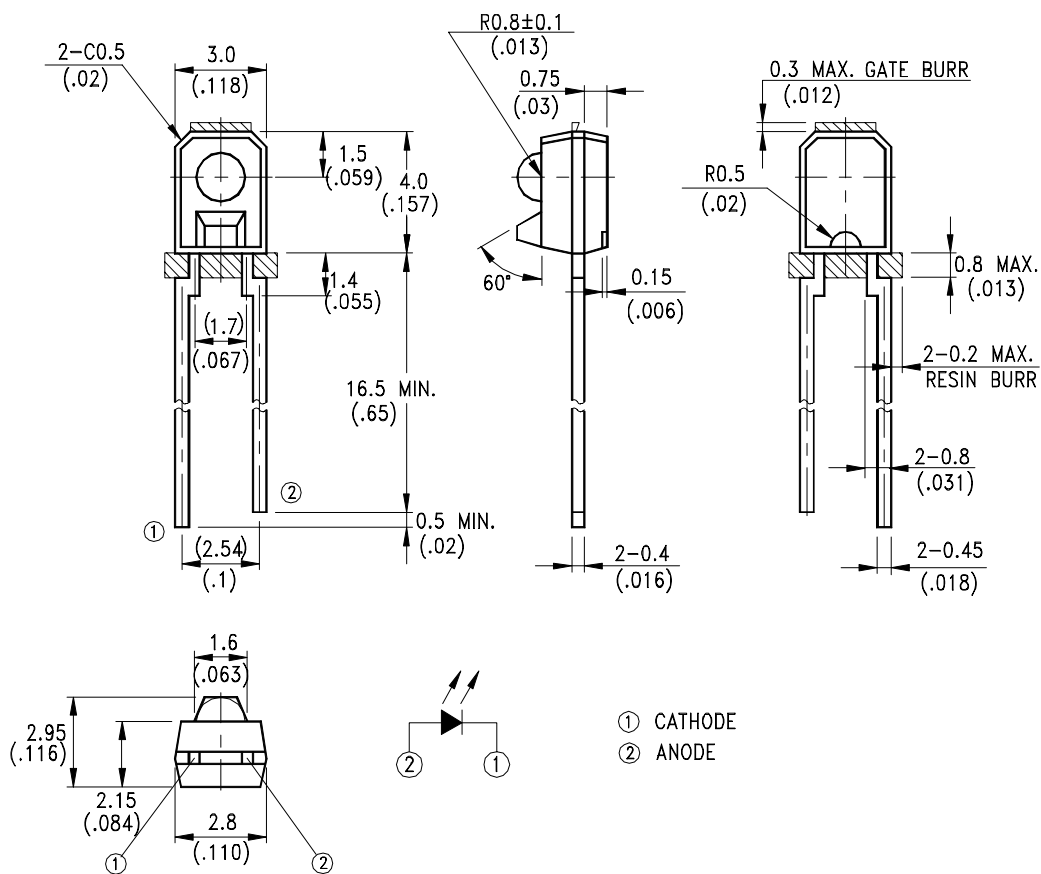

NOTES:

1. All dimensions are in millimeters (inches).
2. Tolerance is $\pm 0.25\text{mm}(.010\text{'})$ unless otherwise noted.
3. Lead spacing is measured where the leads emerge from the package.
4. Specifications are subject to change without notice.

www.DataSheet4U.com



LITE-ON TECHNOLOGY CORPORATION

Property of Lite-On Only

ABSOLUTE MAXIMUM RATINGS AT TA=25°C

PARAMETER	MAXIMUM RATING	UNIT
Power Dissipation	200	mW
Peak Forward Current (300pps, 10 μ s pulse)	1	A
Continuous Forward Current	80	mA
Reverse Voltage	5	V
Operating Temperature Range	-40°C to + 85°C	
Storage Temperature Range	-55°C to + 100°C	
Lead Soldering Temperature [1.6mm(.063") From Body]	260°C for 5 Seconds	

ELECTRICAL OPTICAL CHARACTERISTICS AT TA=25°C

PARAMETER	SYMBOL	MIN.	TYP.	MAX.	UNIT	TEST CONDITION
Aperture Radiant Incidence	Ee	0.350	--	--	mW/c m ²	I _F = 20mA
Radiant Intensity	I _E	2.625	--	--	mW/sr	I _F = 20mA
Peak Emission Wavelength	λ_{Peak}	--	850	--	nm	I _F = 50mA
Spectral Line Half-Width	$\Delta \lambda$	--	50	--	nm	I _F = 50mA
Forward Voltage	V _F	--	1.6	2.0	V	I _F = 50mA
Reverse Current	I _R	--	--	100	μ A	V _R = 5V
Rise/Fall Time	Tr/Tf	--	30	--	nS	10%~90%
Viewing Angle (See FIG.6)	$2\theta_{1/2}$	--	30	--	deg.	

www.DataSheet4U.com

TYPICAL ELECTRICAL / OPTICAL CHARACTERISTICS CURVES

(25°C Ambient Temperature Unless Otherwise Noted)

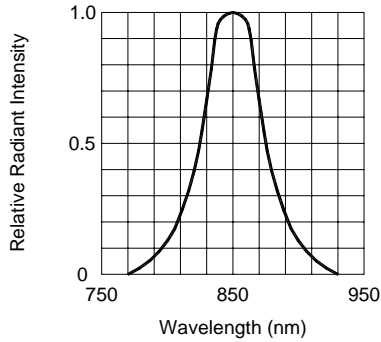

FIG.1 SPECTRAL DISTRIBUTION

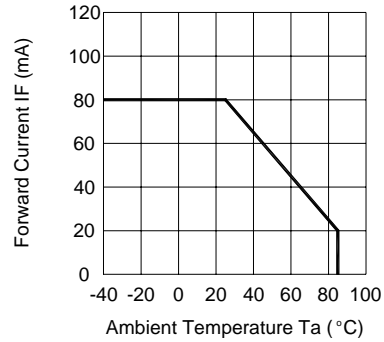

FIG.2 FORWARD CURRENT VS. AMBIENT TEMPERATURE

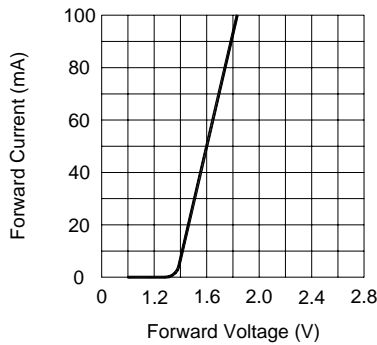

FIG.3 FORWARD CURRENT VS. FORWARD VOLTAGE

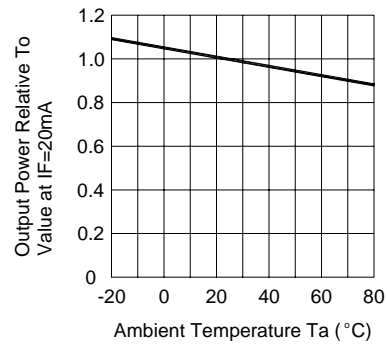

FIG.4 RELATIVE RADIANT INTENSITY VS. AMBIENT TEMPERATURE

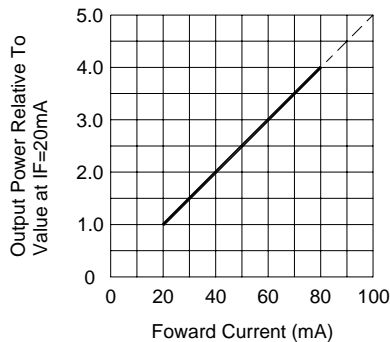

FIG.5 RELATIVE RADIANT INTENSITY VS. FORWARD CURRENT

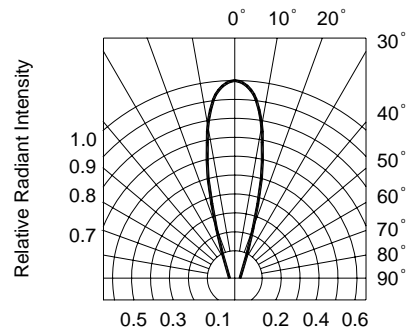

FIG.6 RADIATION DIAGRAM