



# GaAlAs T-1 3/4 Standard 5 $\phi$ Infrared Emitting Diode

LTE-3271T/LTE-3371T/LTE-3271TL/LTE-3371TL

## Features

- Special for high current and low forward voltage.
- High power.
- Available for pulse operating.
- Wide viewing angle.
- LTE-3271TL/LTE-3371TL are blue transparent color package.

## Description

The LTE-3271T/LTE-3371T/LTE-3271TL/LTE-3371TL are high intensity Gallium Aluminum Arsenide infrared emitting diodes mounted in plastic end looking packages. They provide a broad range of intensity selection and are specified under pulsed drive up to 2 Amps.

## Package Dimensions

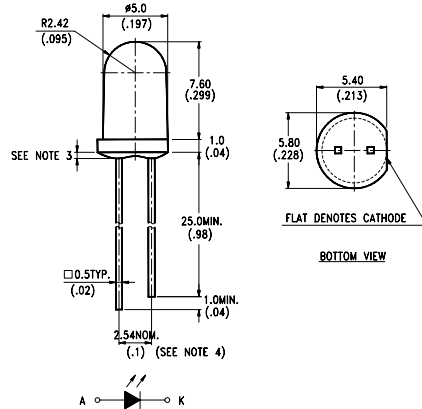

### Notes:

1. All dimensions are in millimeters (inches).
2. Tolerance is  $\pm 0.25\text{mm}$  (.010") unless otherwise noted.
3. Protruded resin under flange is 1.5mm (.059") max.
4. Lead spacing is measured where the leads emerge from the package.
5. Specifications are subject to change without notice.

## Absolute Maximum Ratings at Ta=25°C

Parameter	Maximum Rating	Unit
Power Dissipation	150	mW
Peak Forward Current(300pps, 10 $\mu$ s pulse)	2	A
Continuous Forward Current	100	mA
Reverse Voltage	5	V
Operating Temperature Range	-40°C to +85°C	
Storage Temperature Range	-55°C to +100°C	
Lead Soldering Temperature [1.6mm (.063 in.) from body]	260°C for 5 Seconds	

## Electrical Optical Characteristics at Ta=25°C

Parameter	Symbol	Part No.	Min.	Typ.	Max.	Unit	Test Condition
*Aperture Radiant Incidence	Ee	LTE-3271T	0.80	1.4		mW/cm <sup>2</sup>	If=20mA
		LTE-3271TL					
		LTE-3371T	0.90	1.6			
		LTE-3371TL					
Radiant Intensity	Ie	LTE-3271T	6	10.5		mW/sr	If=20mA
		LTE-3271TL					
		LTE-3371T	6.77	12			
		LTE-3371TL					
Peak Emission Wavelength	$\lambda$ Peak	LTE-3271T		940		nm	If=20mA
		LTE-3271TL					
		LTE-3371T					
		LTE-3371TL					
Spectral Line Half-Width	$\Delta \lambda$			50		nm	If=20mA
Forward Voltage	VF	LTE-3271T		1.25	1.6	V	If=50mA
		LTE-3271TL					
		LTE-3371T					
		LTE-3371TL					
Forward Voltage	VF	LTE-3271T		1.65	2.1	V	If=250mA
		LTE-3271TL					
		LTE-3371T					
		LTE-3371TL					
Reverse Current	IR				100	$\mu$ A	VR=5V
View Angle (See Fig. 6)	$2 \theta^{1/2}$	LTE-3271T		50		deg	
		LTE-3271TL					
		LTE-3371T	40				
		LTE-3371TL					

Note: \*Ee is a measurement of the average radiant incidence upon a sensing area 1cm<sup>2</sup> in perpendicular to and centered on the mechanical axis of the lens and 26.8mm from lens.

# Typical Electrical/Optical Characteristic Curves (25°C Ambient Temperature Unless Otherwise Noted)

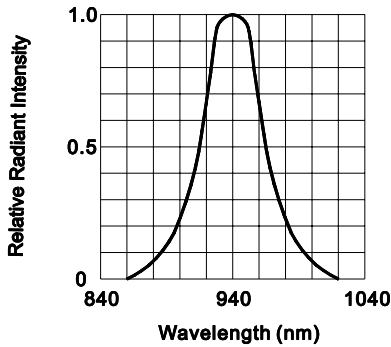

FIG.1 SPECTRAL DISTRIBUTION

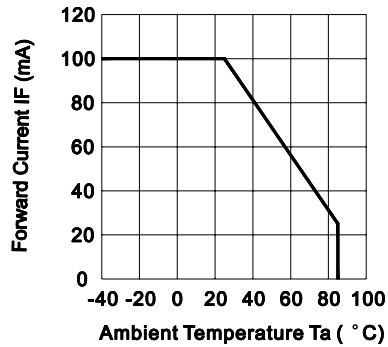

FIG.2 FORWARD CURRENT VS. AMBIENT TEMPERATURE

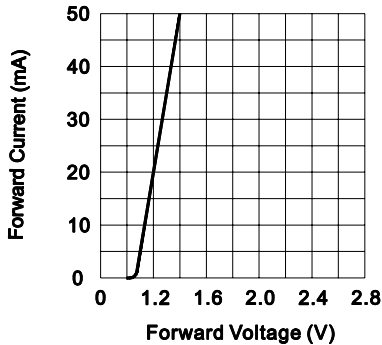

FIG.3 FORWARD CURRENT VS. FORWARD VOLTAGE

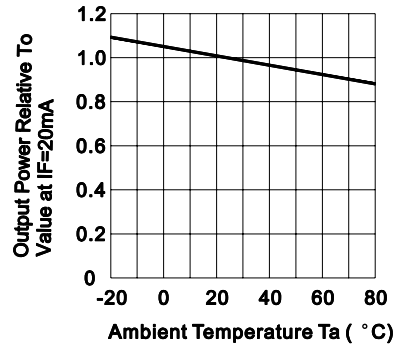

FIG.4 RELATIVE RADIANT INTENSITY VS. AMBIENT TEMPERATURE

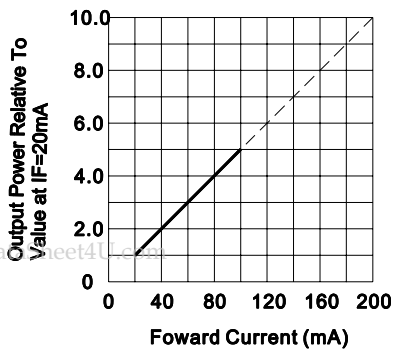

FIG.5 RELATIVE RADIANT INTENSITY VS. FORWARD CURRENT

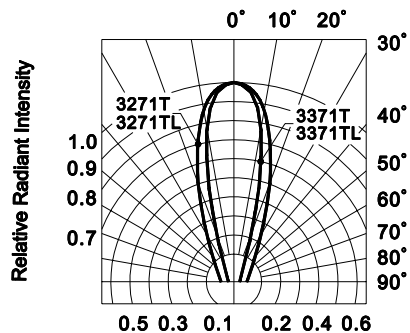

FIG.6 RADIATION DIAGRAM