

TOSHIBA

LIQUID CRYSTAL DISPLAY DIVISION
PRODUCT INFORMATION

21cm COLOUR TFT-LCD MODULE
(8.4 TYPE)
LTM08C343S
(p-Si TFT)

FEATURES

- (1) 8.4"SVGA display size for notebook PC
- (2) Slim(5.8mmMAX) & light weight(190gTYP) design

TENTATIVE

MECHANICAL SPECIFICATIONS

Item	Specifications
Dimensional Outline (Typ.)	201.4(W) x 140.3(H) x 5.8max(D) mm
Number of Pixels	800 (W) x 600 (H) pixels
Active Area	170.4(W) x 127.8 (H) mm
Pixel Pitch	0.213(W) x 0.213 (H)
Weight (approximately)	190g
Backlight	Single CCFL, Sidelight type

ABSOLUTE MAXIMUM RATINGS

Item	Min.	Max.	Unit	
Supply Voltage	(V _{DD})	-0.3	4.5	V
	(V _{FL})	0	2.0	kV(rms)
FL Driving Frequency (f _{FL})	-	100	kHz	
Input Signal Voltage (V _{IN})	-0.3	V _{DD} +0.3	V	
Operating Temperature	0	50	°C	
Storage Temperature	-20	60	°C	
Storage Humidity (Max. wet bulb temp. = 39°C)	10	90	%(RH)	

ELECTRICAL SPECIFICATION

Item	Min.	Typ.	Max.	Unit	Remarks	
Supply Voltage	(V _{DD})	3.0	3.3	3.6	V	
	(V _{FL})	425	475	525	V(rms)	I _{FL} =2.7 mA(rms)
FL Start Voltage (T _a =0°C)	1000	---	1600	V(rms)		
High Level Input Voltage (V _{IH})	0.8 V _{DD}	---	V _{DD}	V		
Low Level Input Voltage (V _{IL})	0	---	0.2 V _{DD}	V		
Current Consumption	*1 (I _{DD})	---	240	mA		
	*2 (I _{FL})	2.2	2.7	5.0	mA(rms)	
*2 *3 Power Consumption	---	2.1	---	W	@70cd/m ²	

*1 : 8 color bars pattern

*2 : Excepting the efficiency FL inverter

*3 : Not use Hsync nor Vsync. Only ENAB control

OPTICAL SPECIFICATION (T_a=25°C)

Item	Min.	Typ.	Max.	Unit	Remarks
Contrast Ratio (CR)	100	250	---	---	
Response Time	(t _{ON})	---	50	ms	
	(t _{OFF})	---	50	ms	
Luminance (L)	50	70	---	cd/m ²	I _{FL} =2.7mA(rms)
	90	130	---	cd/m ²	I _{FL} =5mA(rms)

*The information contained herein is presented only as a guide for the applications of our products. No responsibility is assumed by Toshiba or other rights of the third parties which may result from its use. No license is granted by implication or otherwise under any patent or patent rights of Toshiba or others.

*The information contained herein may be changed without prior notice. It is therefore advisable to contact Toshiba before proceeding with the design of equipment incorporating this product.

Unit : mm

Standard tolerance : +/- 0.5

DIMENSIONAL OUTLINE (front figure)

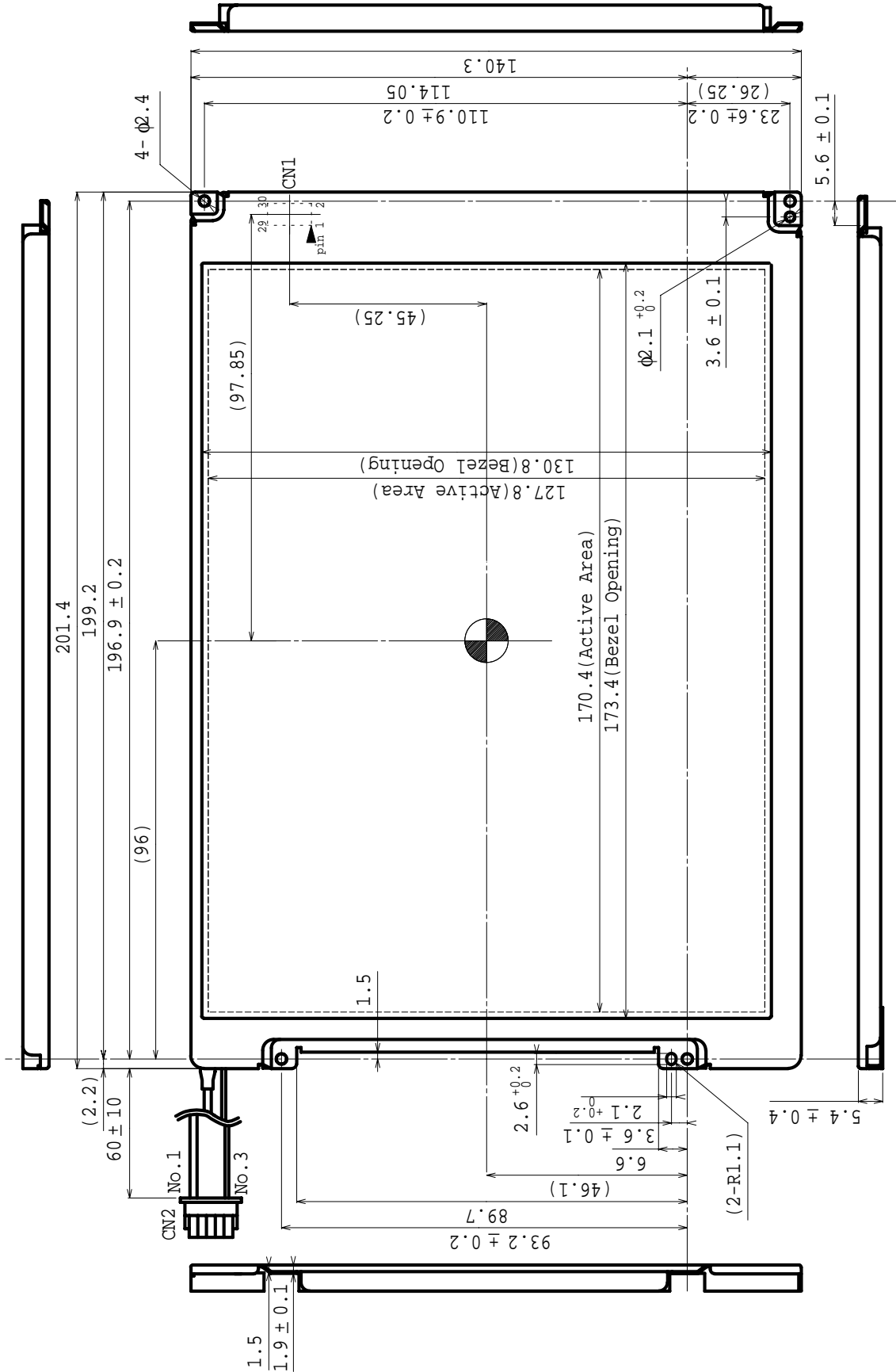

BLOCK DIAGRAM

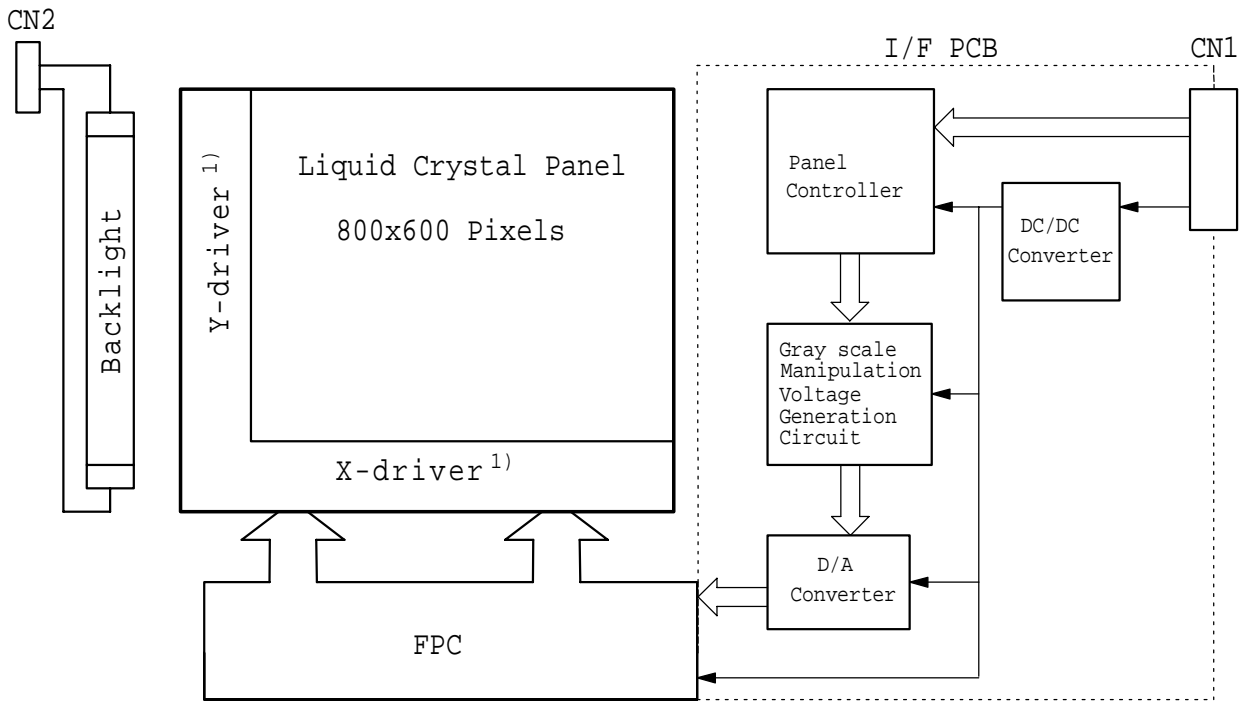

Note1) Build up LCD drivers on the glass substrate

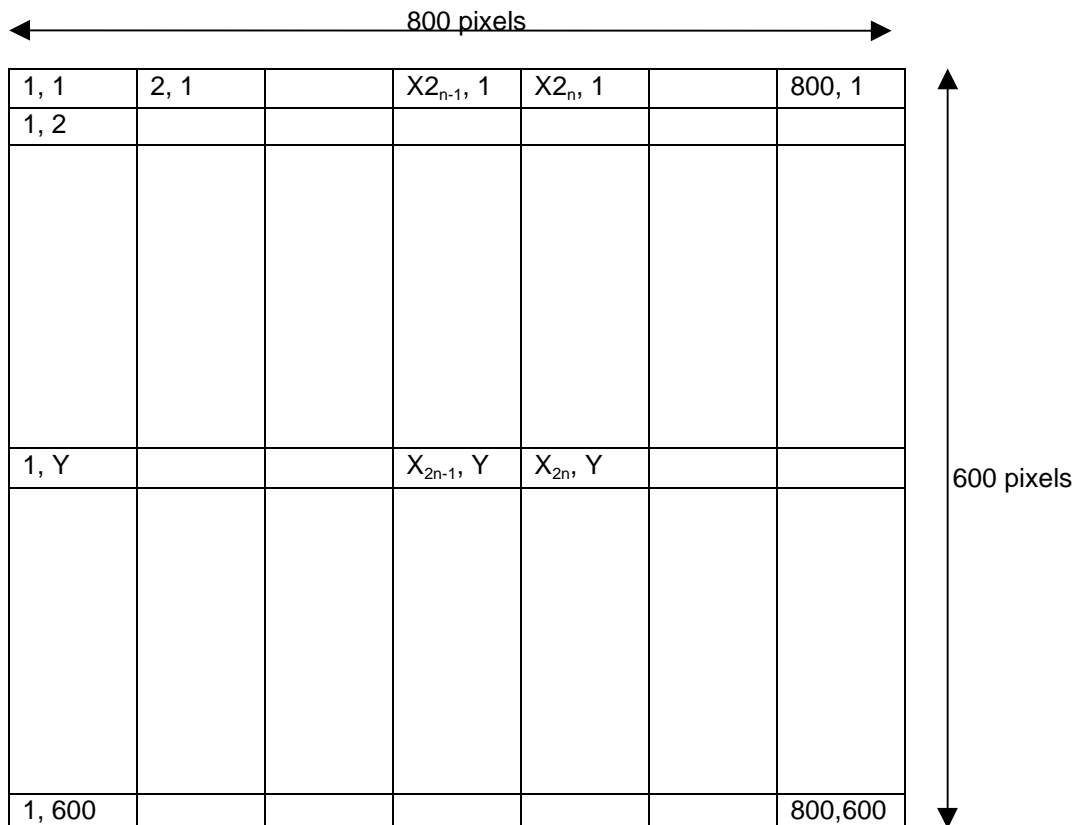

TIMING CHART

(1) Vertical Timing

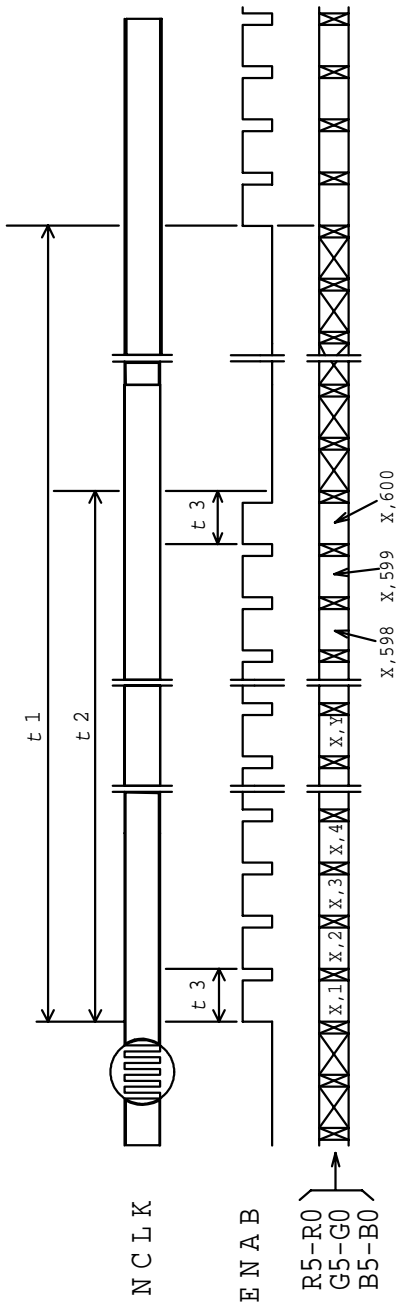

(2) Horizontal Timing

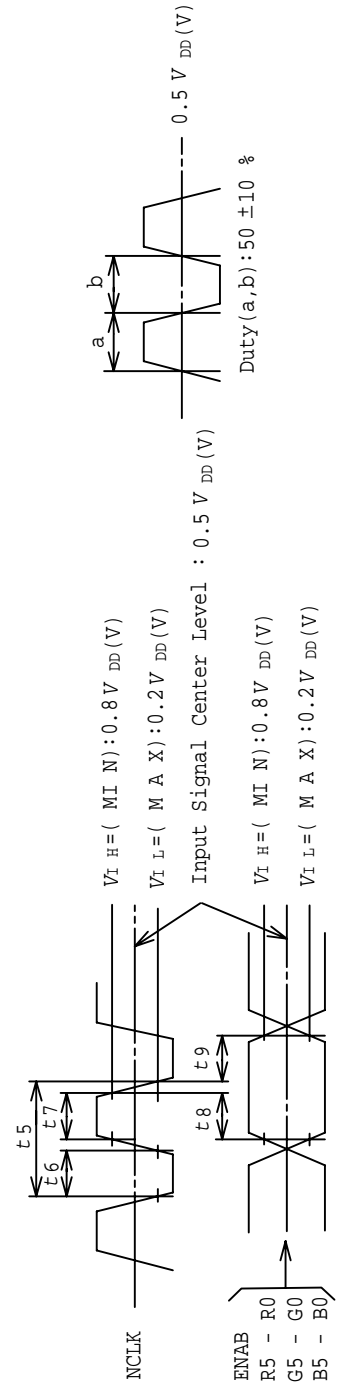
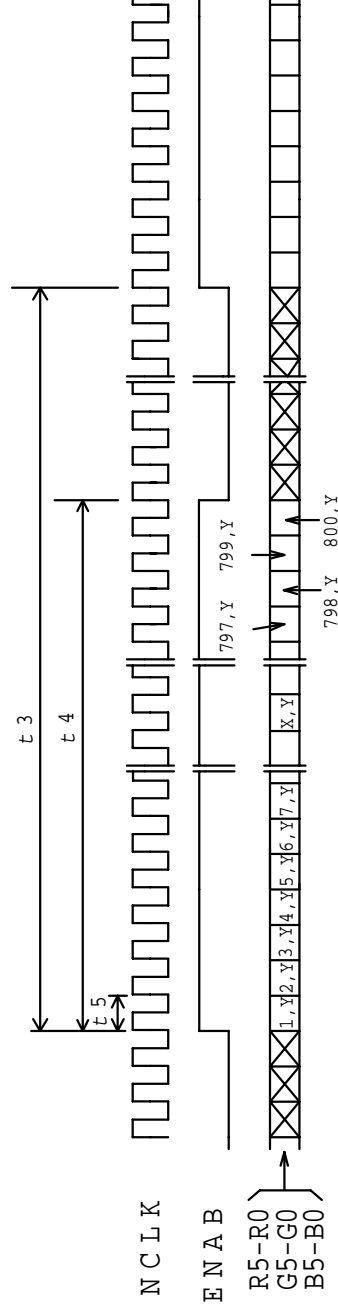

TIMING SPECIFICATION ^{1) 2) 3) 4) 5)}

Item	Symbol	Min.	Typ.	Max.	Unit	Remarks
Frame Period	t_1	604 x t_3	628 x t_3 16.58	628 x t_3 17.86	---	1)
Vertical Display Term	t_2	600 x t_3	600 x t_3	600 x t_3	---	1)
One Line Scanning Time	t_3	1000 x t_5 26.3	1056 x t_5 26.4	1056 x t_5 ---	---	1)
Horizontal Display Term	t_4	800 x t_5	800 x t_5	800 x t_5	---	1)
Clock Period	t_5	24.7	25.0	27.8	ns	
Clock "L" Time	t_6	9.0	---	---	ns	
Clock "H" Time	t_7	9.0	---	---	ns	
Set Up Time	t_8	4.0	---	---	ns	
Hold Time	t_9	6.0	---	---	ns	

Note 1) When ENAB is fixed to "H" level or "L" level after NCLK input, the panel is displayed as black. However, it may be occurred a flicker on the display.

Note 2) When NCLK is fixed to "H" level or "L" level, the panel becomes white stage after several seconds.

Note 3) Do not change t_1 and t_3 values in the operation. When t_1 or t_3 is changed, the panel is displayed as black.

Note 4) Please adjust LCD operating signal timing and FL driving frequency, to optimize the display quality. There is a possibility that flicker is observed by the interference of LCD operating signal timing and FL driving condition (especially driving frequency).

Note 5) Do not hold NCLK on "H" level nor "L" level during V_{DD} (3.3V) is supplied. When it holds on, DC voltage supplies to liquid crystal materials and it may cause damage to liquid crystal materials.

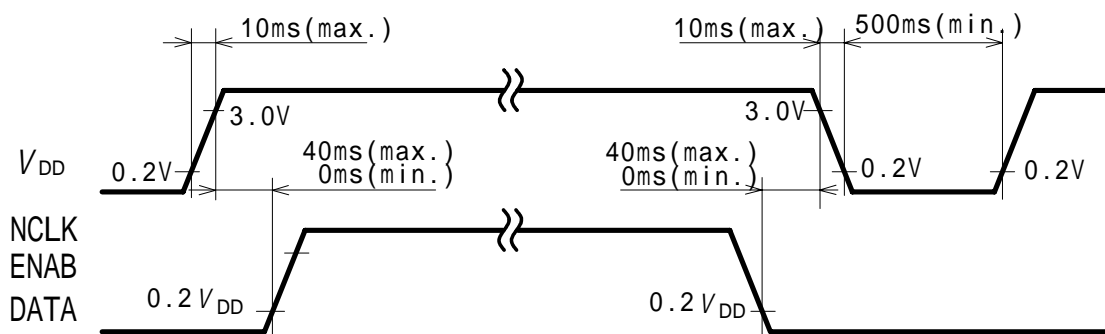
SEQUENCE OF POWER SUPPLIES AND SIGNALS

CONNECTOR PIN ASSIGNMENT FOR INTERFACE

CN1 INPUT SIGNAL

Connector : SD-53885-0301/JAPAN MOLEX CO., LTD.

Mating Connector : SD-54102-0301

Terminal No.	Symbol	
1	GND ³⁾	
2	GND ³⁾	
3	NCLK	SAMPLING CLOCK
4	GND ³⁾	
5	R0 ²⁾	RED DISPLAY DATA (LSB)
6	R1 ²⁾	RED DISPLAY DATA
7	R2 ²⁾	RED DISPLAY DATA
8	R3 ²⁾	RED DISPLAY DATA
9	R4 ²⁾	RED DISPLAY DATA
10	R5 ²⁾	RED DISPLAY DATA (MSB)
11	GND ³⁾	
12	G0 ²⁾	GREEN DISPLAY DATA (LSB)
13	G1 ²⁾	GREEN DISPLAY DATA
14	G2 ²⁾	GREEN DISPLAY DATA
15	G3 ²⁾	GREEN DISPLAY DATA
16	G4 ²⁾	GREEN DISPLAY DATA
17	G5 ²⁾	GREEN DISPLAY DATA (MSB)
18	GND ³⁾	
19	B0 ²⁾	BLUE DISPLAY DATA (LSB)
20	B1 ²⁾	BLUE DISPLAY DATA
21	B2 ²⁾	BLUE DISPLAY DATA
22	B3 ²⁾	BLUE DISPLAY DATA
23	B4 ²⁾	BLUE DISPLAY DATA
24	B5 ²⁾	BLUE DISPLAY DATA (MSB)
25	GND ³⁾	
26	ENAB	COMPOUND SYNCHRONIZATION SIGNAL
27	V _{DD}	+3.3V POWER SUPPLY
28	V _{DD}	+3.3V POWER SUPPLY
29	GND ³⁾	
30	GND ³⁾	

CN2 CCFL POWER SOURCE

Connector : BHR-03VS-1/JAPAN SOLDERLESS TERMINAL MFG CO., LTD.

Mating Connector : SM02(8.0)B-BHS/JAPAN SOLDERLESS TERMINAL MFG CO., LTD.

Terminal No.	Symbol	Function
1	VFLH	CCFL POWER SUPPLY (HIGH VOLTAGE)
2	NC ¹⁾	
3	VFLL	CCFL POWER SUPPLY (LOW VOLTAGE)

Note 1) NC Terminal is open. (Don't use)

Note 2) See next page.

Note 3) Please connect GND pin to ground.

Don't use it as no-connect nor connection with high impedance.

256k (k=1024) COLORS COMBINATION TABLE

	Display	R5 R4 R3 R2 R1 R0	G5 G4 G3 G2 G1 G0	B5 B4 B3 B2 B1 B0	Gray Scale Level
Basic Color	Black	L L L L L L L	L L L L L L L	L L L L L L L	-
	Blue	L L L L L L L	L L L L L L L	H H H H H H H	-
	Green	L L L L L L L	H H H H H H H	L L L L L L L	-
	Light Blue	L L L L L L L	H H H H H H H	H H H H H H H	-
	Red	H H H H H H H	L L L L L L L	L L L L L L L	-
	Purple	H H H H H H H	L L L L L L L	H H H H H H H	-
	Yellow	H H H H H H H	H H H H H H H	L L L L L L L	-
	White	H H H H H H H	H H H H H H H	H H H H H H H	-
Gray Scale of Red	Black	L L L L L L L	L L L L L L L	L L L L L L L	L 0
	Dark ↑ ↓ Light	L L L L L L H	L L L L L L L	L L L L L L L	L 1
		L L L L L H L	L L L L L L L	L L L L L L L	L 2
		: :	: :	: :	L3... L60
		H H H H L H	L L L L L L L	L L L L L L L	L61
	H H H H H L	L L L L L L L	L L L L L L L	L62	
Red	H H H H H H H	L L L L L L L	L L L L L L L	Red L63	
Gray Scale of Green	Black	L L L L L L L	L L L L L L L	L L L L L L L	L 0
	Dark ↑ ↓ Light	L L L L L L L	L L L L L L H	L L L L L L L	L 1
		L L L L L L L	L L L L L H L	L L L L L L L	L 2
		: :	: :	: :	L3... L60
		L L L L L L L	H H H H L H	L L L L L L L	L61
	L L L L L L L	H H H H H L	L L L L L L L	L62	
Green	L L L L L L L	H H H H H H H	L L L L L L L	Green L63	
Gray Scale of Blue	Black	L L L L L L L	L L L L L L L	L L L L L L L	L 0
	Dark ↑ ↓ Light	L L L L L L L	L L L L L L L	L L L L L L H	L 1
		L L L L L L L	L L L L L L L	L L L L L H L	L 2
		: :	: :	: :	L3... L60
		L L L L L L L	L L L L L L L	H H H H L H	L61
	L L L L L L L	L L L L L L L	H H H H H L	L62	
Blue	L L L L L L L	L L L L L L L	H H H H H H H	Blue L63	
Gray Scale of White & Black	Black	L L L L L L L	L L L L L L L	L L L L L L L	L 0
	Dark ↑ ↓ Light	L L L L L L H	L L L L L L H	L L L L L L H	L 1
		L L L L L H L	L L L L L H L	L L L L L H L	L 2
		: :	: :	: :	L3... L60
		H H H H L H	H H H H L H	H H H H L H	L61
	H H H H H L	H H H H H L	H H H H H L	L62	
White	H H H H H H H	H H H H H H H	H H H H H H H	White L63	

**FOR SAFETY**

LCD module is generally designed with precise parts to achieve light weighted thin mechanical dimensions. In using our Modules, make certain that you fully understand and put into practice the warnings and safety precautions detailed in Engineering Information No.EE-N001,"CAUTIONS AND INSTRUCTIONS FOR TOSHIBA LCD MODULES". Refer to individual specifications and TECHNICAL DATA sheets (hereinafter called "TD") for more detailed technical information.

1) SPECIAL PURPOSES

A) Toshiba's Standard LCD Modules have not been customized for operation in extreme environments or for use in applications where performance failures could be life-threatening or otherwise catastrophic.

B) Since Toshiba's Standard LCD Modules have not been designed for operation in extreme environments, they must never be used in devices that will be exposed to abnormally high levels of vibration or shock which exceed Toshiba's published specification limits.

C) In addition, since Toshiba Standard LCD Modules have not been designed for use in applications where performance failures could be life-threatening or catastrophic, they must never be installed in aircraft navigation control systems (such as, but not limited to Traffic Collision Avoidance System and Air Traffic Indicator), in military defense or weapons systems, in critical industrial process-control systems (e.g., those involved in the production of nuclear energy), or in critical medical device or patient life-support systems.

2) DISASSEMBLING OR MODIFICATION

DO NOT DISASSEMBLE OR MODIFY the module. It may damage sensitive parts inside LCD module, and may cause scratches or dust on the display.

Toshiba does not warrant the module, if customer disassembled or modified it.

3) BREAKAGE OF LCD PANEL

DO NOT INGEST liquid crystal material, DO NOT INHALE this material, and DO NOT CONTACT the material with skin, if LCD panel is broken and liquid crystal material spills out.

If liquid crystal material comes into mouth or eyes, rinse mouth or eyes out with water immediately.

If this material contact with skin or cloths, wash it off immediately with alcohol and rinse thoroughly with water.

4) GLASS OF LCD PANEL

BE CAREFUL WITH CHIPS OF GLASS that may cause injuring fingers or skin, when the glass is broken.

5) ELECTRIC SHOCK

DISCONNECT POWER SUPPLY before handling LCD module.

DO NOT TOUCH the parts inside LCD module and the fluorescent lamp's connector or cables in order to prevent electric shock, because high voltage is supplied to these parts from the inverter unit while power supply is turned on.

6) ABSOLUTE MAXIMUM RATINGS AND POWER PROTECTION CIRCUIT

DO NOT EXCEED the absolute maximum rating values under the worst probable conditions caused by the supply voltage variation, input voltage variation, variation in parts' constants, environmental temperature, etc., otherwise LCD module may be damaged.

Employ protection circuit for power supply, whenever the specification or TD specifies it.

Suitable protection circuit should be applied for each system design.

7) DISPOSAL

When dispose LCD module, obey to the applicable environmental regulations.