

TOSHIBA

LIQUID CRYSTAL DISPLAY DIVISION
PRODUCT INFORMATION

26cm COLOUR TFT-LCD MODULE
(10.4 TYPE)
LTM10C209A
(a-Si TFT)

FEATURES

- (1) 10.4" VGA color display with High Luminance
- (2) Built in Long Life Lamps(30,000 h)
- (3) Replaceable structure of lamp units
- (4) Full mechanical compatible with LTM10C273 (10.4" SVGA)

TENTATIVE

MECHANICAL SPECIFICATIONS

| Item | Specifications |
|----------------------------|-----------------------------------|
| Dimensional Outline (typ.) | 265.0(W) x 188.8(H) x 12max(D) mm |
| Number of Pixels | 640(W) x 480(H) pixels |
| Active Area | 211.2(W) x 158.4(H) mm |
| Pixel Pitch | 0.33(W) x 0.33(H) |
| Weight (approximately) | 590g |
| Backlight | Twin CCFLs, Sidelight type |

ABSOLUTE MAXIMUM RATINGS

| Item | Min. | Max. | Unit | |
|--|--------------------|----------------------|-------|---------|
| Supply Voltage | (V _{DD}) | -0.3 | 7.0 | V |
| | (V _{FL}) | 0 | 2.0 | kV(rms) |
| FL Driving Frequency (f _{FL}) | 0 | 100 | kHz | |
| Input Signal Voltage (V _{IN}) | -0.3 | V _{DD} +0.3 | V | |
| Operating Temperature | 0 | 50 | °C | |
| Storage Temperature | -20 | 60 | °C | |
| Storage Humidity (Max. wet bulb temperature = 39°C) | 10 | 90 | %(RH) | |

ELECTRICAL SPECIFICATION (T_a=25°C)

| Item | Min. | Typ. | Max. | Unit | Remarks | |
|---|----------------------------------|------|-----------------|--------|-----------------------------|--|
| Supply Voltage | (V _{DD}) | 4.75 | 5.0 | 5.25 | V | |
| | (V _{FL}) | 500 | 550 | 600 | V(rms) | |
| FL Start Voltage | 1500 | --- | 1800 | V(rms) | T _a =0°C | |
| High Level Input Voltage (V _{IH}) | 3.5 | --- | V _{DD} | | | |
| Low Level Input Voltage (V _{IL}) | 0 | --- | 1.5 | V | | |
| Current Consumption | ^{*1} (I _{DD}) | --- | 125 | 250 | mA | |
| | ^{*2} (I _{FL}) | 3.0 | 6.0 | 7.0 | mA(rms) | |
| ^{*1 *2} Power Consumption | --- | 7.2 | --- | W | I _{FL} =6.0mA(rms) | |

*1 : 8 color bars pattern

*2 : Except the efficiency of FL inverter

OPTICAL SPECIFICATION (T_a=25°C)

| Item | Min. | Typ. | Max. | Unit | Remarks | |
|---------------------|---------------------|------|------|-------------------|-----------------------------|--|
| Contrast Ratio (CR) | 100 | 250 | --- | --- | | |
| Response Time | (t _{ON}) | --- | --- | 50 | ms | |
| | (t _{OFF}) | --- | --- | 50 | ms | |
| Luminance (L) | 190 | 250 | --- | cd/m ² | I _{FL} =6.0mA(rms) | |

*The information contained herein is presented only as a guide for the applications of our products. No responsibility is assumed by Toshiba or other rights of the third parties which may result from its use. No license is granted by implication or otherwise under any patent or patent rights of Toshiba or others.

*The information contained herein may be changed without prior notice. It is therefore advisable to contact Toshiba before proceeding with the design of equipment incorporating this product.

DIMENSIONAL OUTLINE

TENTATIVE

Unit : mm

Standard tolerance : 0.5

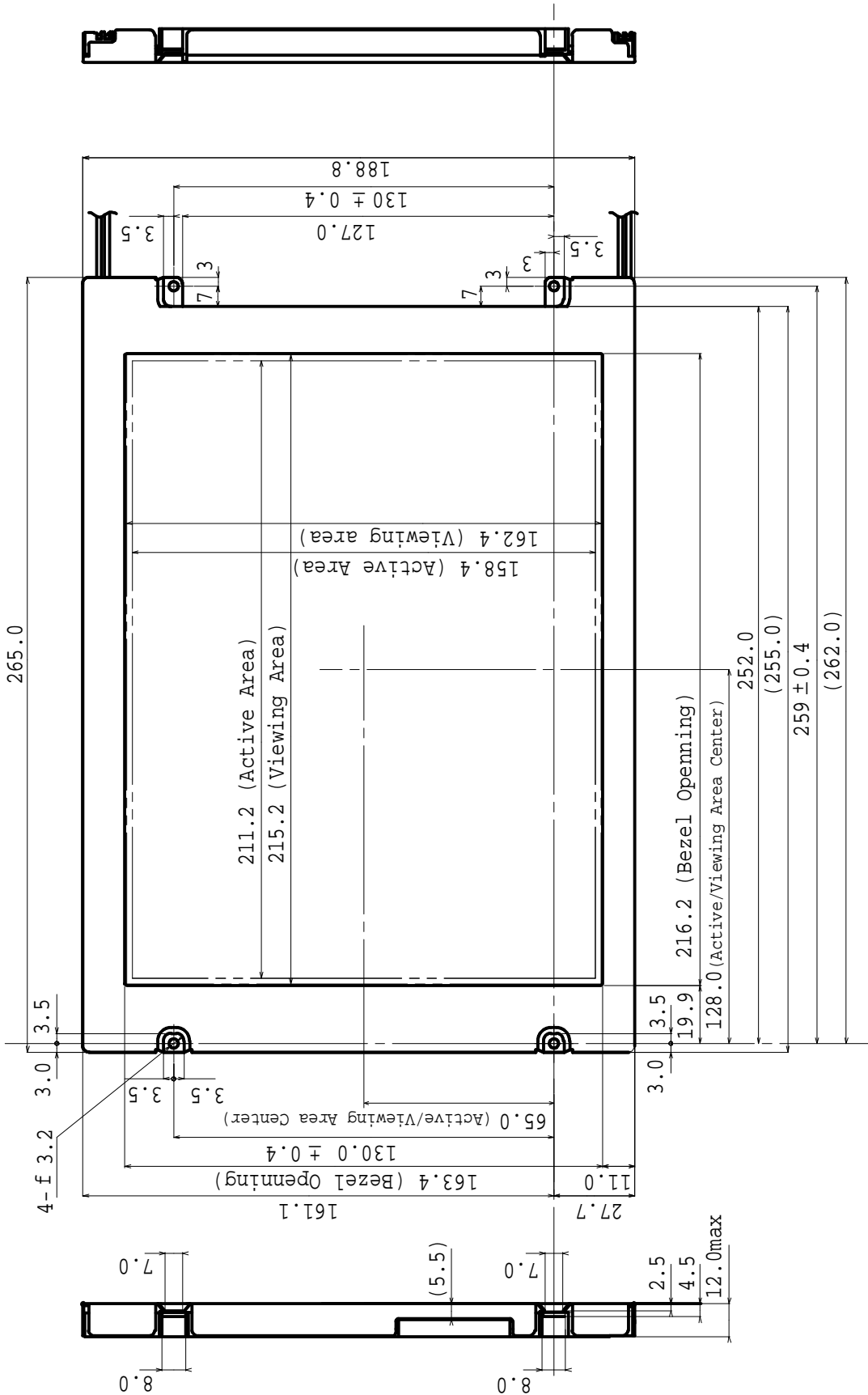

DIMENSIONAL OUTLINE

TENTATIVE

Unit : mm
Standard tolerance : 0.5

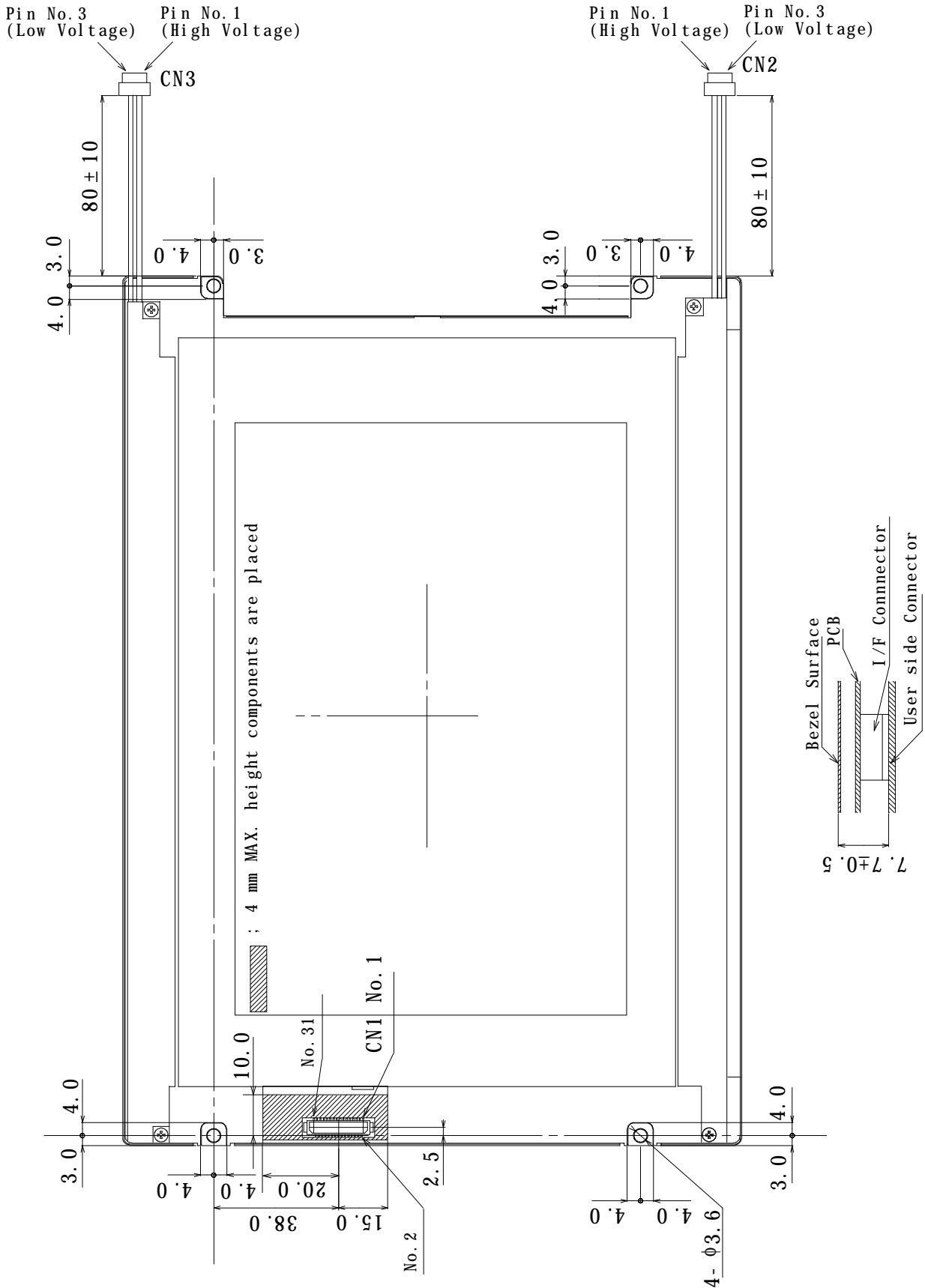

Sectional figure of I/F Connector

BLOCK DIAGRAM

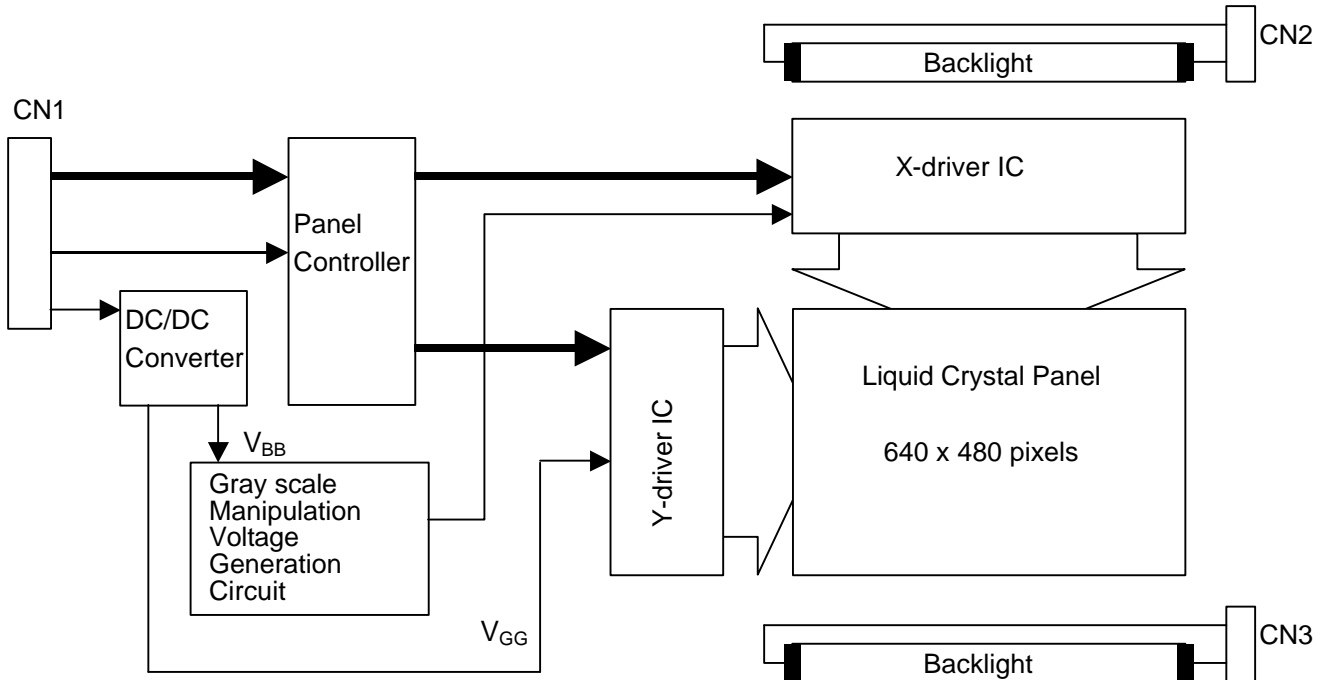

TIMING CHART

(1) Vertical Timing

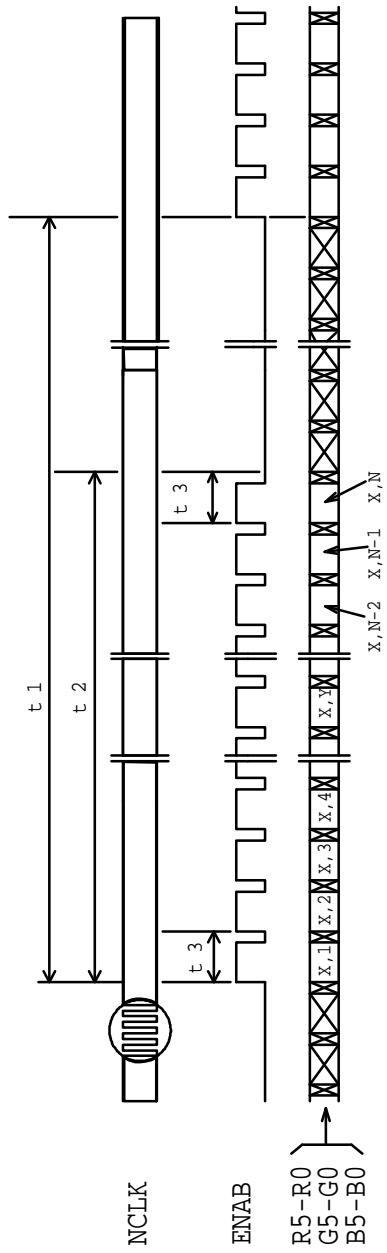

(2) Horizontal Timing

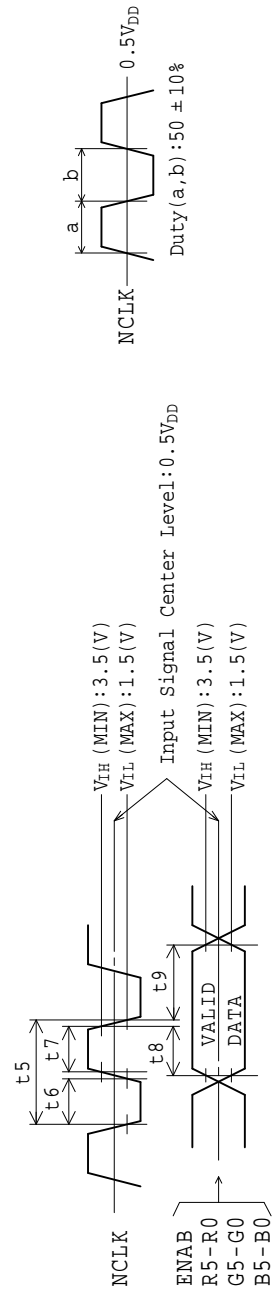
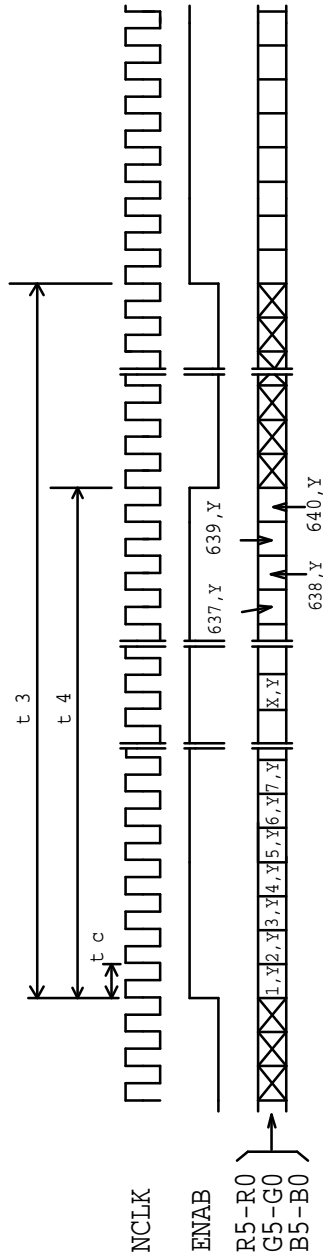

TIMING SPECIFICATION ^{1) 2) 3) 4) 5) 6)}

| Item | Symbol | Min. | Typ. | Max. | Unit | Remarks |
|-------------------------|--------|--------------------------|---------------------------|---------------------------|------|--------------------|
| Frame Period | t_1 | $249+N/2 \times t_3$ | $525 \times t_3$ 16.68 | $525 \times t_3$ 17.85 | --- | |
| Vertical Display Term | t_2 | $300 \times t_3$ | $480 \times t_3$ | $480 \times t_3$ | --- | $t_2=N \times t_3$ |
| One Line Scanning Time | t_3 | $684 \times t_c$ 31.5 | $800 \times t_c$ 31.78 | $860 \times t_c$ --- | --- | μs |
| Horizontal Display Term | t_4 | $640 \times t_c$ | $640 \times t_c$ | $640 \times t_c$ | --- | |
| Clock Period | t_c | 35.0 | 39.72 | --- | ns | |
| Clock "L" Time | t_6 | 10.0 | --- | --- | ns | |
| Clock "H" Time | t_7 | 7.0 | --- | --- | ns | |
| Set Up Time | t_8 | 5.0 | --- | --- | ns | |
| Hold Time | t_9 | 10.0 | --- | --- | ns | |

- Note 1) When ENAB is fixed to "H" level or "L" level after NCLK input, the panel is displayed as black. However, it may be occurred a flicker on the display.
- Note 2) When NCLK is fixed to "H" level or "L" level, the panel becomes white stage after several seconds.
- Note 3) Do not change t_1 and t_3 values in the operation. When t_1 or t_3 is changed, the panel is displayed as black.
- Note 4) Please adjust LCD operating signal timing and FL driving frequency, to optimize the display quality. There is a possibility that flicker is observed by the interference of LCD operating signal timing and FL driving condition (especially driving frequency).
- Note 5) When the vertical display period (N) is shorter than 480 lines, the actual display area is shifted to the center. Non-display areas become dark as follows.
- Note 5) The following conditions should be met.
- NCLK count of each Horizontal Scanning Time should be always the same.
 - V-Blanking period should be "n" x "Horizontal Scanning Time". (n=integer)
 - Frame period should be always the same.

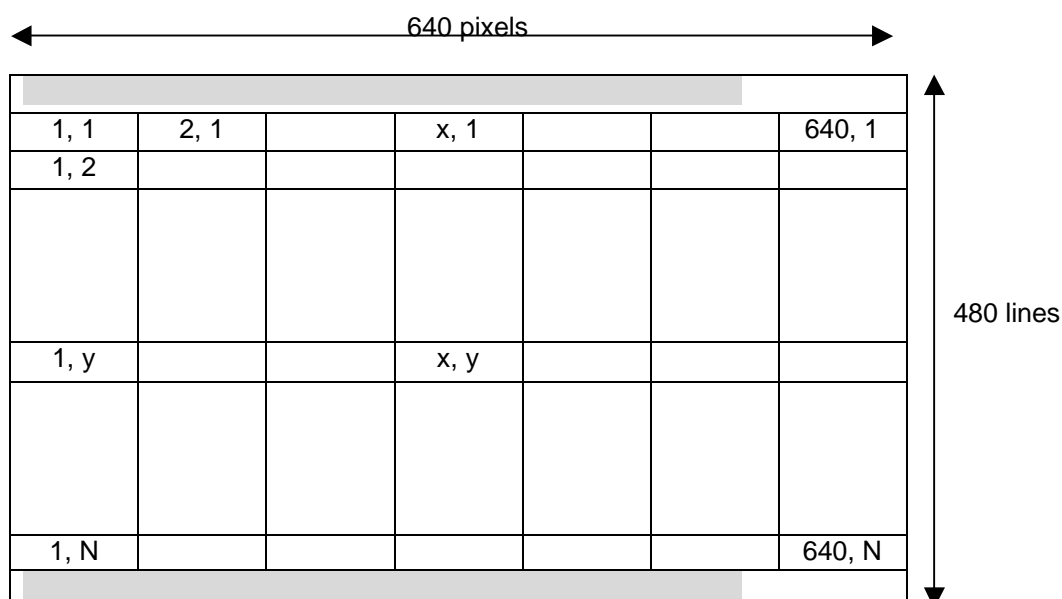

CONNECTOR PIN ASSIGNMENT FOR INTERFACE

CN1 INPUT SIGNAL

Connector : DF9B-31P-1V / HIROSE ELECTRIC CO., LTD.

Mating Connector : DF9*-31S-1V / HIROSE ELECTRIC CO., LTD. (* : option mark)

| Terminal No. | Symbol | Function |
|--------------|-----------------|---------------------------------|
| 1 | GND | |
| 2 | NCLK | SAMPLING CLOCK |
| 3 | GND | |
| 4 | R0 | RED DISPLAY DATA (LSB) |
| 5 | R1 | RED DISPLAY DATA |
| 6 | R2 | RED DISPLAY DATA |
| 7 | GND | |
| 8 | R3 | RED DISPLAY DATA |
| 9 | R4 | RED DISPLAY DATA |
| 10 | R5 | RED DISPLAY DATA (MSB) |
| 11 | GND | |
| 12 | G0 | GREEN DISPLAY DATA (LSB) |
| 13 | G1 | GREEN DISPLAY DATA |
| 14 | G2 | GREEN DISPLAY DATA |
| 15 | GND | |
| 16 | G3 | GREEN DISPLAY DATA |
| 17 | G4 | GREEN DISPLAY DATA |
| 18 | G5 | GREEN DISPLAY DATA (MSB) |
| 19 | GND | |
| 20 | ENAB | COMPOUND SYNCHRONIZATION SIGNAL |
| 21 | GND | |
| 22 | B0 | BLUE DISPLAY DATA (LSB) |
| 23 | B1 | BLUE DISPLAY DATA |
| 24 | B2 | BLUE DISPLAY DATA |
| 25 | GND | |
| 26 | B3 | BLUE DISPLAY DATA |
| 27 | B4 | BLUE DISPLAY DATA |
| 28 | B5 | BLUE DISPLAY DATA (MSB) |
| 29 | GND | |
| 30 | V _{DD} | +5V POWER SUPPLY |
| 31 | V _{DD} | +5V POWER SUPPLY |

CN2 CCFL POWER SOURCE

Connector : BHR-03VS-1 / JAPAN SOLDERLESS TERMINAL MFG CO., LTD.

Mating Connector : SM02(8.0)B-BHS-1 / JAPAN SOLDERLESS TERMINAL MFG CO., LTD.

| Terminal No. | Symbol | Function |
|--------------|-------------------|-----------------------------------|
| 1 | V _{FLH1} | CCFL Power Supply (high voltage) |
| 2 | NC ¹⁾ | Non Connection (open) |
| 3 | V _{FLL1} | CCFL Power Supply (low voltage) |

CN3 CCFL POWER SOURCE

Connector : BHR-03VS-1 / JAPAN SOLDERLESS TERMINAL MFG CO., LTD.

Mating Connector : SM02(8.0)B-BHS-1 / JAPAN SOLDERLESS TERMINAL MFG CO., LTD.

| Terminal No. | Symbol | Function |
|--------------|-------------------|-----------------------------------|
| 1 | V _{FLH2} | CCFL Power Supply (high voltage) |
| 2 | NC ¹⁾ | Non Connection (open) |
| 3 | V _{FLL2} | CCFL Power Supply (low voltage) |

Note 1) NC terminal should be open.

256k (k=1024) COLORS COMBINATION TABLE

| | Display | R5 R4 R3 R2 R1 R0 | G5 G4 G3 G2 G1 G0 | B5 B4 B3 B2 B1 B0 | Gray Scale Level |
|-----------------------------|-------------------------|-------------------|-------------------|-------------------|------------------|
| Basic Color | Black | L L L L L L | L L L L L L | L L L L L L | - |
| | Blue | L L L L L L | L L L L L L | H H H H H H | - |
| | Green | L L L L L L | H H H H H H | L L L L L L | - |
| | Light Blue | L L L L L L | H H H H H H | H H H H H H | - |
| | Red | H H H H H H | L L L L L L | L L L L L L | - |
| | Purple | H H H H H H | L L L L L L | H H H H H H | - |
| | Yellow | H H H H H H | H H H H H H | L L L L L L | - |
| | White | H H H H H H | H H H H H H | H H H H H H | - |
| Gray Scale of Red | Black | L L L L L L | L L L L L L | L L L L L L | L 0 |
| | Dark ↑ ↓ Light | L L L L L H | L L L L L L | L L L L L L | L 1 |
| | | L L L L H L | L L L L L L | L L L L L L | L 2 |
| | | : | : | : | L3... |
| | | : | : | : | L60 |
| | | H H H H L H | L L L L L L | L L L L L L | L61 |
| | H H H H H L | L L L L L L | L L L L L L | L62 | |
| | Red | H H H H H H | L L L L L L | L L L L L L | Red L63 |
| Gray Scale of Green | Black | L L L L L L | L L L L L L | L L L L L L | L 0 |
| | Dark ↑ ↓ Light | L L L L L L | L L L L L H | L L L L L L | L 1 |
| | | L L L L L L | L L L L H L | L L L L L L | L 2 |
| | | : | : | : | L3... |
| | | : | : | : | L60 |
| | | L L L L L L | H H H H L H | L L L L L L | L61 |
| | L L L L L L | H H H H H L | L L L L L L | L62 | |
| | Green | L L L L L L | H H H H H H | L L L L L L | Green L63 |
| Gray Scale of Blue | Black | L L L L L L | L L L L L L | L L L L L L | L 0 |
| | Dark ↑ ↓ Light | L L L L L L | L L L L L L | L L L L L H | L 1 |
| | | L L L L L L | L L L L L L | L L L L H L | L 2 |
| | | : | : | : | L3... |
| | | : | : | : | L60 |
| | | L L L L L L | L L L L L L | H H H H L H | L61 |
| | L L L L L L | L L L L L L | H H H H H L | L62 | |
| | Blue | L L L L L L | L L L L L L | H H H H H H | Blue L63 |
| Gray Scale of White & Black | Black | L L L L L L | L L L L L L | L L L L L L | L 0 |
| | Dark ↑ ↓ Light | L L L L L H | L L L L L H | L L L L L H | L 1 |
| | | L L L L H L | L L L L H L | L L L L H L | L 2 |
| | | : | : | : | L3... |
| | | : | : | : | L60 |
| | | H H H H L H | H H H H L H | H H H H L H | L61 |
| | H H H H H L | H H H H H L | H H H H H L | L62 | |
| | White | H H H H H H | H H H H H H | H H H H H H | White L63 |

**FOR SAFETY**

LCD module is generally designed with precise parts to achieve light weighted thin mechanical dimensions. In using our Modules, make certain that you fully understand and put into practice the warnings and safety precautions detailed in Engineering Information No.EE-N001,"CAUTIONS AND INSTRUCTIONS FOR TOSHIBA LCD MODULES". Refer to individual specifications and TECHNICAL DATA sheets (hereinafter called "TD") for more detailed technical information.

1) SPECIAL PURPOSES

A) Toshiba's Standard LCD Modules have not been customized for operation in extreme environments or for use in applications where performance failures could be life-threatening or otherwise catastrophic.

B) Since Toshiba's Standard LCD Modules have not been designed for operation in extreme environments, they must never be used in devices that will be exposed to abnormally high levels of vibration or shock which exceed Toshiba's published specification limits.

C) In addition, since Toshiba Standard LCD Modules have not been designed for use in applications where performance failures could be life-threatening or catastrophic, they must never be installed in aircraft navigation control systems (such as, but not limited to Traffic Collision Avoidance System and Air Traffic Indicator), in military defense or weapons systems, in critical industrial process-control systems (e.g., those involved in the production of nuclear energy), or in critical medical device or patient life-support systems.

2) DISASSEMBLING OR MODIFICATION

DO NOT DISASSEMBLE OR MODIFY the module. It may damage sensitive parts inside LCD module, and may cause scratches or dust on the display.

Toshiba does not warrant the module, if customer disassembled or modified it.

3) BREAKAGE OF LCD PANEL

DO NOT INGEST liquid crystal material, DO NOT INHALE this material, and DO NOT CONTACT the material with skin, if LCD panel is broken and liquid crystal material spills out.

If liquid crystal material comes into mouth or eyes, rinse mouth or eyes out with water immediately.

If this material contact with skin or cloths, wash it off immediately with alcohol and rinse thoroughly with water.

4) GLASS OF LCD PANEL

BE CAREFUL WITH CHIPS OF GLASS that may cause injuring fingers or skin, when the glass is broken.

5) ELECTRIC SHOCK

DISCONNECT POWER SUPPLY before handling LCD module.

DO NOT TOUCH the parts inside LCD module and the fluorescent lamp's connector or cables in order to prevent electric shock, because high voltage is supplied to these parts from the inverter unit while power supply is turned on.

6) ABSOLUTE MAXIMUM RATINGS AND POWER PROTECTION CIRCUIT

DO NOT EXCEED the absolute maximum rating values under the worst probable conditions caused by the supply voltage variation, input voltage variation, variation in parts' constants, environmental temperature, etc., otherwise LCD module may be damaged.

Employ protection circuit for power supply, whenever the specification or TD specifies it.

Suitable protection circuit should be applied for each system design.

7) DISPOSAL

When dispose LCD module, obey to the applicable environmental regulations.