

All information is subject to change without notice. Please read bottom notes.

FEATURES

- (1) 12.1 SVGA color display with High Luminance
- (2) Built in Long Life Lamps(MTBF:50,000 h)
(Condition/ T_a :25°C, I_{FL} :6mA(rms)(continuing lighting), f_{FL} :40kHz)
- (3) Replaceable structure of lamp units

TENTATIVE

MECHANICAL SPECIFICATIONS

Item	Specifications
Dimensional Outline (typ.)	278.3 (W) x 209.0 (H) x 14.0max (D) mm
Number of Pixels	800 (W) x 600 (H) pixels
Active Area	246.0 (W) x 184.5 (H) mm
Pixel Pitch	0.3075 (W) x 0.3075 (H)
Weight (approximately)	750g
Backlight	Twin CCFLs, Sidelight type

ABSOLUTE MAXIMUM RATINGS

Item	Min.	Max.	Unit	
Supply Voltage	(V_{DD})	-0.3	4.0	V
	(V_{FL})	0	2.0	kV(rms)
FL Driving Frequency (f_{FL})	---	100	KHz	
Input Signal Voltage (V_{IN})	-0.3	$V_{DD}+0.3$	V	
Operating Ambient Temperature ^{*1}	0	50	°C	
Operating Temperature for Panel ^{*2}	0	60	°C	
Storage Temperature	-20	60	°C	
Storage Humidity (Max. wet bulb temperature = 39°C)	10	90	%(RH)	

*1: Wet bulb temperature should be 39°C Max., and no condensation of water.

*2: The surface temperature caused by self heat radiation of cell itself is specified on this item.

ELECTRICAL SPECIFICATION ($T_a=25^\circ\text{C}$) ((RECOMMENDED OPERATION CONDITION))

Item	Min.	Typ.	Max.	Unit	Remarks	
Supply Voltage	(V_{DD})	3.0	3.3	3.6	V	
	(V_{FL})	---	630	---	V(rms)	
FL Start Voltage	1400	---	1900	V(rms)	$T_a=0^\circ\text{C}$	
High Level Input Voltage (V_{IH})	$0.8V_{DD}$	---	V_{DD}			
Low Level Input Voltage (V_{IL})	0	---	$0.2V_{DD}$	V		
Current Consumption	(I_{DD}) ^{*3}	---	280	450	mA	
	(I_{FL}) ^{*4}	3.0	---	6.5	mA(rms)	
Power Consumption ^{*1 *2}	---	8.5	---	W	$I_{FL}=6.0\text{mA(rms)}$	

*3: 8 color bars pattern

*4: Except the efficiency of FL inverter

OPTICAL SPECIFICATION ($T_a=25^\circ\text{C}$)

Item	Min.	Typ.	Max.	Unit	Remarks
Contrast Ratio (CR)	100	250	---	---	
Viewing Angle (CR ≥ 10)	(Upper+Lower)	---	100	---	°
	(Left+Right)	---	120	---	°
Response Time	(t_{ON})	---	---	50	ms
	(t_{OFF})	---	---	50	ms
Luminance (L)	200	250	---	cd/m ²	$I_{FL}=6.0\text{mA(rms)}$
Lamp Life Time (MTBF) ^{*5 *6}	50,000			h	

*5 : Conditions ; $T_a=25^\circ\text{C}$, $I_{FL}=6.0\text{mA(rms)}$, continuous lighting

*6 : Definitions of failure ; 1) Lcd luminance becomes half of the minimum value. 2) Lamp doesn't light normally.

*The information contained herein is presented only as a guide for the applications of our products. No responsibility is assumed by Toshiba Matsushita Display Technology or other rights of the third parties which may result from its use. No license is granted by implication or otherwise under any patent or patent rights of Toshiba Matsushita Display Technology or others.

*The information contained herein may be changed without prior notice. It is therefore advisable to contact Toshiba Matsushita Display Technology before proceeding with the design of equipment incorporating this product.

DIMENSIONAL OUTLINE

TENTATIVE

Unit : mm
Standard tolerance : 0.5

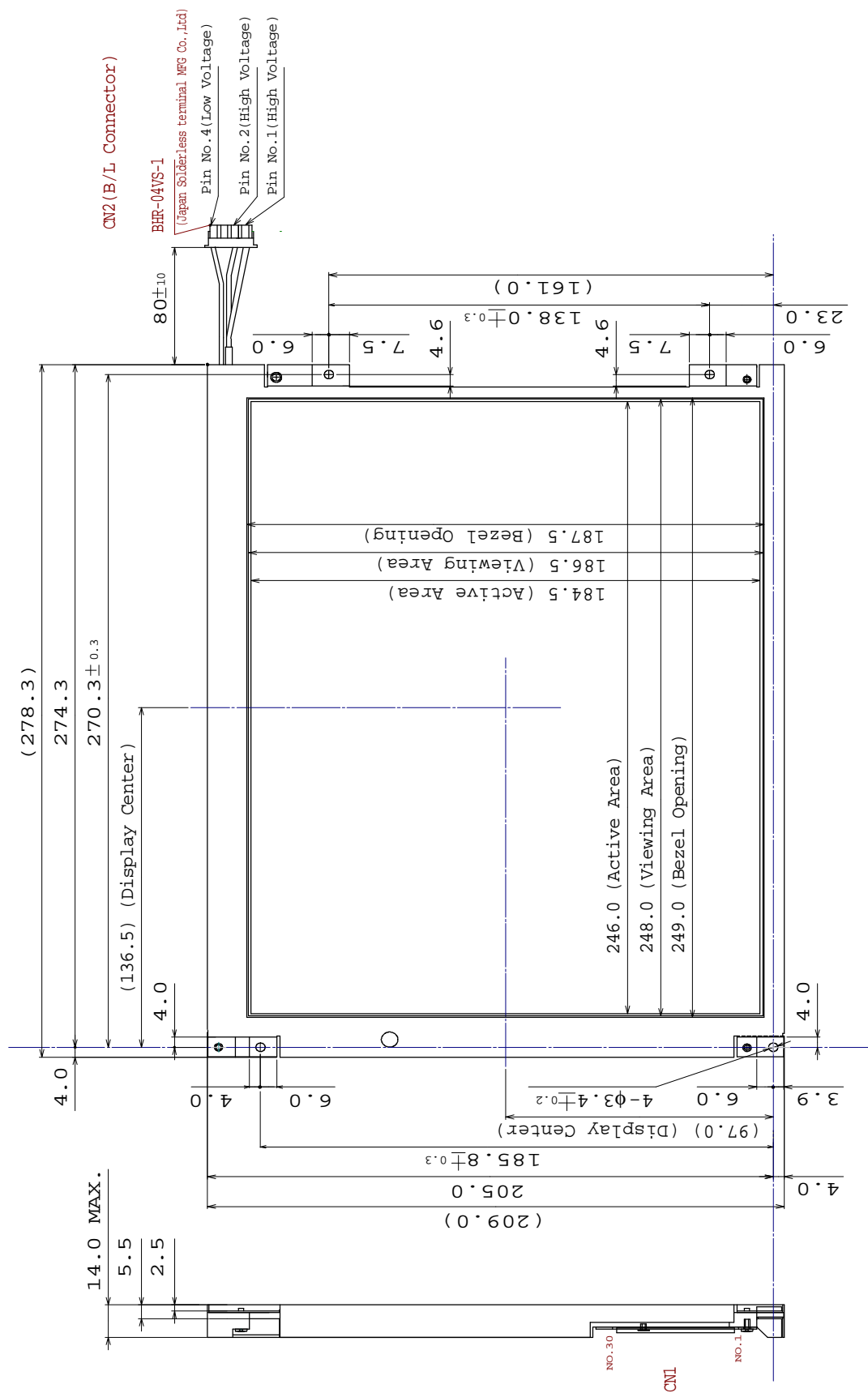

DIMENSIONAL OUTLINE

TENTATIVE

Unit : mm

Standard tolerance : 0.5

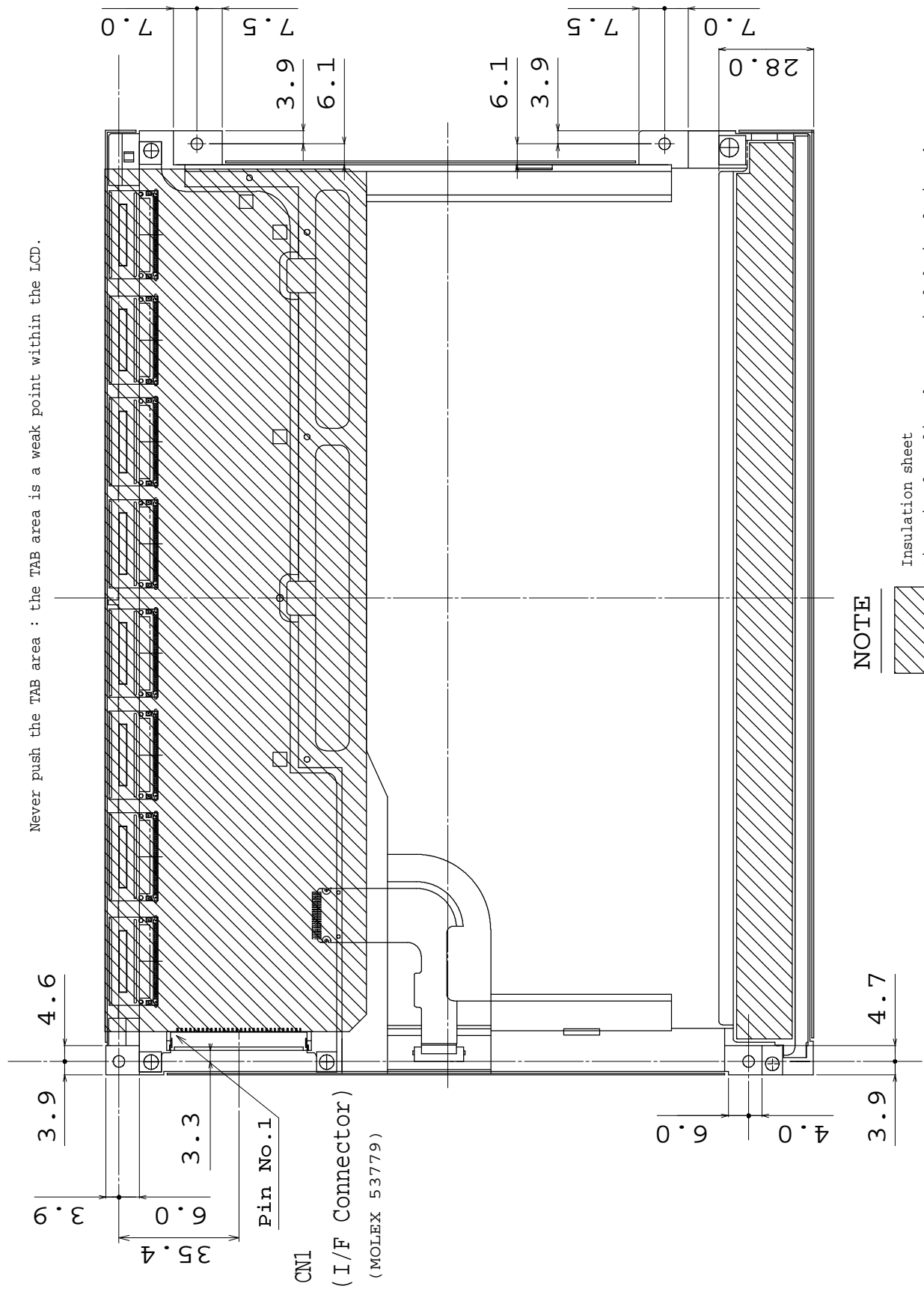

BLOCK DIAGRAM

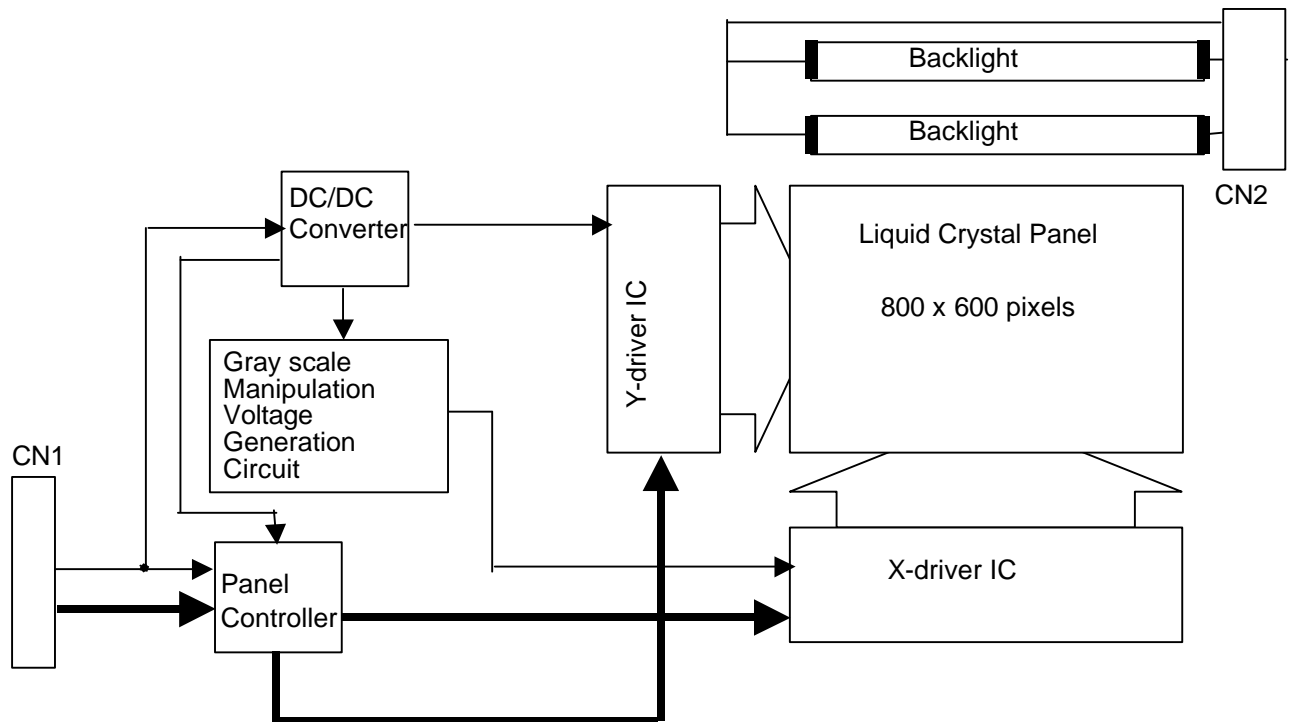

SEQUENCE OF POWER SUPPLIES AND SIGNALS

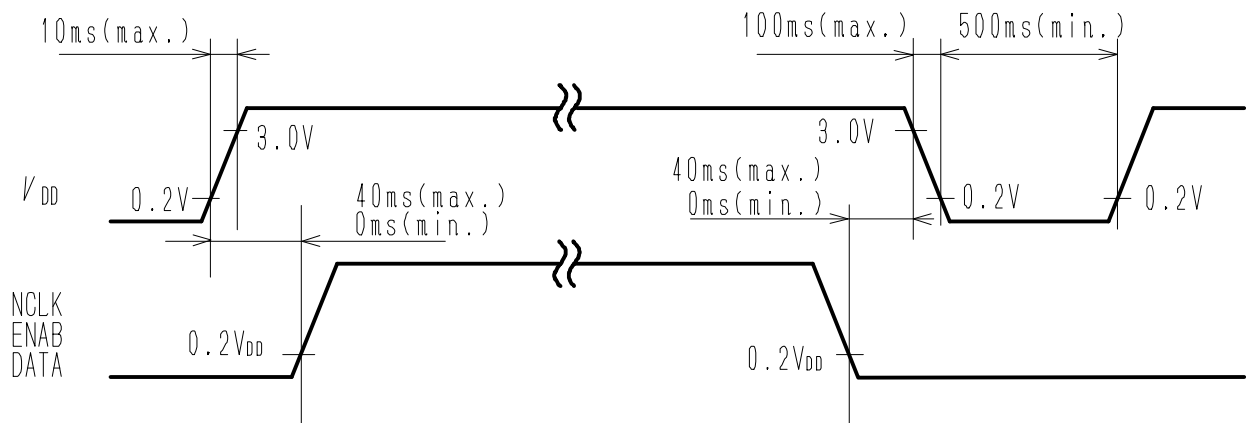

TIMING CHART

(1) Vertical Timing

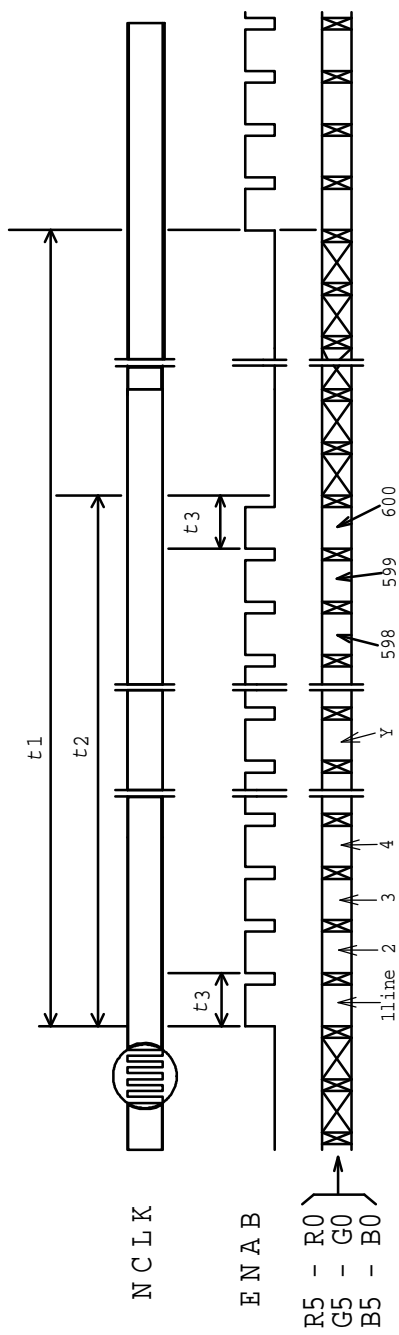

(2) Horizontal Timing

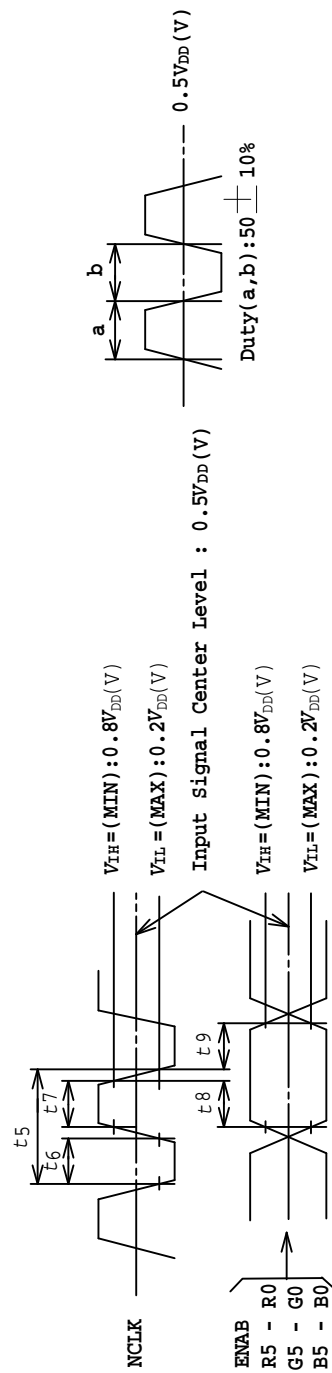
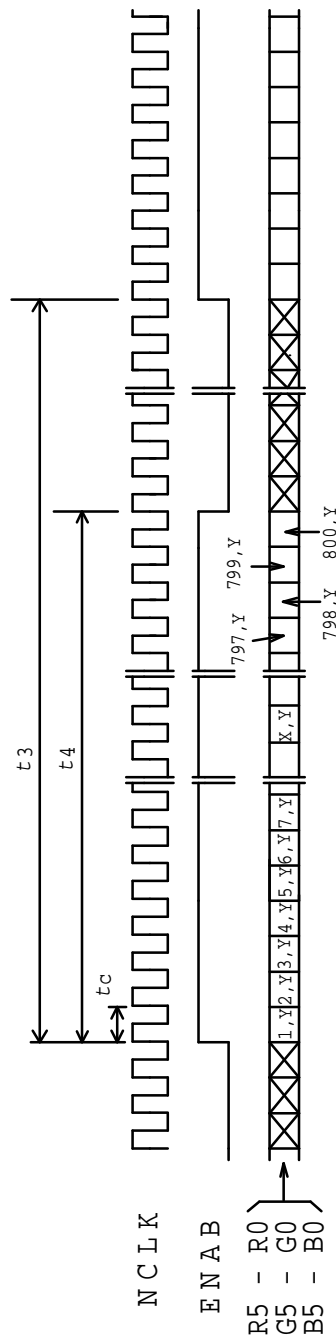

TIMING SPECIFICATION 1) 2) 3) 4) 5) 6) 7) 8) 9)

Item	Symbol	Min.	Typ.	Max.	Unit
Frame Period	t_1	604 x t_3 -	625 x t_3 17.78	628 x t_3 17.86	--- ms
Vertical Display Term	t_2	600 x t_3	600 x t_3	600 x t_3	---
One Line Scanning Time	t_3	844 x t_c 26.4	1024 x t_c 28.44	1056 x t_c ---	--- μ s
Horizontal Display Term	t_4	800 x t_c	800 x t_c	800 x t_c	---
Clock Period	t_c	25.0	27.78	---	ns
Clock "L" Time	t_6	7.0	---	---	ns
Clock "H" Time	t_7	7.0	---	---	ns
Set Up Time	t_8	3.0	---	---	ns
Hold Time	t_9	10.0	---	---	ns

- Note 1) If you operate LTM12C289 with a different timing from the above specification table, please consult with Toshiba Matsushita Display Technology before designing.
- Note 2) In case of using long the long frame period, the deterioration of display quality, noise etc., may be occurred.
- Note 3) Refer to TIMING CHART at page 5.
- Note 4) When ENAB is fixed to "H" level or "L" level after NCLK input, the panel is displayed as black. However, it may be occurred a flicker on the display.
- Note 5) Don't fix NCLK to "h" or "L" level while the VDD(+3.3V) is supplied.
If NCLK is fixed to "h" or "L" level, the normal operating signal isn't supplied to LCD panel.
This condition results the degradation of the LCD panel display quality.
- Note 6) Display area address is as follows.

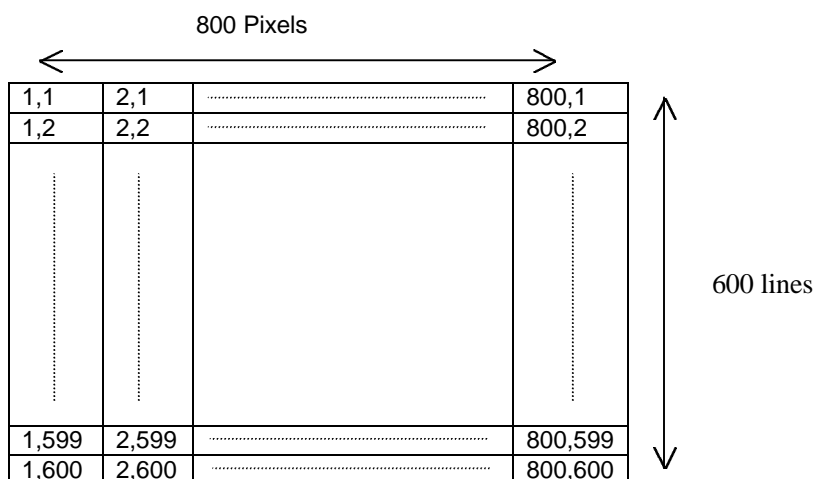

- Note 7) Please adjust LCD operating signal timing and FL driving frequency, to optimize the display quality.
There is a possibility that flicker is observed by the interference of LCD operating signal timing and FL driving condition (especially driving frequency).
- Note 8) Do not fluctuate t_1 , t_2 and t_3 , otherwise the panel is displayed as black.
- Note 9) 1. NCLK count of each Horizontal Scanning Time should be always the same.
2. V-Blanking period should be "n" x "Horizontal Scanning Time". (n : integer)
3. Frame period should be always the same.

CONNECTOR PIN ASSIGNMENT FOR INTERFACE

CN1 INPUT SIGNAL

Connector : 53779-3010 / JAPAN MOLEX CO.,LTD.

Mating Connector : 51146-3000, Contact Pin : 50641-8041

Terminal No.	Symbol	Function
1	GND	
2	NCLK	SAMPLING CLOCK
3	NC ¹⁾	
4	NC ¹⁾	
5	GND	
6	R0 ²⁾	RED DISPLAY DATA (LSB)
7	R1 ²⁾	RED DISPLAY DATA
8	R2 ²⁾	RED DISPLAY DATA
9	R3 ²⁾	RED DISPLAY DATA
10	R4 ²⁾	RED DISPLAY DATA
11	R5 ²⁾	RED DISPLAY DATA (MSB)
12	GND	
13	G0 ²⁾	GREEN DISPLAY DATA (LSB)
14	G1 ²⁾	GREEN DISPLAY DATA
15	G2 ²⁾	GREEN DISPLAY DATA
16	G3 ²⁾	GREEN DISPLAY DATA
17	G4 ²⁾	GREEN DISPLAY DATA
18	G5 ²⁾	GREEN DISPLAY DATA (MSB)
19	GND	
20	B0 ²⁾	BLUE DISPLAY DATA (LSB)
21	B1 ²⁾	BLUE DISPLAY DATA
22	B2 ²⁾	BLUE DISPLAY DATA
23	B3 ²⁾	BLUE DISPLAY DATA
24	B4 ²⁾	BLUE DISPLAY DATA
25	B5 ²⁾	BLUE DISPLAY DATA (MSB)
26	ENAB	COMPOUND SYNCHRONIZATION SIGNAL
27	GND	
28	VDD	+3.3V POWER SUPPLY
29	VDD	+3.3V POWER SUPPLY
30	GND	

CN2 CCFL POWER SOURCE

Connector : BHR-04VS-1 / JAPAN SOLDERLESS TERMINAL MFG CO., LTD.

Mating Connector³⁾ : SM04(4.0)B-BHS-1 / JAPAN SOLDERLESS TERMINAL MFG CO., LTD.

Terminal No.	Symbol	Function
1	VFLH1	CCFL Power Supply (high voltage)
2	VFLH2	CCFL Power Supply (high voltage)
3	NC ¹⁾	Non Connection (open)
4	VFLL	CCFL Power Supply (low voltage)

Note 1) NC terminal should be open.

Note 2) See next page.

Note 3) Take away terminal No.3 of the mating connector. If does not take away, it may cause smoke burn of electrical parts by high voltage.

256k (k=1024) COLORS COMBINATION TABLE

	Display	R5 R4 R3 R2 R1 R0	G5 G4 G3 G2 G1 G0	B5 B4 B3 B2 B1 B0	Gray Scale Level
Basic Color	Black	L L L L L L	L L L L L L	L L L L L L	-
	Blue	L L L L L L	L L L L L L	H H H H H H	-
	Green	L L L L L L	H H H H H H	L L L L L L	-
	Light Blue	L L L L L L	H H H H H H	H H H H H H	-
	Red	H H H H H H	L L L L L L	L L L L L L	-
	Purple	H H H H H H	L L L L L L	H H H H H H	-
	Yellow	H H H H H H	H H H H H H	L L L L L L	-
	White	H H H H H H	H H H H H H	H H H H H H	-
Gray Scale of Red	Black	L L L L L L	L L L L L L	L L L L L L	L 0
	Dark ↑ ↓ Light	L L L L L H	L L L L L L	L L L L L L	L 1
		L L L L H L	L L L L L L	L L L L L L	L 2
		:	:	:	L3...
		:	:	:	L60
		H H H H L H	L L L L L L	L L L L L L	L61
	H H H H H L	L L L L L L	L L L L L L	L62	
Red	H H H H H H	L L L L L L	L L L L L L	Red L63	
Gray Scale of Green	Black	L L L L L L	L L L L L L	L L L L L L	L 0
	Dark ↑ ↓ Light	L L L L L L	L L L L L H	L L L L L L	L 1
		L L L L L L	L L L L H L	L L L L L L	L 2
		:	:	:	L3...
		:	:	:	L60
		L L L L L L	H H H H L H	L L L L L L	L61
	L L L L L L	H H H H H L	L L L L L L	L62	
Green	L L L L L L	H H H H H H	L L L L L L	Green L63	
Gray Scale of Blue	Black	L L L L L L	L L L L L L	L L L L L L	L 0
	Dark ↑ ↓ Light	L L L L L L	L L L L L L	L L L L L H	L 1
		L L L L L L	L L L L L L	L L L L H L	L 2
		:	:	:	L3...
		:	:	:	L60
		L L L L L L	L L L L L L	H H H H L H	L61
	L L L L L L	L L L L L L	H H H H H L	L62	
Blue	L L L L L L	L L L L L L	H H H H H H	Blue L63	
Gray Scale of White & Black	Black	L L L L L L	L L L L L L	L L L L L L	L 0
	Dark ↑ ↓ Light	L L L L L H	L L L L L H	L L L L L H	L 1
		L L L L H L	L L L L H L	L L L L H L	L 2
		:	:	:	L3...
		:	:	:	L60
		H H H H L H	H H H H L H	H H H H L H	L61
	H H H H H L	H H H H H L	H H H H H L	L62	
White	H H H H H H	H H H H H H	H H H H H H	White L63	

RELIABILITY TEST

TEST CONDITIONS

- 1) The module should be driven and inspected under normal test conditions.
- 2) The module should not have condensation of water (moisture) on the module.
- 3) The module should be inspected after two or more hours storage in normal conditions (15 - 35°C, 45 - 65%(RH)).
- 4) A module shall be used only for one test.

SPECIFICATIONS

The module shall have no failure in the following reliability test items.

Test Item	Test Conditions	Result
High Temperature Operation ¹⁾	50°C 192 h	OK 3p/3p
High Temperature Storage ²⁾	60°C 192 h	OK 3p/3p
High Temperature High Humidity operation ¹⁾	50°C 80% 192 h	OK 3p/3p
Low Temperature Operation ¹⁾	0°C 192 h	OK 3p/3p
Low Temperature Storage ²⁾	-20°C 192 h	OK 3p/3p
Temperature Shock ²⁾	-20°C ⇔ 60°C 0.5h 0.5h 50 cycles	OK 3p/3p
Mechanical Vibration ²⁾	10 - 200 - 10Hz sweep/cycle, 1.5×9.8m/s ² constant, X.Y.Z each directions, 0.5h each	OK 3p/3p
Mechanical Shock ²⁾	50×9.8m/s ² , 20ms, ±X, ±Y, ±Z direction, one time each	OK 3p/3p

Note 1) Operating

Note 2) Non-Operating

Definitions of failure for judgment shall be as follows:

- 1) Function of the module should be maintained.
- 2) Current consumption should be smaller than the specified value.
- 3) Appearance and display quality should not have distinguished degradation.
- 4) Luminance should be larger than 50% of the minimum value specified in OPTICAL SPECIFICATION.

**FOR SAFETY**

LCD module is generally designed with precise parts to achieve light weighted thin mechanical dimensions. In using our Modules, make certain that you fully understand and put into practice the warnings and safety precautions detailed in Engineering Information No.EE-N001,"CAUTIONS AND INSTRUCTIONS FOR TOSHIBA LCD MODULES". Refer to individual specifications and TECHNICAL DATA sheets (hereinafter called "TD") for more detailed technical information.

1) SPECIAL PURPOSES

A) Toshiba Matsushita Display Technology's Standard LCD Modules have not been customized for operation in extreme environments or for use in applications where performance failures could be life-threatening or otherwise catastrophic.

B) Since Toshiba Matsushita Display Technology's Standard LCD Modules have not been designed for operation in extreme environments, they must never be used in devices that will be exposed to abnormally high levels of vibration or shock which exceed Toshiba Matsushita Display Technology's published specification limits.

C) In addition, since Toshiba Matsushita Display Technology Standard LCD Modules have not been designed for use in applications where performance failures could be life-threatening or catastrophic, they must never be installed in aircraft navigation control systems (such as, but not limited to Traffic Collision Avoidance System and Air Traffic Indicator), in military defense or weapons systems, in critical industrial process-control systems (e.g., those involved in the production of nuclear energy), or in critical medical device or patient life-support systems.

2) DISASSEMBLING OR MODIFICATION

DO NOT DISASSEMBLE OR MODIFY the module. It may damage sensitive parts inside LCD module, and may cause scratches or dust on the display.

Toshiba Matsushita Display Technology does not warrant the module, if customer disassembled or modified it.

3) BREAKAGE OF LCD PANEL

DO NOT INGEST liquid crystal material, DO NOT INHALE this material, and DO NOT CONTACT the material with skin, if LCD panel is broken and liquid crystal material spills out.

If liquid crystal material comes into mouth or eyes, rinse mouth or eyes out with water immediately.

If this material contact with skin or cloths, wash it off immediately with alcohol and rinse thoroughly with water.

4) GLASS OF LCD PANEL

BE CAREFUL WITH CHIPS OF GLASS that may cause injuring fingers or skin, when the glass is broken.

5) ELECTRIC SHOCK

DISCONNECT POWER SUPPLY before handling LCD module.

DO NOT TOUCH the parts inside LCD module and the fluorescent lamp's connector or cables in order to prevent electric shock, because high voltage is supplied to these parts from the inverter unit while power supply is turned on.

6) ABSOLUTE MAXIMUM RATINGS AND POWER PROTECTION CIRCUIT

DO NOT EXCEED the absolute maximum rating values under the worst probable conditions caused by the supply voltage variation, input voltage variation, variation in parts' constants, environmental temperature, etc., otherwise LCD module may be damaged.

Employ protection circuit for power supply, whenever the specification or TD specifies it.

Suitable protection circuit should be applied for each system design.

7) RECOMMENDED OPERATION CONDITIONS

The performance and quality of the LCD panel are warranted only when the LCD panel is used within "the recommended operation conditions". Toshiba Matsushita Display Technology Co., Ltd. never warrants the performance and quality of the LCD panel when you use the LCD panel over "the recommended operation conditions", although within "the absolute maximum rating".

To use the LCD panel over "the recommended operation conditions" may have bad influence on the characteristics and reliability of the LCD panel and may shorten the life of the LCD panel.

Therefore, when designing the whole set, not to be over "the recommended operation conditions", you should fully take care of supply voltage change, characteristic of connection parts, surge of input-and-output line, and surrounding temperature.

8) DISPOSAL

When dispose LCD module, obey to the applicable environmental regulations.