

To :
Date : 2005-02-17

SAMSUNG TFT-LCD
MODEL NO. : LTM170E8-L01

Approved by :

Any Modification of Spec is not allowed without SEC's permission.

Senior Manager : *Y.D. Jo* 

PREPARED BY : LCD Business Technical Customer Service Team

Samsung Electronics Co . , LTD.



Contents

Revision History	-----	(3)
General Description	-----	(4)
1. Absolute Maximum Ratings	-----	(5)
1.1 Absolute ratings of environment		
1.2 Electrical Absolute Ratings		
2. Optical Characteristics	-----	(7)
3. Electrical Characteristics	-----	(12)
3.1 TFT LCD Module		
3.2 Back-light Unit		
4. Block Diagram	-----	(16)
4.1 TFT LCD Module		
4.2 Back-light Unit		
5. Input Terminal Pin Assignment	-----	(17)
5.1 Input Signal & Power		
5.2 LVDS Interface (1)		
5.3 LVDS Interface (2)		
5.4 Back-light Unit		
5.5 Input Signals, Basic Display Colors and Gray Scale of Each Color		
6. Interface Timing	-----	(24)
6.1 Timing Parameters (DE only mode)		
6.2 Timing Diagrams of Interface Signal (DE only mode)		
6.3 Power ON/OFF Sequence		
6.4 V _{DD} Power Dip Condition		
6.5 LVDS Input Characteristics		
7. Outline Dimension	-----	(30)
8. Reliability Test	-----	(32)
9. Packing	-----	(33)
10. Marking & Others	-----	(34)
11. Inspection Criteria	-----	(36)
12. General Precaution	-----	(37)
12.1 Handling		
12.2 Storage		
12.3 Operation		
12.4 Others		

*** Revision History**

Approval

Date	Rev. No	Page	Summary
Feb. 17, 2005	E00	All	Approval specification of LTM170E8-L01 model was issued first.

*** Description**

LTM170E8-L01 is a color active matrix TFT (Thin Film Transistor) liquid crystal display (LCD) that uses amorphous silicon TFTs as switching devices. This model is composed of a TFT LCD panel, a driver circuit and a back-light system. The resolution of a 17.0" contains 1280 x 1024 pixels and can display up to 16.7 millions colors with wide viewing angles of 89° in all directions. (Vertical viewing angle : 178°, Horizontal viewing angle : 178°)

*** Features**

- High contrast ratio, high aperture structure
- PVA(Plus Viewing Angle) mode
- Wide viewing angle & High speed response
- SXGA(1280 x 1024 pixels) resolution
- Low power consumption
- 2 dual CCFTs(Cold Cathode Fluorescent Tube)
- DE (Data Enable) mode
- LVDS (Low Voltage Differential Signaling) interface (2pixel/clock)
- Compact Size Design
- Pb-free configuration

*** Applications**

Workstation & desktop monitors
 Display terminals for AV application products
 Monitors for industrial machine

* If the module is used to other applications besides the above, please contact SEC in advance.

*** General information**

Items	Specification	Unit	Note
Display area	337.92(H) x 270.336(V)	mm	
Driver element	a-Si TFT active matrix		
Display colors	16.7M	colors	
Number of pixels	1280 x 1024	pixel	
Pixel arrangement	RGB vertical stripe		
Pixel pitch	0.264(H) x 0.264(W)	mm	
Display mode	Normally Black		
Surface treatment	Haze 44% , Hard-coating (3H)		

*** Mechanical information**

Item		Min.	Typ.	Max.	Note
Module size	Horizontal(H)	354.5	354.9	355.4	mm
	Vertical(V)	289.8	290.3	290.8	mm
	Depth(D)	-	-	13.3	mm
Weight		-	-	1,700	g

1. Absolute Maximum Ratings

1.1 Absolute ratings of environment

Item	Symbol	Min.	Max.	Unit	Note
Storage temperature	T _{STG}	-20	65		(1)
Operating temperature (Glass surface temperature)	T _{OPR}	0	50		(1)
Shock (non - operating)	Snop	-	50	G	(2),(4)
Vibration (non - operating)	Vnop	-	1.5	G	(3),(4)

Note (1) Temperature and relative humidity range are shown in the figure below.

90 % RH Max. ($40\text{ }^{\circ}\text{C} \geq T_a$)

Maximum wet-bulb temperature at $39\text{ }^{\circ}\text{C}$ or less. ($T_a > 40\text{ }^{\circ}\text{C}$) No condensation.

(2) 11ms, sine wave, one time for $\pm X$, $\pm Y$, $\pm Z$ axis

(3) 10-300 Hz, Sweep rate 10min, 30min for X,Y,Z axis

(4) At vibration and shock test, the fixture which holds the module to be tested has to be hard and rigid enough so that the module would not be twisted or bent by the fixture.

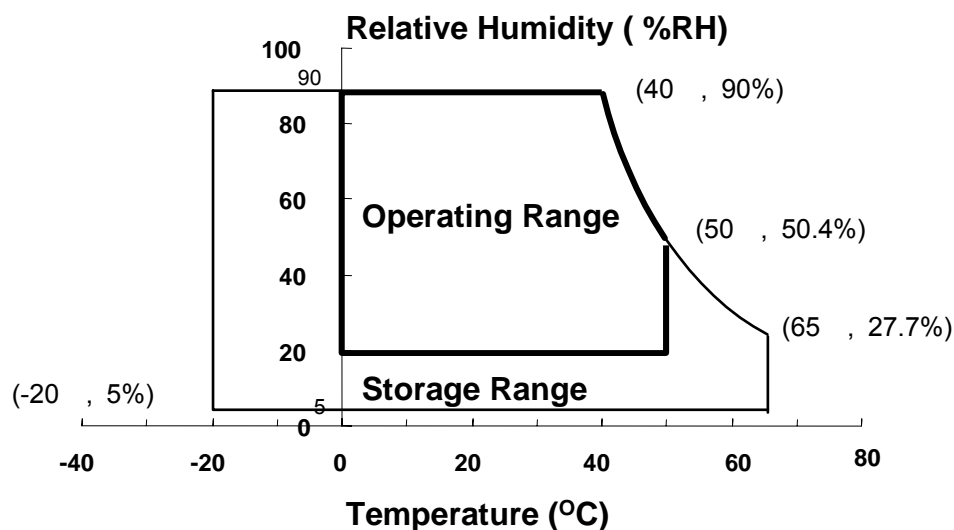

1.2 ELECTRICAL ABSOLUTE RATINGS

(1) TFT LCD Module

(V_{ss} = GND = 0 V)

Item	Symbol	Min.	Max.	Unit	Note
Power Supply Voltage	VDD	V _{ss} -0.5	6.5	V	(1)

Note (1) Within Ta (25 ± 2 °C)

(2) BACK-LIGHT UNIT

(Ta = 25 ± 2°C)

Item	Symbol	Min.	Max.	Unit.	Note
Lamp Current	IL	3.0	7.0	mArms	(1),(2)
Lamp Frequency	fL	40	80	kHz	(1)

Note (1) Permanent damage to the device may occur if maximum values are exceeded. Functional operation should be restricted to the conditions described under Normal Operating Conditions.

(2) Specified values are for a single lamp.

(Refer to the Note (1) in the page 14 for further information).

2. Optical Characteristics

Approval

The following items are measured under stable conditions. The optical characteristics should be measured in a dark room or equivalent state with the methods shown in Note (1).

Measuring equipment : TOPCON BM-5A, BM-7, PHOTO RESEARCH PR650
Eldim EZ-Contrast

(Inverter Freq. : 50kHz) * Ta = 25 ± 2°C, VDD=5V, fv= 60Hz, fdCLK=54MHz, IL = 6.5mA_{rms}

Item	Symbol	Condition	Min.	Typ.	Max.	Unit	Note
Contrast Ratio (Center of screen)	C/R		800	1500	-		(3) BM-5A
Response Time	Rising	Tr	-	15	20	msec	(5) BM-7
	Falling	Tf	-	10	15		
Luminance of White (Center of screen)	YL		240	280	-	cd/m ²	(6) BM-5A
Color Chromaticity (CIE 1931)	Red	Rx	0.610	0.640	0.670		(7) PR650
		Ry	0.300	0.330	0.360		
	Green	Gx	0.270	0.300	0.330		
		Gy	0.570	0.600	0.630		
	Blue	Bx	0.120	0.150	0.180		
		By	0.030	0.060	0.090		
	White	Wx	0.283	0.313	0.343		
		Wy	0.299	0.329	0.359		
Color Chromaticity (CIE 1976)	Red	Ru'	-	0.451	-		
		Rv'	-	0.523	-		
	Green	Gu'	-	0.125	-		
		Gv'	-	0.563	-		
	Blue	Bu'	-	0.175	-		
		Bv'	-	0.158	-		
	White	Wu'	-	0.198	-		
		Wv'	-	0.468	-		
Color Grayscale Linearity	White	Δu'v'	-	-	0.02		(9) PR650
Viewing Angle	Hor.	θ L	80	89	-	Degrees	(8) BM-5A
		θ R	80	89	-		
	Ver.	φ H	80	89	-		
		φ L	80	89	-		
	Hor.	θ L	-	75	-		
		θ R	-	75	-		
	Ver.	φ H	-	65	-		
		φ L	-	65	-		
Brightness Uniformity (9 Points)	Buni		-	-	25	%	(4) BM-5A

Note (1) Test Equipment Setup

The measurement should be executed in a stable, windless and dark room between 30min and 40min after lighting the back-light at the given temperature for stabilization of the back-light. This should be measured in the center of screen.

Single lamp current : 6.5mA (Refer to the note(1) in the page 14 for more information.)

Environment condition : $T_a = 25 \pm 2 \text{ } ^\circ\text{C}$

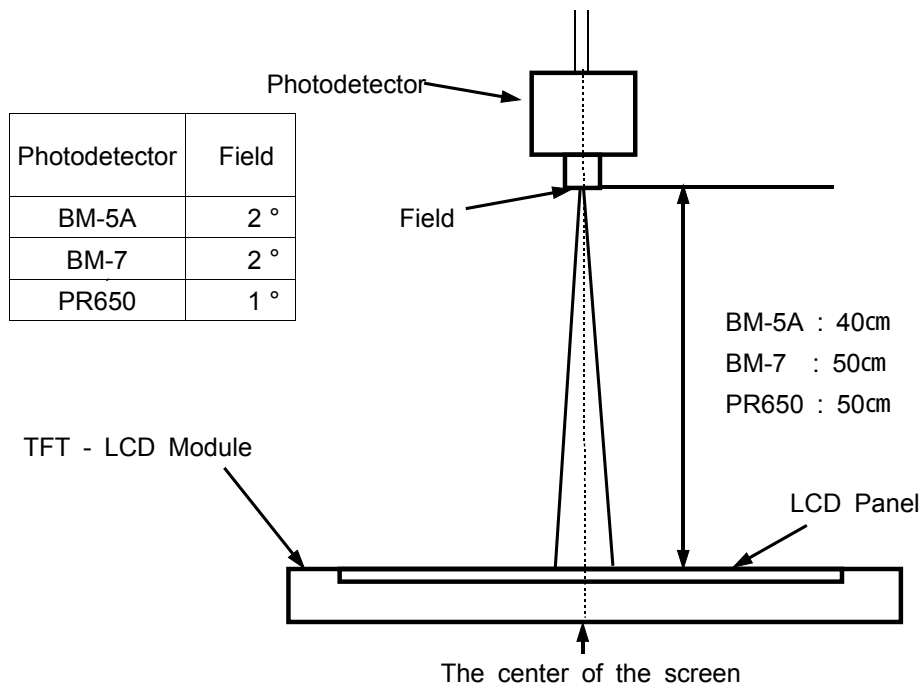

Optical Measuring Equipment Setup

Note (2) Definition of test point



Note (3) Definition of Contrast Ratio (C/R)

: Ratio of gray max (Gmax) & gray min (Gmin) at the center point of the panel

$$CR = \frac{G \text{ max}}{G \text{ min}}$$

Gmax : Luminance with all pixels white

Gmin : Luminance with all pixels black

Note (4) Definition of 9 points brightness uniformity

$$Buni = 100 * \frac{(B \text{ max} - B \text{ min})}{B \text{ max}}$$

Bmax : Maximum brightness

Bmin : Minimum brightness

Note (5) Definition of Response time : Sum of Tr, Tf

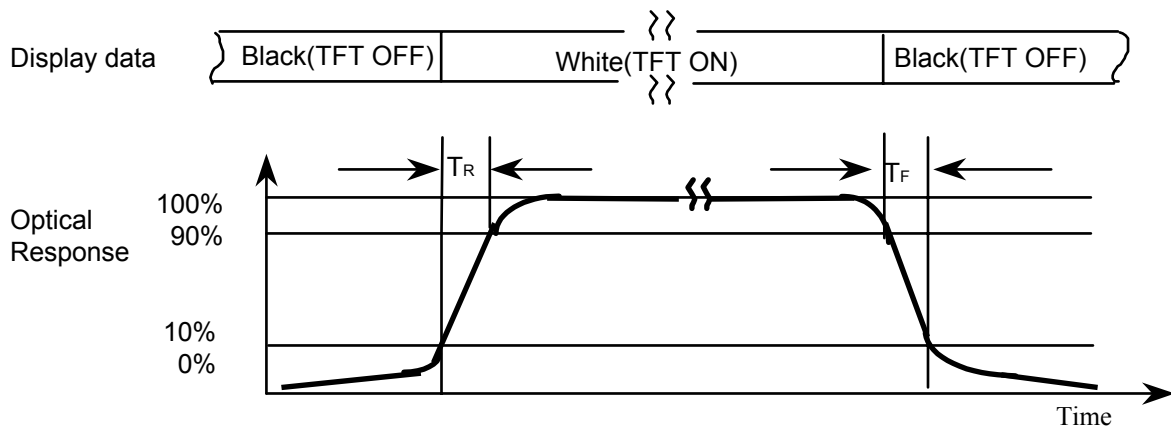

Note (6) Definition of Luminance of White : Luminance of white at center point

Note (7) Definition of Color Chromaticity (CIE 1931, CIE 1976)

Color coordinate of Red, Green, Blue & White at center point

Note (8) Definition of Viewing Angle : Viewing angle range ($CR \geq 10$, $CR \geq 100$)

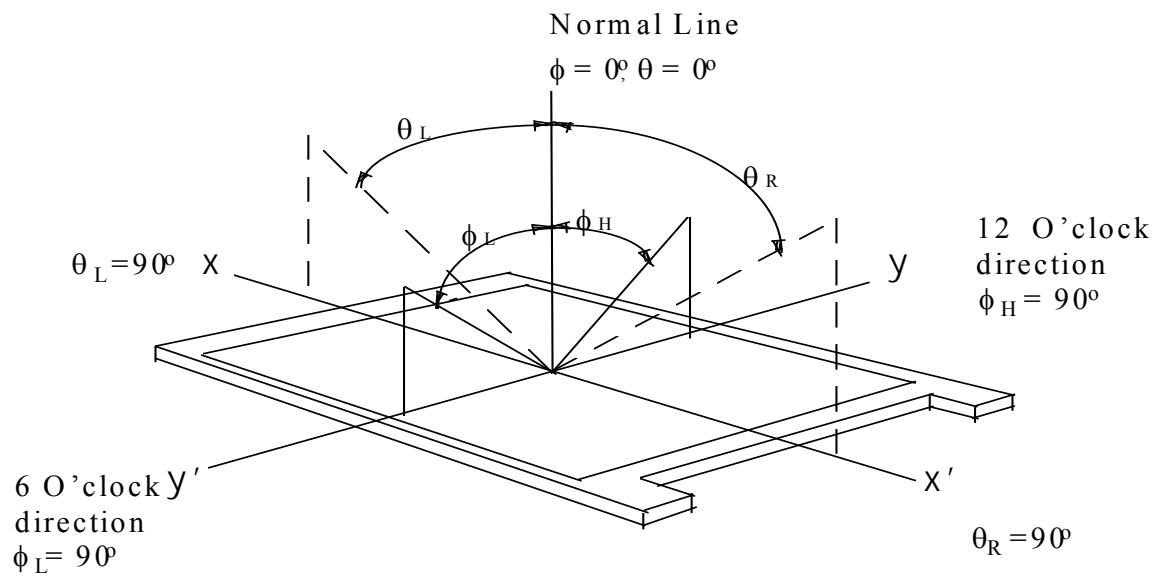

Note (9) Color Grayscale Linearity

test image : 100% full white pattern with a test pattern as below

test pattern : Squares, 40mm by 40mm in size, filled with 255, 225, 195, 165, 135 and 105 grays steps should be arranged at the center of the screen.



test method

- . 1st gray step : move a square of 255 gray level should be moved into the center of the screen and measure luminance and u' and v' coordinates.
- . next gray step : move a 225 gray square into the center and measure both luminance and coordinates, too.
- . Then, repeat the same procedure for gray steps 195, 165- 135 and 105.

test evaluation

$$\Delta u'v' = \sqrt{(u'_A - u'_B)^2 + (v'_A - v'_B)^2}$$

where A, B : 2 gray levels found to have the largest color differences between them

i.e. get the largest u' and v' of each 6 pairs of u' and v' and calculate the $u'v'$.

3. Electrical Characteristics

Approval

3.1 TFT LCD MODULE

Ta = 25°C

Item	Symbol	Min.	Typ.	Max.	Unit	Note
Voltage of Power Supply	V _{DD}	4.5	5.0	5.5	V	(1)
Interface type	LVDS	DS90C383/385/387 DS90C386 Pair				
Current of Power Supply	(a) Black	-	700	-	mA	(2),(3)
	(b) White	-	800	-	mA	
	(c) Dot	-	1000	1250	mA	
Vsync Frequency	f _V	55	60	76	Hz	
Hsync Frequency	f _H	56.7	64	81.1	kHz	
Main Frequency	f _{DCLK}	38.1	54	68.4	MHz	
Rush Current	I _{RUSH}	-	-	4.0	A	(4)

Note (1) The connector for display data & timing signal should be connected.(V_{SS}=0V)

(2) f_V=75Hz, f_{DCLK} = 67.5MHz, V_{DD} = 5.0V, DC Current.

(3) Power dissipation check pattern(LCD Module only)

a) Black Pattern

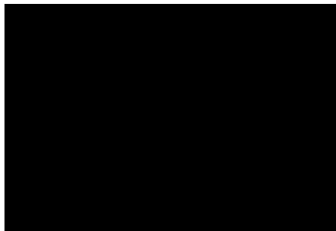

b) White Pattern



c) Dot Pattern

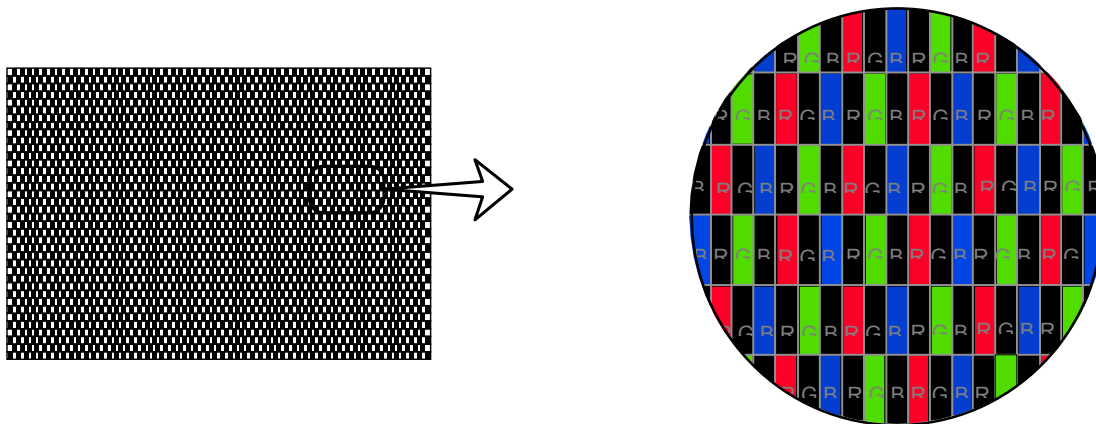

(4) Measurement Conditions

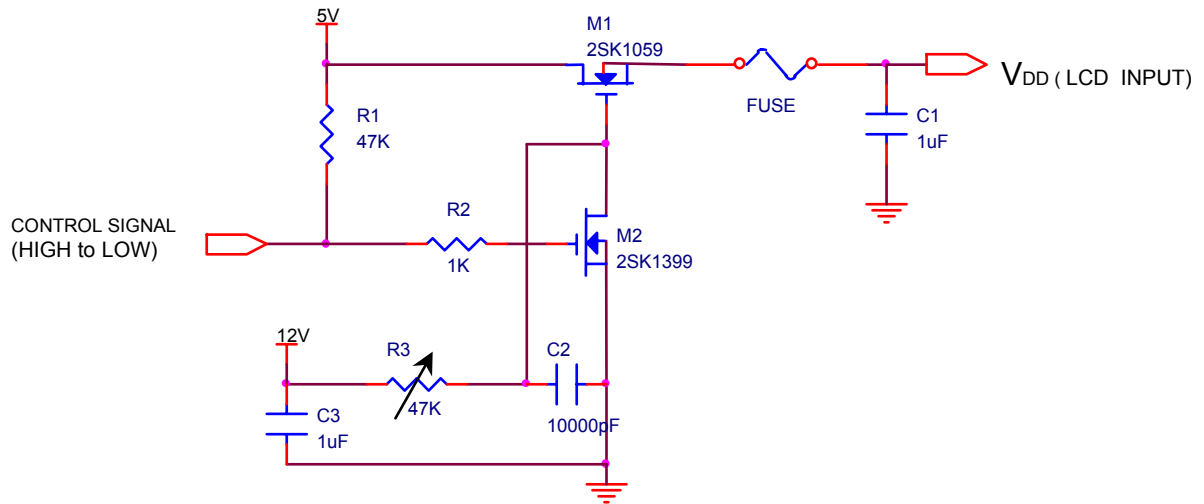

Control Signal : High(+5V) → Low(Ground)

All Signal lines to panel, except for power 5V : Ground

The rising time of supplied voltage is controlled to 470us by R3 and C2 value.

3.2 BACK-LIGHT UNIT

The back-light system is an edge - lighting type with 2 dual CCFTs (Cold Cathode Fluorescent Tube) The characteristics of two dual lamps are shown in the following tables.

$T_a = 25 \pm 2^\circ\text{C}$

Item	Symbol	Min.	Typ.	Max.	Unit	Note	
Lamp Current	IL	3.0	6.5	7.0	mArms	(1)	
Lamp Voltage	VL	-	630	-	Vrms		
Lamp Frequency	fL	40	-	60	kHz	(2)	
Operating Life Time	Hr	50,000	-	-	Hour	(3)	
inverter waveform	asymmetry rate	W_{asy}	-	-	10	%	(6)
	distortion rate	W_{dis}	-	-	2 ± 10	%	
Startup Voltage	Vs	-	-	0 : 1,580	Vrms	(4)	
				25 : 1,210			

Note) The wave form of the inverter output voltage must be area symmetric and the design of the inverter must have specifications for the modularized lamp.

The performance of the back-light, for example life time or brightness, is much influenced by the characteristics of the DC-AC inverter for the lamp. So all the parameters of an inverter should be carefully designed so as not to produce too much leakage current from high-voltage output of the inverter. When you design or order the inverter, please make sure that a poor lighting caused by the mismatch of the back-light and the inverter (poor lighting, flicker, etc.) never occur. When you confirm it, the module should be operated in the same condition as it is installed in your instrument.

Note (1) Lamp current is measured with current meter for high frequency as shown below.

Refer to the block diagram of the back-light unit in the next page for more information. Specified values are for a single lamp.

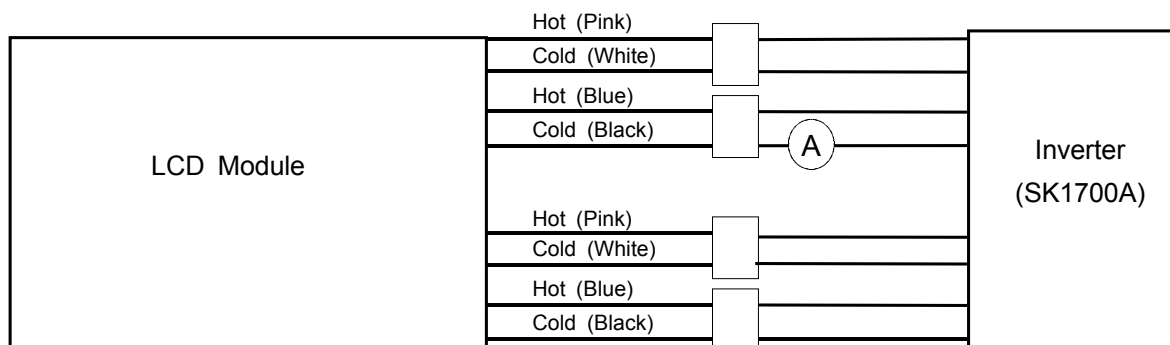

(2) Lamp frequency which may produce interference with horizontal synchronous frequency may cause line flow on the display. Therefore lamp frequency should be detached from the horizontal synchronous frequency and its harmonics as far as possible in order to avoid interference.

(3) Life time (Hr) of a lamp is defined as the time in which it continues to operate under the condition of $T_a = 25 \pm 2^\circ\text{C}$ and $I_L = 6.5\text{mArms}$ for a lamp until the brightness becomes 50% or lower than its original value. Operating condition is lamp unit itself, not module assembly at operating current 6.5mA.

- (4) If an inverter has shutdown function, it should keep its output for over 1 second even if the lamp connector is open. Otherwise the lamps may not be turned on.
- (5) Because the inverter uses high voltage, please disconnect it from the power before assembling or disassembling.
- (6) The output of the inverter must have symmetrical(negative and positive) voltage waveform and current waveform.

Please do not use the inverter which has unsymmetrical voltage and current and spike wave. Designing a system inverter intended to have better display performance, power efficiency and lamp reliability, please follow the requirements the below. They would help increase the lamp lifetime and reduce leakage current.

- The asymmetry rate of the inverter waveform should be less than 10%.
 - The distortion rate of the waveform should be within $2 \pm 10\%$.
- * Inverter output waveform had better be more similar to ideal sine wave.

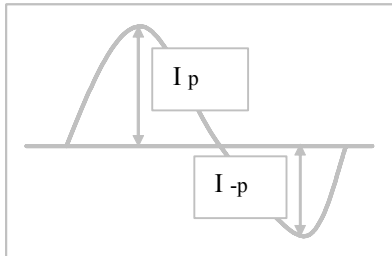

* Asymmetry rate:

$$|I_p - I_{-p}| / I_{rms} \times 100\%$$

* Distortion rate

$$I_p \text{ (or } I_{-p}) / I_{rms}$$

4. Block Diagram

4.1 TFT LCD MODULE

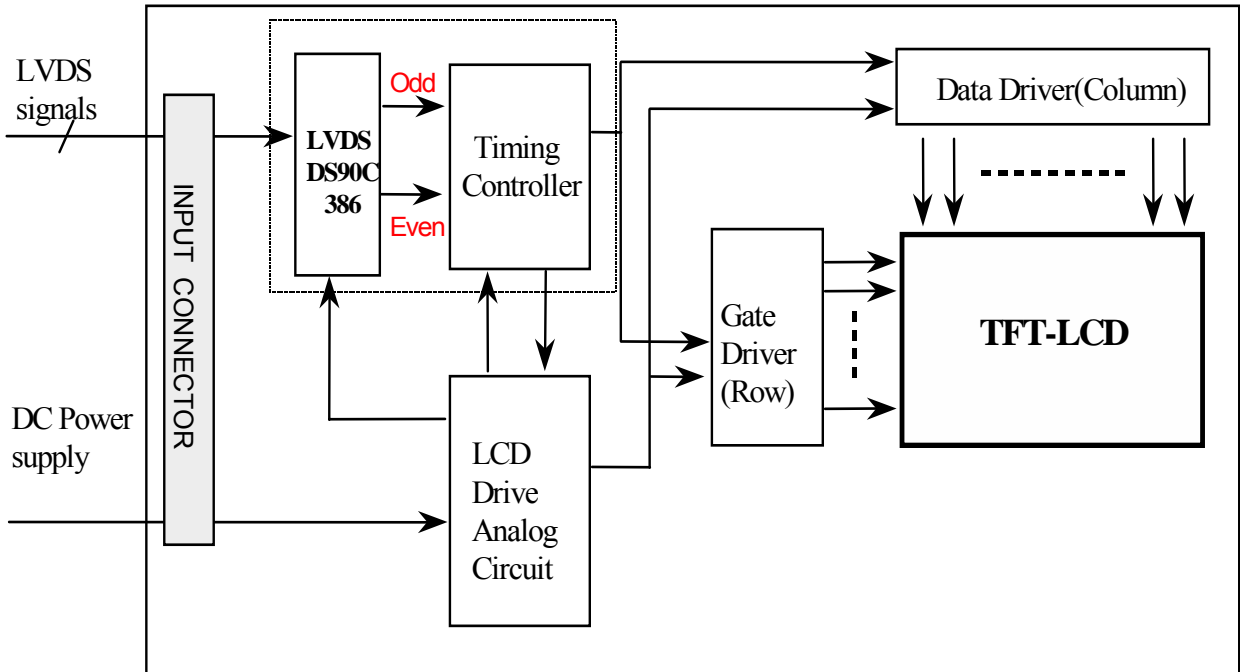

4.2 BACK-LIGHT UNIT

Connector : YEONHO 35001HS-02L or equivalent

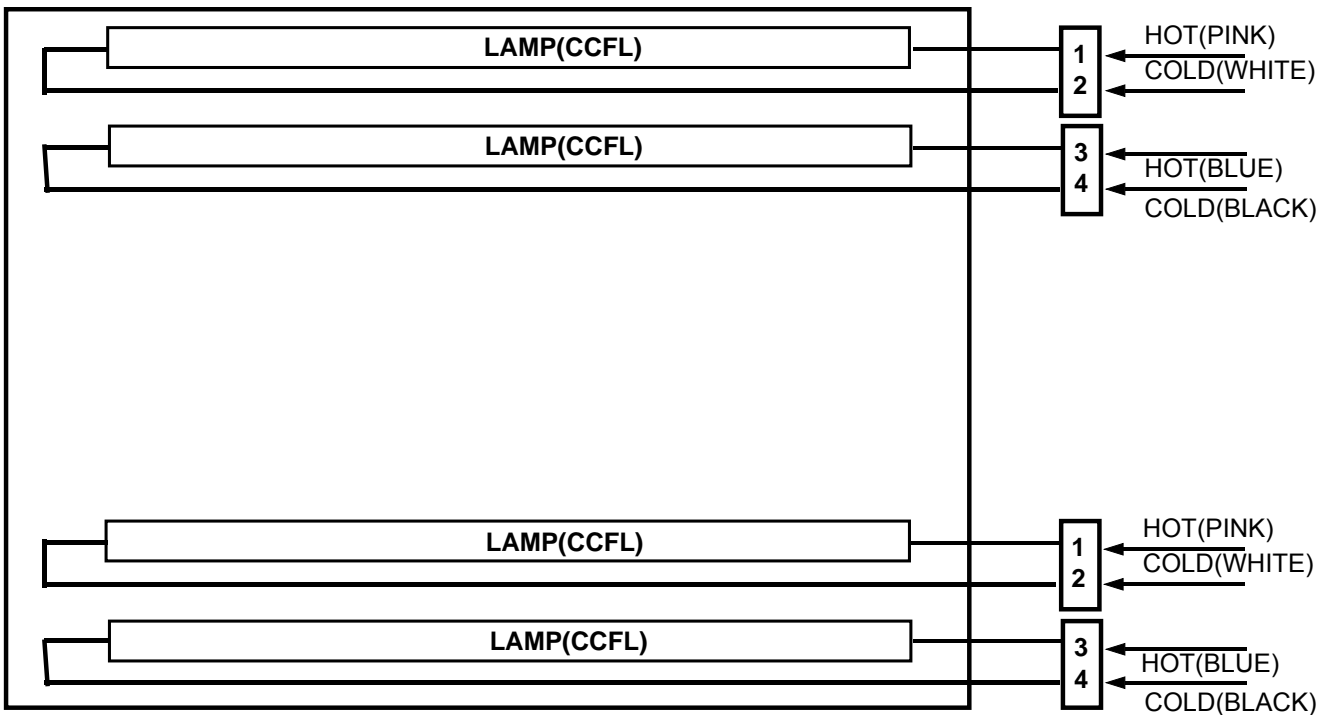

5. Input Terminal Pin Assignment

Approval

5.1. Input Signal & Power (Connector : Uju IN-30-OB100 or equivalent)

PIN NO	SYMBOL	FUNCTION
1	RX00-	Negative Transmission Data of Pixel 0 (ODD data)
2	RX00+	Positive Transmission Data of Pixel 0 (ODD data)
3	RX01-	Negative Transmission Data of Pixel 1 (ODD data)
4	RX01+	Positive Transmission Data of Pixel 1 (ODD data)
5	RX02-	Negative Transmission Data of Pixel 2 (ODD data)
6	RX02+	Positive Transmission Data of Pixel 2 (ODD data)
7	GND	Power Ground
8	RXOC-	Negative Sampling Clock (ODD data)
9	RXOC+	Positive Sampling Clock (ODD data)
10	RX03-	Negative Transmission Data of Pixel 3 (ODD data)
11	RX03+	Positive Transmission Data of Pixel 3 (ODD data)
12	RXE0-	Negative Transmission Data of Pixel 0 (EVEN data)
13	RXE0+	Positive Transmission Data of Pixel 0 (EVEN data)
14	GND	Power Ground
15	RXE1-	Negative Transmission Data of Pixel 1 (EVEN data)
16	RXE1+	Positive Transmission Data of Pixel 1 (EVEN data)
17	GND	Power Ground
18	RXE2-	Negative Transmission Data of Pixel 2 (EVEN data)
19	RXE2+	Positive Transmission Data of Pixel 2 (EVEN data)
20	RXEC-	Negative Sampling Clock (EVEN data)
21	RXEC+	Positive Sampling Clock (EVEN data)
22	RXE3-	Negative Transmission Data of Pixel 3 (EVEN data)
23	RXE3+	Positive Transmission Data of Pixel 3 (EVEN data)
24	GND	Power Ground
25	*CE	For LCD internal use only. Do not connect
26	*CTL	For LCD internal use only. Do not connect
27	NC	No connection.
28	V _{DD}	Power Supply : +5V
29		
30		

Note) Refer to page 30 for the 1st pin of interface connector marked with ▼.

* If the system already uses the 25, 26pins, it should keep under GND level.

The voltage applied to those pins should not exceed -200mV.

5.2 LVDS Interface(1)

5.2.1 Odd pixel data (1st pixel data)

1st LVDS Transmitter (<i>DS90C383</i> , <i>DS90C385</i>) Signal Interface						
Device Input Pin		Device Input Signal		Output Signal	To LTM170E8 Interface (CN101)	
No	Symbol	Symbol	Function		Terminal	Symbol
51	TXIN0	RO0	Red Odd Pixel Data (LSB)	TXOUT0- TXOUT0+	No. 1 No. 2	RXO0- RXO0+
52	TXIN1	RO1	Red Odd Pixel Data			
54	TXIN2	RO2	Red Odd Pixel Data			
55	TXIN3	RO3	Red Odd Pixel Data			
56	TXIN4	RO4	Red Odd Pixel Data			
2	TXIN5	RO7	Red Odd Pixel Data (MSB)	TXOUT3- TXOUT3+	No. 10 No. 11	RXO3- RXO3+
3	TXIN6	RO5	Red Odd Pixel Data	TXOUT0- TXOUT0+	No. 1 No. 2	RXO0- RXO0+
4	TXIN7	GO0	Green Odd Pixel Data (LSB)	TXOUT1- TXOUT1+	No. 3 No. 4	RXO1- RXO1+
6	TXIN8	GO1	Green Odd Pixel Data			
7	TXIN9	GO2	Green Odd Pixel Data			
8	TXIN10	GO6	Green Odd Pixel Data			
10	TXIN11	GO7	Green Odd Pixel Data (MSB)			
11	TXIN12	GO3	Green Odd Pixel Data	TXOUT1- TXOUT1+	No. 3 No. 4	RXO1- RXO1+
12	TXIN13	GO4	Green Odd Pixel Data			
14	TXIN14	GO5	Green Odd Pixel Data			
15	TXIN15	BO0	Blue Odd Pixel Data (LSB)	TXOUT3- TXOUT3+	No. 10 No. 11	RXO3- RXO3+
16	TXIN16	BO6	Blue Odd Pixel Data			
18	TXIN17	BO7	Blue Odd Pixel Data (MSB)			
19	TXIN18	BO1	Blue Odd Pixel Data			
20	TXIN19	BO2	Blue Odd Pixel Data			
22	TXIN20	BO3	Blue Odd Pixel Data	TXOUT2- TXOUT2+	No. 5 No. 6	RXO2- RXO2+
23	TXIN21	BO4	Blue Odd Pixel Data			
24	TXIN22	BO5	Blue Odd Pixel Data			
50	TXIN27	RO6	Red Odd Pixel Data	TXOUT3- TXOUT3+	No. 10 No. 11	RXO3- RXO3+

5.2.2 Even pixel data (2nd pixel data)

2nd LVDS Transmitter (<i>DS90C383</i> , <i>DS90C385</i>) Signal Interface						
Device Input Pin		Device Input Signal		Output Signal	To LTM170E8 Interface (CN101)	
No	Symbol	Symbol	Function		Terminal	Symbol
51	TXIN0	RE0	Red Even Pixel Data (LSB)	TXOUT0- TXOUT0+	No. 12 No. 13	RXE0- RXE0+
52	TXIN1	RE1	Red Even Pixel Data			
54	TXIN2	RE2	Red Even Pixel Data			
55	TXIN3	RE3	Red Even Pixel Data			
56	TXIN4	RE4	Red Even Pixel Data			
2	TXIN5	RE7	Red Even Pixel Data (MSB)	TXOUT3- TXOUT3+	No. 22 No. 23	RXE3- RXE3+
3	TXIN6	RE5	Red Even Pixel Data	TXOUT0- TXOUT0+	No. 12 No. 13	RXE0- RXE0+
4	TXIN7	GE0	Green Even Pixel Data (LSB)			
6	TXIN8	GE1	Green Even Pixel Data	TXOUT1- TXOUT1+	No. 15 No. 16	RXE1- RXE1+
7	TXIN9	GE2	Green Even Pixel Data			
8	TXIN10	GE6	Green Even Pixel Data	TXOUT3- TXOUT3+	No. 22 No. 23	RXE3- RXE3+
10	TXIN11	GE7	Green Even Pixel Data (MSB)			
11	TXIN12	GE3	Green Even Pixel Data	TXOUT1- TXOUT1+	No. 15 No. 16	RXE1- RXE1+
12	TXIN13	GE4	Green Even Pixel Data			
14	TXIN14	GE5	Green Even Pixel Data			
15	TXIN15	BE0	Blue Even Pixel Data (LSB)	TXOUT3- TXOUT3+	No. 22 No. 23	RXE3- RXE3+
16	TXIN16	BE6	Blue Even Pixel Data			
18	TXIN17	BE7	Blue Even Pixel Data (MSB)			
19	TXIN18	BE1	Blue Even Pixel Data	TXOUT1- TXOUT1+	No. 15 No. 16	RXE1- RXE1+
20	TXIN19	BE2	Blue Even Pixel Data	TXOUT2- TXOUT2+	No. 18 No. 19	RXE2- RXE2+
22	TXIN20	BE3	Blue Even Pixel Data			
23	TXIN21	BE4	Blue Even Pixel Data			
24	TXIN22	BE5	Blue Even Pixel Data			
50	TXIN27	RE6	Red Even Pixel Data	TXOUT3- TXOUT3+	No. 22 No. 23	RXE3- RXE3+

5.3 LVDS Interface (2)

5.3.1 Odd pixel data (1st pixel data)

LVDS Transmitter (<i>DS90C387</i>) Signal Interface						
Device Input Pin		Device Input Signal		Output Signal	To LTM170E8 Interface (CN101)	
No	Symbol	Symbol	Function		Terminal	Symbol
10	R10	RO0	Red Odd Pixel Data (LSB)	A0M A0P	No. 1 No. 2	RXO0- RXO0+
9	R11	RO1	Red Odd Pixel Data			
8	R12	RO2	Red Odd Pixel Data			
7	R13	RO3	Red Odd Pixel Data			
6	R14	RO4	Red Odd Pixel Data			
3	R17	RO7	Red Odd Pixel Data (MSB)	A3M A3P	No. 10 No. 11	RXO3- RXO3+
5	R15	RO5	Red Odd Pixel Data	A0M A0P	No. 1 No. 2	RXO0- RXO0+
2	G10	GO0	Green Odd Pixel Data (LSB)			
1	G11	GO1	Green Odd Pixel Data	A1M A1P	No. 3 No. 4	RXO1- RXO1+
100	G12	GO2	Green Odd Pixel Data			
94	G16	GO6	Green Odd Pixel Data	A3M A3P	No. 10 No. 11	RXO3- RXO3+
93	G17	GO7	Green Odd Pixel Data (MSB)			
99	G13	GO3	Green Odd Pixel Data	A1M A1P	No. 3 No. 4	RXO1- RXO1+
96	G14	GO4	Green Odd Pixel Data			
95	G15	GO5	Green Odd Pixel Data			
92	B10	BO0	Blue Odd Pixel Data (LSB)	A3M A3P	No. 10 No. 11	RXO3- RXO3+
86	B16	BO6	Blue Odd Pixel Data			
85	B17	BO7	Blue Odd Pixel Data (MSB)			
91	B11	BO1	Blue Odd Pixel Data	A1M A1P	No. 3 No. 4	RXO1- RXO1+
90	B12	BO2	Blue Odd Pixel Data	A2M A2P	No. 5 No. 6	RXO2- RXO2+
89	B13	BO3	Blue Odd Pixel Data			
88	B14	BO4	Blue Odd Pixel Data			
87	B15	BO5	Blue Odd Pixel Data			
4	R16	RO6	Red Odd Pixel Data	A3M A3P	No. 10 No. 11	RXO3- RXO3+

5.3.2 Even pixel data (2nd pixel data)

LVDS Transmitter (<i>DS90C387</i>) Signal Interface						
Device Input Pin		Device Input Signal		Output Signal	To LTM170E8 Interface (CN101)	
No	Symbol	Symbol	Function		Terminal	Symbol
84	R20	RE0	Red Even Pixel Data (LSB)	A4M A4P	No. 12 No. 13	RXE0- RXE0+
81	R21	RE1	Red Even Pixel Data			
80	R22	RE2	Red Even Pixel Data			
79	R23	RE3	Red Even Pixel Data			
78	R24	RE4	Red Even Pixel Data			
75	R27	RE7	Red Even Pixel Data (MSB)	A7M A7P	No. 22 No. 23	RXE3- RXE3+
77	R25	RE5	Red Even Pixel Data	A4M	No. 12	RXE0-
74	G20	GE0	Green Even Pixel Data (LSB)	A4P	No. 13	RXE0+
73	G21	GE1	Green Even Pixel Data	A5M	No. 15	RXE1-
72	G22	GE2	Green Even Pixel Data	A5P	No. 16	RXE1+
66	G26	GE6	Green Even Pixel Data	A7M	No. 22	RXE3-
65	G27	GE7	Green Even Pixel Data (MSB)	A7P	No. 23	RXE3+
71	G23	GE3	Green Even Pixel Data	A5M A5P	No. 15 No. 16	RXE1- RXE1+
70	G24	GE4	Green Even Pixel Data			
69	G25	GE5	Green Even Pixel Data			
64	B20	BE0	Blue Even Pixel Data (LSB)	A7M A7P	No. 22 No. 23	RXE3- RXE3+
58	B26	BE6	Blue Even Pixel Data			
57	B27	BE7	Blue Even Pixel Data (MSB)			
63	B21	BE1	Blue Even Pixel Data	A5M A5P	No. 15 No. 16	RXE1- RXE1+
62	B22	BE2	Blue Even Pixel Data	A6M A6P	No. 18 No. 19	RXE2- RXE2+
61	B23	BE3	Blue Even Pixel Data			
60	B24	BE4	Blue Even Pixel Data			
59	B25	BE5	Blue Even Pixel Data			
76	R26	RE6	Red Even Pixel Data	A7M A7P	No. 22 No. 23	RXE3- RXE3+

NOTE)

Must be connected 24th BAL pin with low and 23th DUAL pin with high in DS90C387 LVDS Transmitter

5.4 BACK-LIGHT UNIT

	Pin No.	Input	Color	Function
Upper	1	Hot1	Pink	High Voltage
	2	Cold1	White	Ground
	3	Hot2	Blue	High Voltage
	4	Cold2	Black	Ground
Lower	1	Hot1	Pink	High Voltage
	2	Cold1	White	Ground
	3	Hot2	Blue	High Voltage
	4	Cold2	Black	Ground
	Connector Part No.	YEONHO 35001HS-02L or equivalent		

5.5 Input Signals, Basic Display Colors and Gray Scale of Each Color

COLOR	DISPLAY	DATA SIGNAL																												GRAY SCALE LEVEL
		RED								GREEN								BLUE												
		R0	R1	R2	R3	R4	R5	R6	R7	G0	G1	G2	G3	G4	G5	G6	G7	B0	B1	B2	B3	B4	B5	B6	B7					
BASIC COLOR	BLACK	0	0	0	0	0	0	0	0	0	0	0	0	0	0	0	0	0	0	0	0	0	0	0	0	0	0	-		
	BLUE	0	0	0	0	0	0	0	0	0	0	0	0	0	0	0	0	1	1	1	1	1	1	1	1	1	1	-		
	GREEN	0	0	0	0	0	0	0	0	1	1	1	1	1	1	1	1	0	0	0	0	0	0	0	0	0	0	-		
	CYAN	0	0	0	0	0	0	0	0	1	1	1	1	1	1	1	1	1	1	1	1	1	1	1	1	1	1	-		
	RED	1	1	1	1	1	1	1	1	0	0	0	0	0	0	0	0	0	0	0	0	0	0	0	0	0	0	-		
	MAGENTA	1	1	1	1	1	1	1	1	0	0	0	0	0	0	0	0	1	1	1	1	1	1	1	1	1	1	-		
	YELLOW	1	1	1	1	1	1	1	1	1	1	1	1	1	1	1	1	0	0	0	0	0	0	0	0	0	0	-		
	WHITE	1	1	1	1	1	1	1	1	1	1	1	1	1	1	1	1	1	1	1	1	1	1	1	1	1	1	-		
GRAY SCALE OF RED	BLACK	0	0	0	0	0	0	0	0	0	0	0	0	0	0	0	0	0	0	0	0	0	0	0	0	0	0	R0		
	DARK	1	0	0	0	0	0	0	0	0	0	0	0	0	0	0	0	0	0	0	0	0	0	0	0	0	0	R1		
		0	1	0	0	0	0	0	0	0	0	0	0	0	0	0	0	0	0	0	0	0	0	0	0	0	0	R2		
		:	:	:	:	:	:	:	:	:	:	:	:	:	:	:	:	:	:	:	:	:	:	:	:	:	:	R3~		
		:	:	:	:	:	:	:	:	:	:	:	:	:	:	:	:	:	:	:	:	:	:	:	:	:	:	R252		
	LIGHT	1	0	1	1	1	1	1	1	0	0	0	0	0	0	0	0	0	0	0	0	0	0	0	0	0	0	R253		
		0	1	1	1	1	1	1	1	0	0	0	0	0	0	0	0	0	0	0	0	0	0	0	0	0	0	R254		
	RED	1	1	1	1	1	1	1	1	0	0	0	0	0	0	0	0	0	0	0	0	0	0	0	0	0	0	R255		
GRAY SCALE OF GREEN	BLACK	0	0	0	0	0	0	0	0	0	0	0	0	0	0	0	0	0	0	0	0	0	0	0	0	0	0	G0		
	DARK	0	0	0	0	0	0	0	0	1	0	0	0	0	0	0	0	0	0	0	0	0	0	0	0	0	0	G1		
		0	0	0	0	0	0	0	0	0	1	0	0	0	0	0	0	0	0	0	0	0	0	0	0	0	0	G2		
		:	:	:	:	:	:	:	:	:	:	:	:	:	:	:	:	:	:	:	:	:	:	:	:	:	:	G3~		
		:	:	:	:	:	:	:	:	:	:	:	:	:	:	:	:	:	:	:	:	:	:	:	:	:	:	G252		
	LIGHT	0	0	0	0	0	0	0	0	1	0	1	1	1	1	1	1	0	0	0	0	0	0	0	0	0	0	G253		
		0	0	0	0	0	0	0	0	0	1	1	1	1	1	1	1	0	0	0	0	0	0	0	0	0	0	G254		
	GREEN	0	0	0	0	0	0	0	0	1	1	1	1	1	1	1	1	0	0	0	0	0	0	0	0	0	0	G255		
GRAY SCALE OF BLUE	BLACK	0	0	0	0	0	0	0	0	0	0	0	0	0	0	0	0	0	0	0	0	0	0	0	0	0	0	B0		
	DARK	0	0	0	0	0	0	0	0	0	0	0	0	0	0	0	0	1	0	0	0	0	0	0	0	0	0	B1		
		0	0	0	0	0	0	0	0	0	0	0	0	0	0	0	0	0	1	0	0	0	0	0	0	0	0	B2		
		:	:	:	:	:	:	:	:	:	:	:	:	:	:	:	:	:	:	:	:	:	:	:	:	:	:	B3~		
		:	:	:	:	:	:	:	:	:	:	:	:	:	:	:	:	:	:	:	:	:	:	:	:	:	:	B252		
	LIGHT	0	0	0	0	0	0	0	0	0	0	0	0	0	0	0	0	1	0	1	1	1	1	1	1	1	1	B253		
		0	0	0	0	0	0	0	0	0	0	0	0	0	0	0	0	0	1	1	1	1	1	1	1	1	1	B254		
	BLUE	0	0	0	0	0	0	0	0	0	0	0	0	0	0	0	0	1	1	1	1	1	1	1	1	1	1	B255		

Note) Definition of Gray :

Rn : Red Gray, Gn : Green Gray, Bn : Blue Gray (n = Gray level)

Input Signal : 0 = Low level voltage, 1 = High level voltage

6. Interface Timing

Approval

6.1 Timing Parameters (DE only mode)

SIGNAL	ITEM	SYMBOL	MIN.	TYP.	MAX.	UNIT	NOTE
Clock	Frequency	1/TC	38.1	54	68.4	MHz	(1), (2)
	High Time	TCH	4	-	-	nsec	
	Low Time	TCL	4	-	-	nsec	
Data	Setup Time	TDS	4	-	-	nsec	
	Hold Time	TDH	4	-	-	nsec	
Data Enable	Setup Time	TES	4	-	-	nsec	
Frame Frequency	Cycle	Tv	18.2	16.7	13.1	msec	
			1032	1066	1066	lines	
	Frequency	1/Tv	55	60	76	Hz	(3)
Vertical Active Display Term	Display Period	TVD	1024	1024	1024	lines	
	Vertical Blank Period	TVB	8	-	-	lines	
One Line Scanning Time	Cycle	TH	672	-	844	clocks	
Horizontal Active Display Term	Display Period	THD	640	640	640	clocks	

Note (1) Test Point : TTL control signal and CLK at LVDS Tx input terminal in system

(2) Internal Vcc = 3.3V

(3) At low Vsync frequency, under 60Hz, flicker level can increase at specific pattern.

6.2 Timing diagrams of interface signal (DE only mode)

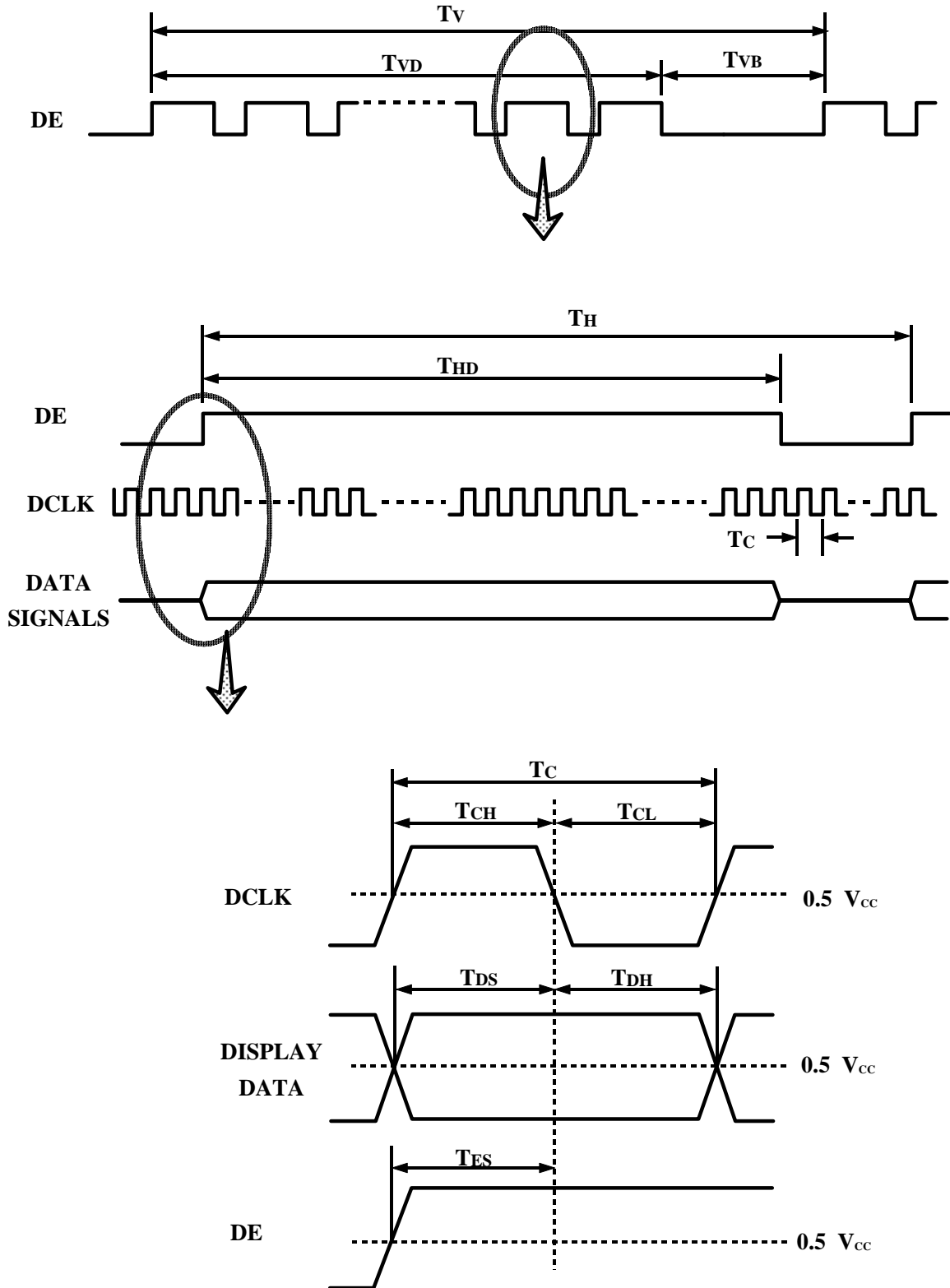

6.3 Power ON/OFF Sequence

To prevent a latch-up or DC operation of the LCD module, the power on/off sequence should be as the diagram below.

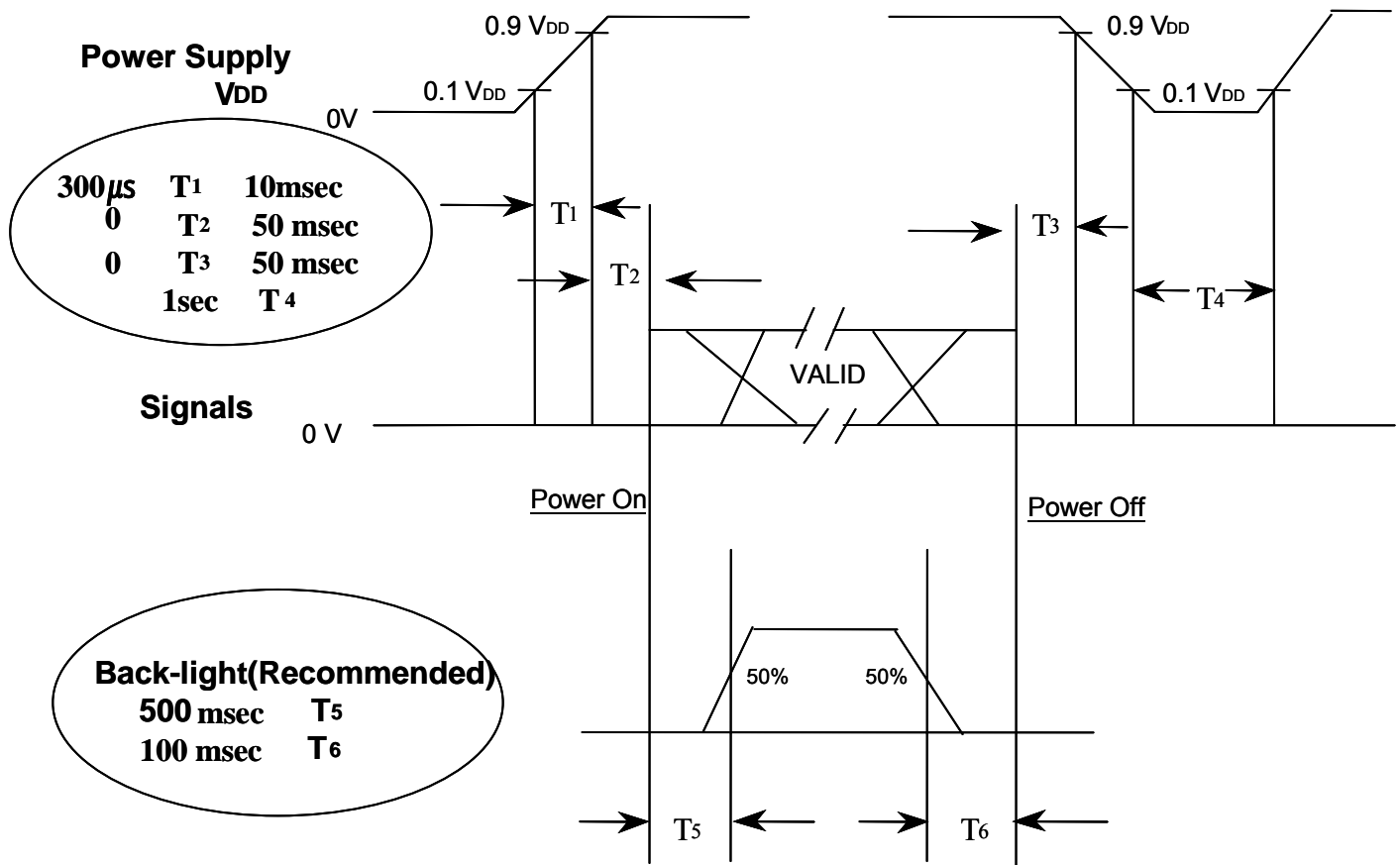

Power ON/OFF Sequence

- Note. (1) The supply voltage of the external system for the module input should be the same as the definition of V_{DD}.
- (2) Apply the lamp voltage within the LCD operation range. When the back-light turns on before the LCD operation or the LCD turns off before the back-light turns off, the display may momentarily show abnormal screen.
- (3) In case of V_{DD} = off level, please keep the level of input signals low or keep a high impedance.
- (4) T₄ should be measured after the module has been fully discharged between power off and on period.
- (5) Interface signal should not be kept at high impedance when the power is on.

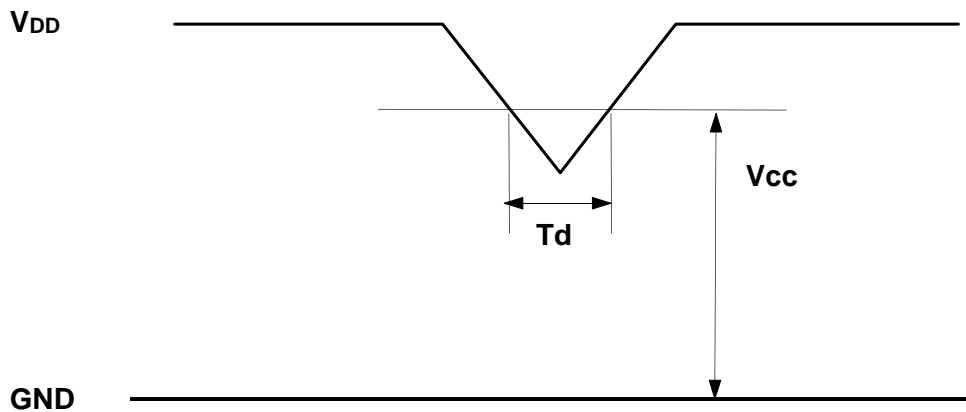
6.4 V_{DD} Power Dip Condition

<p> $4.5V < V_{DD} < 5.5V$ if $V_{DD}(typ) \times 20\%$ $V_{cc} < V_{DD}(typ) \times 10\%$, then, $0 < T_d < 20msec$ </p>
--

NOTE

- (1) The above conditions are for the glitch of the input voltage.
- (2) For stable operation of an LCD module power, please follow them.
 i.e., if $typ V_{DD} \times 20\%$ $V_{cc} < typ V_{DD} \times 10\%$,
 then T_d should be less than 20ms.

6.5 LVDS Input Characteristics

6.5.1 LVDS Receiver input

Symbol	Parameter	Conditions	Min	Typ	Max	unit	Note
V_{TH}	LVDS input high threshold	$V_{CMLVDS} = 1.25V$			+100	mV	
V_{TL}	LVDS input low threshold		-100			mV	
V_{CMLVDS}	LVDS input common mode voltage		1.125	1.25	1.375	V	
I_{IN}	Input current	$V_{IN}=2.4V/0V$ $V_{DD}=3.6V$	-10		+10	μA	
t_{skew}	skew between LVDS clock & LVDS data		-200	0	200	psec	(1)

Note (1) LVDS skew

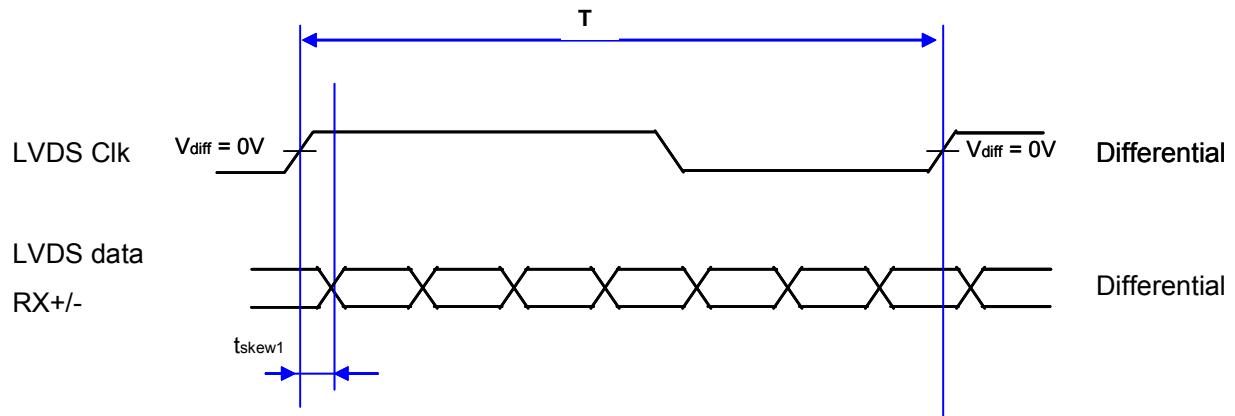

where t_{skew} : skew between LVDS clock & LVDS data,

T : 1 period time of LVDS clock

cf) (-/+) of 200psec means LVDS data goes before or after LVDS clock.

6.5.2 RSDS Output

Symbol	Parameter	Conditions	Min	Typ	Max	unit
V_{OHDF}	Output differential high voltage	$R_L = 100$ $P_{II} = 13K$	150	170	200	mV
V_{OLDF}	Output differential low voltage		-200	170	150	mV
V_{CM}	RSDS output common voltage		1.0	1.2	1.4	V
R_L	RSDS output load impedance		50	100	110	

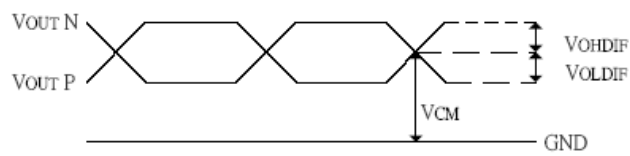

7. Outline Dimension

[Refer to the next page]

Approval

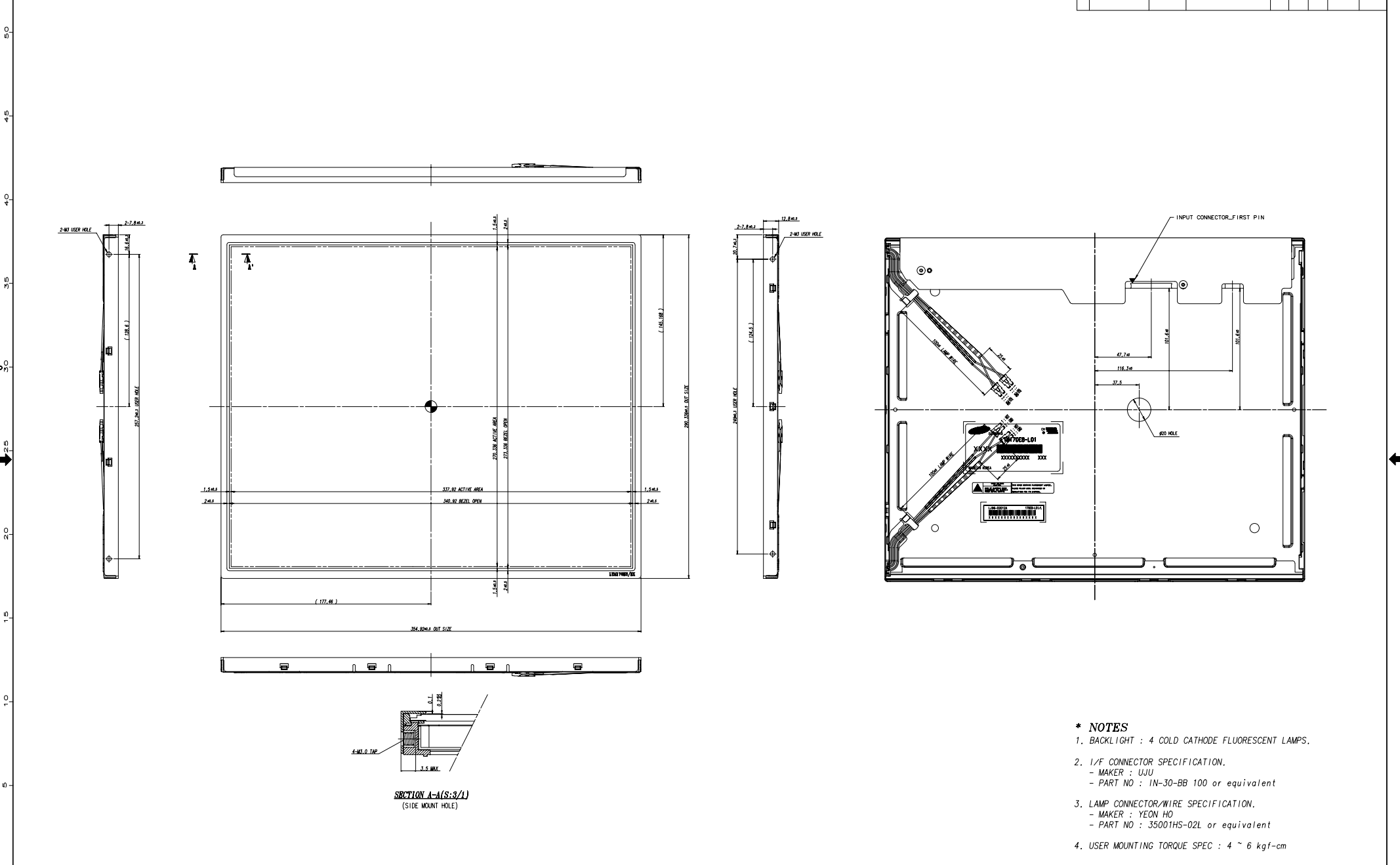

- * NOTES**
1. BACKLIGHT : 4 COLD CATHODE FLUORESCENT LAMPS.
 2. I/F CONNECTOR SPECIFICATION.
 - MAKER : UJU
 - PART NO : IN-30-BB 100 or equivalent
 3. LAMP CONNECTOR/WIRE SPECIFICATION.
 - MAKER : YEON HO
 - PART NO : 35001HS-02L or equivalent
 4. USER MOUNTING TORQUE SPEC : 4 ~ 6 kgf-cm

REVISION	GENERAL TOLERANCE				REV	DATE	DESCRIPTION OF REVISION			REASON	CHK'D BY	
	STEP	LEVEL 1	LEVEL 2	LEVEL 3	UNIT	mm	DRAW'N BY	DES'D BY	CHK'D BY	APP'D BY	MODEL NAME	
	0 < X ≤ 4	±0.05	±0.1	±0.2	SCALE	N/S	J.M.SBO	S.W.LEE	J.G.LEE			LTM170E8-L01-L
	4 < X ≤ 16	±0.08	±0.15	±0.3	TOLERANCE							PART/SHEET NAME: OUTLINE DIM. SHEET 1/1
16 < X ≤ 64	±0.12	±0.25	±0.5									
64 < X ≤ 256	±0.25	±0.4	±0.8			SAMSUNG ELECTRONICS			SPEC. NO	CODE NO.	VER. 00	

8. Reliability Test

Approval

Test Items	Conditions	Time/Cycle	Sample	
HTOL*	50°C , Bias	500 hrs	12	
LTOL*	0°C , Bias	500 hrs	5	
THB**	40°C / 95% , Bias	500 hrs	5	
HTS***	70°C , No Bias	500 hrs	5	
LTS***	-30°C , No Bias	500 hrs	5	
Thermal Cycle	-20°C/30min ~ +60°C/30min , No bias	100 cycle	5	
Box Drop	1 angle , 3 edge , 6 side , 66 cm		5	
Shock (Non-operating)	50G , 11msec Sine wave , ± x/y/z axis	1 time/axis	3	
Vibration (Non-operating)	1.5G , 10~300 Hz ±x/y/z axis , sweep rate : 10 min	30min/axis	3	
ESD	Operating	contact : 150pF, 330Ω, 100points, once/point	± 8kV	3
		Air(non-contact) : 150pF, 330Ω, 100points, once/point	± 15kV	3
	Non-operating	CDM : 150pF , 330Ω, 9points, 3times/point	± 10kV	3

[Result Evaluation Criteria]

Under the display quality test conditions with normal operation state, these should be no change which may affect practical display functions.

* HTOL/ LTOL : High/Low Temperature Operating Life,

** THB : Temperature Humidity Bias

*** HTS/LTS : High/Low Temperature Storage

9. PACKING

Approval

9.1 CARTON (Internal Package)

(1) Packing Form

Corrugated fiberboard box and EPS cushion as shock absorber

(2) Packing Method

a) Without Inverter

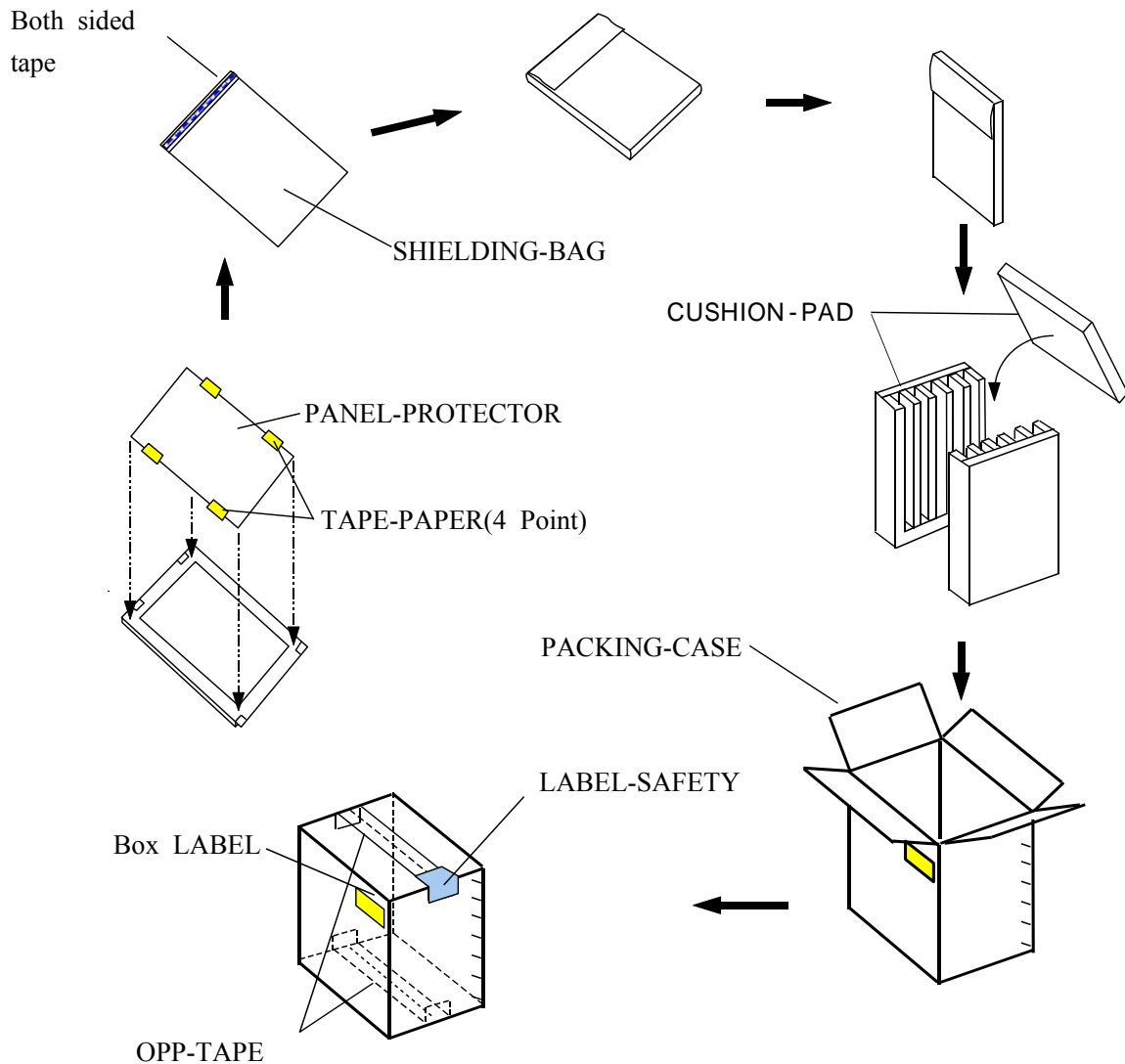

NOTE) 1) TOTAL : Approx. 10kg

2) Acceptance number of piling : 5sets

3) Carton size : 390(W) X 320(D) X 470(H)

4) MAX accumulation quantity : 5 cartons

(3) Packing Material

No	Part name	Quality
1	Static electric protective sack	5
2	Packing case(Inner box) included shock absorber	1 set
3	Pictorial marking	2 pics
4	Carton	1 set

10. MARKING & OTHERS

A nameplate bearing followed by is affixed to a shipped product at the specified location on each product.

- (1) Parts number : LTM170E8-L01-XXX
- (2) Revision code : Two letters
- (3) Customer code : One letter

X XX

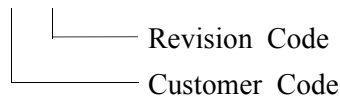

- (4) Lot number : 6 Q 4 D 00111C

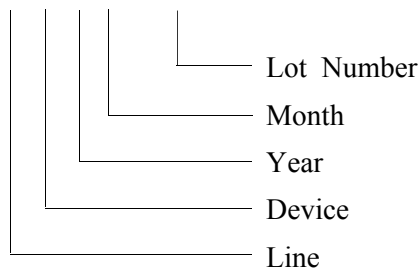

(5) Nameplate Indication

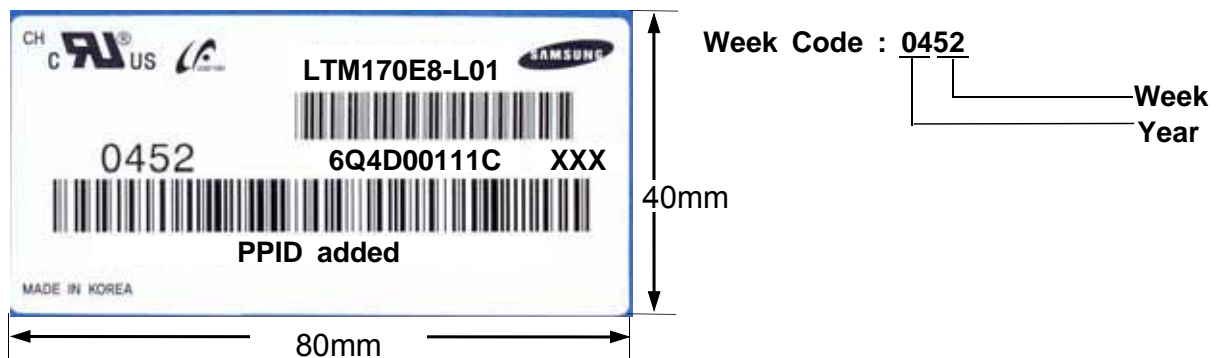

(6) Packing box attach

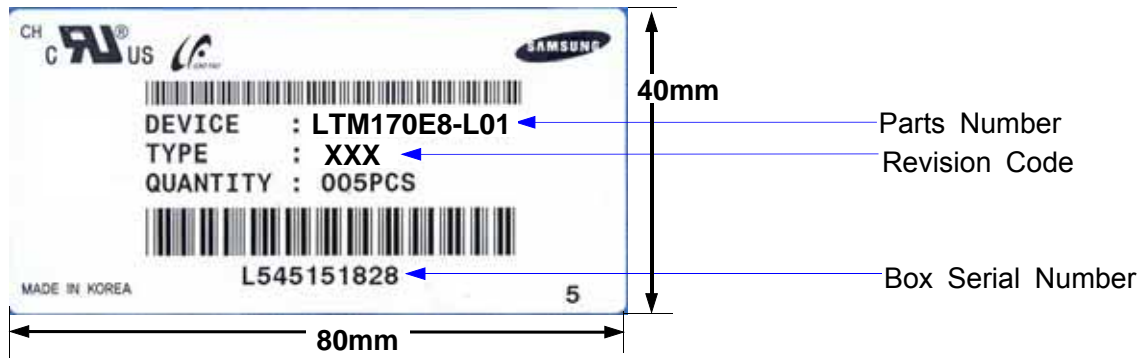

(7) Others

1. After service part : None

(Lamps cannot be replaced because of the narrow bezel structure.)

When products are shipped, incoming inspection should be carried out with a sampling inspection based on MIL-STD-105E level II by AQL 1.0%.

CHANGE CONTROL

Design of the product may be changed regarding the specifications, appearance, parts used, circuits, etc. for product improvement.

If a design change is judged to affect the specifications of this product, supplier should inform customer of the change in advance.

QUALITY CONTROL

In the event of a product failure under normal operating conditions, a product trouble or a functional disorder that can be deemed to be the responsibility of supplier, supplier should repair the fault or replace the product free of charge within one year from the product delivery date. However, supplier does not take responsibility for the product quality in the case of modifications not specified by supplier.

MAINTENANCE

The specifications of the functions of maintenance parts may be partially changed within the range which provides equivalent or better quality.

In principle, maintenance parts should be product units.

When stopping manufacturing this product, supplier should notify customer in advance.

HANDLING OF DOUBTFUL POINTS

Any doubt not stipulated in this specification is to be resolved by mutual agreement between customer and supplier, and supplier should make efforts for improvement in good faith.

12.1 Handling

- (a) When the module is assembled, it should be attached to the system firmly using all mounting holes. Be careful not to twist and bend the module.
- (b) Because the inverter use high voltage, it should be disconnected from power before it is assembled or disassembled.
- (c) Refrain from strong mechanical shock and / or any force to the module. In addition to damage, this may cause improper operation or damage to the module and CCFT back-light.
- (d) Note that polarizers are very fragile and could be damage deasily. Do not press or scratch the surface harder than a HB pencil lead.
- (e) Wipe off water droplets or oil immediately. If you leave the droplets for a long time, staining or discoloration may occur.
- (f) If the surface of the polarizer is dirty, clean it using some absorbent cotton or soft cloth.
- (g) Desirable cleaners are water, IPA(Isopropyl Alcohol) or Hexane. Do not use Ketone type materials(ex. Acetone), Ethyl alcohol, Toluene, Ethyl acid or Methyl chloride. It might permanent damage to the polarizer due to chemical reaction.
- (h) If the liquid crystal material leaks from the panel, it should be kept away from the eyes or mouth . In case of contact with hands, legs or clothes, it must be washed away with soap thoroughly.
- (i) Protect the module from static, or the CMOS Gate Array IC would be damaged.
- (j) Use finger-stalls with soft gloves in order to keep display clean during the incoming inspection and assembly process.
- (k) Do not disassemble the module.
- (l) Do not pull or fold the lamp wire.
- (m) Do not adjust the variable resistor located on the module.
- (n) Protection film for polarizer on the module should be slowly peeled off just before use so that the electrostatic charge can be minimized.
- (o) Pins of I/F connector should not be touched directly with bare hands.

12.2 Storage

- (a) Do not leave the module in high temperature, and high humidity for a long time. It is highly recommended to store the module with temperature from 0 to 35 and relative humidity of less than 70%.
- (b) Do not store the TFT-LCD module in direct sunlight.
- (c) The module should be stored in a dark place. It is prohibited to apply sunlight or fluorescent light in storing.

12.3 Operation

- (a) Do not connect or disconnect the module in the "Power On" condition.
- (b) Power supply should always be turned on/off by the item 6.3 "Power on/off sequence"
- (c) Module has high frequency circuits. Sufficient suppression to the electromagnetic interference should be done by system manufacturers. Grounding and shielding methods may be important to minimize the interference.
- (d) The cable between the back-light connector and its inverter power supply should be connected directly with a minimized length. A longer cable between the back-light and the inverter may cause lower luminance of lamp(CCFT) and may require higher startup voltage(Vs).

12.4 Others

- (a) Ultra-violet ray filter is necessary for outdoor operation.
- (b) Avoid condensation of water. It may result in improper operation or disconnection of electrode.
- (c) Do not exceed the absolute maximum rating value. (supply voltage variation, input voltage variation, variation in part contents and environmental temperature, and so on)
Otherwise the module may be damaged.
- (d) If the module keeps displaying the same pattern for a long period of time, the image may be "sticked" to the screen.
To avoid image sticking, it is recommended to use a screen saver.
- (e) This module has its circuitry PCB's on the rear side and should be handled carefully in order not to be stressed.
- (f) Please contact SEC in advance when you display the same pattern for a long time.