



ELECTRONICS

Approval

TO : KDS

Date : 1999.11.18

SAMSUNG TFT-LCD
MODEL NO. : LT181E2-131

Note:

Any Modification of Spec is not allowed without SEC's permission.

Prepared by :  이주만 1999-11-18

Checked by :  조유동 1999-11-18

Approved by :  이배원 1999-11-18

Samsung Electronics Co . , LTD.

Contents

Revision History	----- (3)
General Description	----- (4)
1. Absolute Maximum Ratings	----- (5)
1.1 Absolute Ratings Of Environment	
1.2 Electrical Absolute Ratings	
2. Optical Characteristics	----- (7)
3. Electrical Characteristics	----- (13)
3.1 TFT LCD Module	
3.2 Back-light Unit	
4. Block Diagram	----- (16)
4.1 TFT LCD Module	
4.2 Back-light Unit	
5. Input Terminal Pin Assignment	----- (17)
5.1 Input Signal & Power	
5.2 TMDS Interface	
5.3 Back-light Unit	
5.4 Input Signals, Basic Display Colors and Gray Scale of Each Color	
6. Interface Timing	----- (21)
6.1 Timing Parameters (DE only mode)	
6.2 Timing Diagrams of interface Signal (DE only mode)	
6.3 Power ON/OFF Sequence	
7. Outline Dimension	----- (24)
8. Reliability Test	----- (25)
9. Packing	----- (26)
10. Marking & Others	----- (27)
11. Inspection Criteria	----- (29)
12. General Precaution	----- (30)
12.1 Handling	
12.2 Storage	
12.3 Operation	
12.4 Others	

* Revision History

Date	Rev. No	Page	Summary		
Oct. 20.1998	000		LT181E2-131 model was issued for the first time.		
Nov. 25.1998	001	7	Added the Color Chromaticity(CIE)		
		7	Brightness Uniformity 30%(Max) , Changed to 20%(Max)		
		7	Added the Flicker and Crosstalk		
		20	Changed the Item 6.1 Timing Parameters		
		22	Changed the Item 6.3 Power On/Off Sequence		
		Dec.19. 1998	002	4	Changed the Haze, using Conductive Pol
				6	Changed the Electrical Absolute rating for lamp current
				7	Changed the several Optical Characteristics
				10	Added Measurement Equipment in Note(4)
				10	Changed the measurement point in vote(5),(6)
10	Changed the uniformity definition to be $(B_{max}-B_{min})/B_{max}*100$				
12	Corrected the several data in the table				
14	Corrected the several several data in the table				
16	Corrected the function of Input pin (8,9,10) to be NC				
17	TMDS Interface Pin assignment correction				
Jan. 22. 1999	003	20	Added Vertical blank period		
		21	Redraw Timing diagram to be more accurate		
		22	Corrected the T5 and T6 time		
		5	Changed the module size		
			Changed the 93.8%max RH to the 90%max RH in note(1)		
		6	Changed the Lamp frequency to 30KHz(MIN)		
		7	Changed the Lamp current for measurement.		
		12	Corrected the power consumption data.		
		14	Corrected the Lamp current and Operating life time.		
		16	Corrected the function of Input symbol pin		
Jan. 25. 1999	004	20	Corrected the timing in vertical active display term.		
		21	Redraw timing diagram to be more accurate		
		22	Changed the time of T5		
		24	Added the item 8. Packing		
		25	Added the item 9. Marking & Others.		
		24	Added the item 8. Reliability Test		
		28	Added the item 10. Inspection Criteria		
		Feb. 22. 1999	005	14	Changed the Operating life time, 25,000hr(12.0mA) to be 25,000hr(12.4mA).
		Mar. 29. 1999	006	7-	Added several items in the table
					- Chromaticity Uniformity
	- Specular Reflectance				
	- Image sticking				
	- Luminance of White (10K POH)				
	Changed several items in the table				
	- Response time				
14	Corrected the power consumption data				
22	Corrected the timing parameters in the table				
Oct. 04. 1999	007			5	Changed Shock & Vibration condition
		7	Added Image sticking spec for relax time 2.0		
		7-	Changed several test conditions		
		15	Changed lamp life time min : TBD , typ :14000Hrs		
		21	Changed timing table		
Nov. 18. 1999	008	15	Changed lamp life time min : 20,000		
		25	Changed several reliability condition		

General Description

* Description

LT181E2-131 is a color active matrix TFT (Thin Film Transistor) liquid crystal display (LCD) that uses amorphous silicon TFTs as a switching devices. This model is composed of a TFT LCD panel, a driver circuit and a back-light system. The resolution of a 18.1" contains 1280 x 1024 pixels and can display up to 16 million colors with wide viewing angle of 80° or higher in all directions. (Vertical viewing angle : 160° , Horizontal viewing angle : 160°)

* Features

- High contrast ratio, high aperture structure
- CE(coplanar Electrode) mode
- Wide viewing angle
- High speed response
- SXGA(1280 x 1024 pixels) resolution
- Low Power consumption
- 2 dual CCFT(Cold Cathode Fluorescent Tube)
- DE only mode
- TMDS(Transition Minimized Differential Signaling) interface

* Applications

Workstation & desktop monitors

Display terminals for AV application products

Monitors for industrial machine

* General information

Items	Specification	Unit	Note
Display area	359.04(H) x 287.23(V)(18.1 inch diagonal)	mm	
Driver element	a-Si TFT active matrix		
Display colors	16M(with FRC)	colors	
Number of pixels	1280 x 1024	pixel	
Pixel arrangement	RGB vertical stripe		
Pixel pitch	0.2805(H) x 0.2805(W)	mm	
Display mode	Normally Black		
Surface treatment	Haze 25% , Hard - coating (3H)		

*** Mechanical information**

Item	Min.	Typ.	Max.	Note	
Module size	Horizontal(H)	409.5	410.0	410.5	mm
	Vertical(V)	334.5	335.0	335.5	mm
	Depth(D)	-	-	25.0	mm
Weight	-	-	2,500	g	

1. Absolute Maximum Ratings

1.1 Absolute ratings of environment

Item	Symbol	Min.	Max.	Unit	Note
Storage temperature	T _{STG}	-20	65	°C	(1)
Operating temperature (Ambient temperature)	T _{OPR}	0	50	°C	(1)
Shock (non - operating)	Snop	-	220	G	(2),(4)
Vibration (non - operating)	Vnop	-	1.5	G	(3),(4)

Note (1) Temperature and relative humidity range are shown in the figure below.

90 % RH Max. (40 °C ≥ Ta)

Maximum wet-bulb temperature at 39 °C or less. (Ta > 40 °C) No condensation.

- (2) 2ms, sine wave, one time for ±X, ±Y, ±Z axis
- (3) 10-300 Hz, Sweep rate 10min, 30min for X,Y,Z axis
- (4) At testing Vibration and Shock, the fixture in holding the Module to be tested have to be hard and rigid enough so that the Module would not be twisted or bent by the fixture.

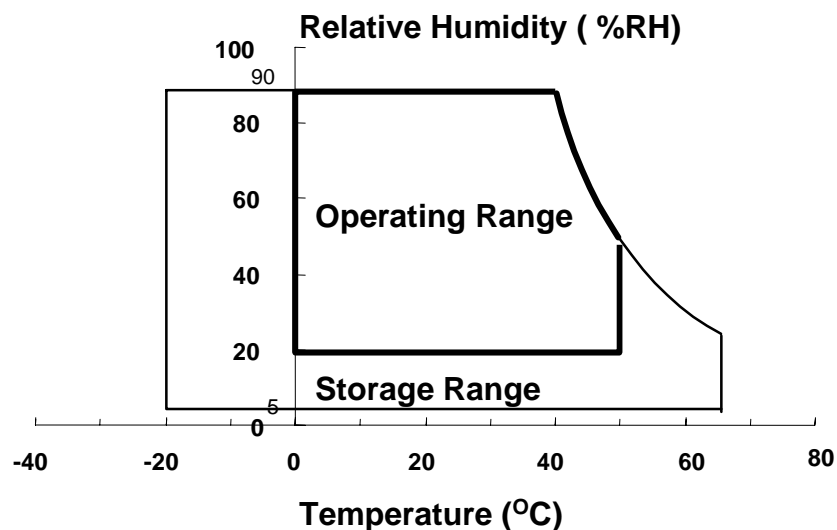

1.2 ELECTRICAL ABSOLUTE RATINGS

(1) TFT LCD Module

(V_{SS} = GND = 0 V)

Item	Symbol	Min.	Max.	Unit	Note
Power Supply Voltage	VDD	V _{SS} -0.5	6.5	V	(1)

NOTE (1) Within Ta (25 ± 2 °C)

(2) BACK-LIGHT UNIT

(Ta = 25 ± 2°C)

Item	Symbol	Min.	Max.	Unit.	Note
Lamp Current	IL	6.0	16.0	mArms	(1),(2)
Lamp Frequency	fL	30	80	kHz	(1)

NOTE (1) Permanent damage to the device may occur if maximum values are exceeded. Functional operation should be restricted to the conditions described under Normal Operating Conditions.

- (2) Specified values are for a dual lamp(Refer to the Note (1) in the page 15 for further information).

2. Optical Characteristics

The following items are measured under stable conditions. The optical characteristics should be measured in a dark room or equivalent state with the methods shown in Note (1).

Measuring equipment : TOPCON BM-5A , BM-7, PHOTO RESEARCH PR650

* Ta = 25 ± 2°C , VDD=5V, fv= 60Hz, fDCLK=54 MHz, IL = 13.0 mA_{rms}

Item		Symbol	Condition	Min.	Typ.	Max.	Unit	Note
Contrast Ratio (Center of screen)		C/R		150	-	-		(3) BM-5A
Response Time	Rising	Tr		-	20	30	msec	(4)
	Falling	Tf		-	30	40		BM-7
Luminance of White (Center of screen)		YL	Normal φ = 0	150	170	-	cd/m ²	(5) BM-5A
Color Chromaticity (CIE 1931)	Red	Rx	Viewing Angle	-0.03	0.607	+0.03		(6) PR650
		Ry			0.344			
	Green	Gx			0.304			
		Gy			0.565			
	Blue	Bx			0.145			
		By			0.118			
	White	Wx			0.310			
		Wy			0.335			
Viewing Angle	Hor.	θ L	CR≥10	70	80	-	Degrees	(7) BM-5A
		θ R		70	80	-		
	Ver.	φ H		70	80	-		
		φ L		70	80	-		
Brightness Uniformity (9 points)		Buni		-	-	25	%	(8) BM-5A
Flicker		F		-	-	5	%	(9) BM-7
Crosstalk		CT		-	-	5	%	(10) BM-5A
Image Sticking	Aging	R		-	-	2.5		(11)
	Relax	R		-	-	2.0		BM-5A

Note 1) Test Equipment Setup

After stabilizing and leaving the panel alone at a given temperature for 30 min , the measurement should be executed. Measurement should be executed in a stable, windless, and dark room. 30 min after lighting the back-light. This should be measured in the center of screen. Dual lamp current : 13.0mA (6.5mA x 2) (Refer to the note(1) in the page 15 for more information.)

Environment condition : $T_a = 25 \pm 2 \text{ } ^\circ\text{C}$

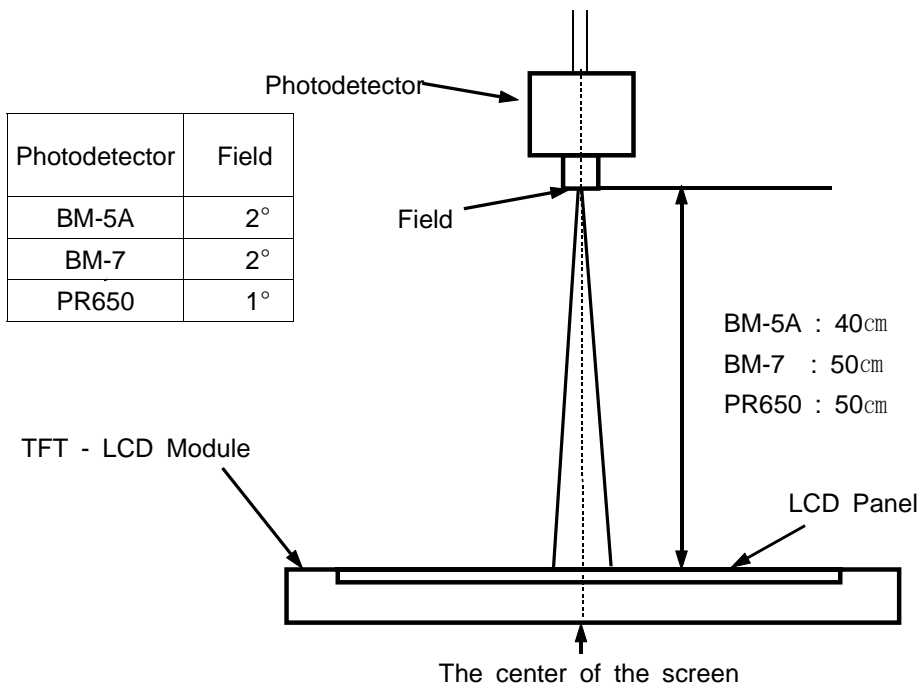

Optical Measuring Equipment Setup

Note 2) Definition of test point

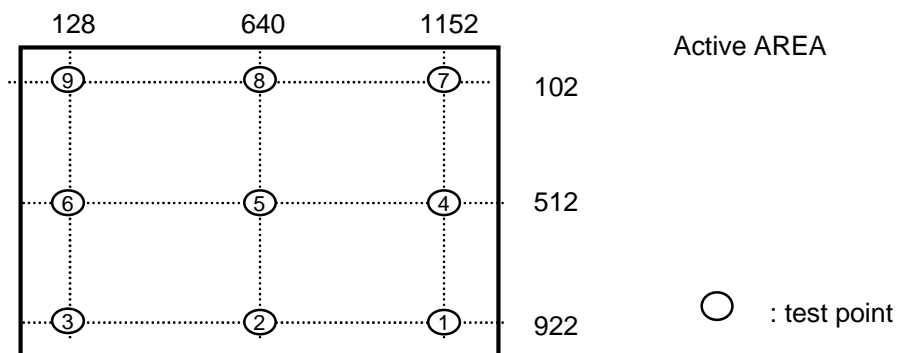

Note 3) Definition of Contrast Ratio (C/R) : Ratio of gray max (Gmax) & gray min (Gmin) at the center point(5) of the panel

$$CR = \frac{G_{max}}{G_{min}}$$

Gmax : Luminance with all pixels white

Gmin : Luminance with all pixels black

Note 4) Definition of Response time : Sum of T_r , T_f

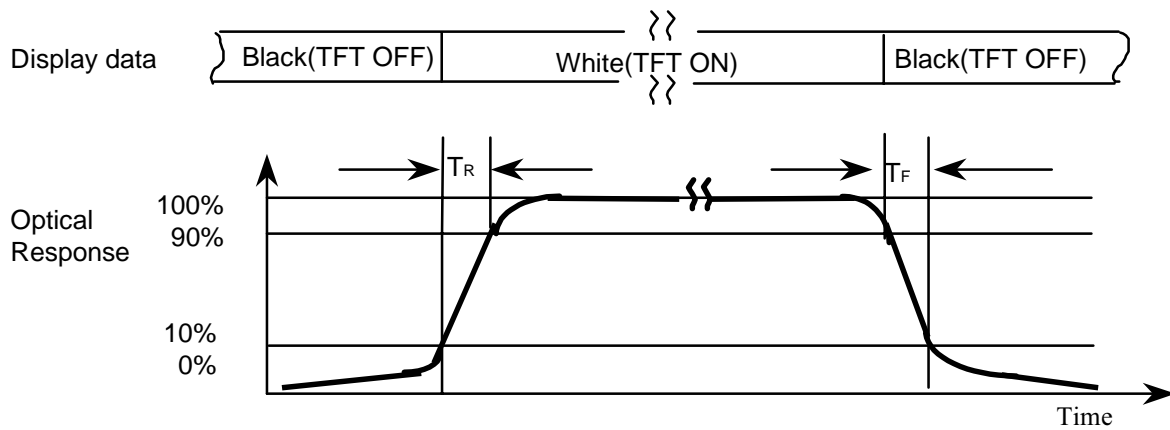

Note 5) Definition of Luminance of White : Luminance of white at center point(5).

Note 6) Definition of Color Chromaticity (CIE 1931)

Color coordinate of Red , Green , Blue & White at center point(5).

Note 7) Definition of Viewing Angle : Viewing angle range ($CR \geq 10$)

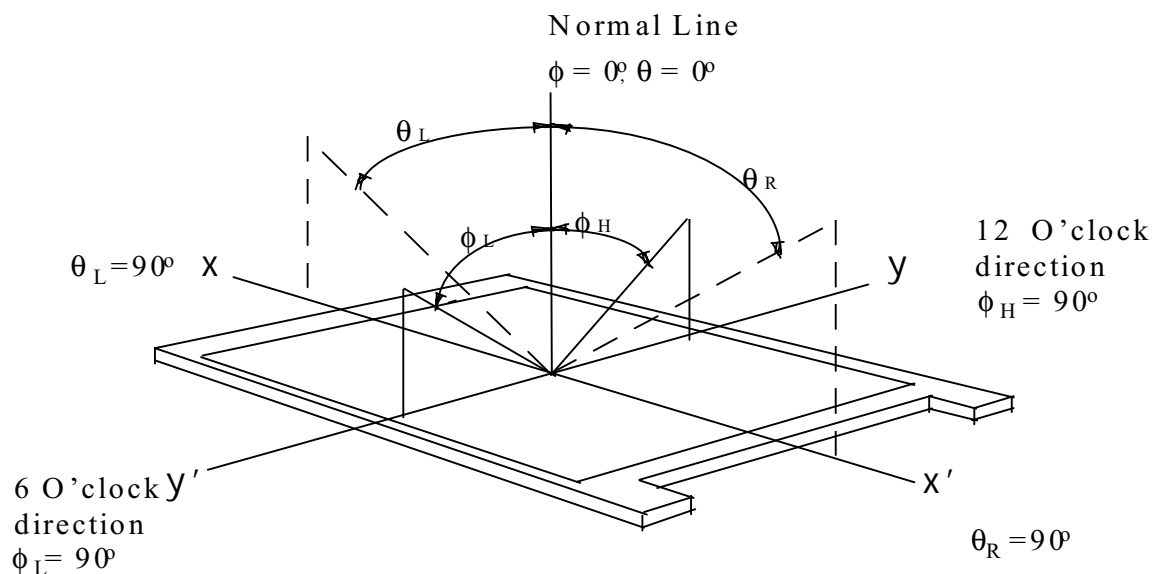

Note 8) Definition of 9 points brightness uniformity

$$B_{uni} = 100 * \frac{(B_{max} - B_{min})}{B_{max}}$$

B_{max} : Maximum brightness

B_{min} : Minimum brightness

Note 9) Definition of Flicker level

$$F = \frac{Flicker_Voltage_pp}{LMD_Voltage_dc} * 100\%$$

One maximum value of three estimated values

For this test, an LMD(Light Measurement Device) is needed with adequate response time to track any visible rate flicker component and with a voltage level output proportional to luminance intensity

Test Pattern : For dot inversion Driving(Gray levels of foreground dots on the test panel are G22, G32, and G45)

Test Point : Center point of the display area

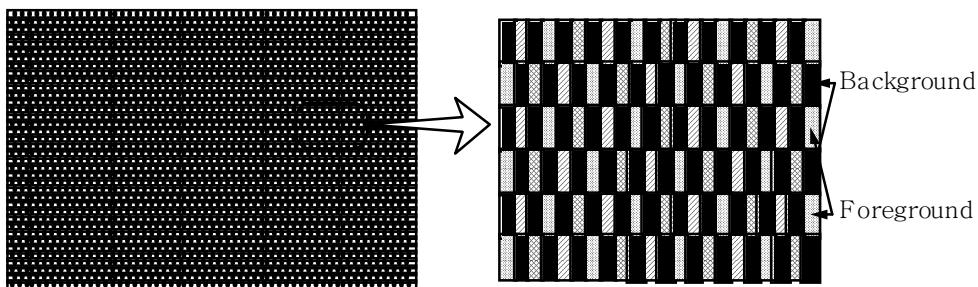

Note 10) Definition of Crosstalk Test Method (Refer to the VESA STD)

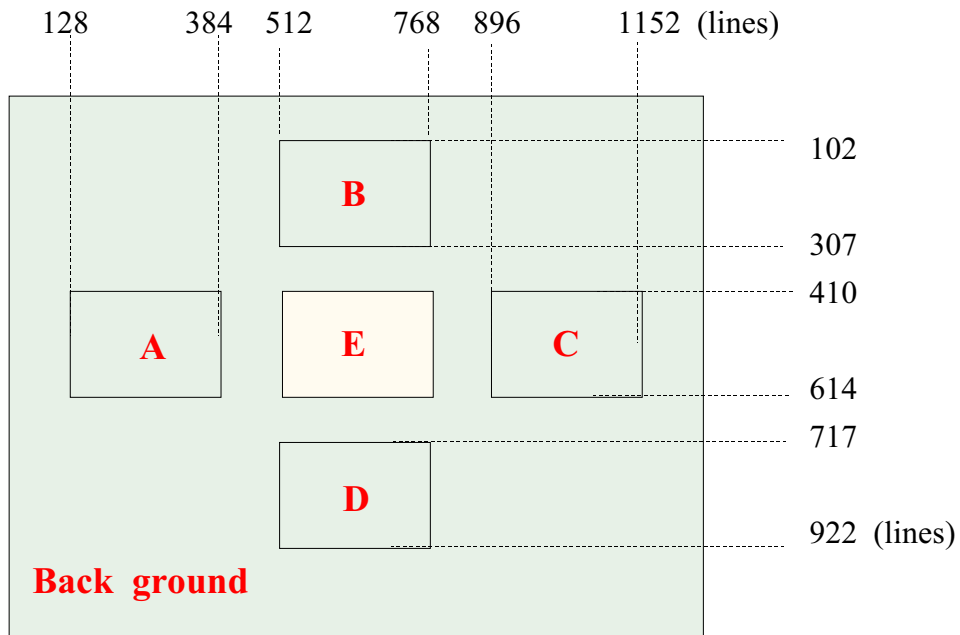

Procedure

Step (1) Determine background and foreground gray levels (colors) to select the worst case shadowing pattern

(Ex Background : 50% gray white pattern , Foreground : Pure white pattern)

Step (2) Determine the worst shadowing box (between Box A,B,C,D & E) using the same condition at Step (1) gray levels (colors)

Step (3) Determine test most shadowing position of selected box at Step 2>

Step (4) Check the brightness of selected position of Step (3) with selected box(at Step (2)) & without selected box (at Step (2))

$$CT = \frac{|L_{max} - L_{min}|}{L_{min}} * 100\%$$

Lmax : the larger Brightness value of selected position

Lmin : the smaller brightness value of selected position

Note 11) Definition of Image Sticking

17*17 Black/White Pattern

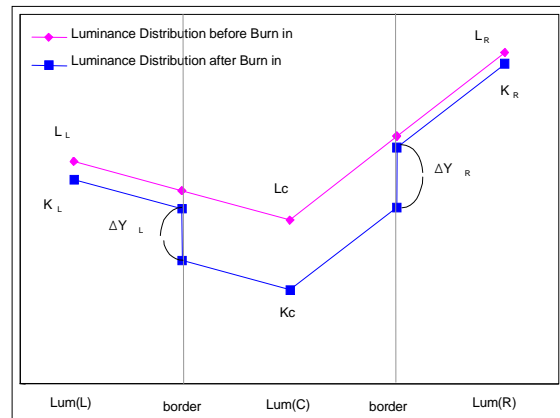
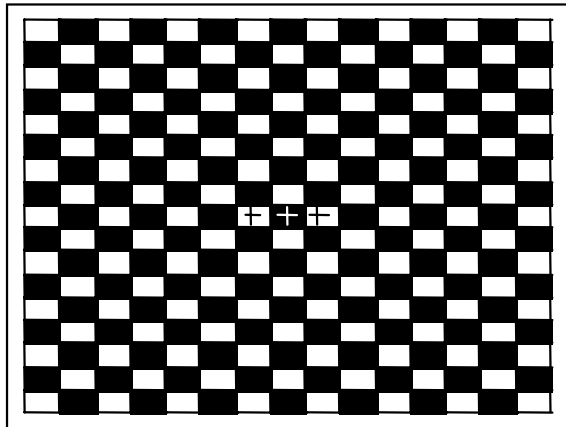

< Supposed luminance distribution
of the panel >

< Measurements Locations and Box size >

Procedure

Step (1) Check the brightness of 3points(Center:LC, Left:LL, Right:LR) before aging at 50% gray level.

Step (2) Burn-in test with W/B checker pattern(17*17) for 10hrs.

Step (3) Next check the brightness on the same position (KC, Left:KL, Right:KR) after aging at 50% gray level.

*** Check Residual factor R at 10 hours aging time**

Step (4) Relax panel with 50% Gray level Pattern for 5hr.

Step (5) Next check the brightness on the same position (KC, Left:KL, Right:KR) after relaxation at 50% gray level.

*** Check Residual factor R at 5 hours relax time**

*** Image sticking factor calculation formula**

$$R_{L,R} = (100 - L^*) = 116 \left(1 - \left(1 - \frac{\Delta Y_{L,R}}{\max(K_C, K_L)} \right)^3 \right)^{\frac{1}{3}}$$

$R_{L,R}$: Max value of image sticking between left&light area

$$\Delta Y_{L,R} = \text{abs}((K_{L,R} - L_{L,R}) - (K_C - L_C))$$

$\Delta Y_{L,R}$: Max value of luminance difference between left&light area
after aging

$\max(K_C, K_L)$: Max value of luminance between left&light area

3. Electrical Characteristics

3.1 TFT LCD MODULE

Ta = 25°C

Item	Symbol	Min.	Typ.	Max.	Unit	Note
Voltage of Power Supply	VDD	4.5	5.0	5.5	V	
Current of Power Supply	Black	-	550	700	mA	(1)
	Mosaic	-	780	950	mA	
	2 line V stripe	-	1100	1300	mA	
Vsync Frequency	fV	-	60	60	Hz	(2)
Hsync Frequency	fH	-	64	64	kHz	
Main Frequency	fDCLK	-	54	54	MHz	
Rush Current	Irush	-	4.0	4.0	A	(4)

- Note
- (1) fV=60Hz, fDCLK =54MHZ, VDD = 5.0V, DC Current.
 - (2) Main pixel clock frequency is the value which is measured at the input of TMDS transmitter.
 - (3) Power dissipation check pattern(LCD Module only)

*a) Black Pattern

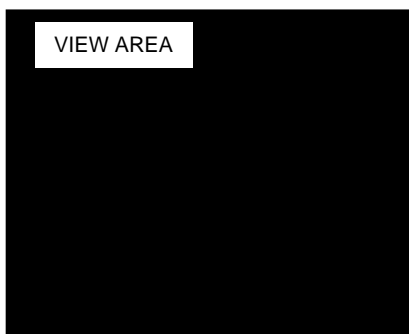

*b) Mosaic Pattern

Display Brightest Gray Level →
 Display Darkest Gray Level →

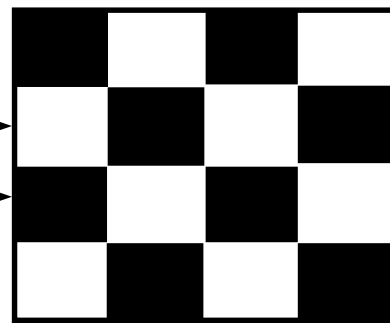

*c) 2line Vertical stripe pattern

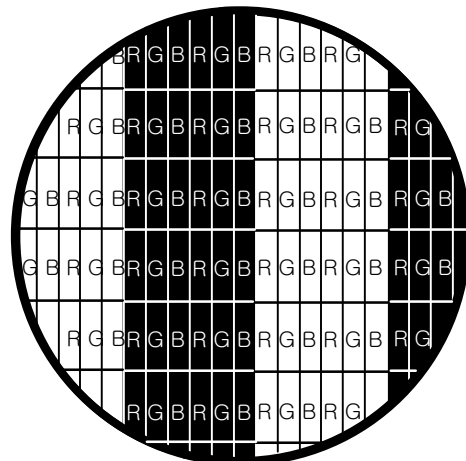
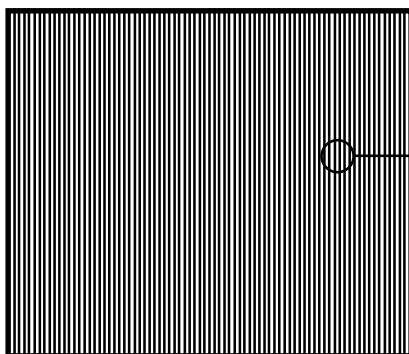

(4) Measurement Conditions

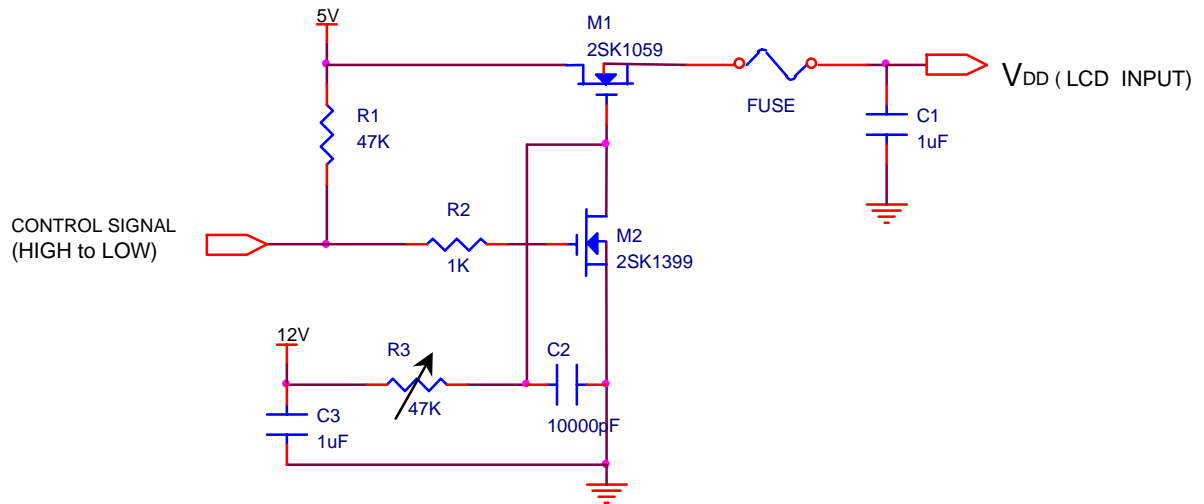

Note : Control Signal : High(+5V) -->Low(Ground)

All Signal lines to panel except for power 5V : Ground

The rising time of supplied voltage is controlled to 470us by R3 and C2 value.

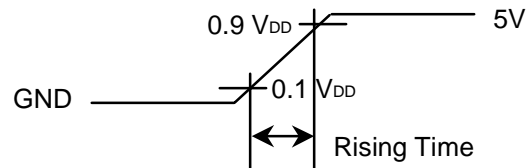

3.2 BACK-LIGHT UNIT

The back-light system is an edge - lighting type with 2 dual CCFTs (Cold Cathode Fluorescent Tube)

The characteristics of two dual lamps are shown in the following tables.

INVERTER : SIC-172

Ta=25 ± 2°C

Item	Symbol	Min.	Typ.	Max.	Unit	Note
Lamp Current	IL	6.0	13.0	13.0	mArms	(1)
Lamp Voltage	VL	-	780	-	Vrms	
Lamp Frequency	fL	30	-	60	kHz	(2)
Operating Life Time	Hr (13mA)	20000	-	-	Hour	(3)
Startup Voltage	Vs	-	-	1240(25°C)	Vrms	(4)
				1700(0°C)		

Note) The waveform of the inverter output voltage must be area symmetric and the design of the inverter must have specifications for the modularized lamp.

The performance of the back-light, for example life time or brightness, is much influenced by the characteristics of the DC-AC inverter for the lamp. So all the parameters of an inverter should be carefully designed so as not to produce too much leakage current from high-voltage output of the inverter.

When you design or order the inverter, please make sure that a poor lighting caused by the mismatch of the back-light and the inverter(miss lighting, flicker, etc.) never occur. When you confirm it, the module should be operated in the same condition as it is installed in your instrument.

Note (1) Dual lamp current is measured with current meter for high frequency as shown below.

Refer to the block diagram of the back-light unit in the next page for more information.

Specified values are for a dual lamp.

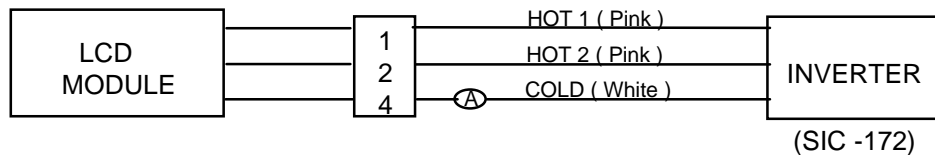

(2) Lamp frequency may produce interference with horizontal synchronous frequency and this may cause line flow on the display. Therefore lamp frequency shall be detached from the horizontal synchronous frequency and its harmonics as far as possible in order to avoid interference.

(3) Life time (Hr) of a lamp is defined as the time in which it continues to operate under the condition of Ta = 25±2°C and IL = 13.0mArms for dual lamps until the brightness becomes 50% or lower than its original value.

(4) If an inverter has shutdown function it should keep its output for more than 1 second even if the lamp connector open. Otherwise the lamps may not to be turned on.

4. Block Diagram

4.1 TFT LCD MODULE

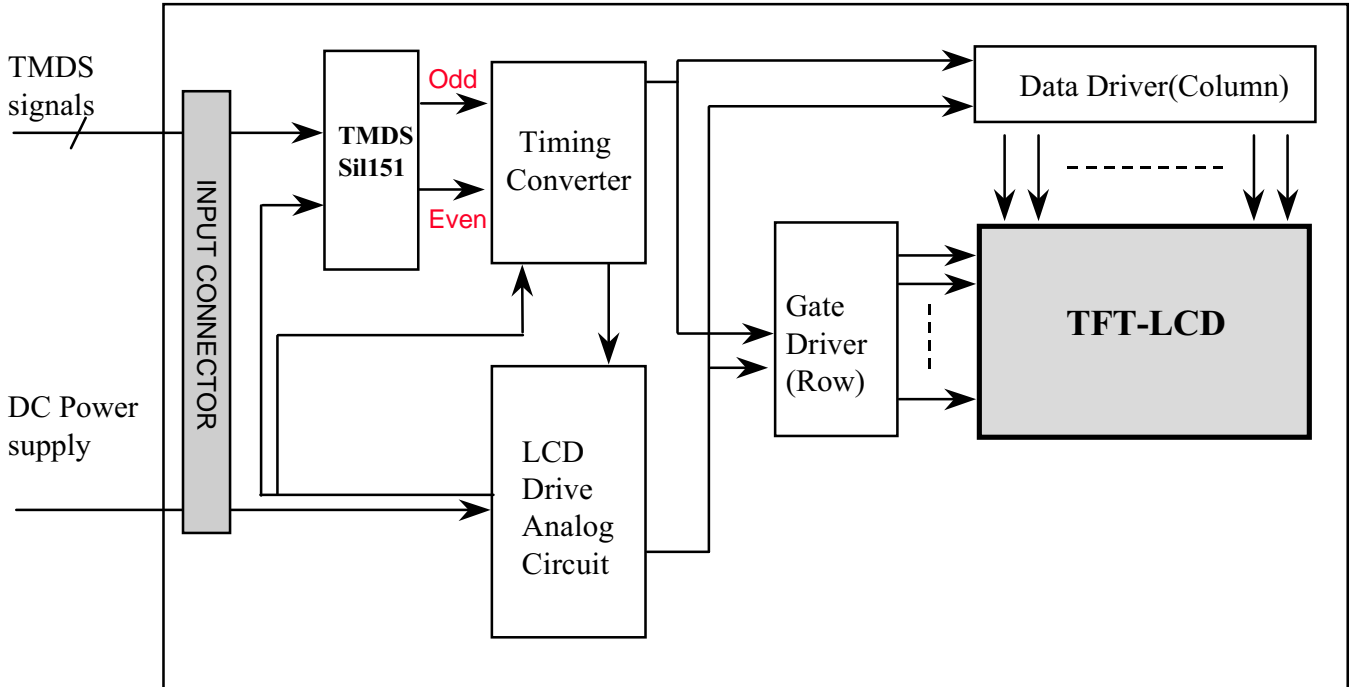

4.2 BACK-LIGHT UNIT

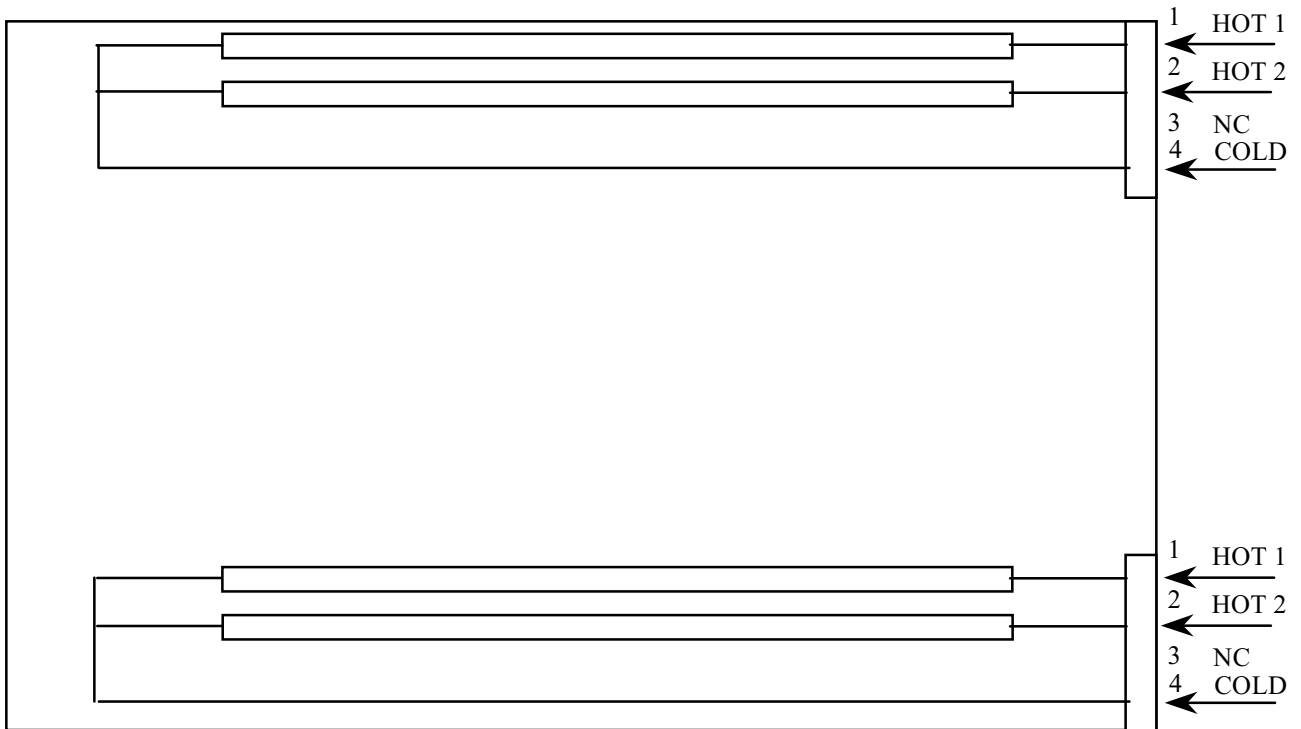

5. Input Terminal Pin Assignment

5.1. Input Signal & Power (Connector : JAE FI-WE31P-HF)
(Matching Socket : JAE FI-WE31S-HF)

Pin No	Symbol	Function	Polarity	Output Pin # (Transmitter)
1	VDD	Power Supply +5.0V		
2	VDD			
3	VDD			
4	VDD			
5	VDD			
6	VDD			
7	NC	No Connection		
8	NC			
9	NC			
10	NC			
11	NC			
12	NC			
13	GND	Power Ground		
14	GND			
15	RXC-	TMDS Clock - Signal	Negative	PIN #34
16	RXC+	TMDS Clock + Signal	Positive	PIN #35
17	GND	Power Ground		
18	GND			
19	RX0-	TMDS Receiver 0- Signal	Negative	PIN #39
20	RX0+	TMDS Receiver 0+Signal	Positive	PIN #40
21	GND	Power Ground		
22	GND			
23	RX1-	TMDS Receiver 1- Signal	Negative	PIN #42
24	RX1+	TMDS Receiver 1+ Signal	Positive	PIN #43
25	GND	Power Ground		
26	GND			
27	RX2-	TMDS Receiver 2- Signal	Negative	PIN #45
28	RX2+	TMDS Receiver 2+ Signal	Positive	PIN #46
29	GND	Power Ground		
30	GND			
31	NC	No Connection		

5.2 TMD5 Interface

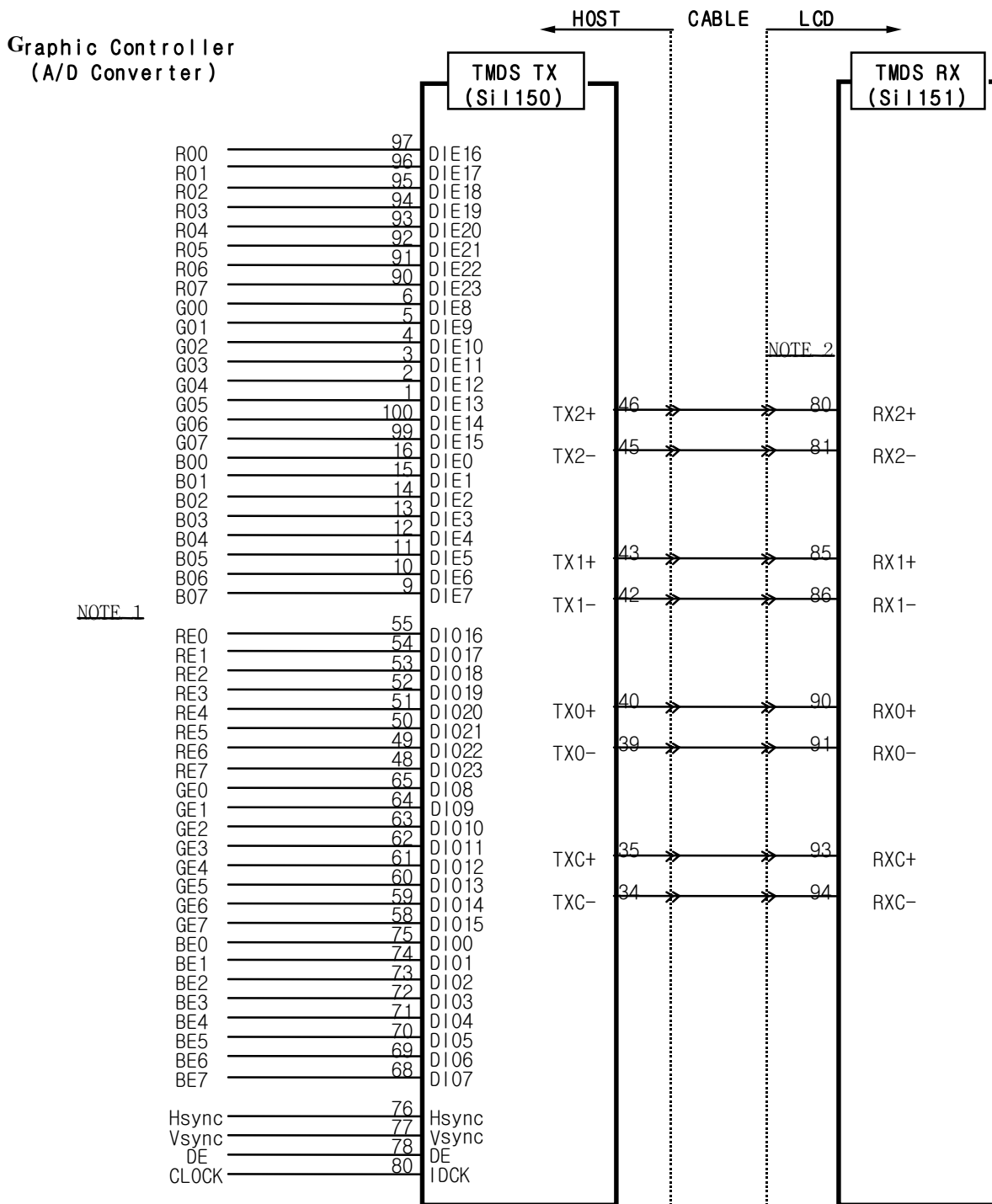

Note 1 : Signal Configuration [Graphic Controller (A/D Converter) Base]
 Odd Data (ROx, BOx, GOx : 1'st, 3'rd, 5'th data)
 Even Data (REx, GEx, BEx : 2'nd, 4'th, 6'th data)

Note 2 : Use FI-WE31P-HF JAE Connector on the TFT module side
 Use Twisted Differential Cable (Impedance : 50 Ω)

5.3 BACK-LIGHT UNIT

Pin No.	Input [ch1] ,[ch2]	Color	Fucntion
1	Hot 1	Pink	High Voltage
2	Hot 2	Pink	High Voltage
3	N.C	-	No Connection
4	Cold	White	Ground
Connector Part No.	JST BHR - 04VS - 1		

6. Interface Timing

6.1 Timing Parameters (DE only mode)

Signal	Item	Symbol	Min.	Typ.	Max.	Unit	Note
Clock	Frequency	1/Tc	-	54	54	Mhz	
	High Time	TCH	5	-	-	nsec	
	Low Time	TCL	5	-	-	nsec	
Data	Setup Time	TDS	4	-	-	nsec	
	Hold Time	TDH	4	-	-	nsec	
Data Enable	Setup Time	TES	4	-	-	nsec	(1)
Frame Frequency	Cycle	Tv	1028	1066	1066	lines	
Vertical Active Display Term	Display Period	TVD	1024	1024	1024	lines	
	Vertical Blank Period	TVB	844 * n + a			clocks	(2)
Online Scanning Time	Cycle	TH	656	-	844	clocks	
Horizontal Active Display Term	Display Period	THD	640	640	640	clocks	

Note (1) When LT181E2-131 model is operated by DE only mode, Hsync and Vsync input signals should be fixed to low for stable operation. Otherwise, the module could operate abnormally.

(2) $n \geq 4$, $4 \leq a \leq 725$

* Interfacing timing check point

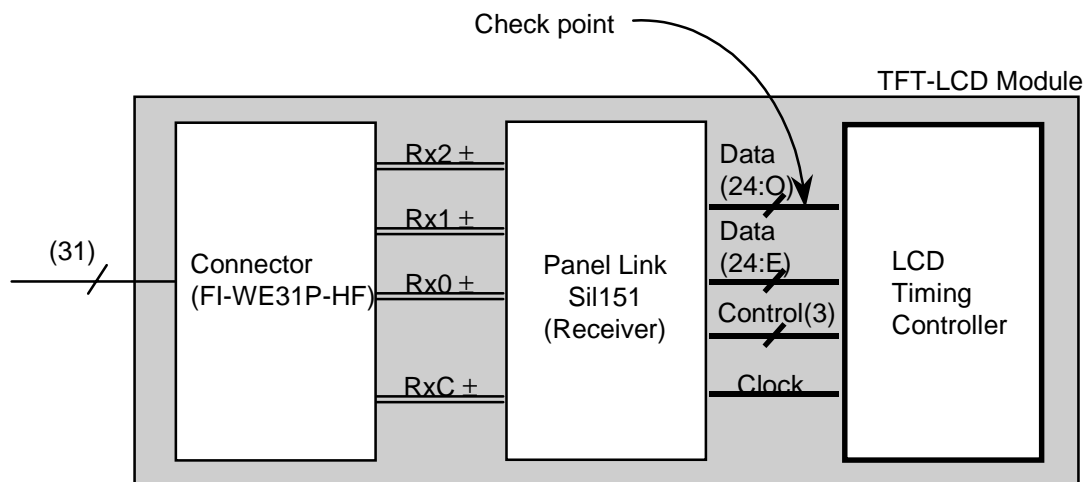

6.2 Timing diagrams of interface signal (DE only mode)

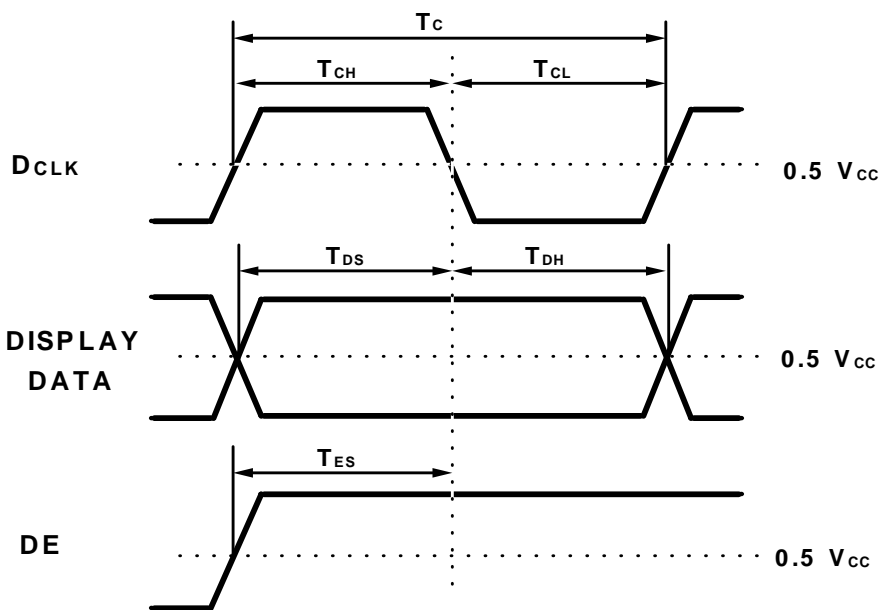
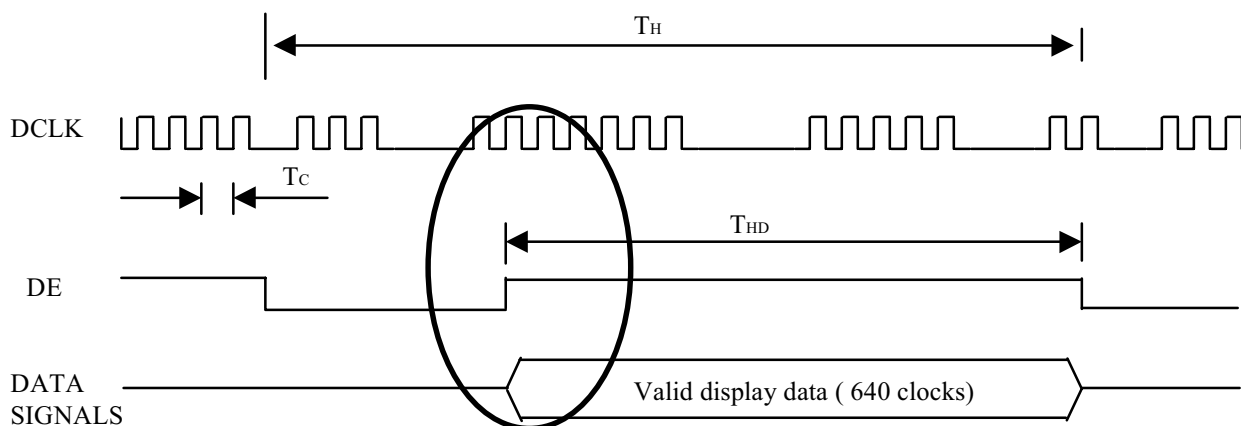
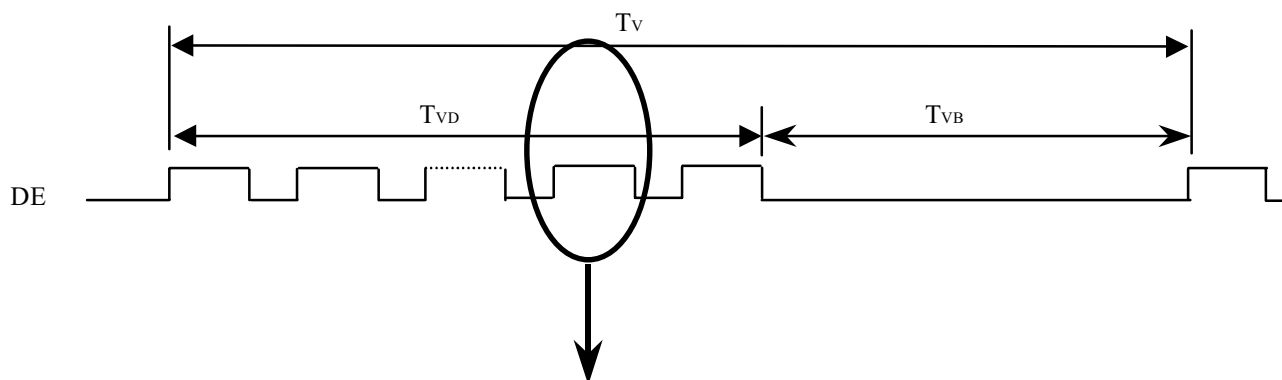

6.3 Power ON/OFF Sequence

: To prevent a latch-up or DC operation of the LCD module, the power on/off sequence should be as the diagram below.

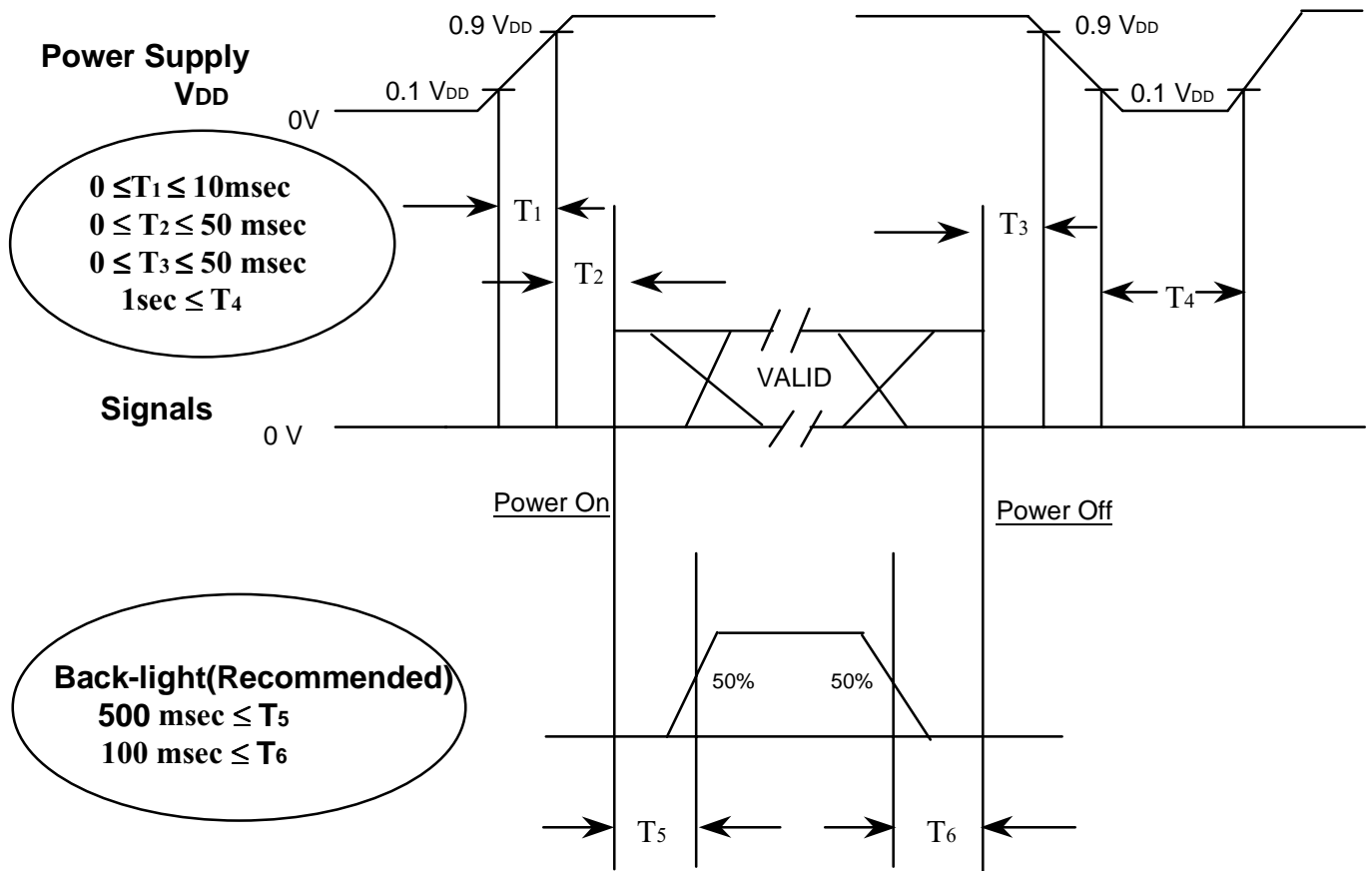

Power ON/OFF Sequence

NOTE.

- (1) The supply voltage of the external system for the module input should be the same as the definition of VDD.
- (2) Apply the lamp voltage within the LCD operation range. When the back-light turns on before the LCD operation or the LCD turns off before the back-light turns off, the display may momentarily become abnormal screen.
- (3) In case of VDD = off level, please keep the level of input signals on the low or keep a high impedance.
- (4) T₄ should be measured after the module has been fully discharged between power off and on period.
- (5) Interface signal shall not be kept at high impedance when the power is on.

7. Outline Dimension

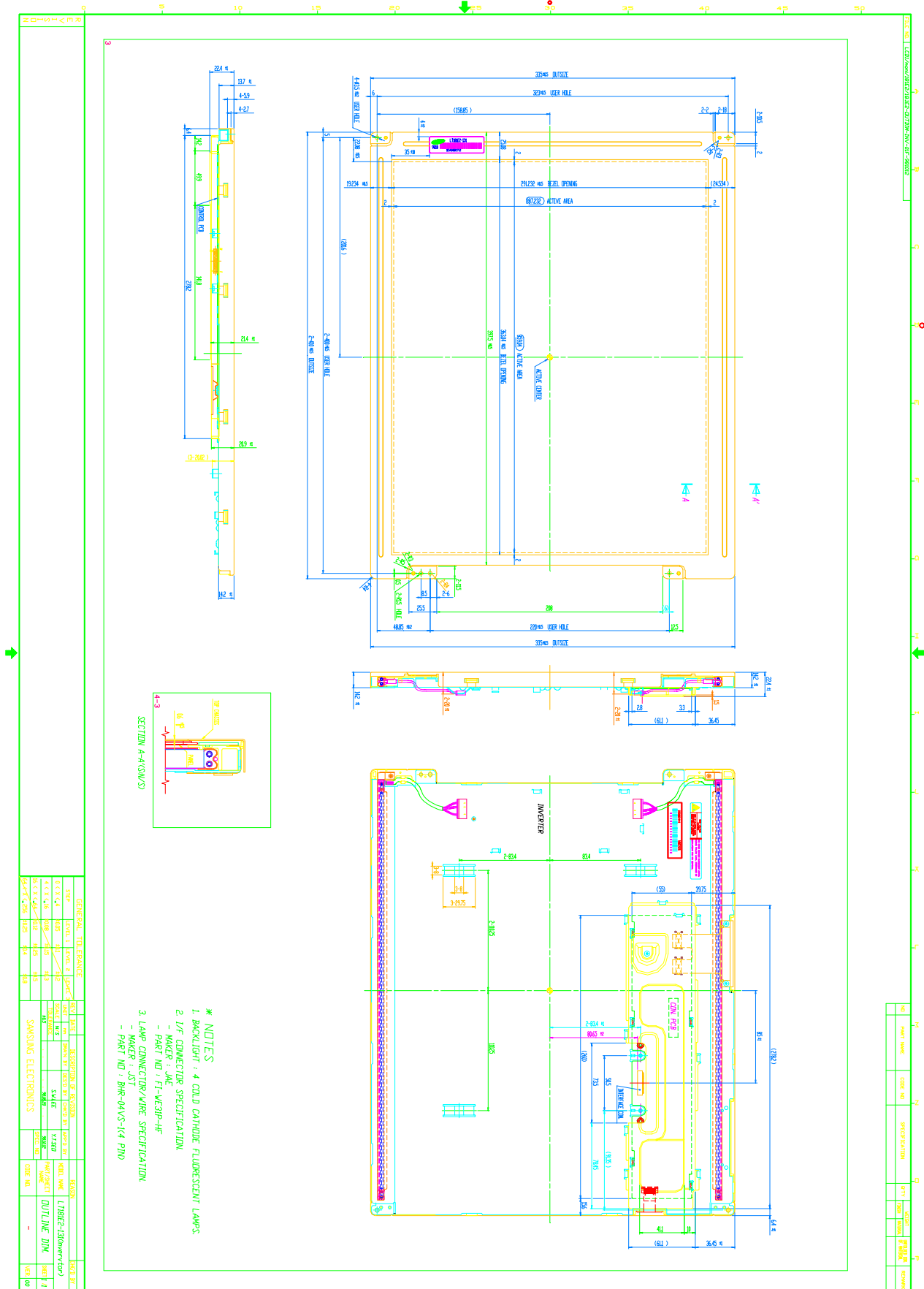

8. Reliability Test

Test Items	Conditions	Time/Cycle	Sample
HTOL*	50°C , Bias	250 hrs	10
LTOL*	0°C , Bias	250 hrs	5
THB**	40°C / 95% , Bias	250 hrs	5
HTS***	70°C , No Bias	250 hrs	5
LTS***	-30°C , No Bias	250 hrs	5
Thermal Cycle	-20°C/20min ~ +60°C/20min , No bias	100 cycle	5
Box drop	1 angle , 3 edge , 6 side , 66 cm	-	5
Shock (Non-operatine)	220G , 2msec Sine wave , ± x/y/z axis	1 time/axis	3
Vibration (Non-operating)	1.5G , 10~300 Hz X/Y/Z axis , sweep rate : 10 min	30min/axis	3
ESD (Non-Operating)	Contact : 150pF , 330 ohm, 9times Air : 150pF , 330 ohm, 9times	±10KV ±20KV	3 3

[Result Evaluation Criteria]

Under the display quality test conditions with normal operation state, these shall be no change which may affect practical display function.

- * HTOL/ LTOL : High/Low Temperature Operating Life,
- ** THB : Temperature Humidity Bias
- *** HTS/LTS : High/Low Temperature Storage

9. Packing

9.1 CARTON(Internal Packing)

(1) Packing Form

Corrugated fiberboard box and corrugated cardboard as shock absorber.

(2) Packing Method

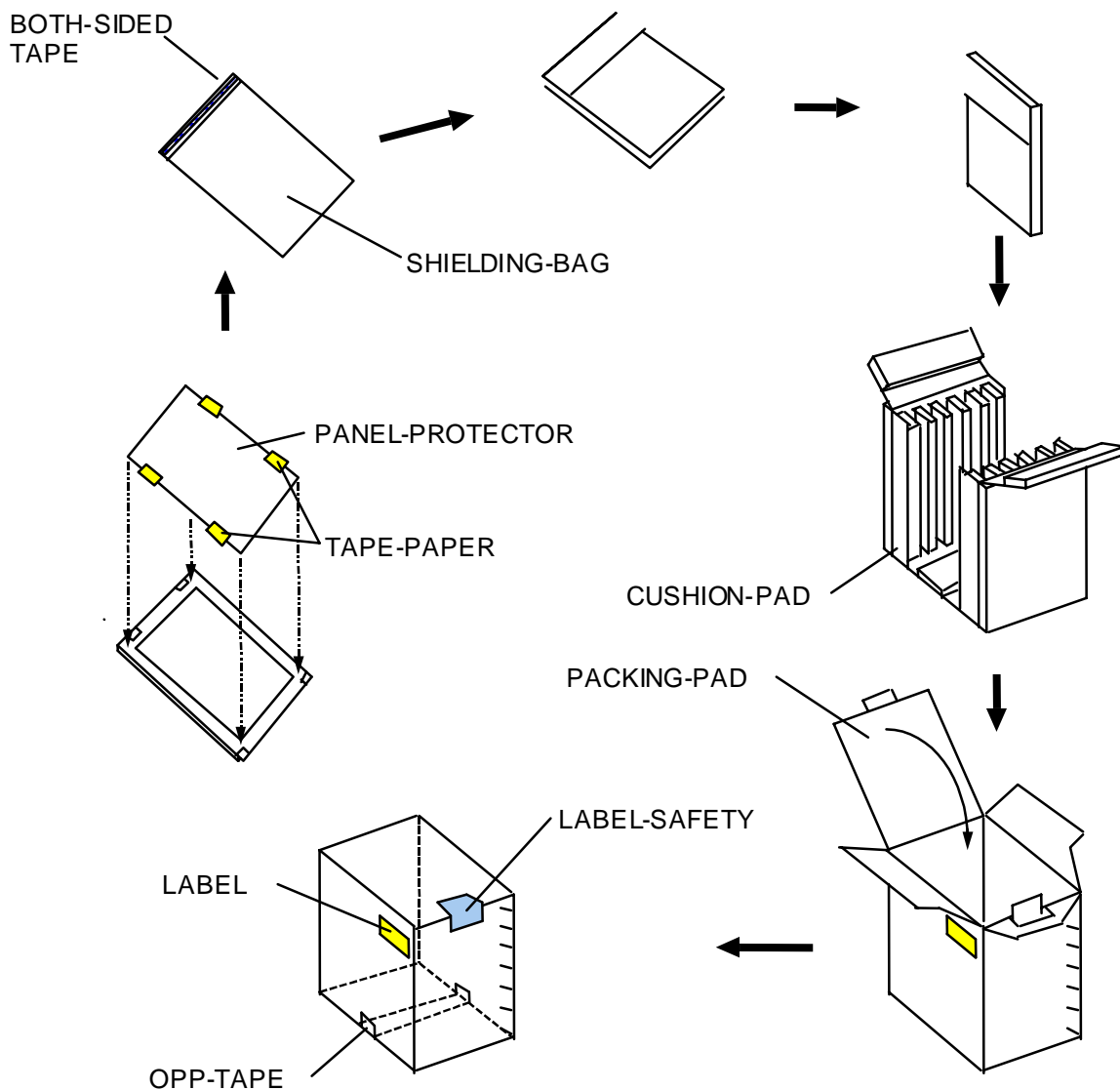

- Note
- 1)Total : Approx. 14.0 Kg
 - 2)Acceptance number of piling : 5 sets
 - 3)Carton size : 401 (W) X 365 (D) X 477 (H)
 - 4)Max accumulation quantity : 5 cartons

(3) Packing Material

No	Part Name	Quantity
1	Static electric protective sack	5pcs
2	Packing case(inner box) including shock absorber	1set
3	Pictorial marking	2pics
4	Carton	1set

10. Marking & Others

A nameplate bearing followed by is affixed to a shipped product at the specified location on each product.

- (1)Parts number : LT181E2-131
- (2)Revision : One letter
- (3)Control Code : One letter
- (4)Lot number : 3 R 0 000 00-00

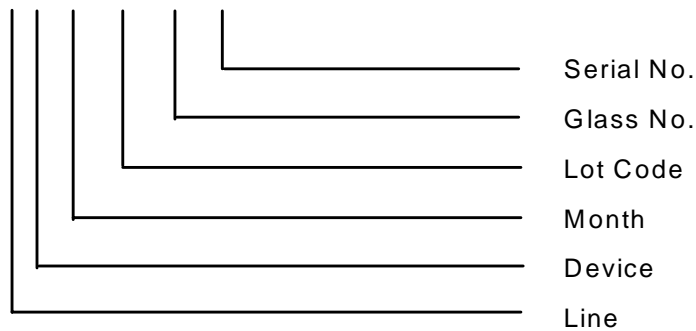

(5) Nameplate Indication

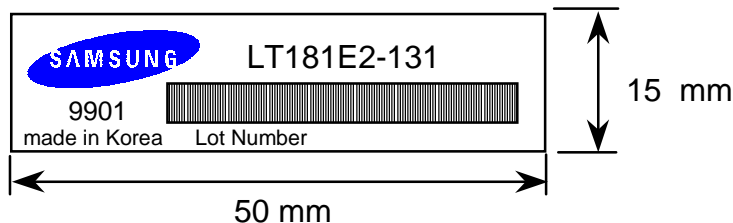

LT181E2-131 :Parts name
9901 :Inspected work week

(6) Bar code marking for Customer

The bar code marking is attached to module backside.

- 1) Model name : LT181E2-131
- 2) SAMSUNG
- 3) MADE IN KOREA
- 4) PRODUCTION NUMBER
- 5) USER MODEL NAME

Bar code shows a) user model name, b) production number

a) User model name

LT181E2-131

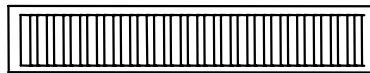

b) Production Number

SAMSUNG
MADE IN KOREA

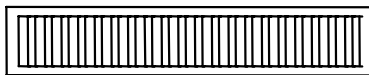

00000000

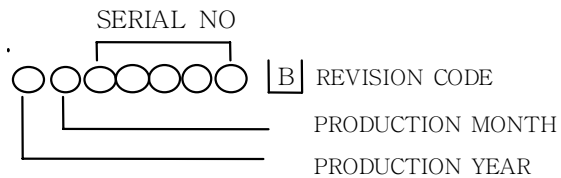

(7) Packing box attach

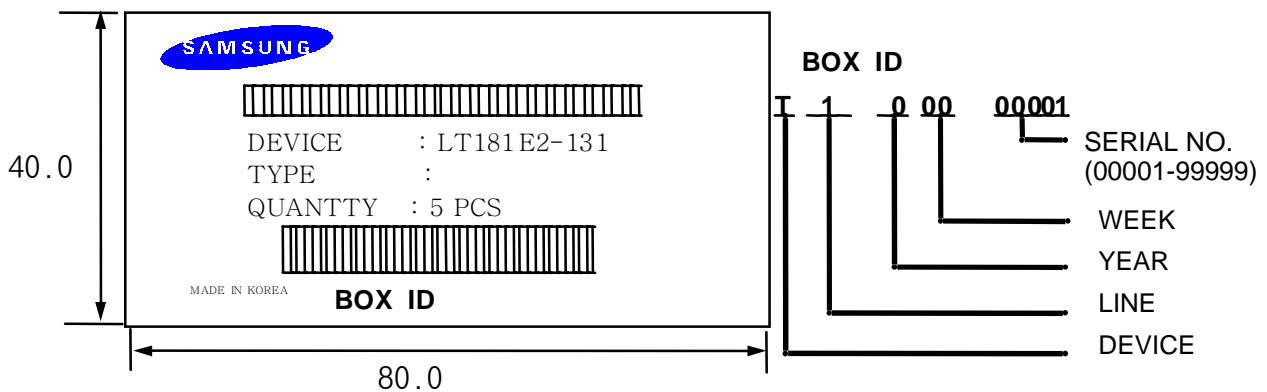

(8) Others

1. After service part

Part Name	Description
Ass'y Lamp(U)	LT181E2-131 , D2.6 , L362 , 4Pin , L150
Ass'y Lamp(L)	LT181E2-131 , D2.6 , L362 , 4Pin , L150

11. Inspection Criteria

When products are shipped, incoming inspection shall be carry out with a sampling inspection based on MIL-STD-105E level II by AQL 1.0%.

CHANGE CONTROL

Design changes may be made for this product relating to the specifications, appearance, parts used, circuits, etc., for the purpose of product improvement. If a design change is judged to affect the specifications of this product, supplier shall inform customer of the change in advance.

QUALITY CONTROL

In the event of a product failure under normal operating conditions, and in the event of product trouble or a functional disorder that can be deemed to be the responsibility of supplier, supplier shall repair the fault or replace the product free of charge within one year of the product delivery date. However, supplier shall not bear responsibility for the quality of a product in the case of modifications other than those specified by supplier.

MAINTENANCE

The specifications of the functions of maintenance parts may be partially changed with in a range which provides for equivalent or better quality. Maintenance parts shall in principle be product units. If manufacture of this product is stopped, supplier shall notify customer in advance.

HANDLING OF DOUBTFUL POINTS

If any doubt arises concerning a matter not stipulated in this specification, the matter is to be resolved by mutual agreement between customer and supplier, and supplier shall make efforts for improvement in good faith.

12. General Precautions

12.1 Handling

- (a) When the module is assembled, It should be attached to the system firmly using every mounting holes. Be careful not to twist and bend the modules.
- (b) Refrain from strong mechanical shock and / or any force to the module. In addition to damage, this may cause improper operation or damage to the module and CCFT back-light.
- (c) Note that polarizers are very fragile and could be easily damaged. Do not press or scratch the surface harder than a HB pencil lead.
- (d) Wipe off water droplets or oil immediately. If you leave the droplets for a long time, Staining and discoloration may occur.
- (e) If the surface of the polarizer is dirty, clean it using some absorbent cotton or soft cloth.
- (f) The desirable cleaners are water, IPA(Isopropyl Alcohol) or Hexane. Do not use Ketone type materials(ex. Acetone), Ethyl alcohol, Toluene, Ethyl acid or Methyl chloride. It might permanent damage to the polarizer due to chemical reaction.
- (g) If the liquid crystal material leaks from the panel, it should be kept away from the eyes or mouth . In case of contact with hands, legs or clothes, it must be washed away thoroughly with soap.
- (h) Protect the module from static , it may cause damage to the CMOS Gate Array IC.
- (i) Use finger-stalls with soft gloves in order to keep display clean during the incoming inspection and assembly process.
- (j) Do not disassemble the module.
- (k) Do not pull or fold the lamp wire.
- (l) Do not adjust the variable resistor which is located on the module.
- (m) Protection film for polarizer on the module shall be slowly peeled off just before use so that the electrostatic charge can be minimized.
- (n) Pins of I/F connector shall not be touched directly with bare hands.

12.2 Storage

- (a) Do not leave the module in high temperature, and high humidity for a long time. It is highly recommended to store the module with temperature from 0 to 35C and relative humidity of less than 70%.
- (b) Do not store the TFT-LCD module in direct sunlight.
- (c) The module shall be stored in a dark place. It is prohibited to apply sunlight or fluorescent light during the store.

12.3 Operation

- (a) Do not connect,disconnect the module in the "Power On" condition.
- (b) Power supply should always be turned on/off by the item 6.3 "Power on/off sequence"
- (c) Module has high frequency circuits. Sufficient suppression to the electromagnetic interference shall be done by system manufacturers. Grounding and shielding methods may be important to minimize the interference.
- (d) The cable between the back-light connector and its inverter power supply shall be a minimized length and be connected directly . The longer cable between the back-light and the inverter may cause lower luminance of lamp(CCFT) and may require higher startup voltage(Vs).

12.4 Others

- (a) Ultra-violet ray filter is necessary for outdoor operation.
- (b) Avoid condensation of water. It may result in improper operation or disconnection of electrode.
- (c) Do not exceed the absolute maximum rating value. (the supply voltage variation, input voltage variation, variation in part contents and environmental temperature, and so on)
Otherwise the module may be damaged.
- (d) If the module displays the same pattern continuously for a long period of time,it can be the situation when the image "Sticks" to the screen.
- (e) This module has its circuitry PCB's on the rear side and should be handled carefully in order not to be stressed.