



TO : China general

DATE : Oct. 11 , 2011

**SAMSUNG TFT-LCD**  
**MODEL NO. : LTN156AT19-W**

NOTE : Extension code [ - Wxx ]  
→ LTN156AT19- Wxx  
Surface type [ A/G ]

*Any modification of Spec is not allowed without SEC's permission*

**Application engineering part, Mobile Division**  
**Samsung Electronics Co., Ltd.**

**Samsung Secret**

**CONTENTS**

Revision History	----- ( 3 )
General Description	----- ( 4 )
1. Absolute Maximum Ratings	----- ( 5 )
1.1 Absolute Ratings of environment	
1.2 Electrical Absolute Ratings	
2. Optical Characteristics	----- ( 7 )
3. Electrical Characteristics	----- ( 10 )
3.1 TFT LCD Module	
3.2 Backlight Unit	
3.3 LED Driver	
4. Block Diagram	----- ( 13 )
4.1 TFT LCD Module	
4.2 LED Placement Structure	
5. Input Terminal Pin Assignment	----- ( 14 )
5.1 Input Signal & Power	
5.2 LVDS Interface	
5.3 Timing Diagrams of LVDS For Transmitting	
5.4 Pixel format	
6. Interface Timing	
6.1 Timing Parameters	----- ( 19 )
6.2 Timing Diagrams of interface Signal	
6.3 Power ON/OFF Sequence	
7. Outline Dimension	----- ( 222 )
8. Packing	----- ( 24 )
9. Markings & Others	----- ( 25 )
10. General Precautions	----- ( 27 )
11. EDID	----- ( 29 )

**Samsung Secret**

# REVISION HISTORY

Approval

Date	Revision No.	Page	Summary
Oct, 11. 2011	A00	All	The approval specification of 15.6" SMS HD was issued first.

**Samsung Secret**

**Doc.No.**

LTN156AT19-W

**Rev.No**

04-A00-G-111011

**Page**

3 / 31

## GENERAL DESCRIPTION

### DESCRIPTION

LTN156AT19 is a color active matrix TFT (Thin Film Transistor) liquid crystal display (LCD) that uses amorphous silicon TFT as switching devices.

This model is composed of a TFT LCD panel, a driver circuit and a backlight unit.

The resolution of a 15.6" contains 1366 x 768 pixels and can display up to 262,144 colors.

6 O'clock direction is the optimum viewing angle.

### FEATURES

- High contrast ratio
- HD(1366 x 768 pixels ) resolution
- Fast Response
- LED Back Light with embedded LED Driver
- DE (Data enable) only mode
- 3.3V LVDS Interface
- Onboard EEDID chip

### APPLICATIONS

- Notebook PC
- If the usage of this product is not for PC application, but for others, please contact SEC

## GENERAL INFORMATION

Item	Specification	Unit	Note
Display area	344.232 (H) x 193.536 (V) (15.6" diagonal)	mm	
Driver element	a-Si TFT active matrix		
Display colors	262,144		
Number of pixel	1366 * 768	pixel	
Pixel arrangement	RGB vertical stripe		
Pixel pitch	0.252 (H) x 0.252 (V) (TYP.)	mm	
Display Mode	Normally white		
Surface treatment	Haze 25%, Hardness 2H		A/G

**Samsung Secret**

## Mechanical Information

Item		Min.	Typ.	Max.	Unit	Note
Module size	Horizontal (H)	358.8	359.3	359.8	mm	
	Vertical (V)	209.0	209.5	210.0	mm	
	Depth (D)	-	-	4.0	mm	
Weight		-	-	430	g	

Note (1) Measurement condition of outline dimension  
. Equipment : Bernier Calipers  
. Push Force : 500g · f (minimum)

## 1. ABSOLUTE MAXIMUM RATINGS

### 1.1 ENVIRONMENTAL ABSOLUTE RATINGS

Item	Symbol	Min.	Max.	Unit	Note
Storage temperate	TSTG	-20	60	°C	(1)
Operating temperate (Temperature of glass surface)	TOPR	0	50	°C	(1)
Shock ( non-operating )	Snop	-	240	G	(2),(4)
Vibration (non-operating)	Vnop	-	2.41	G	(3),(4)

Note (1) Temperature and relative humidity range are shown in the figure below.  
95 % RH Max. ( $40\text{ °C} \geq T_a$ )  
Maximum wet - bulb temperature at  $39\text{ °C}$  or less. ( $T_a > 40\text{ °C}$ ) No condensation

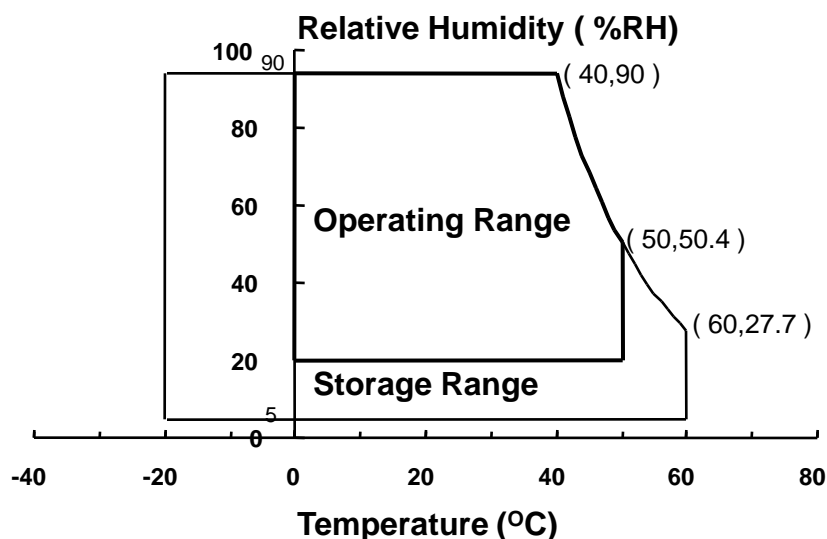

- (2) 2ms, half sine wave, one time for  $\pm X$ ,  $\pm Y$ ,  $\pm Z$ .
- (3) 5 - 500 Hz, random vibration, 30min for X, Y, Z.
- (4) At testing Vibration and Shock, the fixture in holding the Module to be tested have to be hard and rigid enough so that the Module would not be twisted or bent by the fixture.

**Samsung Secret**

## 1.2 ELECTRICAL ABSOLUTE RATINGS

## (1) TFT LCD MODULE

 $V_{DD} = 3.3V, V_{SS} = GND = 0V$ 

Item	Symbol	Min.	Max.	Unit	Note
Power Supply Voltage	$V_{DD}$	$V_{DD} - 0.3$	$V_{DD} + 0.3$	V	(1)
Logic Input Voltage	$V_{IN}$	$V_{DD} - 0.3$	$V_{DD} + 0.3$	V	(1)

Note (1) Within  $T_a$  ( $25 \pm 2 \text{ }^\circ\text{C}$ )

## (2) BACK-LIGHT UNIT

 $T_a = 25 \pm 2 \text{ }^\circ\text{C}$ 

Item	Symbol	Min.	Typ.	Max.	Unit	Note
LED Current	$I_L$	-	22	-	mArms	(1)
LED Voltage	$V_L$	-	3.2	-	V	(1)

Note 1) Permanent damage to the device may occur if maximum values are exceeded  
 Functional operation should be restricted to the conditions described under normal operating conditions.

## 2. OPTICAL CHARACTERISTICS

The following items are measured under stable conditions. The optical characteristics should be measured in a dark room or equivalent state with the methods shown in Note (5).  
Measuring equipment : TOPCON SR-3

\* Ta = 25 ± 2 °C, V<sub>DD</sub>=3.3V, fv= 60Hz, fdCLK = 70.7MHz, IF = 100% duty

Item	Symbol	Condition	Min.	Typ.	Max	Unit	Note
Contrast Ratio (5 Points)	CR	Normal Viewing Angle $\phi = 0$ $\theta = 0$	300	-	-	-	(1), (2), (5)
Response Time at Ta ( Rising + Falling )	T <sub>RT</sub>		-	16	25	msec	(1), (3)
Average Luminance of White (5 Points)	Y <sub>L,AVE</sub>		200	220	-	cd/m <sup>2</sup>	IF=100% duty (1), (4)
Color Chromaticity ( CIE )	Red		R <sub>X</sub>	Typ- 0.03	0.570	Typ +0.03	-
		R <sub>Y</sub>	0.340				
	Green	G <sub>X</sub>	0.330				
		G <sub>Y</sub>	0.560				
	Blue	B <sub>X</sub>	0.160				
		B <sub>Y</sub>	0.135				
	White	W <sub>X</sub>	0.313				
		W <sub>Y</sub>	0.329				
Viewing Angle	Hor.	$\theta_L$	CR ≥ 10 At center	40	45	-	Degrees
		$\theta_H$		40	45	-	
	Ver.	$\phi_H$		15	15	-	
		$\phi_L$		30	30-	-	
Color Gamut	CG	-	45	-	%		
13 Points White Variation	$\delta_L$	-	-	2.0	-	(6)	

**Samsung Secret**

Note 1) Definition of Viewing Angle : Viewing angle range( $10 \leq C/R$ )

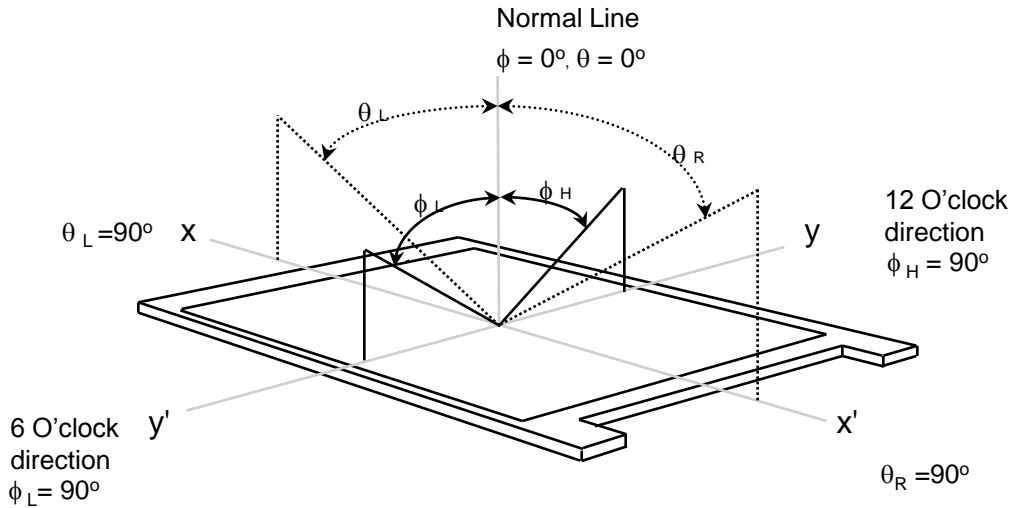

Note 2) Definition of Contrast Ratio (CR) : Ratio of gray max (Gmax) ,gray min (Gmin) at 5 points(4, 5, 7, 9, 10)

$$CR = \frac{CR(4) + CR(5) + CR(7) + CR(9) + CR(10)}{5}$$

Points : (4) , (5) , (7) , (9) , (10) at the figure of Note (6).

Note 3) Definition of Response time :

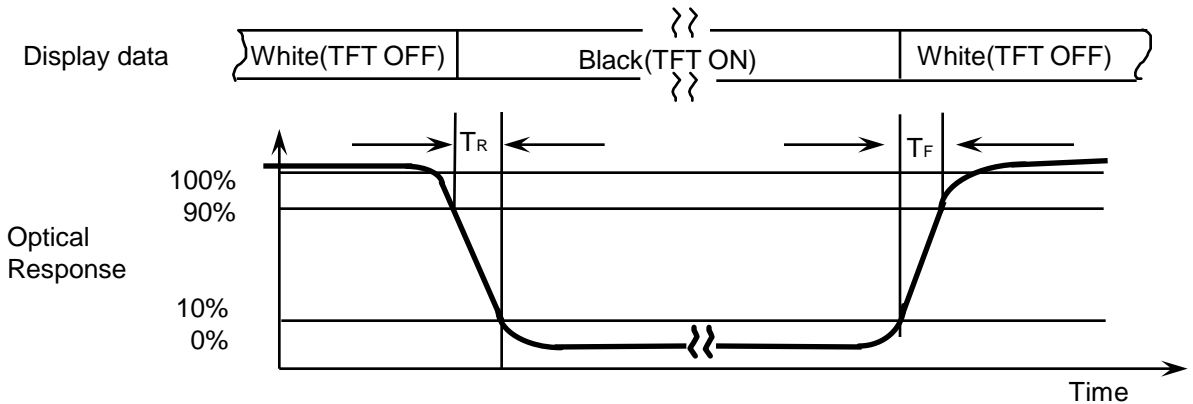

Note 4) Definition of Average Luminance of White : measure the luminance of white at 5 points.

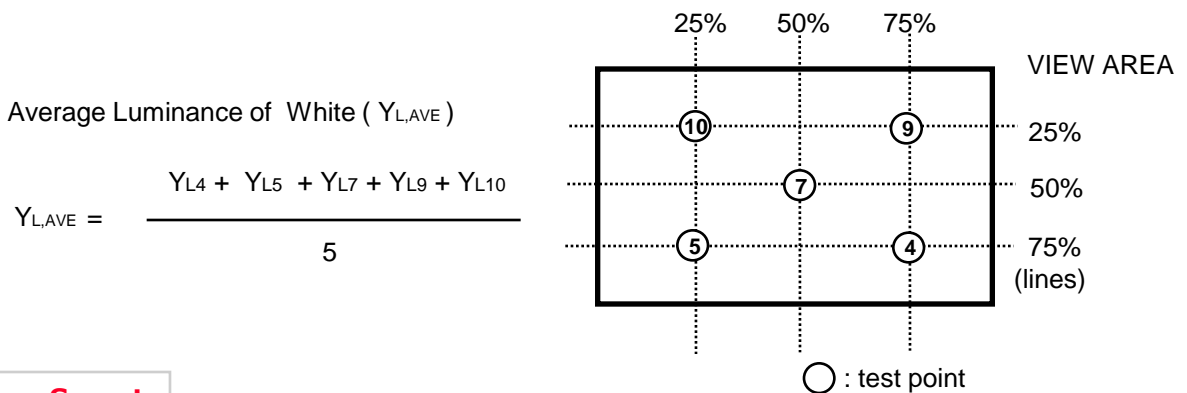



Note 5) After stabilizing and leaving the panel alone at a given temperature for 30 min , the measurement should be executed. Measurement should be executed in a stable, windless, and dark room. 30 min after lighting the backlight. This should be measured in the center of screen.  
 IF current : 22mA  
 Environment condition :  $T_a = 25 \pm 2 \text{ }^\circ\text{C}$

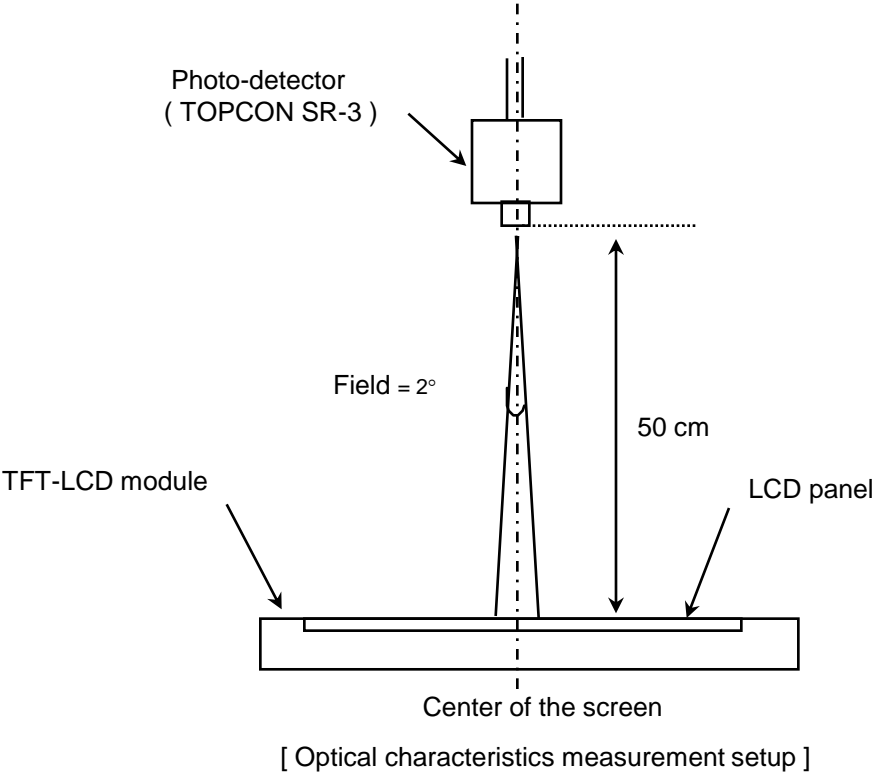

Note 6) Definition of 13 points white variation ( $\delta L$ ), CR variation( $C_{VER}$ ) [ ① ~ ⑬ ]

$$\delta L = \frac{\text{Maximum luminance of 13 points}}{\text{Minimum luminance of 13 points}}$$

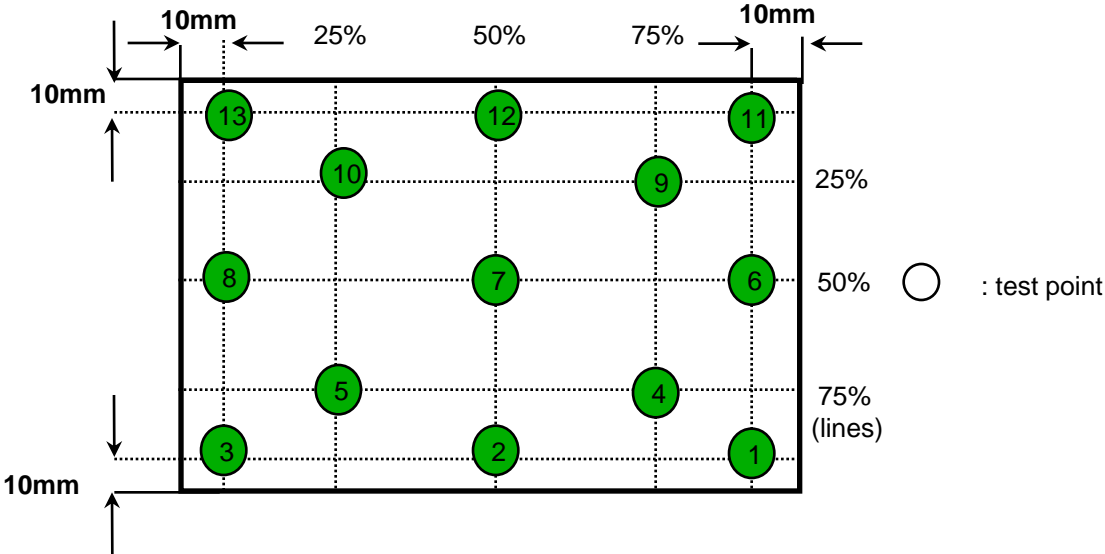

**Samsung Secret**

### 3. ELECTRICAL CHARACTERISTICS

Approval

#### 3.1 TFT LCD MODULE

Ta= 25 ± 2°C

Item	Symbol	Min.	Typ.	Max.	Unit	Note	
Voltage of Power Supply	V <sub>DD</sub>	3.0	3.3	3.6	V		
Differential Input Voltage for LVDS Receiver Threshold	High	V <sub>IH</sub>	-	-	+100	mV	V <sub>CM</sub> = +1.2V
	Low	V <sub>IL</sub>	-100	-	-	mV	
Vsync Frequency	f <sub>v</sub>	-	60	-	Hz		
Main Frequency	f <sub>DCLK</sub>	66.14	70.7	83.88	MHz	-	
Rush Current	I <sub>RUSH</sub>	-	-	1.5	A	(4)	
Current of Power Supply	White	IDD	-	230	-	mA	*a),b),c)
	Mosaic		-	230	-	mA	
	V.stripe		-	300	350	mA	

Note (1) Display data pins and timing signal pins should be connected.( GND = 0V )

(2) f<sub>v</sub> = 60HZ, f<sub>DCLK</sub> = 72.33MHZ, V<sub>DD</sub> = 3.3V , DC Current.

(3) Power dissipation pattern

\*a) White Pattern

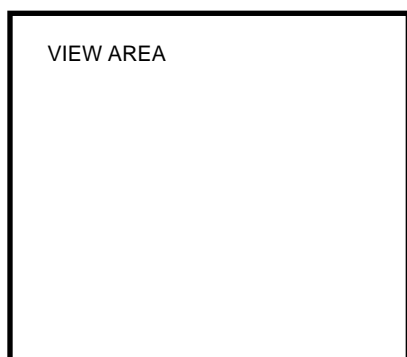

\*b) Mosaic Pattern

Display Brightest Gray Level →  
 Display Darkest Gray Level →

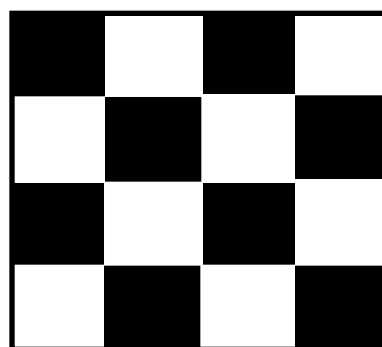

Samsung Secret

\*c) 1dot Vertical stripe pattern

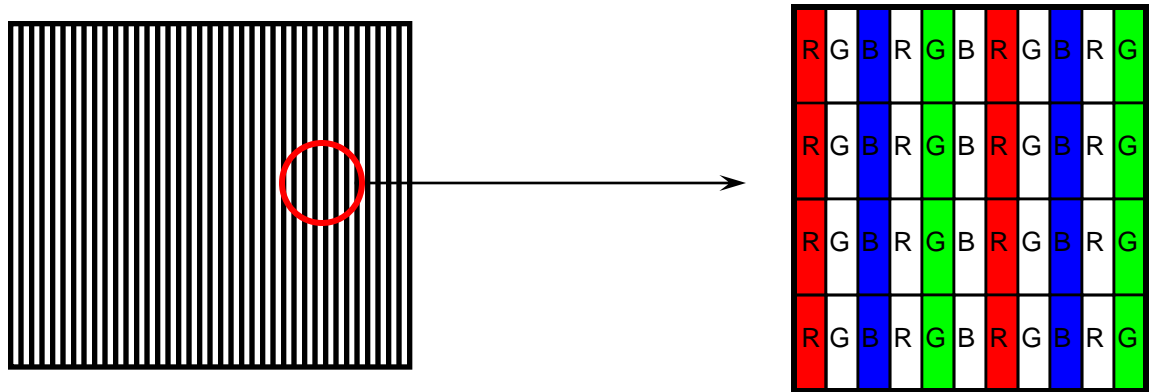

4) Rush current measurement condition

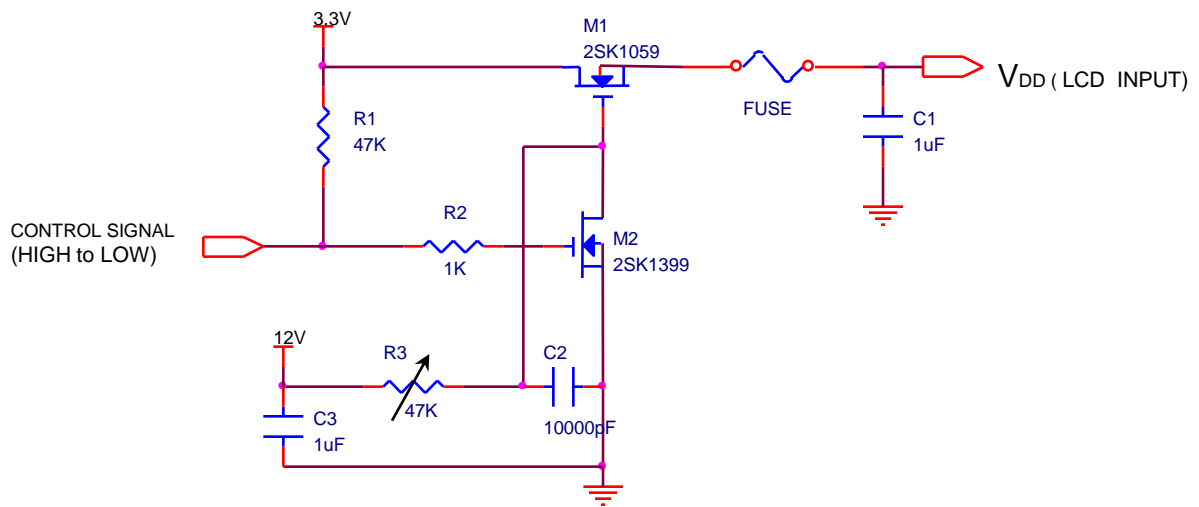

V<sub>DD</sub> rising time is 470us

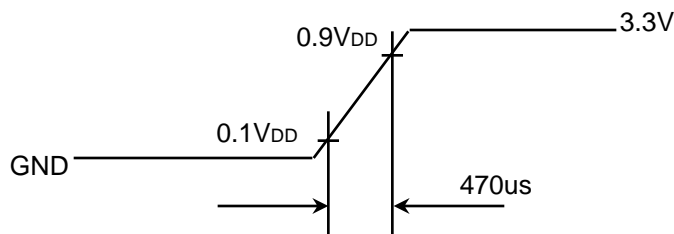

**Samsung Secret**

### 3.2 LED Driver

- On board LED Driver (Intersil)

Ta= 25 ± 2 °C

Item-	Symbol	Min.	Typ.	Max.	Unit	Note
Input Voltage	V <sub>in</sub>	7	12	20	V	-
Input Current	I	-	270	-	mA	-
power consumption	P	-	0.9	1.0	W	@ 60nit
		-	3.3	3.5	W	@ Max
EN control level	ON	2.0	-	-	V	
	OFF	-	-	0.8	V	
PWM control level	ON	2.0	-	-	V	
	OFF	-	-	0.8	V	
PWM Control Duty Ratio	D	5	-	100	%	PWM freq : 200Hz~10KHz
		10	-	100		PWM freq : 1KHz~10KHz
External PWM Dimming Control Frequency (BLIM)	F <sub>BLIM</sub>	0.2	1	10	kHz	
Operating Life Time	Hr	10,000	-	-	Hour	

Note (1) Life time (Hr) of LEDs can be defined as the time in which it continues to operate under the condition Ta= 25 ± 2 °C and IF = 22mA until one of the following event occurs.  
When the brightness becomes 50% or lower than the original.

### 3.3 BACK-LIGHT UNIT

Ta= 25 ± 2 °C

Item	Symbol	Min.	Typ.	Max.	Unit	Note
LED Forward Current	IF	-	22	-	mA	
LED Forward Voltage	VF	3.0	3.2	3.4	V	
LED Array Voltage	VP	-	36	-	V	
BL consumption	P	-	-	3.3	W	@ MAX

**Samsung Secret**

## 4. BLOCK DIAGRAM

### 4.1 TFT LCD Module

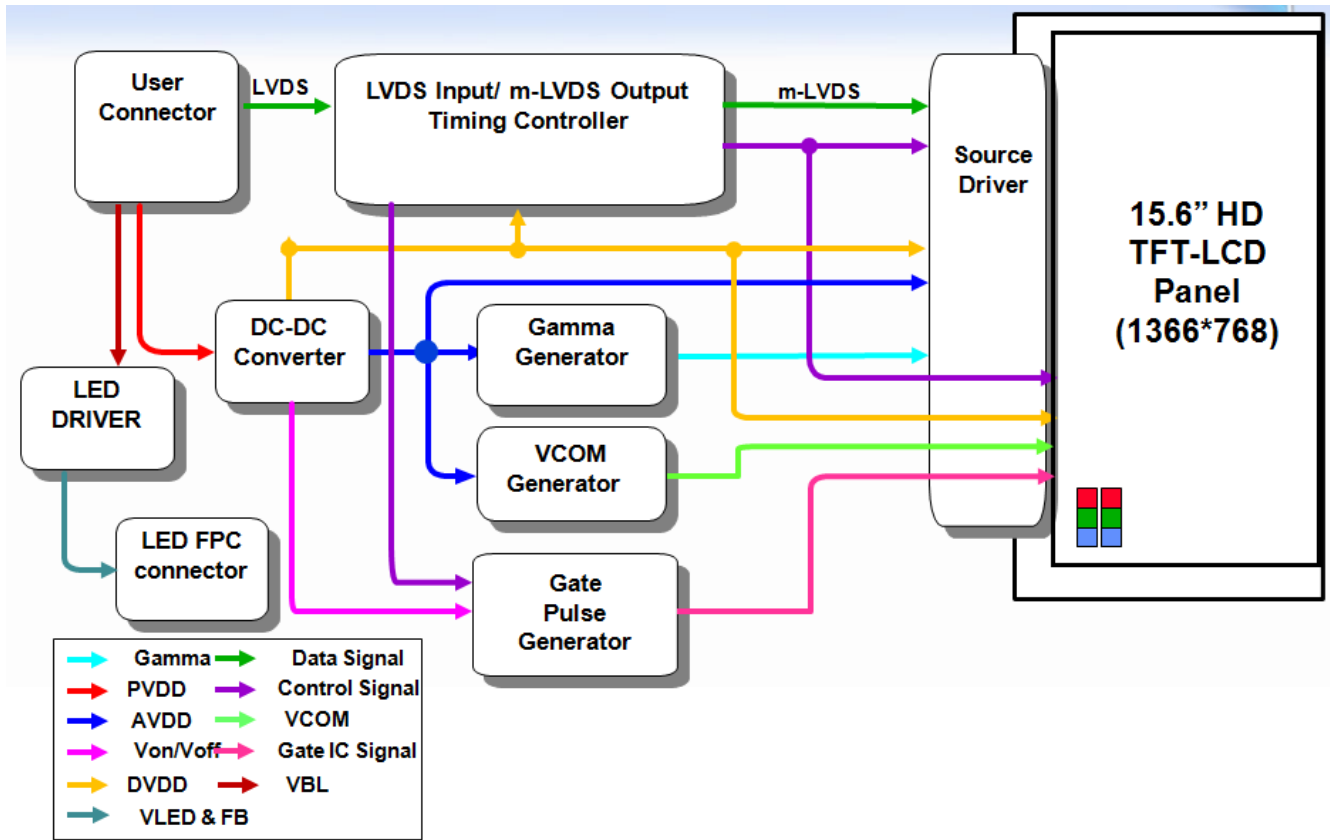

### 4.2 LED placement structure

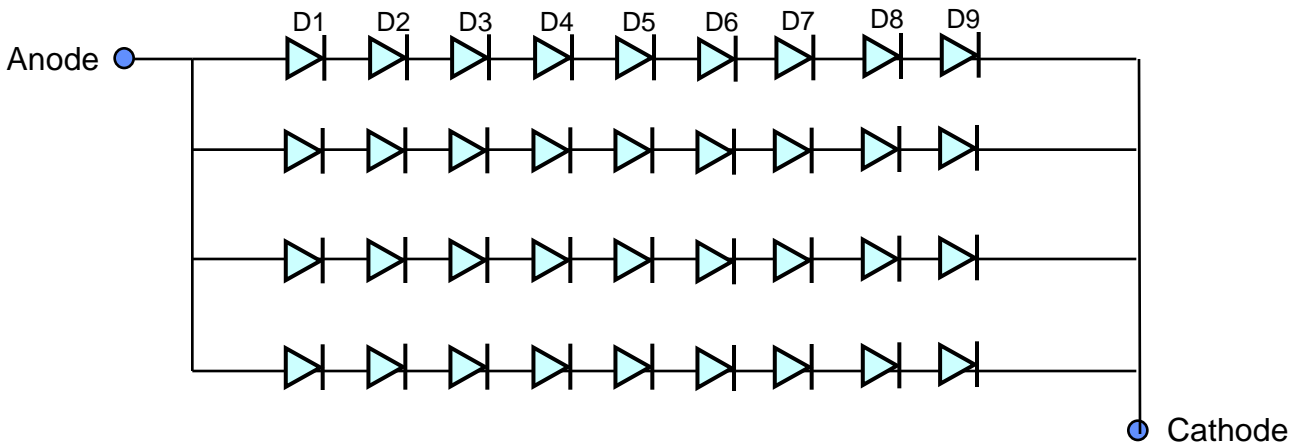

Samsung Secret

## 5. INPUT TERMINAL PIN ASSIGNMENT

Approval

### 5.1. Input Signal & Power (LVDS, Connector : I-PEX 20455-#40E-## or equivalent )

No.	Symbol	Function	Polarity	Remarks
1	NC	No Connection (Reserved for supplier)		
2	AVDD	Power Supply 3.3V (typical)		
3	AVDD	Power Supply 3.3V (typical)		
4	DVDD	DDC 3.3V power		
5	NC	No Connection		
6	SCL	DDC Clock		
7	SDA	DDC data		
8	RIN0-	-LVDS differential data input (R0-R5, G0)	Negative	
9	RIN0+	+LVDS differential data input (R0-R5, G0)	Positive	
10	GND	Ground		
11	RIN1-	-LVDS differential data input (G1-G5, B0-B1)	Negative	
12	RIN1+	+LVDS differential data input (G1-G5, B0-B1)	Positive	
13	GND	Ground		
14	RIN2-	-LVDS differential data input (B2-B5, HS, VS, DE)	Negative	
15	RIN2+	+LVDS differential data input (B2-B5, HS, VS, DE)	Positive	
16	GND	Ground		
17	CLK-	-LVDS differential clock input	Negative	
18	CLK+	+LVDS differential clock input	Positive	
19	GND	Ground		
20	NC	No connection		
21	NC	No connection		
22	GND	Ground		
23	NC	No connection		
24	NC	No connection		
25	GND	Ground		
26	NC	No connection		
27	NC	No connection		
28	GND	Ground		
29	NC	No Connect		
30	NC	No Connect		

**Samsung Secret**

No.	Symbol	Function	Polarity	Remarks
31	VSSLED	Ground – LED		
32	VSSLED	Ground – LED		
33	VSSLED	Ground – LED		
34	NC	No Connect		
35	PWM	System PWM Signal Input (+3.3V Swing)		
36	LED_EN	LED enable pin (+3.3V Input)		
37	NC	No Connect		
38	VDDLED	LED power		
39	VDDLED	LED power		
40	VDDLED	LED power		

**Samsung Secret**

## 5.2 LVDS Interface

### 5.2.1 LVDS DC Input

ITEM	SYMBOL	MIN.	TYP.	MAX.	UNIT	NOTE
LVDS Differential Voltage	VID	200	-	600	mV	
Input Common Mode Voltage	$V_{CM}$	0.4	1.2	1.7	V	

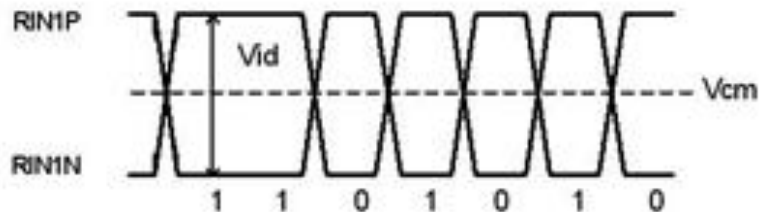

### 5.2.1 LVDS AC Input

ITEM	SYMBOL	MIN.	TYP.	MAX.	UNIT	NOTE	
LVDS input Clock Frequency	$F_{CLK\_LVDS}$	30		100	Mhz		
LVDS RX skew Right margin	100MHz	$T_{RSRM}$	-	-	270	ps	(1),(2)
	50MHz		-	-	700	ps	(1),(2)
LVDS RX skew Left margin	100MHz		-270	-	-	ps	(1),(2)
	50MHz		-700	-	-	ps	(1),(2)
Maximum deviation of LVDS input clock during SSCG	$F_{CLK\_DEV}$	-	-	$\pm 3$	%	(3)	
Modulating frequency of LVDS input clock during SSCG	$F_{CLK\_MOD}$	30	-	300	KHz	(3)	

Note (1) : LVDS Receiver Skew (Strobe) Margin

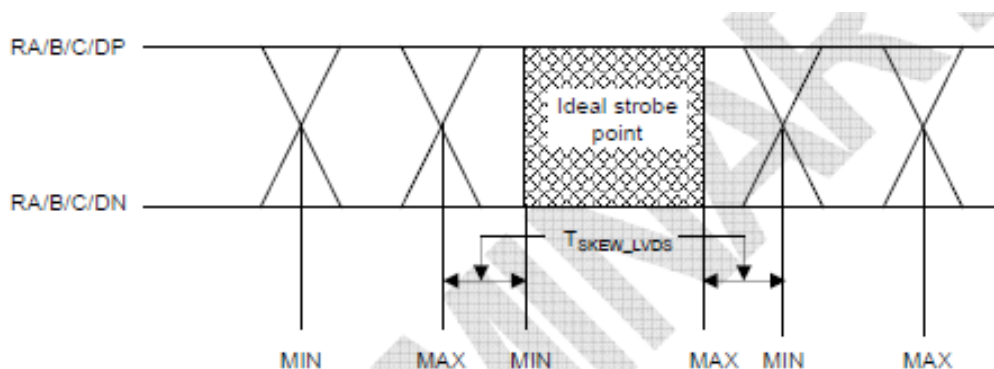

**Samsung Secret**



### 5.3 Timing Diagrams of LVDS For Transmission

#### LVDS Receiver : Integrated T-con

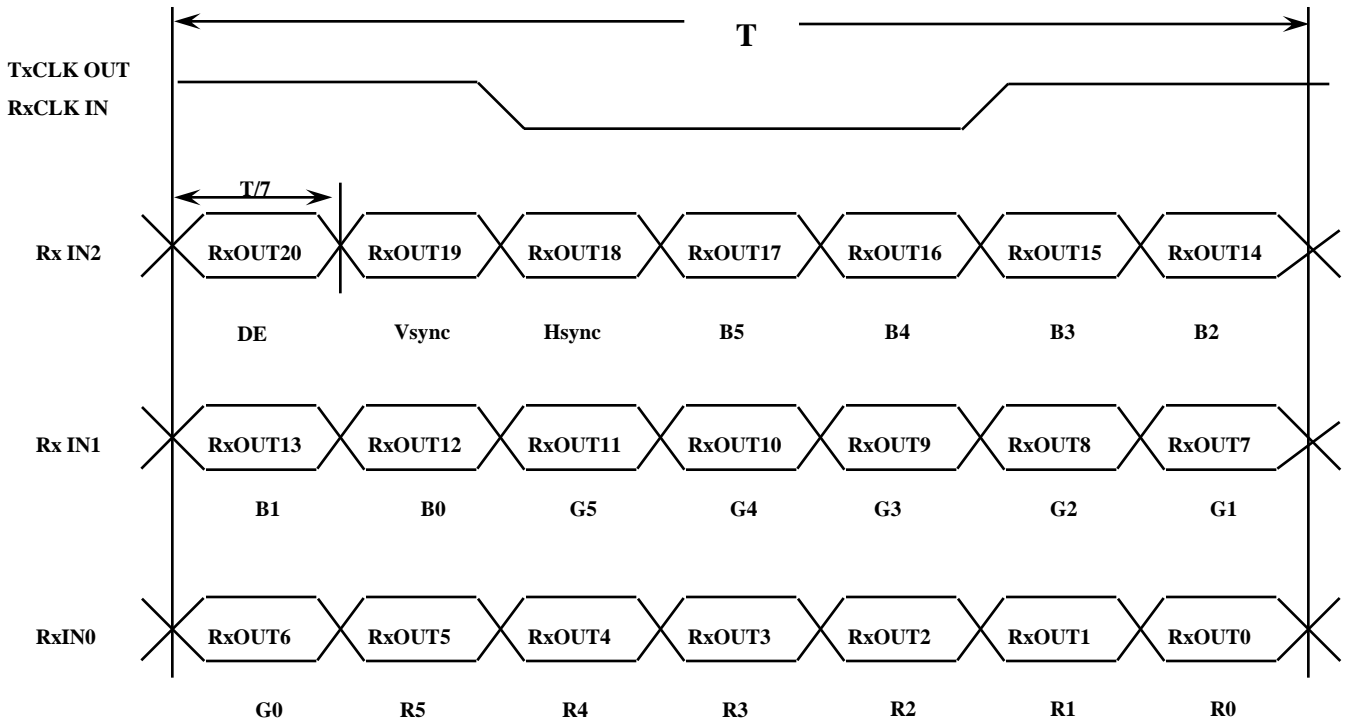

**Samsung Secret**

### 5.4 Pixel Format in the display

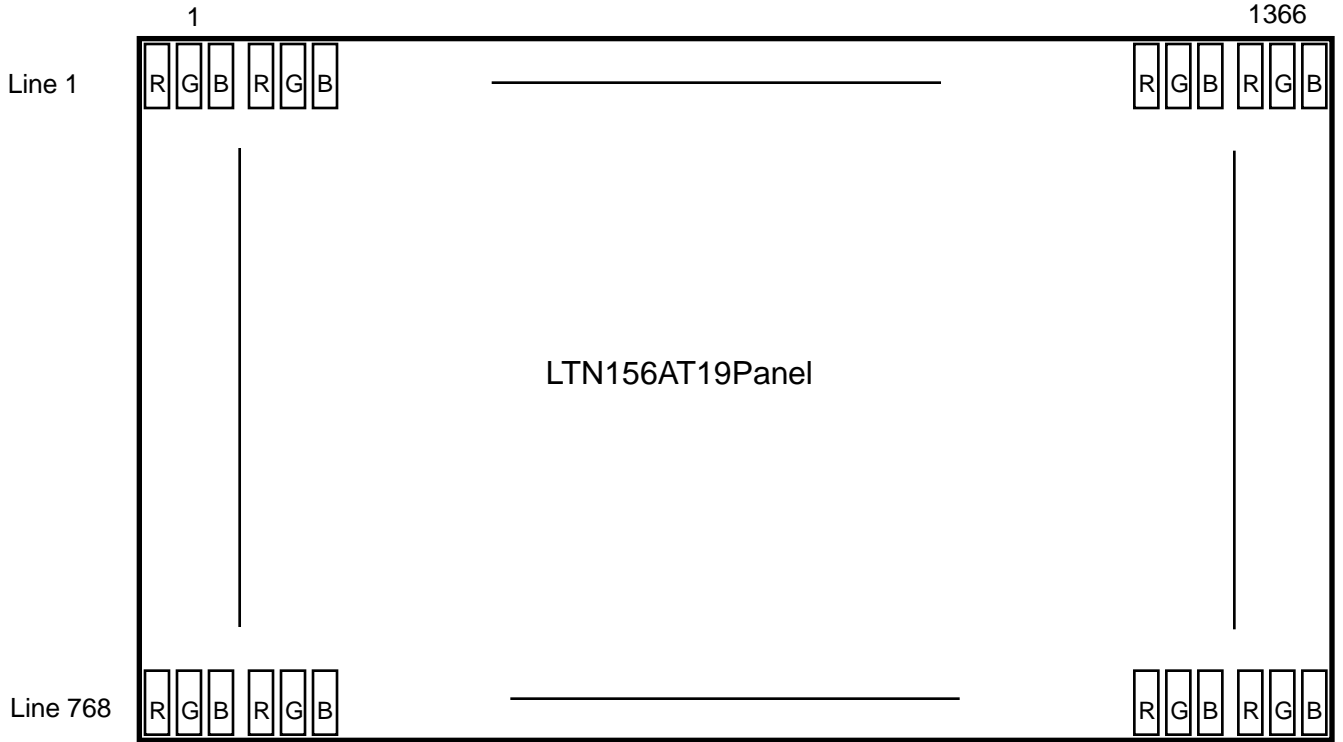

**Samsung Secret**

## 6. INTERFACE TIMING

### 6.1 Timing Parameters

Signal	Item	Symbol	Min.	Typ.	Max.	Unit	Note
Frame Frequency	Cycle	TV	773	790	810	Lines	
Vertical Active Display Term	Display Period	TVD	-	768	-	Lines	
One Line Scanning Time	Cycle	TH	1426	1526	1726	Clocks	
Horizontal Active Display Term	Display Period	THD	-	1366	-	Clocks	

### 6.2 Timing diagrams of interface signal

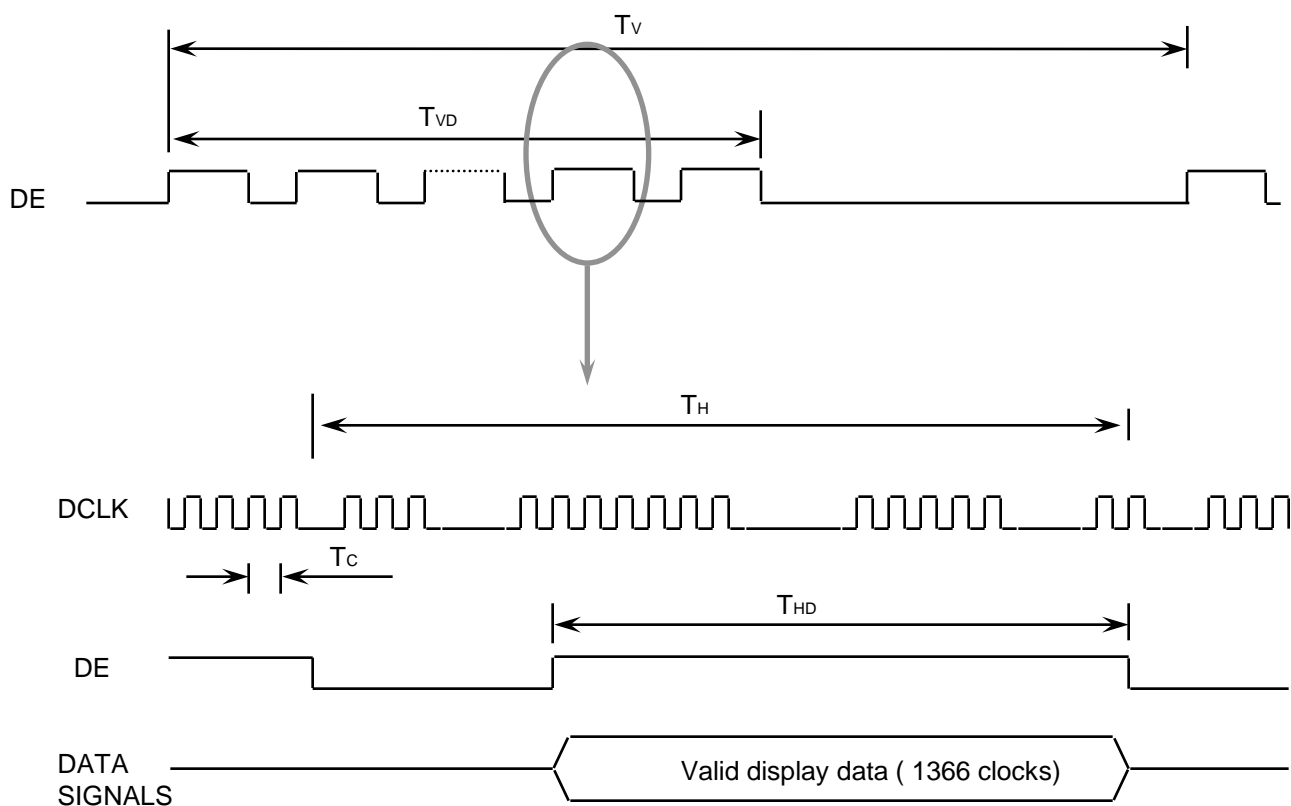

**Samsung Secret**

### 6.3 Power ON/OFF Sequence

: To prevent a latch-up or DC operation of the LCD module, the power on/off sequence should be as the diagram below.

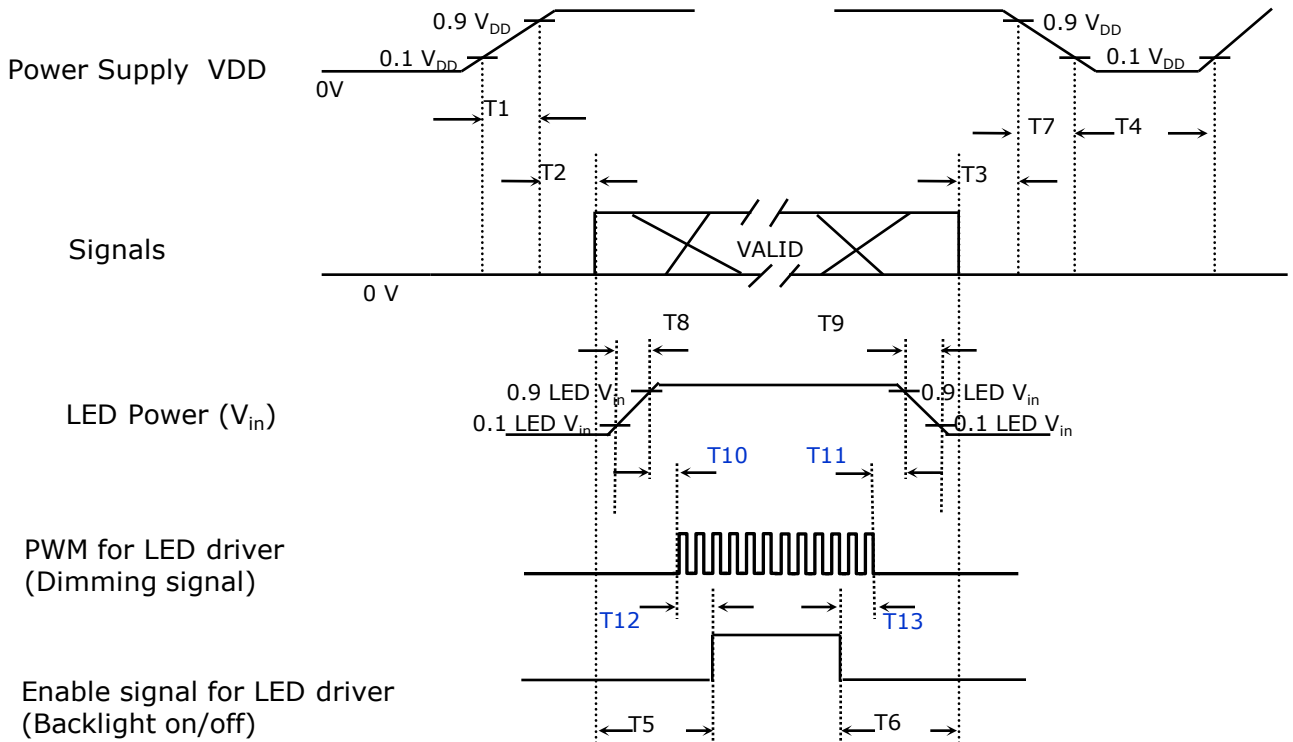

### Power ON/OFF Sequence

Timing (ms)	Remarks
$0.5 < T1 \leq 10$	V <sub>DD</sub> rising time from 10% to 90%
$0 < T2 \leq 50$	Delay from V <sub>DD</sub> to valid data at power ON
$0 < T3 \leq 50$	Delay from valid data OFF to V <sub>DD</sub> OFF at power Off
$500 \leq T4$	V <sub>DD</sub> OFF time for Windows restart
$300 \leq T5$	Delay from valid data to B/L enable at power ON
$200 \leq T6$	Delay from valid data off to B/L disable at power Off
$0 < T7 \leq 10$	V <sub>DD</sub> falling time from 90% to 10%
$0.5 < T8 \leq 10$	LED V <sub>in</sub> rising time from 10% to 90%
$0.5 < T9 \leq 10$	LED V <sub>in</sub> falling time from 90% to 10%
$0 \leq T10$	Delay from LED driver Vin rising time 90% to PWM ON
$0 \leq T11$	Delay from PWM Off to LED driver Vin falling time 10%, Must Keep rule
$0 \leq T12$	Delay from PWM ON to B/L Enable ON, Must Keep rule
$0 \leq T13$	Delay from B/L Enable Off to PWM Off

### Power Sequence & Timing Parameters

**Samsung Secret**

## NOTE.

- (1) The supply voltage of the external system for the module input should be the same as the definition of  $V_{DD}$ .
- (2) Apply the lamp voltage within the LCD operation range. When the back-light turns on before the LCD operation or the LCD turns off before the back-light turns off, the display may momentarily become white.
- (3) In case of  $V_{DD} = \text{off level}$ , please keep the level of input signals on the low or keep a high impedance.
- (4)  $T_4$  should be measured after the module has been fully discharged between power off and on period.
- (5) Interface signal shall not be kept at high impedance when the power is on.

## 7. Mechanical Outline Dimension

Approval

Refer to the next page

**Samsung Secret**

**Doc.No.**

LTN156AT19-W

**Rev.No**

04-A00-G-111011

**Page**

22 / 31

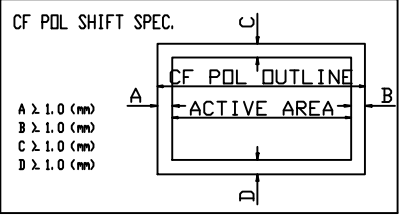
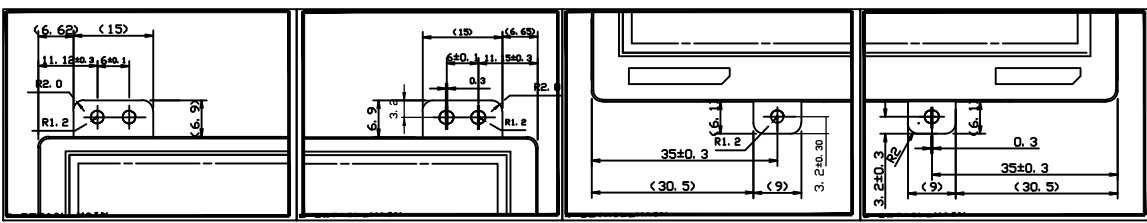
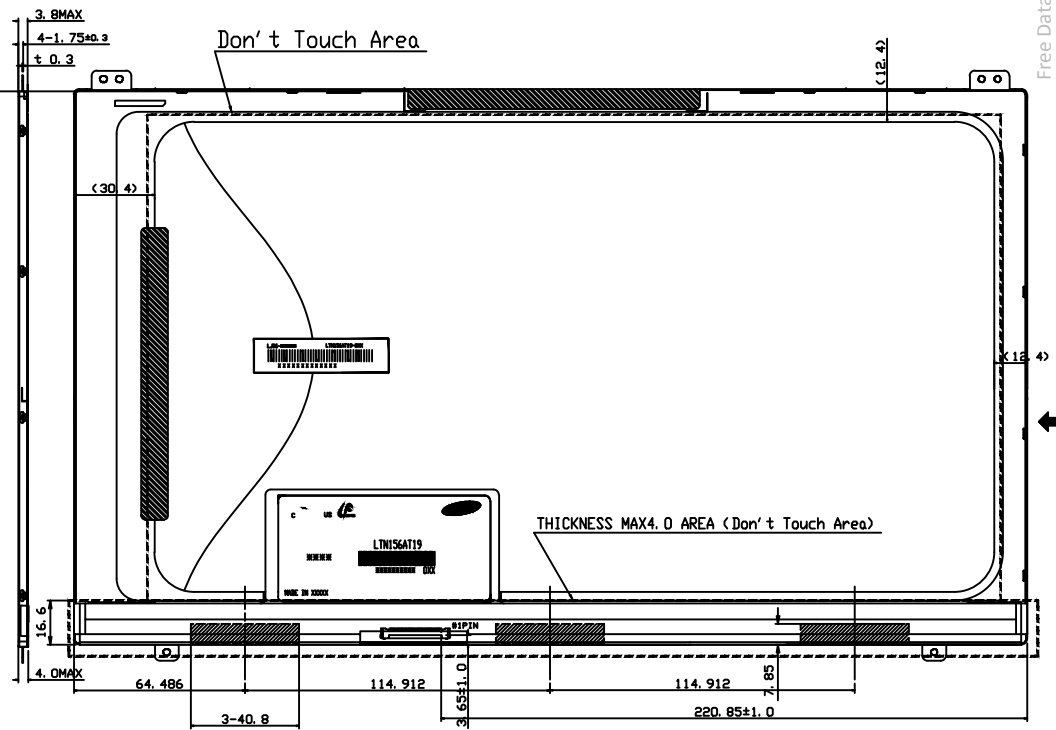
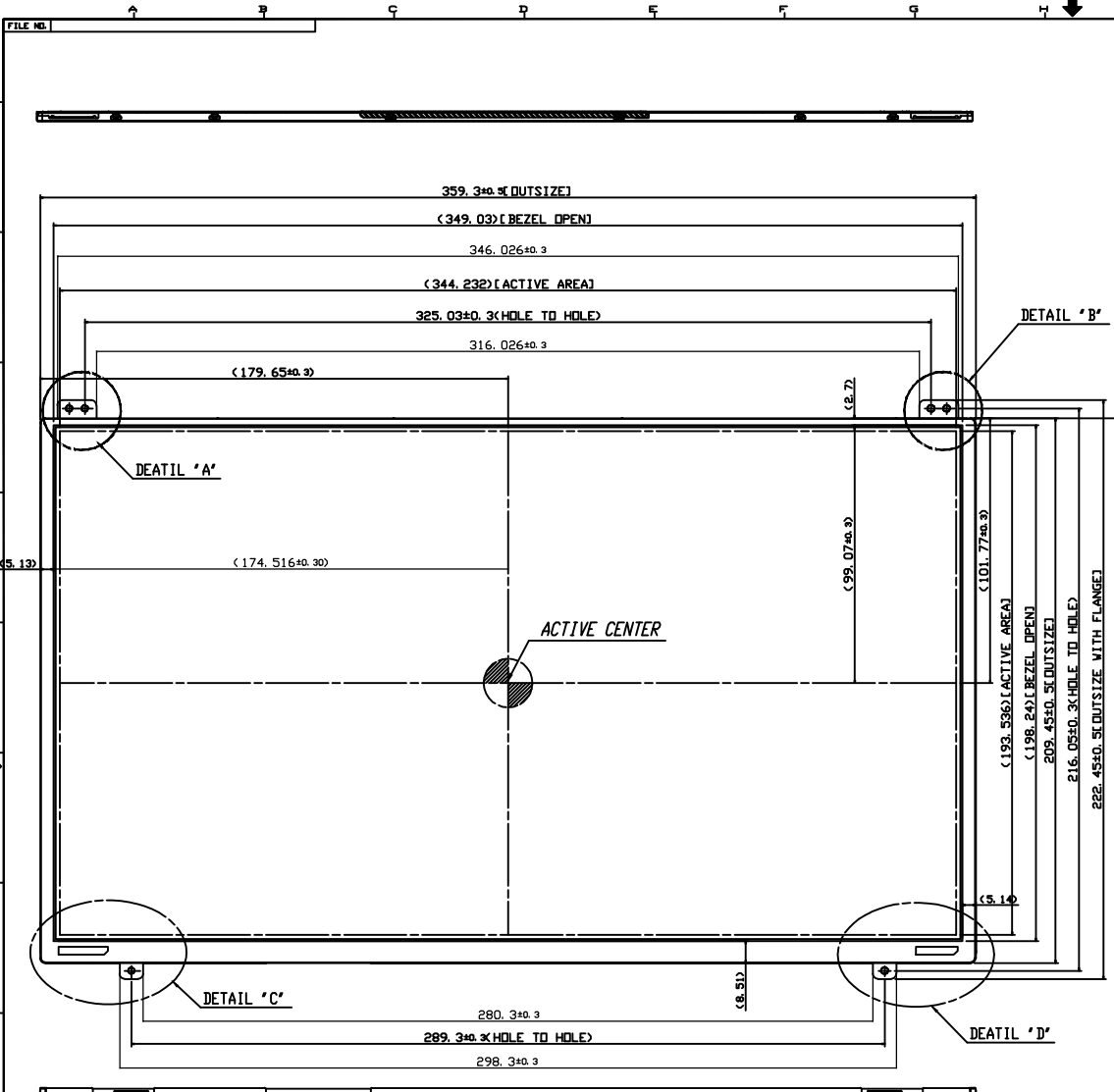

- \* NOTE**
1. SIGNAL INTERFACE CONNECTOR TO BE SPECIFIED AS BELOW.  
- PART NO./MAKER : 20455-040E-02R / I-PEX
  2. THICKNESS MEASURING FORCE : 750gf
  3. WEIGHT : 420g MAX
  4. In order to avoid IC damage, it is not allow that overlapping of cables or antennas, camera, WLAN, WWAN over these CDF location

Z00-01-000

GENERAL TOLERANCE				REV		DATE		DESCRIPTION OF REVISION		REASON		CHK'D BY	
STEP	LEVEL	COND. P	LEVEL	NO.	DATE	BY	DATE	BY	DATE	BY	DATE	BY	
1	0.1	0.05	0.05	1	10.10.07	M. C. LEE	10.10.07	J. S. DK					
2	0.1	0.05	0.05	2	10.10.07	M. C. LEE	10.10.07	J. S. DK					
3	0.1	0.05	0.05	3	10.10.07	M. C. LEE	10.10.07	J. S. DK					
4	0.1	0.05	0.05	4	10.10.07	M. C. LEE	10.10.07	J. S. DK					
5	0.1	0.05	0.05	5	10.10.07	M. C. LEE	10.10.07	J. S. DK					
6	0.1	0.05	0.05	6	10.10.07	M. C. LEE	10.10.07	J. S. DK					
7	0.1	0.05	0.05	7	10.10.07	M. C. LEE	10.10.07	J. S. DK					
8	0.1	0.05	0.05	8	10.10.07	M. C. LEE	10.10.07	J. S. DK					

MODEL NAME	LTN156AT19-T01	CHG'D BY	
PART/SHEET NAME	OUTLINE DIMENSION	SHEET	1/1
SPEC. NO.		VER.	000
SAMSUNG ELECTRONICS			
CODE NO.			

## 8. PACKING

Approval

### 1. CARTON(Internal Package)

#### (1) Packing Form

Corrugated fiberboard box and corrupad form as shock absorber

#### (2) Packing Method



Note 1) Total Weight : Approximately 20 kg

2) Acceptance number of piling : 36 sets

3) Carton size : 469(W) × 373(D) × 347(H)

**Samsung Secret**



(3)Packing Material

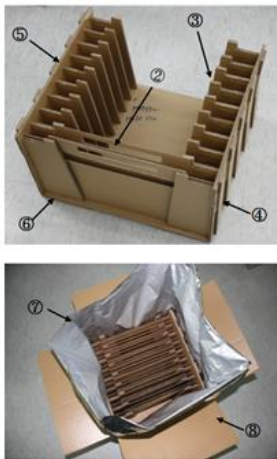

Lev	No	Part Name	Q'TY	Flute Type	Material
0	0	ASSY PACKING BOX	1		
1	1	PAD_TOP	1	B	
1	2	TRAY	9	E	
1	3	RIB	10	BB	
1	4	Protector Body	1	BB	
1	5	PAD_SIDE	1	BB	
1	6	PAD_BOTTOM	1	BB	
1	7	AL Bag	1		AL + PET
1	8	OUT BOX	1	A	

9. MARKINGS & OTHERS

A nameplate bearing followed by is affixed to a shipped product at the specified location on each product.

(1)Parts number : LTN156AT19

(2)Revision code : 3 letters

(3)Lot number : X X X X XXX XX X **Wxx**

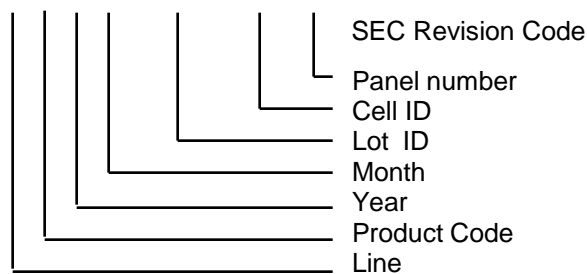

(5) Nameplate Indication

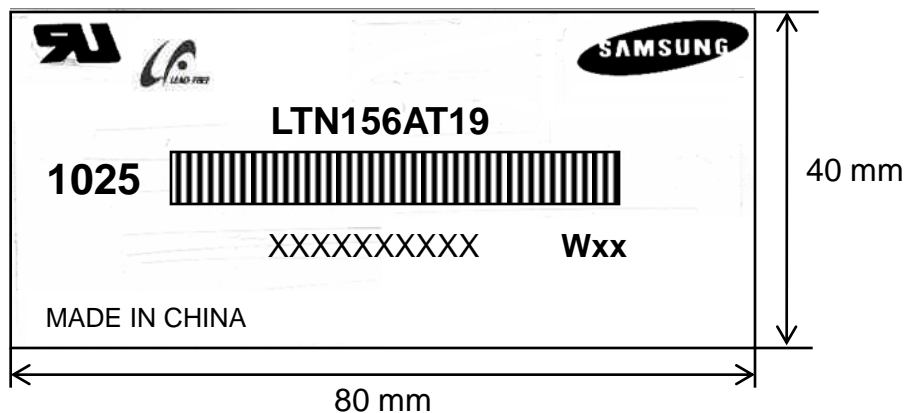

Parts name : LTN156AT19  
 Lot number : XXXXXXXXXXXX  
 Inspected work week : 1025(2010 year, 25nd week)

**Samsung Secret**

High voltage caution label

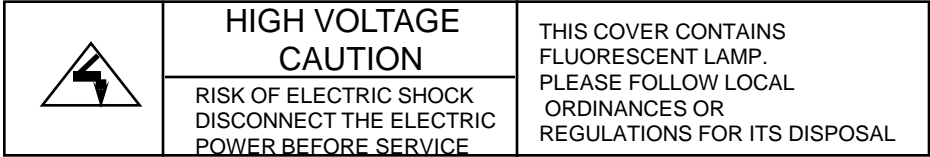

10mm High voltage caution

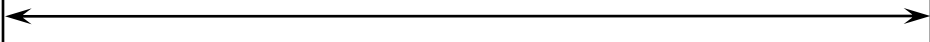

70mm

(6) Packing small box attach

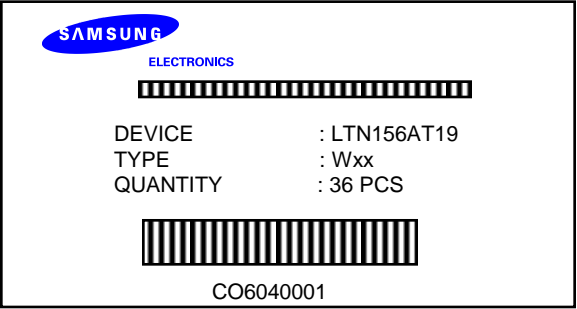

## 10. GENERAL PRECAUTIONS

Approval

### 1. Handling

- (a) When the module is assembled, It should be attached to the system firmly using every mounting holes. Be careful not to twist and bend the modules.
- (b) Refrain from strong mechanical shock and / or any force to the module. In addition to damage, this may cause improper operation or damage to the module and CCFT back-light.
- (c) Note that polarizers are very fragile and could be easily damaged. Do not press or scratch the surface harder than a HB pencil lead.
- (d) Wipe off water droplets or oil immediately. If you leave the droplets for a long time, Staining and discoloration may occur.
- (e) If the surface of the polarizer is dirty, clean it using some absorbent cotton or soft cloth.
- (f) The desirable cleaners are water, IPA (Isopropyl Alcohol) or Hexane. Do not use Ketone type materials(ex. Acetone), Ethyl alcohol, Toluene, Ethyl acid or Methyl chloride. It might permanent damage to the polarizer due to chemical reaction.
- (g) If the liquid crystal material leaks from the panel, it should be kept away from the eyes or mouth . In case of contact with hands, legs or clothes, it must be washed away thoroughly with soap.
- (h) Protect the module from static , it may cause damage to the C-MOS Gate Array IC.
- (i) Use fingerstalls with soft gloves in order to keep display clean during the incoming inspection and assembly process.
- (j) Do not disassemble the module.
- (k) Do not pull or fold the lamp wire.
- (l) Do not adjust the variable resistor which is located on the back side.
- (m) Protection film for polarizer on the module shall be slowly peeled off just before use so that the electrostatic charge can be minimized.
- (n) Pins of I/F connector shall not be touched directly with bare hands.

**Samsung Secret**

## 2. STORAGE

- (a) Do not leave the module in high temperature, and high humidity for a long time. It is highly recommended to store the module with temperature from 5 to 40 °C and relative humidity of less than 70%.
- (b) Do not store the TFT-LCD module under the direct sunlight.
- (c) The module shall be stored in a dark place. It is prohibited to apply sunlight or fluorescent light during storage.
- (d) Storage period is recommended not to exceed 1 year.

## 3. OPERATION

- (a) Do not connect, disconnect the module in the “ Power On” condition.
- (b) Power supply should always be turned on/off by following item 6.3 “ Power on/off sequence “.
- (c) Module has high frequency circuits. Sufficient suppression to the electromagnetic interference shall be done by system manufacturers. Grounding and shielding methods may be important to minimize the interference.
- (d) The standard limited warranty is only applicable when the module is used for general notebook applications. If used for purposes other than as specified, SEC is not to be held reliable for the defective operations. It is strongly recommended to contact SEC to find out fitness for a particular purpose.

## 4. OTHERS

- (a) Ultra-violet ray filter is necessary for outdoor operation.
- (b) Avoid condensation of water. It may result in improper operation or disconnection of electrode.
- (c) Do not exceed the absolute maximum rating value. ( the supply voltage variation, input voltage variation, variation in part contents and environmental temperature, so on) Otherwise the module may be damaged.
- (d) If the module displays the same pattern continuously for a long period of time, it can be the situation when the image “sticks” to the screen.
- (e) This module has its circuitry PCB's on the rear side and should be handled carefully in order not to be stressed.

**Samsung Secret**

# 11. EDID

Approval

Address (HEX)	FUNCTION	Value	BIN	DEC	ASCII or Data	Notes
		HEX				
00	Header	00	00000000	0		EDID Header
01		FF	11111111	255		
02		FF	11111111	255		
03		FF	11111111	255		
04		FF	11111111	255		
05		FF	11111111	255		
06		FF	11111111	255		
07		00	00000000	0		
08	ID Manufacturer Name	4C	01001100	76	S	3 character ID
09		A3	10100011	163	E C	"SEC"
0A	ID Product Code	4A	01001010	74	[J]	
0B		32	00110010	50	[2]	
0C	32-bit serial no.	00	00000000	0		
0D		00	00000000	0		
0E		00	00000000	0		
0F		00	00000000	0		
10	Week of manufacture	00	00000000	0		
11	Year of manufacture	15	00010101	21	2011	2011
12	EDID Structure Ver.	01	00000001	1	1	EDID Ver. 1.0
13	EDID revision #	03	00000011	3	3	EDID Rev. 3
14	Video input definition	80	10000000	128		
15	Max H image size	22	00100010	34	34	34 cm(approx)
16	Max V image size	13	00010011	19	19	19 cm(approx)
17	Display Gamma	78	01111000	120	2.2	Gamma 2.2
18	Feature support	0A	00001010	10		
19	Red/green low bits	09	00001001	9		01000010
1A	Blue/white low bits	25	00100101	37		11010101
1B	Red x/ high bits	92	10010010	146	0.570	Red x0.587= 10011000
1C	Red y	57	01010111	87	0.340	Red y0.344= 01010111
1D	Green x	54	01010100	84	0.330	Green x0.320= 01010010
1E	Green y	8F	10001111	143	0.560	Green y0.541= 10001100
1F	Blue x	29	00101001	41	0.160	Blue x0.155= 00100111
20	Blue y	22	00100010	34	0.135	Blue y0.130= 00100001
21	White x	50	01010000	80	0.313	White x0.313= 01010000
22	White y	54	01010100	84	0.329	White y0.329= 01010100
23	Established timing 1	00	00000000	0		601.088
24	Established timing 2	00	00000000	0		
25	Established timing 3	00	00000000	0		
26	Standard timing #1	01	00000001	1		not used
27		01	00000001	1		
28	Standard timing #2	01	00000001	1		not used
29		01	00000001	1		

**Samsung Secret**

2A	Standard timing #3	01	00000001	1		not used
2B		01	00000001	1		
2C	Standard timing #4	01	00000001	1		not used
2D		01	00000001	1		
2E	Standard timing #5	01	00000001	1		not used
2F		01	00000001	1		
30	Standard timing #6	01	00000001	1		not used
31		01	00000001	1		
32	Standard timing #7	01	00000001	1		not used
33		01	00000001	1		
34	Standard timing #8	01	00000001	1		not used
35		01	00000001	1		
36	Detailed timing/monitor descriptor #1	9E	10011110	158	70.7	Main clock
37		1B	00011011	27		
38		56	01010110	86	1366	Hor active
39		78	01111000	120	120	Hor blanking
3A		50	01010000	80		4bit : 4bit
3B		00	00000000	0	768	Vertical active
3C		18	00011000	24	24	Vertical blanking
3D		30	00110000	48		4bit : 4bit
3E		30	00110000	48	48	Hor sync. Offset
3F		20	00100000	32	32	H sync. Width
40		25	00100101	37	2	V sync. Offset
					5	V sync. Width
41		00	00000000	0		2bit : 2bit :2bit :2bit
42		58	01011000	88	344	H image size
43		C2	11000010	194	194	V image size
44		10	00010000	16		
45		00	00000000	0		No Horizontal Border
46		00	00000000	0		No Vertical Border
47		19	00011001	25		
48		Detailed timing/monitor descriptor #2	00	00000000	0	
49	00		00000000	0		
4A	00		00000000	0		
4B	0F		00001111	15		
4C	00		00000000	0		
4D	00		00000000	0		Value=HSPWmin / 2
4E	00		00000000	0		Value=HSPWmax / 2
4F	00		00000000	0		Value=Thbpmin / 2
50	00		00000000	0		Value=Thbpmax / 2
51	00		00000000	0		Value=VSPWmin / 2
52	00		00000000	0		Value=VSPWmax / 2
53	00		00000000	0		Value=TVbpmin / 2
54	00		00000000	0		Value=TVbpmax / 2
55	23		00100011	35		Thpmin=value*2 + HA pixelclks
56	87		10000111	135		Thpmax=value*2 + HA pixelclks
57	02		00000010	2		Tvpmin=value*2 + VA lines
58	64	01100100	100		Tvpmax=value*2 + VA lines	
59	01	00000001	1		Module revision	

Samsung Secret

5A	Detailed timing/monitor descriptor #3	00	00000000	0		ASCII Data String Tag
5B		00	00000000	0		
5C		00	00000000	0		
5D		FE	11111110	254		
5E		00	00000000	0		
5F		53	01010011	83	[S]	
60		41	01000001	65	[A]	
61		4D	01001101	77	[M]	
62		53	01010011	83	[S]	
63		55	01010101	85	[U]	
64		4E	01001110	78	[N]	
65		47	01000111	71	[G]	
66		0A	00001010	10	[^]	
67		20	00100000	32	[ ]	
68		20	00100000	32	[ ]	
69		20	00100000	32	[ ]	
6A	20	00100000	32	[ ]		
6B	20	00100000	32	[ ]		
6C	Detailed timing/monitor descriptor #4	00	00000000	0		Monitor Name Tag (ASCII)
6D		00	00000000	0		
6E		00	00000000	0		
6F		FE	11111110	254		
70		00	00000000	0		
71		4C	01001100	76	[L]	
72		54	01010100	84	[T]	
73		4E	01001110	78	[N]	
74		31	00110001	49	[1]	
75		35	00110101	53	[5]	
76		36	00110110	54	[6]	
77		41	01000001	65	[A]	
78		54	01010100	84	[T]	
79		31	00110001	49	[1]	
7A		39	00111001	57	[9]	
7B		30	00110000	48	[0]	
7C	0A	00001010	10	[*]		
7D	20	00100000	32	[*]		
7E	Extension Flag	00	00000000	0		
7F	Checksum	<b>B4</b>	10110100	<b>180</b>		

Samsung Secret