



ELECTRONICS

Approval



TO : Acer/Inventec

DATE : Mar. 12, 2008

SAMSUNG TFT-LCD

MODEL NO. : LTN160HT01-A02

NOTE : Extension code [-A]
→ LTN160HT01-A02
Surface type [Glare]

Any modification of spec is not allowed without SEC's permission

APPROVED BY :

K. H. Shin

PREPARED BY :

Kevin Kim

LCD DEVELOPMENT G1. MOBILE DIVISION
SAMSUNG ELECTRONICS CO., LTD.

Samsung Secret

Doc.No.	LTN160HT01-A02	Rev.No	04-A00-G-080312	Page	1 / 31
---------	----------------	--------	-----------------	------	--------

CONTENTS

Revision History	----- (3)
General Description	----- (4)
1. Absolute Maximum Ratings	----- (5)
1.1 Absolute Ratings of environment	
1.2 Electrical Absolute Ratings	
2. Optical Characteristics	----- (7)
3. Electrical Characteristics	----- (10)
3.1 TFT LCD Module	
3.2 Backlight Unit	
3.3 Inverter	
4. Block Diagram	----- (13)
4.1 TFT LCD Module	
4.2 Backlight Unit	
4.3 Inverter Unit	
5. Input Terminal Pin Assignment	----- (14)
5.1 Input Signal & Power	
5.2 LVDS Interface	
5.3 Backlight Unit	
5.4 Timing Diagrams of LVDS For Transmitting	
5.5 Input Signals, Basic Display Colors and Gray Scale of Each Color.	
5.6 Pixel format	
6. Interface Timing	----- (22)
6.1 Timing Parameters	
6.2 Timing Diagrams of interface Signal	
6.3 Power ON/OFF Sequence	
7. Outline Dimension	----- (24)
8. Packing	----- (25)
9. Marking & Others	----- (25)
10. General Precaution	----- (27)

Samsung Secret

REVISION HISTORY

Approval

Date	Revision No.	Page	Summary
Mar. 12. 2007	A00	All	LTN160HT01-A02 model Preliminary spec was issued first.

Samsung Secret

GENERAL DESCRIPTION**DESCRIPTION**

LTN160HT01-A02 is a color active matrix TFT (Thin Film Transistor) liquid crystal display (LCD) that uses amorphous silicon TFT as switching devices. This model is composed of a TFT LCD panel, a driver circuit and a backlight unit. The resolution of a 16.0" contains 1920 x 1080 pixels and can display up to 262,144 colors. 6 O'clock direction is the optimum viewing angle.

FEATURES

- High contrast ratio, high aperture structure
- 1920 x 1080 pixels resolution (16:9)
- High color Gamut (Typical 60%)
- Low power consumption
- Fast Response Time
- Single CCFL
- DE(Data enable) only mode
- 3.3V LVDS Interface
- Onboard EEDID chip
- RoHS Compliance

APPLICATIONS

- Notebook PC
- If the usage of this product is not for PC application, but for others, please contact SEC

GENERAL INFORMATION

Item	Specification	Unit	Note
Display area	353.28 (H) x 198.72 (V) (16.0" diagonal)	mm	
Driver element	a-Si TFT active matrix		
Display colors	262,144		
Number of pixel	1920 x 1080	pixel	16 : 9
Pixel arrangement	RGB vertical stripe		
Pixel pitch	0.184 (H) x 0.184 (V) (TYP.)	mm	
Display Mode	Normally white		
Surface treatment	Haze 0, Hardness 3H		

Samsung Secret

Doc.No.	LTN160HT01-A02	Rev.No	04-A00-G-080312	Page	4 / 31
----------------	----------------	---------------	-----------------	-------------	--------

Approval

Mechanical Information

Item		Min.	Typ.	Max.	Unit	Note
Module size	Horizontal (H)	364.5	365	365.5	mm	
	Vertical (V)	213.5	214	214.5	mm	
	Depth (D)	-	6.2	6.5	mm	
Weight		-	580	600	g	

Note (1) Measurement condition of outline dimension
 . Equipment : Vernier Calipers
 . Push Force : 500g · f (minimum)

1. ABSOLUTE MAXIMUM RATINGS

1.1 ENVIRONMENTAL ABSOLUTE RATINGS

Item	Symbol	Min.	Max.	Unit	Note
Storage temperate	TSTG	-20	60	°C	(1),(5)
Operating temperate (Temperature of glass surface)	TOPR	0	50	°C	(1),(5)
Shock (non-operating)	Snop	-	240	G	(2),(4)
Vibration (non-operating)	Vnop	-	2.41	G	(3),(4)

Note (1) Temperature and relative humidity range are shown in the figure below.
 95 % RH Max. ($40\text{ }^{\circ}\text{C} \geq T_a$)
 Maximum wet - bulb temperature at $39\text{ }^{\circ}\text{C}$ or less. ($T_a > 40\text{ }^{\circ}\text{C}$) No condensation

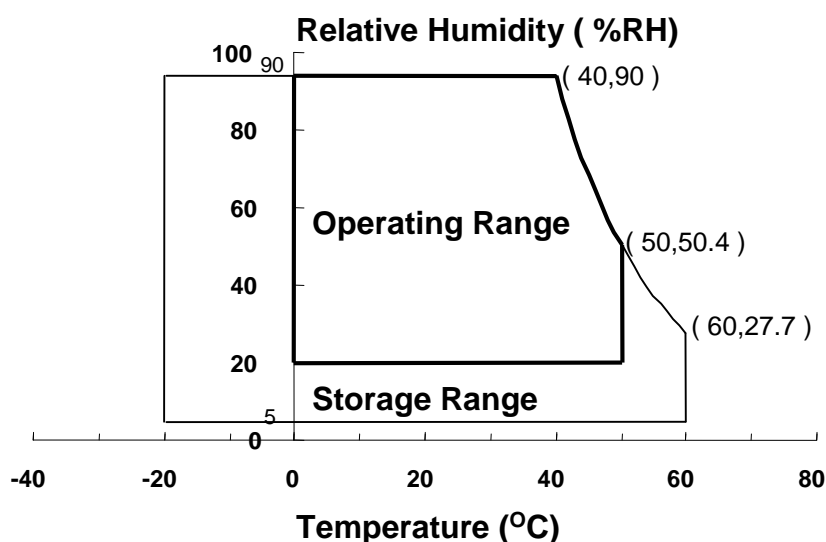

- (2) 2ms, half sine wave, one time for $\pm X, \pm Y, \pm Z$.
 (3) 5 - 500 Hz, random vibration, 30min for X, Y, Z.
 (4) At testing Vibration and Shock, the fixture in holding the Module to be tested have to be hard and rigid enough so that the Module would not be twisted or bent by the fixture.
 (5) If product is used for extended time excessively or exposed to high temperatures for extended time, there is a possibility of wide viewing angle film damage which could affect visual characteristics.

Samsung Secret

Doc.No.	LTN160HT01-A02	Rev.No	04-A00-G-080312	Page	5 / 31
---------	----------------	--------	-----------------	------	--------

1.2 ELECTRICAL ABSOLUTE RATINGS

(1) TFT LCD MODULE

 $V_{DD} = 3.3V, V_{SS} = GND = 0V$

Item	Symbol	Min.	Max.	Unit	Note
Power Supply Voltage	V_{DD}	$V_{DD} - 0.3$	$V_{DD} + 0.3$	V	(1)
Logic Input Voltage	V_{IN}	$V_{DD} - 0.3$	$V_{DD} + 0.3$	V	(1)

Note (1) Within T_a (25 ± 2 °C)

(2) BACK-LIGHT UNIT

 $T_a = 25 \pm 2$ °C

Item	Symbol	Min.	Max.	Unit	Note
Lamp Current	I_L	3.0	7.0	mArms	(1)
Lamp frequency	F_L	50	80	kHz	(1)

Note 1) Permanent damage to the device may occur if maximum values are exceeded
 Functional operation should be restricted to the conditions described under normal operating conditions.

Samsung Secret

2. OPTICAL CHARACTERISTICS

The following items are measured under stable conditions. The optical characteristics should be measured in a dark room or equivalent state with the methods shown in Note (5).
Measuring equipment : TOPCON BM-5A and PR-650

* Ta = 25 ± 2 °C, V_{DD}=3.3V, f_v= 60Hz, f_{DCLK} = (TBD)MHz, I_L = 6.5 mA

Item	Symbol	Condition	Min.	Typ.	Max	Unit	Note		
Contrast Ratio (5 Points)	CR	Normal Viewing Angle φ = 0 θ = 0	300	600	-	-	(1), (2), (5)		
Response Time at Ta (Rising + Falling)	T _{RT}		-	8	16	msec	(1), (3)		
Average Luminance of White (5 Points)	Y _{L,AVE}		210	250	-	cd/m ²	I _L =6.5mA (1), (4)		
Color Chromaticity (CIE)	Red		R _X	0.580	0.610	0.640	-	(1), (5) PR-650	
			R _Y	0.295	0.325	0.355			
	Green		G _X	0.270	0.300	0.330			
			G _Y	0.540	0.570	0.600			
	Blue		B _X	0.115	0.145	0.175			
			B _Y	0.055	0.085	0.115			
	White		W _X	0.283	0.313	0.343			
		W _Y	0.299	0.329	0.359				
Viewing Angle	Hor.	θ _L	65	75	-	Degrees	(1), (5) BM-5A		
		θ _H	65	75	-				
	Ver.	φ _H	50	60	-				
		φ _L	45	55	-				
	Hor.	θ _L	CR ≥ 100	30	40		Degrees	(1), (5) BM-5A	
				θ _H	30	40			
		Ver.		φ _H	10	20			
				φ _L	10	20			
13 Points White Variation	δ _L	-	-	2.2	-	(6)			

Samsung Secret

Note 1) Definition of Viewing Angle : Viewing angle range($10 \leq C/R$)

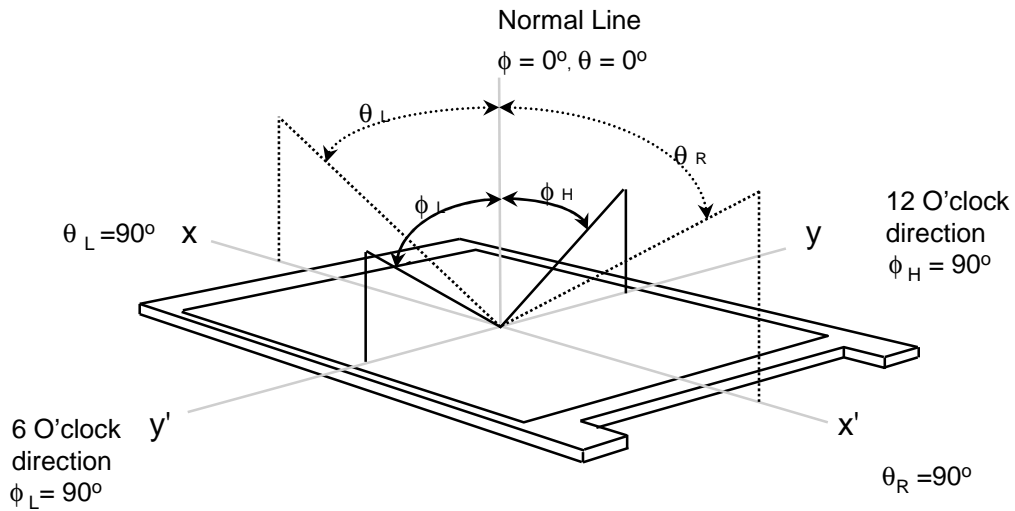

Note 2) Definition of Contrast Ratio (CR) : Ratio of gray max (Gmax) ,gray min (Gmin) at 5 points(4, 5, 7, 9, 10)

$$CR = \frac{CR(4) + CR(5) + CR(7) + CR(9) + CR(10)}{5}$$

Points : (4) , (5) , (7) , (9) , (10) at the figure of Note (6).

Note 3) Definition of Response time :

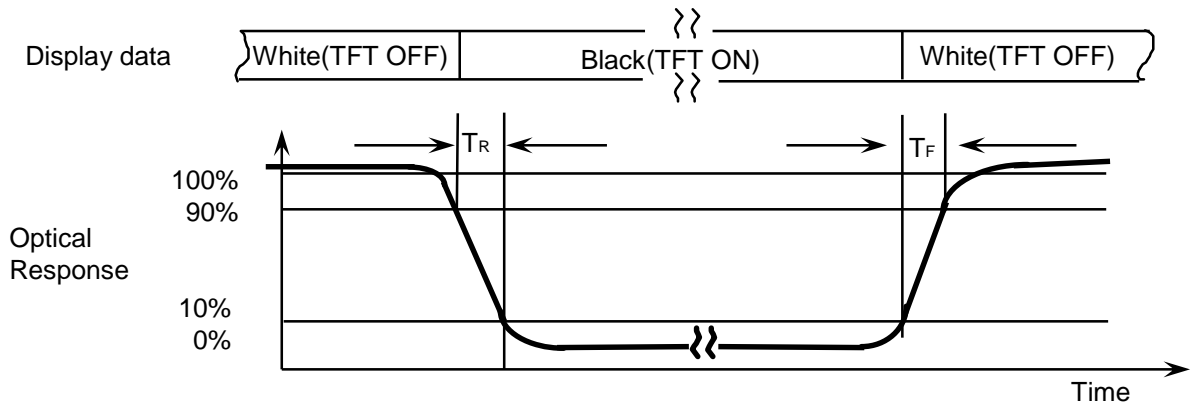

Note 4) Definition of Average Luminance of White : measure the luminance of white at 5 points.

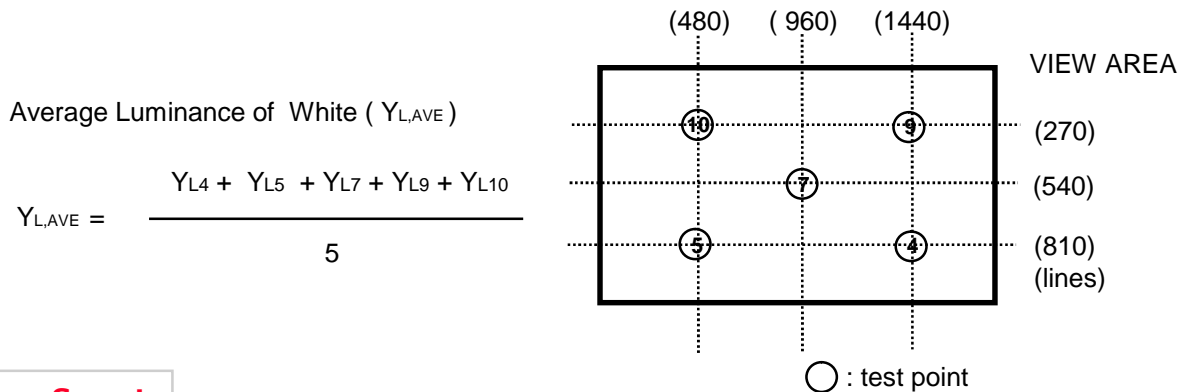

Samsung Secret

Note 5) After stabilizing and leaving the panel alone at a given temperature for 30 min , the measurement should be executed. Measurement should be executed in a stable, windless, and dark room. 30 min after lighting the backlight. This should be measured in the center of screen.
 Lamp current : 6.5mA (Inverter : SIC-130T)
 Environment condition : $T_a = 25 \pm 2 \text{ }^\circ\text{C}$

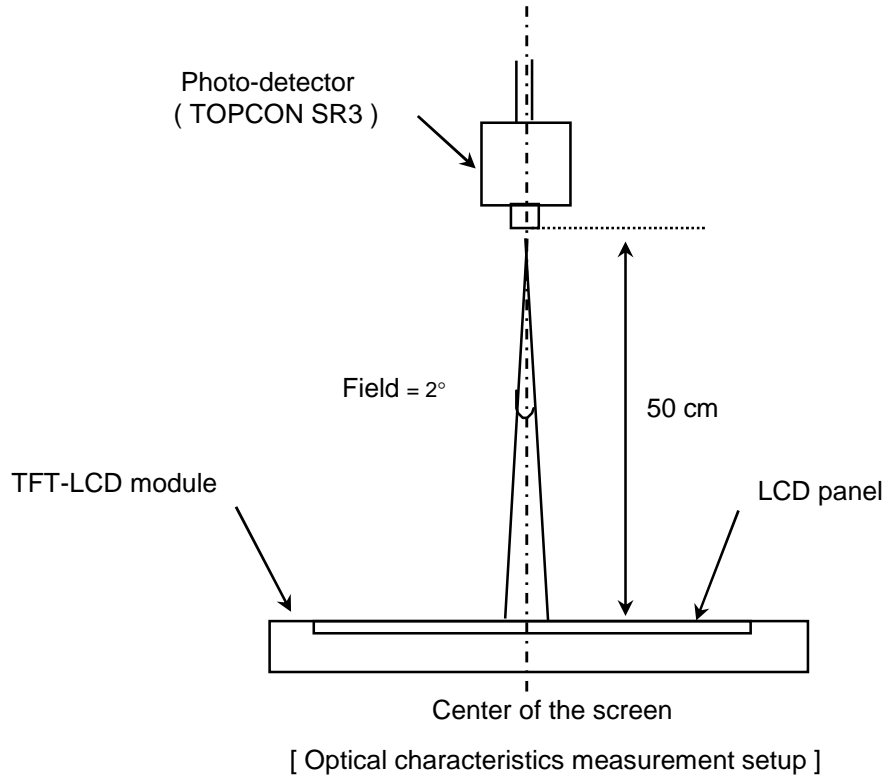

Note 6) Definition of 13 points white variation (δL), CR variation(C_{VER}) [① ~ ⑬]

$$\delta L = \frac{\text{Maximum luminance of 13 points}}{\text{Minimum luminance of 13 points}}$$

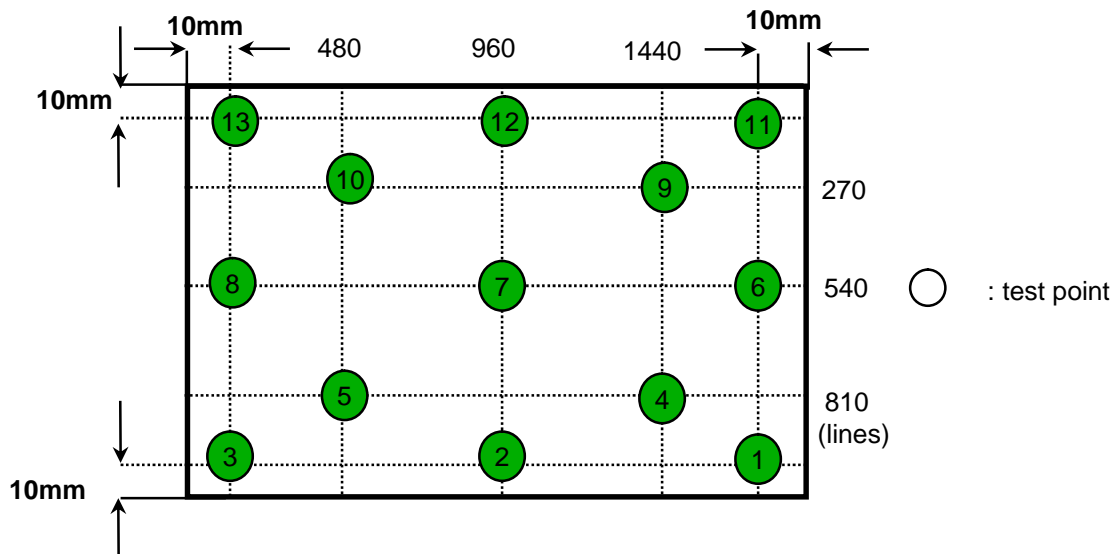

Samsung Secret

3. ELECTRICAL CHARACTERISTICS

3.1 TFT LCD MODULE

Ta= 25 ± 2°C

Item	Symbol	Min.	Typ.	Max.	Unit	Note	
Voltage of Power Supply	V _{DD}	3.0	3.3	3.6	V		
Differential Input Voltage for LVDS Receiver Threshold	High	V _{IH}	-	-	+100	mV	V _{CM} = +1.2V
	Low	V _{IL}	-100	-	-	mV	
Vsync Frequency	f _V	-	60	-	Hz		
Hsync Frequency	f _H	-	63.40	-	KHz		
Main Frequency	f _{DCLK}	-	69.33	-	MHz	2CH	
Rush Current	I _{RUSH}	-	-	2.5	A	(4)	
Current of Power Supply	White	I _{DD}	-	600	-	mA	(2),(3)*a
	Mosaic		-	750	-	mA	(2),(3)*b
	V. stripe		-	800	900	mA	(2),(3)*c

Note (1) Display data pins and timing signal pins should be connected.(GND = 0V)

(2) f_V = 60Hz, f_{DCLK} = 69.33 MHz, V_{DD} = 3.3V , DC Current.

(3) Power dissipation pattern

*a) White Pattern

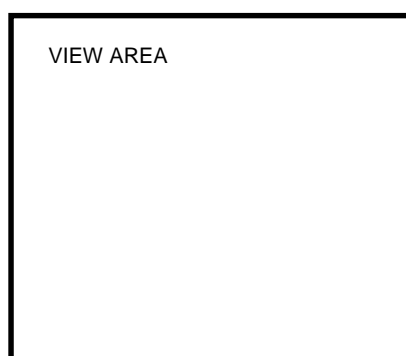

*b) Mosaic Pattern

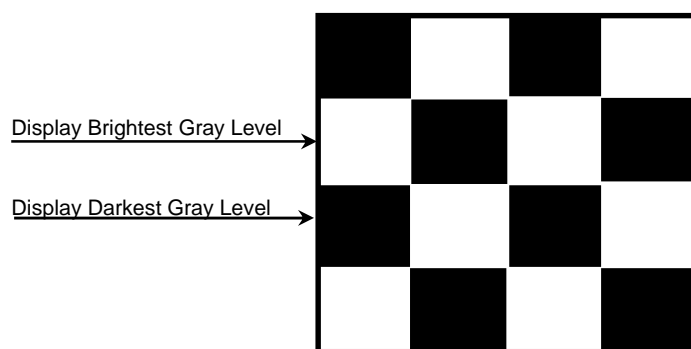

Samsung Secret

*c) 1dot Vertical stripe pattern

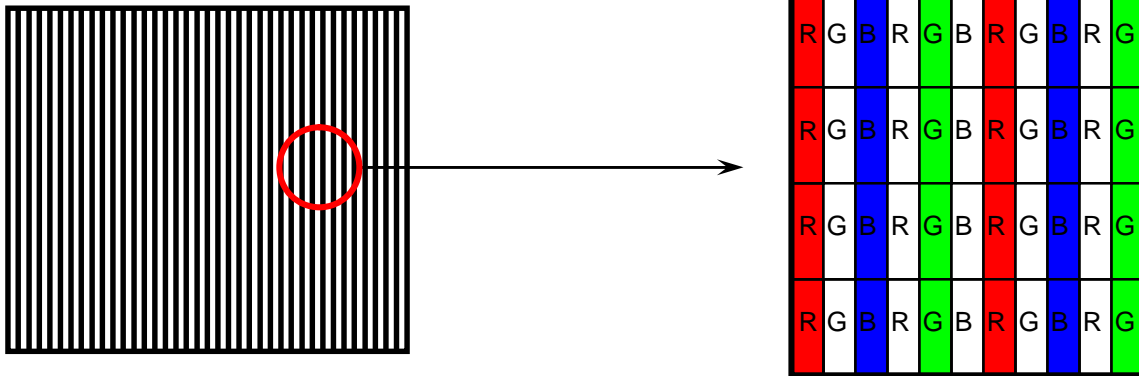

4) Rush current measurement condition

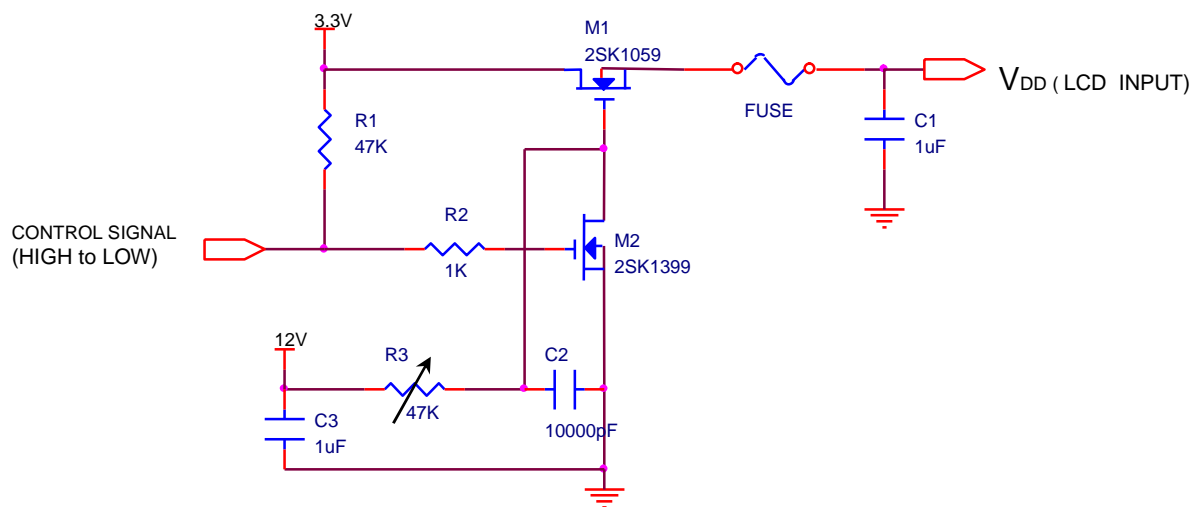

V_{DD} rising time is 470us

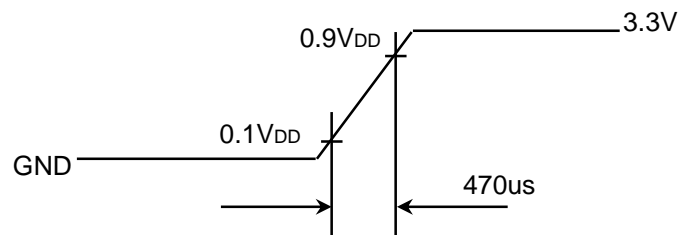

Samsung Secret

3.2 BACK-LIGHT UNIT

The backlight system is an edge-lighting type with a single CCFL (Cold Cathode Fluorescent Lamp).
The characteristics of a single lamp are shown in the following tables.

- INVERTER : (SEM SIC 130T)

Ta= 25 ± 2 °C

Item	Symbol	Min.	Typ.	Max.	Unit	Note
Lamp Current	I _L	3.0	6.5	7.0	mArms	(1)
Lamp Voltage	V _L	-	685	-	Vrms	I _L =6.5mA
Frequency	f _L	45	60	70	KHz	(2)
Power Consumption	P _L		4.5		W	(3) I _L =6.5mA
Operating Life Time	Hr	12,000			Hour	(4)
Startup Voltage	V _s	-	-	1,230	Vrms	25°C, (5)
				1,480	Vrms	0°C, (5)
Lamp startup time		-	-	1.0	sec	(5)

Note) The waveform of the inverter output voltage must be area symmetric and the design of the inverter must have specifications for the modularized lamp.

The performance of the backlight, for example life time or brightness, is much influenced by the characteristics of the DC-AC inverter for the lamp. So all the parameters of an inverter should be carefully designed so as not to produce too much leakage current from high-voltage output of the inverter. When you design or order the inverter, please make sure that a poor lighting caused by the mismatch of the backlight and the inverter(miss lighting, flicker, etc.) never occur. When you confirm it, the module should be operated in the same condition as it is installed in your instrument.

Note (1) Lamp current is measured with a high frequency current meter as shown below.

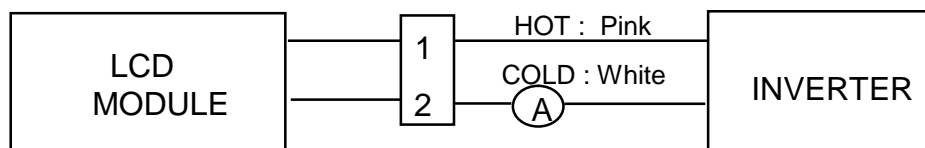

(2) Lamp frequency may produce interference with horizontal synchronous frequency and this may cause line flow on the display. Therefore lamp frequency should be detached from the horizontal synchronous frequency and its harmonics as far as possible in order to avoid interference.

(3) Refer to I_L × V_L to calculate.

(4) Life time (Hr) of a lamp can be defined as the time in which it continues to operate under the condition Ta= 25 ± 2 °C and I_L = 6.5 mArms until one of the following event occurs.

1. When the brightness becomes 50% or lower than the original.
2. When the Effective ignition length becomes 80% or lower than the original value.
(Effective ignition length is defined as an area that has less than 70% brightness compared to the brightness in the center point.)

(5) The inverter open voltage - this voltage should be measured after ballast capacitor- have to be larger than the lamp startup voltage, otherwise backlight may has blinking for a moment after turns on or not be turned on.

If an inverter has shutdown function it should keep its open voltage for longer than 1 second even if lamp connector open.

Samsung Secret

Doc.No.	LTN160HT01-A02	Rev.No	04-A00-G-080312	Page	12 / 31
---------	----------------	--------	-----------------	------	---------

4. BLOCK DIAGRAM

4.1 TFT LCD Module

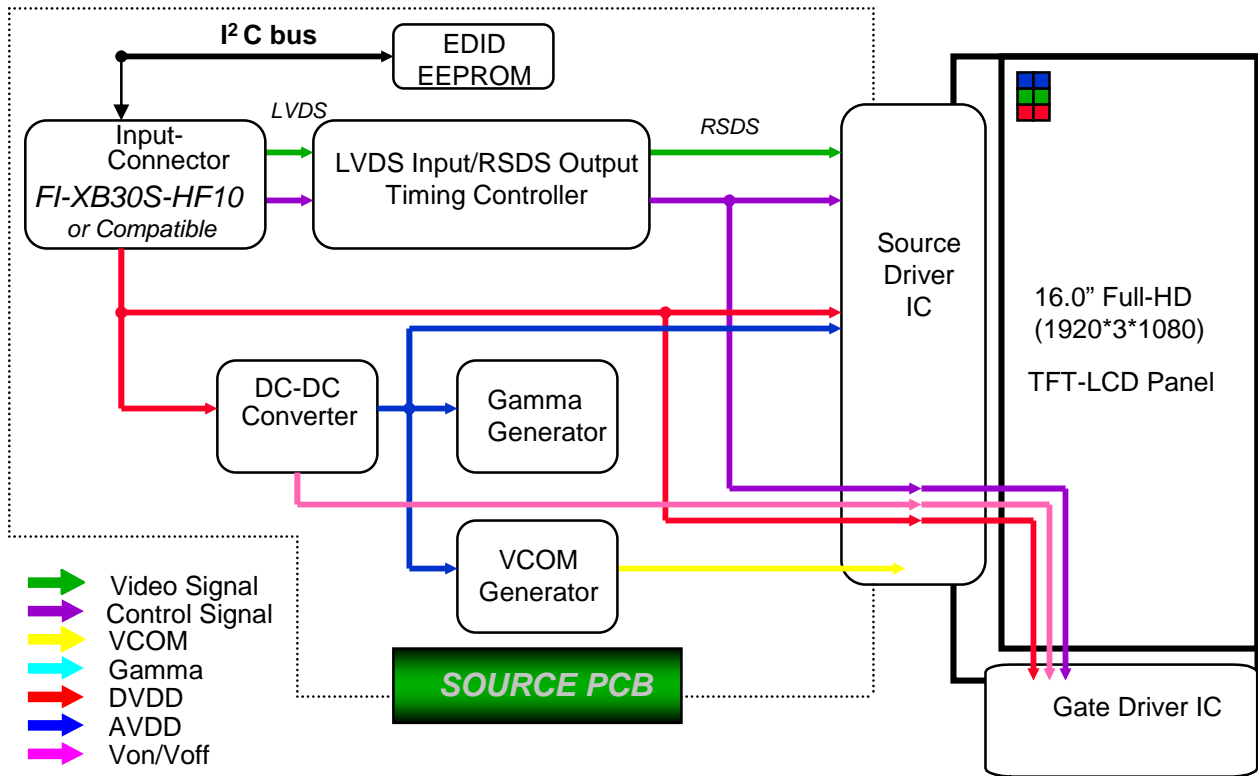

4.2 BACK-LIGHT UNIT

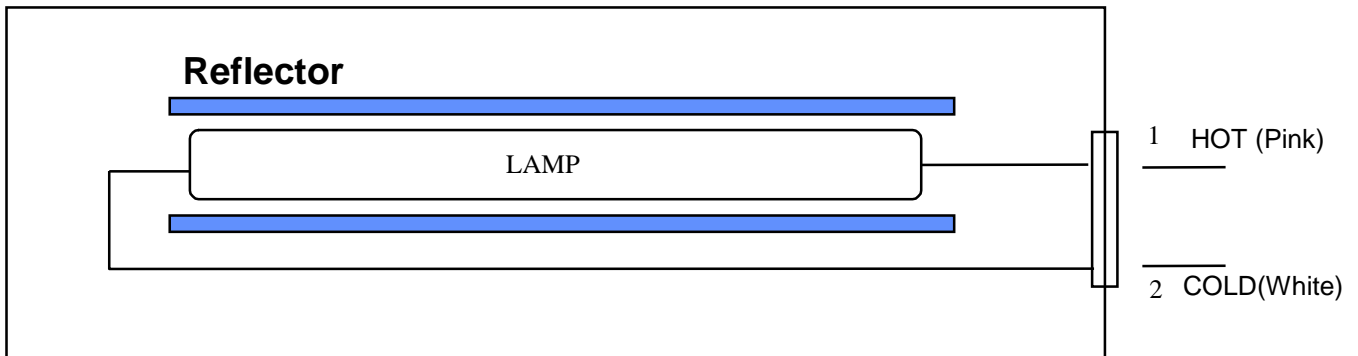

Note) The output of the inverter may change according to the material of the reflector.

Samsung Secret

Doc.No.	LTN160HT01-A02	Rev.No	04-A00-G-080312	Page	13 / 31
----------------	----------------	---------------	-----------------	-------------	---------

5. INPUT TERMINAL PIN ASSIGNMENT

5.1. Input Signal & Power (LVDS, Connector : JAE FI-XB30SL-HF10 or compatible)
Mating Connector : JAE FI-X30M or compatible)

No.	Symbol	Function	Polarity	Remarks
1	VSS	Ground		
2	VDD	POWER SUPPLY +3.3V		
3	VDD	POWER SUPPLY +3.3V		
4	VEEDID	DDC 3.3V Power		
5	NC	No Connection		
6	CLKEDID	DDC Clock		
7	DATAEDID	DDC data		
8	O_RxIN0-	LVDS Differential Data INPUT (Odd R0-R5,G0)	Negative	
9	O_RxIN0+	LVDS Differential Data INPUT (Odd R0-R5,G0)	Positive	
10	GND	Ground		
11	O_RxIN1-	LVDS Differential Data INPUT (Odd G1-G5,B0-B1)	Negative	
12	O_RxIN1+	LVDS Differential Data INPUT (Odd G1-G5,B0-B1)	Positive	
13	GND	Ground		
14	O_RxIN2-	LVDS Differential Data INPUT (Odd B2-B5,Sync,DE)	Negative	
15	O_RxIN2+	LVDS Differential Data INPUT (Odd B2-B5,Sync,DE)	Positive	
16	GND	Ground		
17	O_RxCLK-	LVDS Differential Data INPUT (Odd Clock)	Negative	
18	O_RxCLK+	LVDS Differential Data INPUT (Odd Clock)	Positive	
19	GND	Ground		
20	E_RxIN0-	LVDS Differential Data INPUT (Even R0-R5,G0)	Negative	
21	E_RxIN0+	LVDS Differential Data INPUT (Even R0-R5,G0)	Positive	
22	GND	Ground		
23	E_RxIN1-	LVDS Differential Data INPUT (Even G1-G5,B0-B1)	Negative	
24	E_RxIN1+	LVDS Differential Data INPUT (Even G1-G5,B0-B1)	Positive	
25	GND	Ground		
26	E_RxIN2-	LVDS Differential Data INPUT (Even B2-B5,Sync,DE)	Negative	
27	E_RxIN2+	LVDS Differential Data INPUT (Even B2-B5,Sync,DE)	Positive	
28	GND	Ground		
29	E_RxCLK-	LVDS Differential Data INPUT (Even Clock)	Negative	
30	E_RxCLK+	LVDS Differential Data INPUT (Even Clock)	Positive	

Samsung Secret

Doc.No.	LTN160HT01-A02	Rev.No	04-A00-G-080312	Page	14 / 31
----------------	----------------	---------------	-----------------	-------------	---------

Approval

5.2 LVDS Interface : Transmitter DS90CF365 or Compatible

LVDS for Odd pixel

Pin No.	Name	RGB Signal	Pin No.	Name	RGB Signal
44	TxIN0	RO0	12	TxIN11	GO5
45	TxIN1	RO1	13	TxIN12	BO0
47	TxIN2	RO2	15	TxIN13	BO1
48	TxIN3	RO3	16	TxIN14	BO2
1	TxIN4	RO4	18	TxIN15	BO3
3	TxIN5	RO5	19	TxIN16	BO4
4	TxIN6	GO0	20	TxIN17	BO5
6	TxIN7	GO1	22	TxIN18	Hsync
7	TxIN8	GO2	23	TxIN19	Vsync
9	TxIN9	GO3	25	TxIN20	DE
10	TxIN10	GO4	26	TxCLK IN	Clock

LVDS for Even pixel

Pin No.	Name	RGB Signal	Pin No.	Name	RGB Signal
44	TxIN0	RE0	12	TxIN11	GE5
45	TxIN1	RE1	13	TxIN12	BE0
47	TxIN2	RE2	15	TxIN13	BE1
48	TxIN3	RE3	16	TxIN14	BE2
1	TxIN4	RE4	18	TxIN15	BE3
3	TxIN5	RE5	19	TxIN16	BE4
4	TxIN6	GE0	20	TxIN17	BE5
6	TxIN7	GE1	22	TxIN18	N/C
7	TxIN8	GE2	23	TxIN19	N/C
9	TxIN9	GE3	25	TxIN20	N/C
10	TxIN10	GE4	26	TxCLK IN	Clock

Samsung Secret

Doc.No.	LTN160HT01-A02	Rev.No	04-A00-G-080312	Page	15 / 31
----------------	----------------	---------------	-----------------	-------------	---------

LVDS Interface

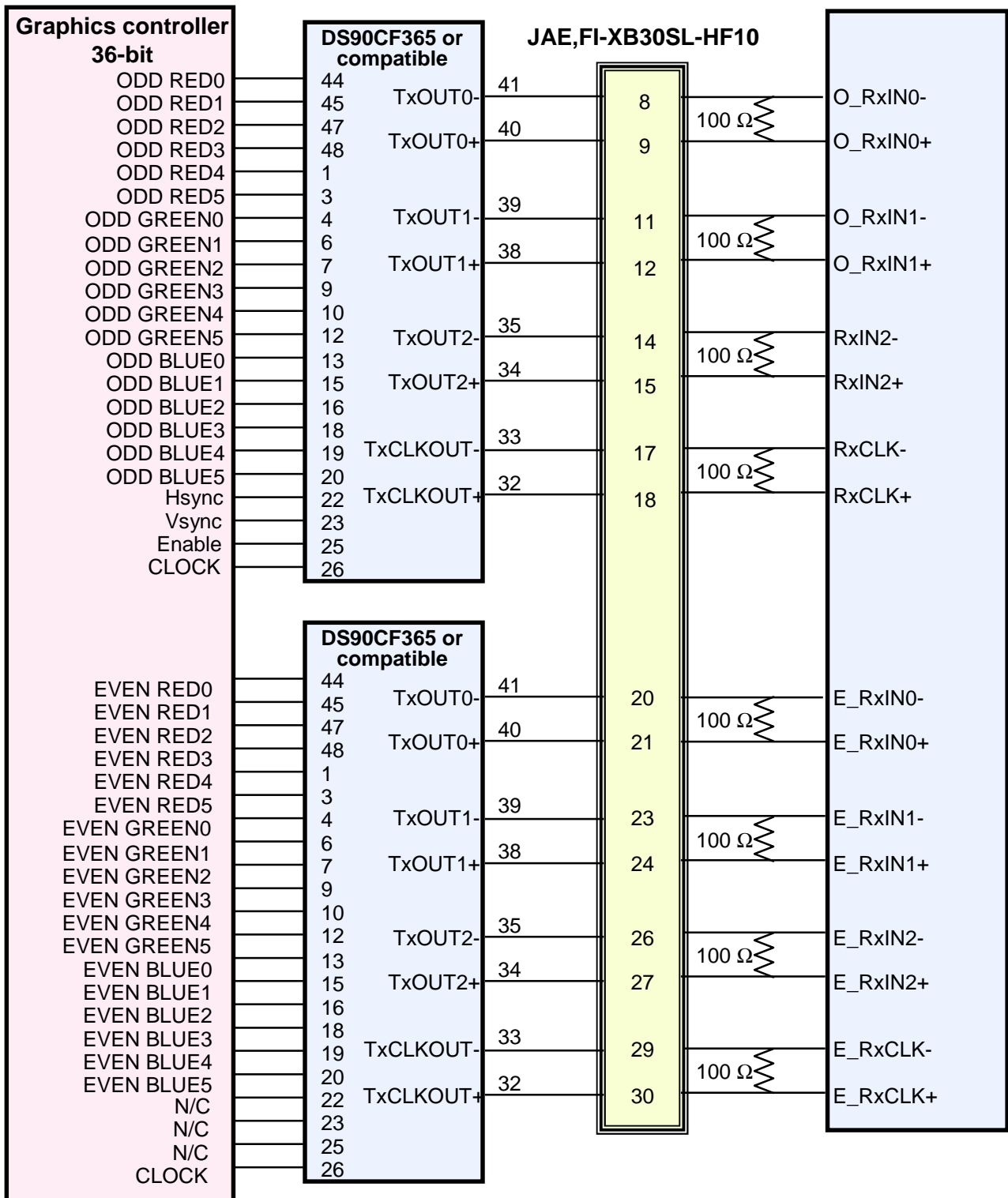

Note : The LCD Module uses a 100ohm resistor between positive and negative lines of each receiver input.

Samsung Secret

5.3 BACK LIGHT UNIT

Approval

Connector : JST BHSR - 02VS -1
Mating Connector : SM02B-BHSS-1

Pin NO.	Symbol	Color	Function
1	HOT	Pink	High Voltage
2	COLD	White	Low Voltage

5.4 Timing Diagrams of LVDS For Transmission

LVDS Receiver : Integrated T-CON

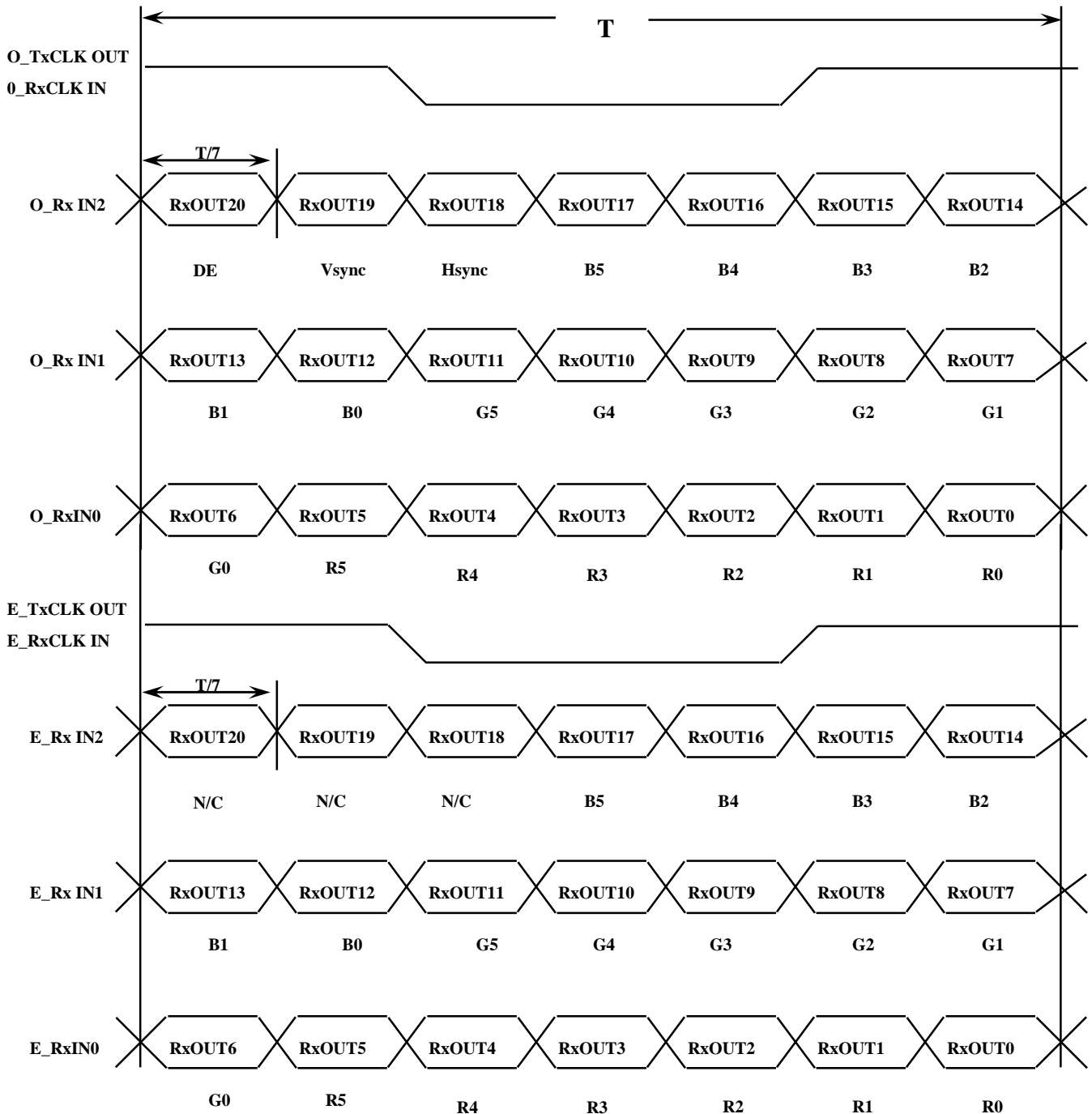

Samsung Secret

Approval

5.5 Input Signals, Basic Display Colors and Gray Scale of Each Color

Color	Display	Data Signal																Gray Scale Level	
		Red					Green					Blue							
		R0	R1	R2	R3	R4	R5	G0	G1	G2	G3	G4	G5	B0	B1	B2	B3		45
Basic Colors	Black	0	0	0	0	0	0	0	0	0	0	0	0	0	0	0	0	0	-
	Blue	0	0	0	0	0	0	0	0	0	0	0	0	1	1	1	1	1	-
	Green	0	0	0	0	0	0	1	1	1	1	1	1	0	0	0	0	0	-
	Cyan	0	0	0	0	0	0	1	1	1	1	1	1	1	1	1	1	1	-
	Red	1	1	1	1	1	1	0	0	0	0	0	0	0	0	0	0	0	-
	Magenta	1	1	1	1	1	1	0	0	0	0	0	0	1	1	1	1	1	-
	Yellow	1	1	1	1	1	1	1	1	1	1	1	1	0	0	0	0	0	-
	White	1	1	1	1	1	1	1	1	1	1	1	1	1	1	1	1	1	-
Gray Scale Of Red	Black	0	0	0	0	0	0	0	0	0	0	0	0	0	0	0	0	0	R0
	Dark	1	0	0	0	0	0	0	0	0	0	0	0	0	0	0	0	0	R1
	↑	0	1	0	0	0	0	0	0	0	0	0	0	0	0	0	0	0	R3~R60
	:	:	:	:	:	:	:	:	:	:	:	:	:	:	:	:	:	:	
	:	:	:	:	:	:	:	:	:	:	:	:	:	:	:	:	:	:	
	↓	1	0	1	1	1	1	0	0	0	0	0	0	0	0	0	0	0	R61
	Light	0	1	1	1	1	1	0	0	0	0	0	0	0	0	0	0	0	R62
	Red	1	1	1	1	1	1	0	0	0	0	0	0	0	0	0	0	0	R63
Gray Scale Of Green	Black	0	0	0	0	0	0	0	0	0	0	0	0	0	0	0	0	0	G0
	Dark	0	0	0	0	0	0	1	0	0	0	0	0	0	0	0	0	0	G1
	↑	0	0	0	0	0	0	0	1	0	0	0	0	0	0	0	0	0	G3~G60
	:	:	:	:	:	:	:	:	:	:	:	:	:	:	:	:	:	:	
	:	:	:	:	:	:	:	:	:	:	:	:	:	:	:	:	:	:	
	↓	0	0	0	0	0	0	1	0	1	1	1	1	0	0	0	0	0	G61
	Light	0	0	0	0	0	0	0	1	1	1	1	1	0	0	0	0	0	G62
	Green	0	0	0	0	0	0	1	1	1	1	1	1	0	0	0	0	0	G63
Gray Scale Of Blue	Black	0	0	0	0	0	0	0	0	0	0	0	0	0	0	0	0	0	B0
	Dark	0	0	0	0	0	0	0	0	0	0	0	0	1	0	0	0	0	B1
	↑	0	0	0	0	0	0	0	0	0	0	0	0	0	1	0	0	0	B2
	:	:	:	:	:	:	:	:	:	:	:	:	:	:	:	:	:	:	B3~B60
	:	:	:	:	:	:	:	:	:	:	:	:	:	:	:	:	:	:	
	↓	0	0	0	0	0	0	0	0	0	0	0	0	1	0	1	1	1	
	Light	0	0	0	0	0	0	0	0	0	0	0	0	0	1	1	1	1	B62
	Blue	0	0	0	0	0	0	0	0	0	0	0	0	1	1	1	1	1	B63

Note 1) Definition of gray :

Rn: Red gray, Gn: Green gray, Bn: Blue gray (n=gray level)

Note 2) Input signal: 0 =Low level voltage, 1=High level voltage

Samsung Secret

Approval

5.6 Pixel Format in the display

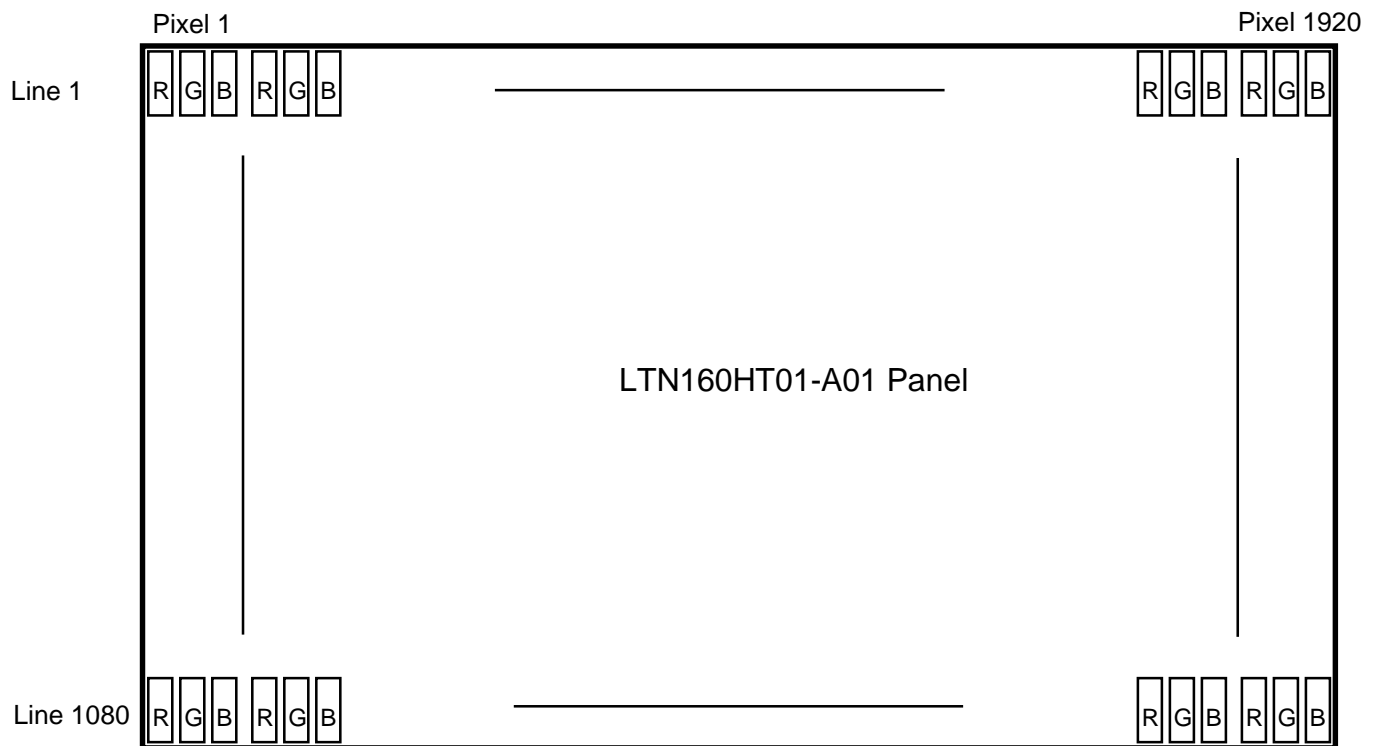

Samsung Secret

6. INTERFACE TIMING

6.1 Timing Parameters

Signal	Item	Symbol	Min.	Typ.	Max.	Unit	Note
Frame Frequency	Cycle	TV		1111		Lines	
Vertical Active Display Term	Display Period	TVD		1080		Lines	
One Line Scanning Time	Cycle	TH		1040		Clocks	
Horizontal Active Display Term	Display Period	THD	-	960	-	Clocks	

6.2 Timing diagrams of interface signal

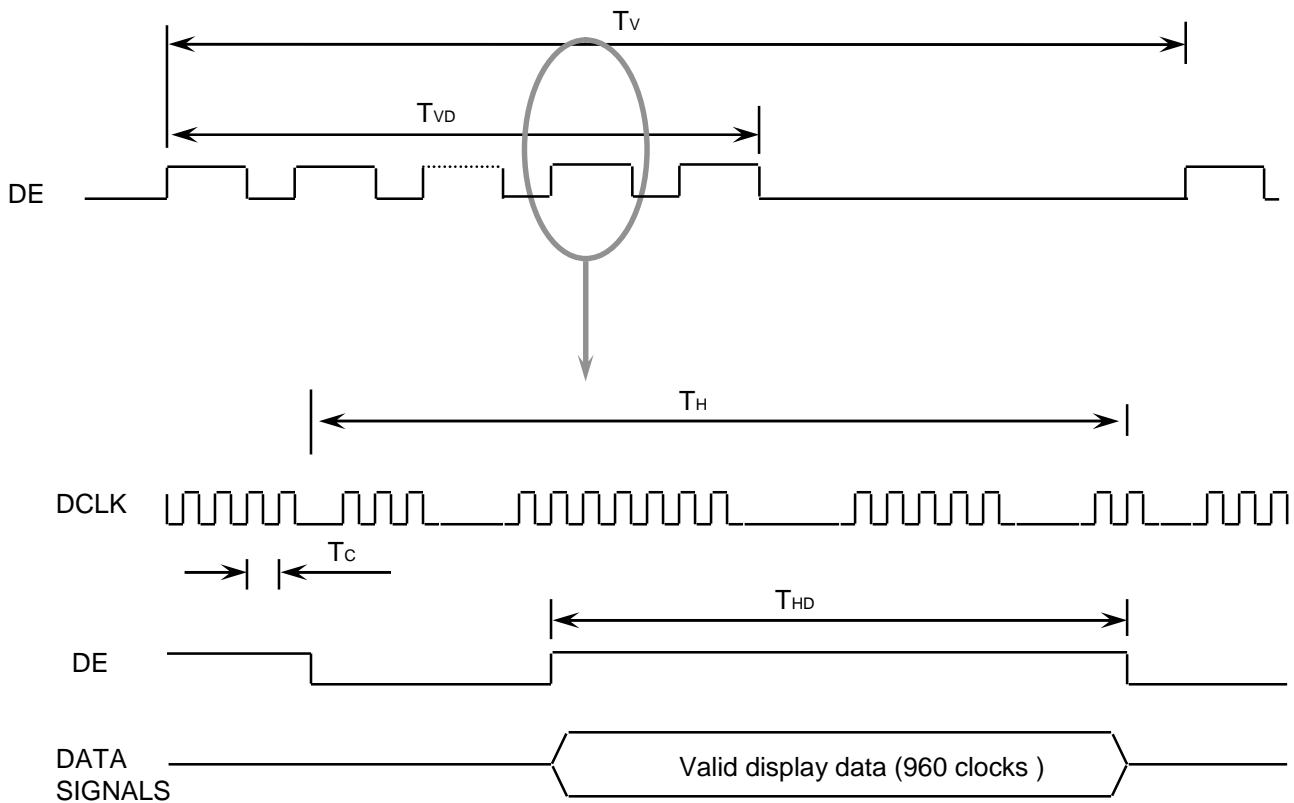

Samsung Secret

6.3 Power ON/OFF Sequence

: To prevent a latch-up or DC operation of the LCD module, the power on/off sequence should be as the diagram below.

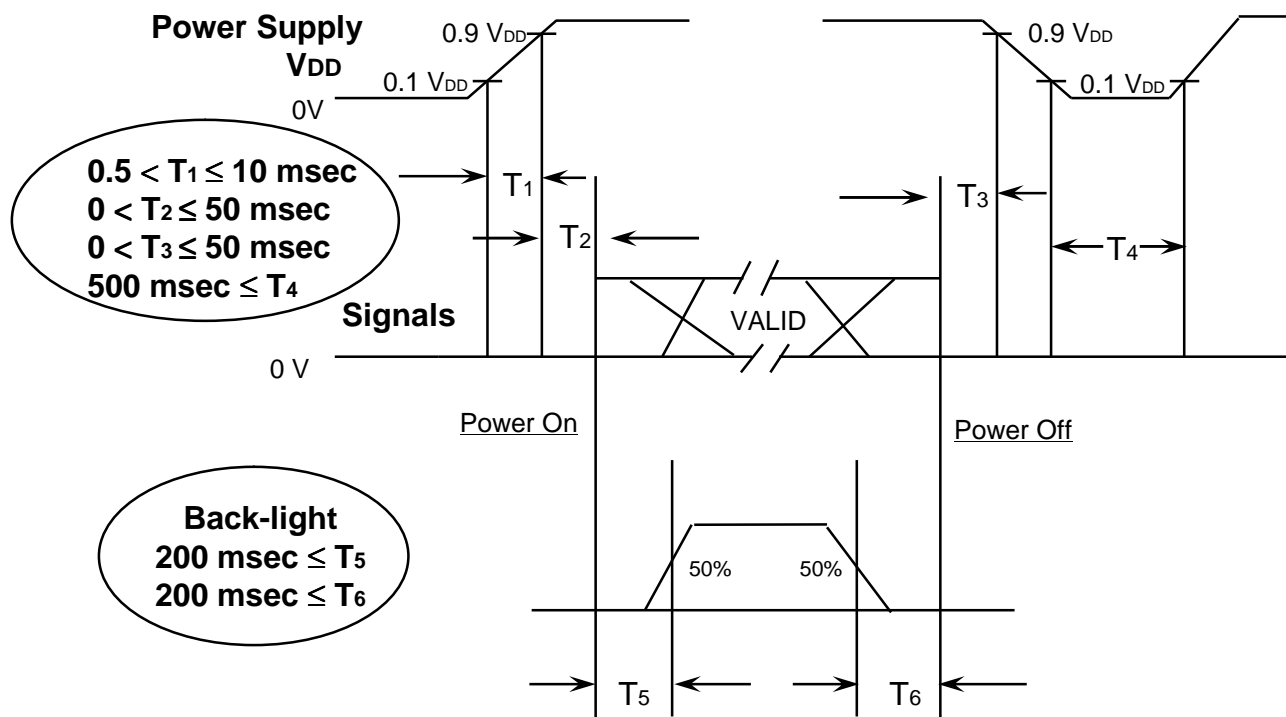
Power ON/OFF Sequence

- T1 : Vdd rising time from 10% to 90%
 T2 : The time from Vdd to valid data at power ON.
 T3 : The time from valid data off to Vdd off at power Off.
 T4 : Vdd off time for Windows restart
 T5 : The time from valid data to B/L enable at power ON.
 T6 : The time from valid data off to B/L disable at power Off.

NOTE.

- (1) The supply voltage of the external system for the module input should be the same as the definition of V_{DD}.
- (2) Apply the lamp voltage within the LCD operation range. When the back-light turns on before the LCD operation or the LCD turns off before the back-light turns off, the display may momentarily become white.
- (3) In case of V_{DD} = off level, please keep the level of input signals on the low or keep a high impedance.
- (4) T4 should be measured after the module has been fully discharged between power off and on period.
- (5) Interface signal shall not be kept at high impedance when the power is on.

Samsung Secret

Doc.No.	LTN160HT01-A02	Rev.No	04-A00-G-080312	Page	21 / 31
---------	----------------	--------	-----------------	------	---------

7. Mechanical Outline Dimension

Approval

[Refer to the next page]

Samsung Secret

Doc.No.	LTN160HT01-A02	Rev.No	04-A00-G-080312	Page	22 / 31
----------------	----------------	---------------	-----------------	-------------	---------

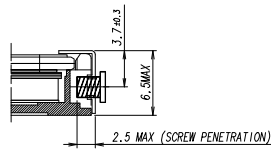

SECTION A-A'

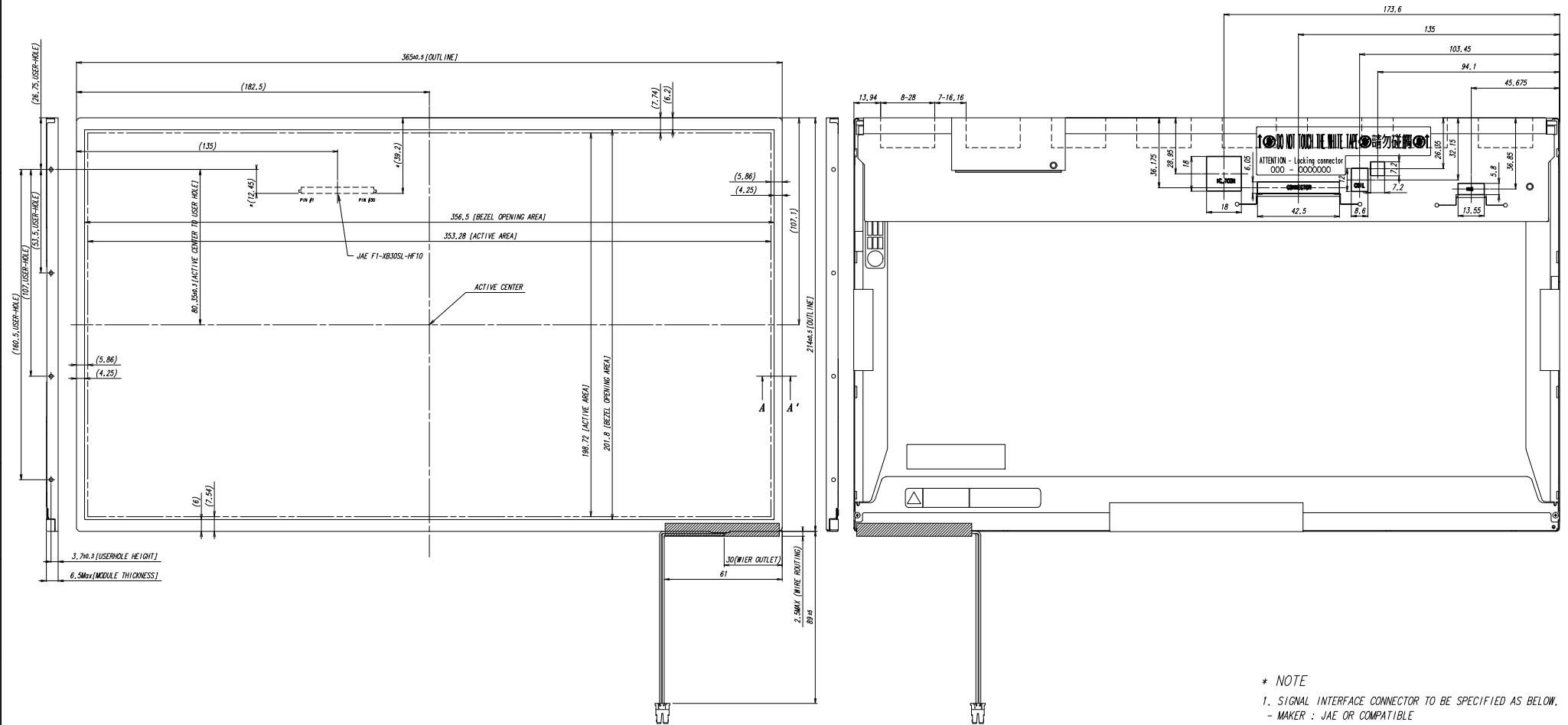
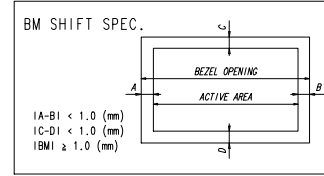

- * NOTE
- SIGNAL INTERFACE CONNECTOR TO BE SPECIFIED AS BELOW.
- MAKER : JAE OR COMPATIBLE
- INPUT CONNECTOR : JAE FI-XB30SL-HF10
 - CCF CONNECTOR FOR BACKLIGHT TO BE SPECIFIED AS BELOW.
- MAKER : JST
- PART NO : BHSR-02VS-1
 - ALLOWED DEPTH OF USERHOLE SCREW INSERTION IS MAX 2.5mm
 - TORQUE SPEC : MAX 2.5 Kgf-cm

GENERAL TOLERANCE				REV	DATE	DESCRIPTION OF REVISION			REASON	CHK'D BY
STEP	LEVEL 1	LEVEL 2	LEVEL 3	UNIT	DRAWN BY	DES'D BY	CHK'D BY	APP'D BY	MODEL NAME	LTN160HT01-A01
0 < X ≤ 4	±0.05	±0.1	±0.2	mm	M.S.KIM				PART/SHEET NAME	OUTLINE DIMENSION
4 < X ≤ 16	±0.08	±0.15	±0.3	SCALE					SPEC. NO.	
16 < X ≤ 64	±0.12	±0.25	±0.5	TOLERANCE					CODE NO.	
64 < X ≤ 256	±0.25	±0.4	±0.8	LEVEL 3					VER.	000

SAMSUNG ELECTRONICS

Approval

8. PACKING

1. CARTON(Internal Package)

(1) Packing Form

Corrugated Cardboard box and Corrupad form as shock absorber

(2) Packing Method

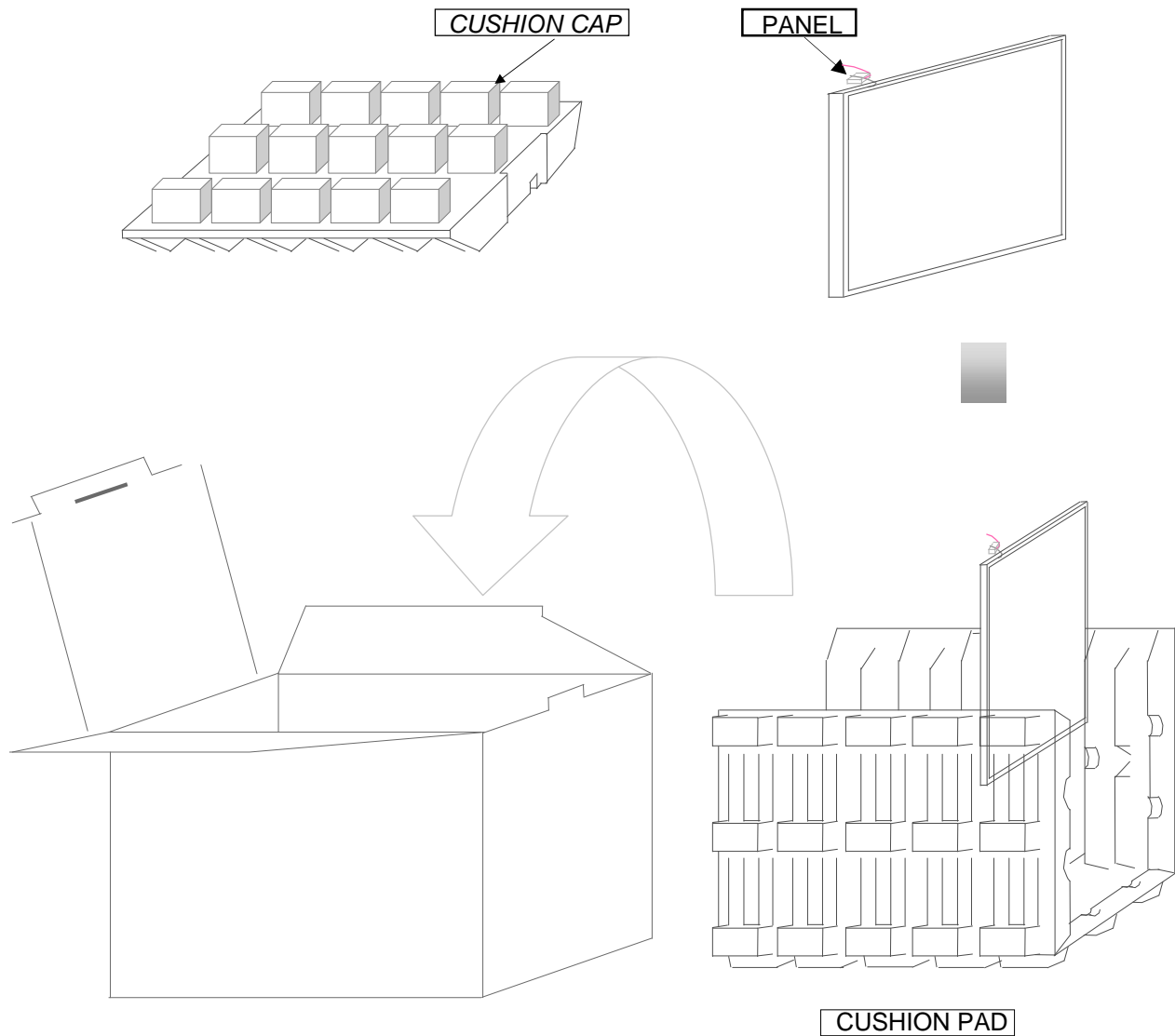

Note 1) Total Weight : Approximately (TBD) kg

2) Acceptance number of piling : 10 sets

3) Carton size : 376(W) x 326(D) x 404 (H)

PACKING CASE

Samsung Secret

Doc.No.	LTN160HT01-A02	Rev.No	04-A00-G-080312	Page	24 / 31
---------	----------------	--------	-----------------	------	---------

Approval

(3)Packing Material

No	Part name	Quantity
1	Static electric protective sack	10 pcs
2	Packing case (Inner box) included shock absorber	1 set
3	Pictorial marking	2 pcs
4	Carton	1 set

9. MARKINGS & OTHERS

A nameplate bearing followed by is affixed to a shipped product at the specified location on each product.

(1)Parts number : LTN160HT01

(2)Revision code : 3 letters

(3)Lot number : X X X X XX XX XX A02

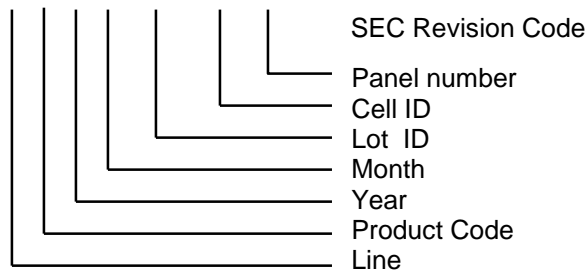

(4) Nameplate Indication

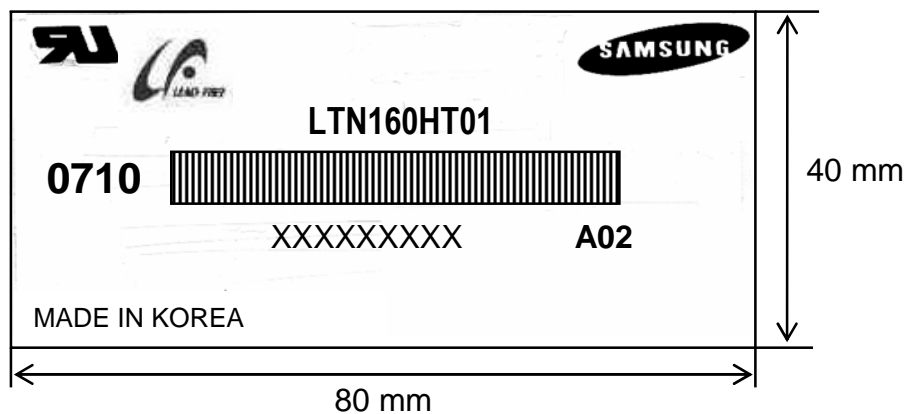

Parts name : LTN160HT01
 Lot number : XXXXXXXXXX
 Inspected work week : 0710(2007 year 10th week)
 Product Revision Code : A02

Samsung Secret

Approval

(5) High voltage caution label

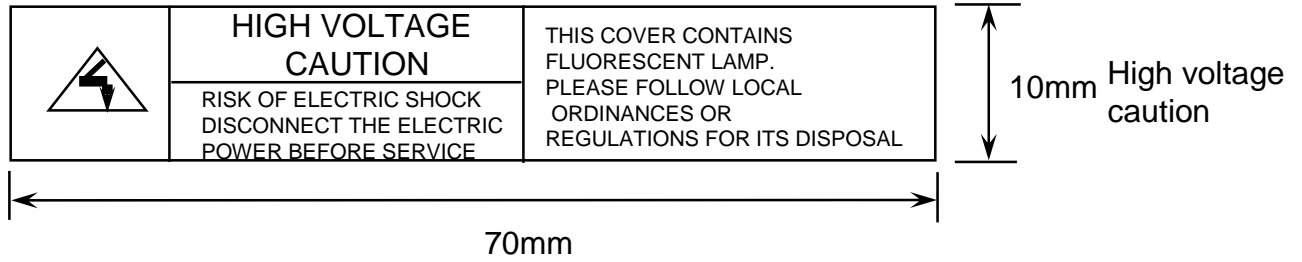

(6) Packing small box attach

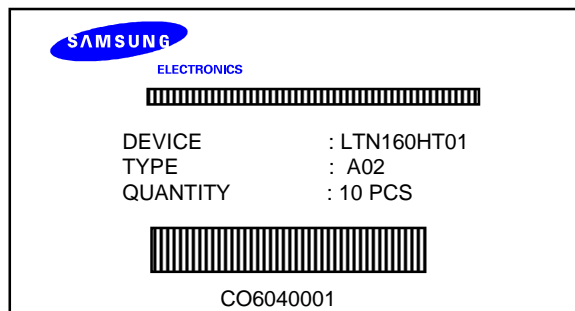

(7) Packing box Marking : Samsung TFT-LCD Brand Name



Samsung Secret

Doc.No.	LTN160HT01-A02	Rev.No	04-A00-G-080312	Page	26 / 31
----------------	----------------	---------------	-----------------	-------------	---------

10. GENERAL PRECAUTIONS

1. Handling

- (a) When the module is assembled, It should be attached to the system firmly using every mounting holes. Be careful not to twist and bend the modules.
- (b) Refrain from strong mechanical shock and / or any force to the module. In addition to damage, this may cause improper operation or damage to the module and CCFT backlight.
- (c) Note that polarizers are very fragile and could be easily damaged. Do not press or scratch the surface harder than a HB pencil lead.
- (d) Wipe off water droplets or oil immediately. If you leave the droplets for a long time, Staining and discoloration may occur.
- (e) If the surface of the polarizer is dirty, clean it using some absorbent cotton or soft cloth.
- (f) The desirable cleaners are water, IPA(Isoprophyl Alcohol) or Hexane. Do not use Ketone type materials(ex. Acetone), Ethyl alcohol, Toluene, Ethyl acid or Methyl chloride. It might permanent damage to the polarizer due to chemical reaction.
- (g) If the liquid crystal material leaks from the panel, it should be kept away from the eyes or mouth. In case of contact with hands, legs or clothes, it must be washed away thoroughly with soap.
- (h) Protect the module from static, it may cause damage to the C-MOS Gate Array IC.
- (i) Use fingerstalls with soft gloves in order to keep display clean during the incoming inspection and assembly process.
- (j) Do not disassemble the module.
- (k) Do not pull or fold the lamp wire.
- (l) Do not adjust the variable resistor which is located on the back side.
- (m) Protection film for polarizer on the module shall be slowly peeled off just before use so that the electrostatic charge can be minimized.
- (n) Pins of I/F connector shall not be touched directly with bare hands.

Samsung Secret

Doc.No.	LTN160HT01-A02	Rev.No	04-A00-G-080312	Page	27 / 31
----------------	----------------	---------------	-----------------	-------------	---------

2. STORAGE

- (a) Do not leave the module in high temperature, and high humidity for a long time.
It is highly recommended to store the module with temperature from 0 to 35 °C and relative humidity of less than 70%.
- (b) Do not store the TFT-LCD module in direct sunlight.
- (c) The module shall be stored in a dark place. It is prohibited to apply sunlight or fluorescent light during the store.

3. OPERATION

- (a) Do not connect, disconnect the module in the “ Power On” condition.
- (b) Power supply should always be turned on/off by following item 6.3
“ Power on/off sequence “.
- (c) Module has high frequency circuits. Sufficient suppression to the electromagnetic interference shall be done by system manufacturers. Grounding and shielding methods may be important to minimize the interference.
- (d) The cable between the backlight connector and its inverter power supply shall be a minimized length and be connected directly . The longer cable between the backlight and the inverter may cause lower luminance of lamp(CCFT) and may require higher startup voltage(Vs).
- (e) The standard limited warranty is only applicable when the module is used for general notebook applications. If used for purposes other than as specified, SEC is not to be held reliable for the defective operations. It is strongly recommended to contact SEC to find out fitness for a particular purpose.

4. OTHERS

- (a) Ultra-violet ray filter is necessary for outdoor operation.
- (b) Avoid condensation of water. It may result in improper operation or disconnection of electrode.
- (c) Do not exceed the absolute maximum rating value. (the supply voltage variation, input voltage variation, variation in part contents and environmental temperature, so on)
Otherwise the module may be damaged.
- (d) If the module displays the same pattern continuously for a long period of time, it can be the situation when the image “sticks” to the screen.
- (e) This module has its circuitry PCB’s on the rear side and should be handled carefully in order not to be stressed.

Samsung Secret

Doc.No.	LTN160HT01-A02	Rev.No	04-A00-G-080312	Page	28 / 31
----------------	----------------	---------------	-----------------	-------------	---------

11. EDID

Approval

Address (HEX)	FUNCTION	Value	BIN	DEC	ASCII or Data	Notes
		HEX				
00	Header	00	00000000	0		EDID Header
01		FF	11111111	255		
02		FF	11111111	255		
03		FF	11111111	255		
04		FF	11111111	255		
05		FF	11111111	255		
06		FF	11111111	255		
07		00	00000000	0		
08	ID Manufacturer Name	4C	01001100	76	S	3 character ID
09		A3	10100011	163	E C	"SEC"
0A	ID Product Code	4C	01001100	76	[L]	
0B		30	00110000	48	[0]	
0C	32-bit serial no.	00	00000000	0		
0D		00	00000000	0		
0E		00	00000000	0		
0F		00	00000000	0		
10	Week of manufacture	00	00000000	0		
11	Year of manufacture	12	00010010	18	2008	2008
12	EDID Structure Ver.	01	00000001	1	1	EDID Ver. 1.0
13	EDID revision #	03	00000011	3	3	EDID Rev. 3
14	Video input definition	80	10000000	128		
15	Max H image size	23	00100011	35	35	35 cm(approx)
16	Max V image size	14	00010100	20	20	20 cm(approx)
17	Display Gamma	78	01111000	120	2.2	Gamma 2.2
18	Feature support	0A	00001010	10		
19	Red/green low bits	87	10000111	135		10000111
1A	Blue/white low bits	F5	11110101	245		11111110
1B	Red x/ high bits	94	10010100	148	0.580	Red x0.580= 1001010010
1C	Red y	57	01010111	87	0.340	Red y0.340= 0101011100
1D	Green x	4F	01001111	79	0.310	Green x0.310= 0100111101
1E	Green y	8C	10001100	140	0.550	Green y0.550= 1000110011
1F	Blue x	27	00100111	39	0.155	Blue x0.155= 0010011111
20	Blue y	27	00100111	39	0.155	Blue y0.155= 0010011111
21	White x	50	01010000	80	0.313	White x0.313= 0101000001
22	White y	54	01010100	84	0.329	White y0.329= 0101010001
23	Established timing 1	00	00000000	0		
24	Established timing 2	00	00000000	0		
25	Established timing 3	00	00000000	0		

Samsung Secret

Doc.No.	LTN160HT01-A02	Rev.No	04-A00-G-080312	Page	29 / 31
---------	----------------	--------	-----------------	------	---------

Approval

26	Standard timing #1	01	00000001	1		not used	
27		01	00000001	1			
28	Standard timing #2	01	00000001	1		not used	
29		01	00000001	1			
2A	Standard timing #3	01	00000001	1		not used	
2B		01	00000001	1			
2C	Standard timing #4	01	00000001	1		not used	
2D		01	00000001	1			
2E	Standard timing #5	01	00000001	1		not used	
2F		01	00000001	1			
30	Standard timing #6	01	00000001	1		not used	
31		01	00000001	1			
32	Standard timing #7	01	00000001	1		not used	
33		01	00000001	1			
34	Standard timing #8	01	00000001	1		not used	
35		01	00000001	1			
36	Detailed timing/monitor descriptor #1	29	00101001	41	138.65	Main clock= 138.65 MHz	
37		36	00110110	54			
38		80	10000000	128	1920	Hor active=1920 pixels	
39		A0	10100000	160	160	Hor blanking=160 pixels	
3A		70	01110000	112		4bit : 4bit	
3B		38	00111000	56	1080	Vertical active=1080 lines	
3C		1F	00011111	31	31	Vertical blanking=31 lines	
3D		40	01000000	64		4bit : 4bit	
3E		30	00110000	48	48		
3F		20	00100000	32	32	H sync. Width=32 pixels	
40		25	00100101	37	2	V sync. Offset=2 lines	
					5	V sync. Width=5 lines	
41		00	00000000	0		2bit : 2bit :2bit :2bit	
42		61	01100001	97	353	H image size= 353 mm(approx)	
43		C6	11000110	198	198	V image size = 198 mm(approx)	
44		10	00010000	16			
45		00	00000000	0		No Horizontal Border	
46	00	00000000	0		No Vertical Border		
47	19	00011001	25				
48	Detailed timing/monitor descriptor #2	00	00000000	0		Manufacturer Specified (Timing)	
49		00	00000000	0			
4A		00	00000000	0			
4B		0F	00001111	15			
4C		00	00000000	0		Value=HSPWmin / 2	
4D		00	00000000	0		Value=HSPWmax / 2	
4E		00	00000000	0		Value=Thbpmin / 2	
4F		00	00000000	0		Value=Thbpmax / 2	
50		00	00000000	0		Value=VSPWmin / 2	
51		00	00000000	0		Value=VSPWmax / 2	
52		00	00000000	0		Value=Tvpmin / 2	
53		00	00000000	0		Value=Tvpmax / 2	
54		00	00000000	0		Thpmin=value*2 + HA pixelclks	
55		20	00100000	32		Thpmax=value*2 + HA pixelclks	
56		91	10010001	145		Tvpmin=value*2 + VA lines	
57		02	00000010	2		Tvpmax=value*2 + VA lines	
58		64	01100100	100			
59	00	00000000	0		Module revision		

Samsung Secret

Approval

5A	Detailed timing/monitor descriptor #3	00	00000000	0		ASCII Data String Tag
5B		00	00000000	0		
5C		00	00000000	0		
5D		FE	11111110	254		
5E		00	00000000	0		
5F		53	01010011	83	[S]	
60		41	01000001	65	[A]	
61		4D	01001101	77	[M]	
62		53	01010011	83	[S]	
63		55	01010101	85	[U]	
64		4E	01001110	78	[N]	
65		47	01000111	71	[G]	
66		0A	00001010	10	[^]	
67		20	00100000	32	[]	
68		20	00100000	32	[]	
69		20	00100000	32	[]	
6A	20	00100000	32	[]		
6B	20	00100000	32	[]		
6C	Detailed timing/monitor descriptor #4	00	00000000	0		Monitor Name Tag (ASCII)
6D		00	00000000	0		
6E		00	00000000	0		
6F		FE	11111110	254		
70		00	00000000	0		
71		31	00110001	49	[1]	
72		36	00110110	54	[6]	
73		30	00110000	48	[0]	
74		48	01001000	72	[H]	
75		54	01010100	84	[T]	
76		30	00110000	48	[0]	
77		31	00110001	49	[1]	
78		2D	00101101	45	[-]	
79		41	01000001	65	[A]	
7A		30	00110000	48	[0]	
7B		32	00110010	50	[2]	
7C	0A	00001010	10	[^]		
7D	20	00100000	32	[]		
7E	Extension Flag	00	00000000	0		
7F	Checksum	45	01000101	69		

Samsung Secret