

Property of Lite-On Only

Features

- * Package in 8mm tape on 7" diameter reels.
- * Compatible with automatic placement equipment.
- * Compatible with infrared and vapor phase reflow solder process.
- * EIA STD package.
- * I.C. compatible.
- * Meet green product and Pb-free(According to RoHS)

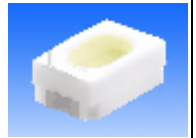

Package Dimensions

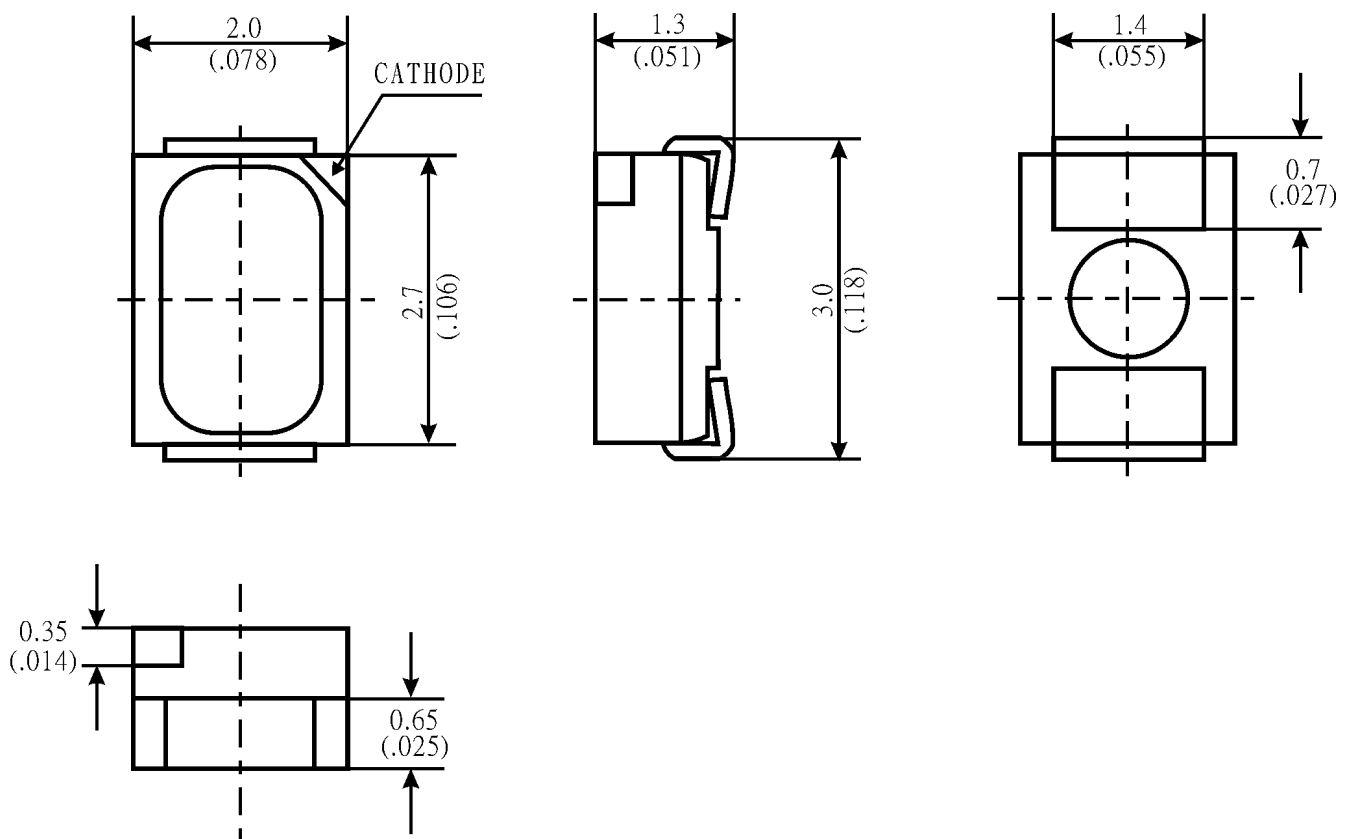

Part No.	Lens Color	Source Color
LTW-M670GS	Yellow	InGaN White

Notes:

1. All dimensions are in millimeters (inches).
2. Tolerance is ± 0.2 mm (.008") unless otherwise noted.

Property of Lite-On Only

Absolute Maximum Ratings at Ta=25°C

Parameter	LTW-M670GS	Unit
Power Dissipation	120	mW
Peak Forward Current (1/10 Duty Cycle, 0.1ms Pulse Width)	100	mA
DC Forward Current	30	mA
Reverse Voltage	5	V
Operating Temperature Range	-30°C to + 100°C	
Storage Temperature Range	-40°C to + 100°C	
Wave Soldering Condition	260°C For 5 Seconds	

Suggest IR Reflow Condition :

IR-Reflow Soldering Profile for lead free soldering (Acc. to J-STD-020B)

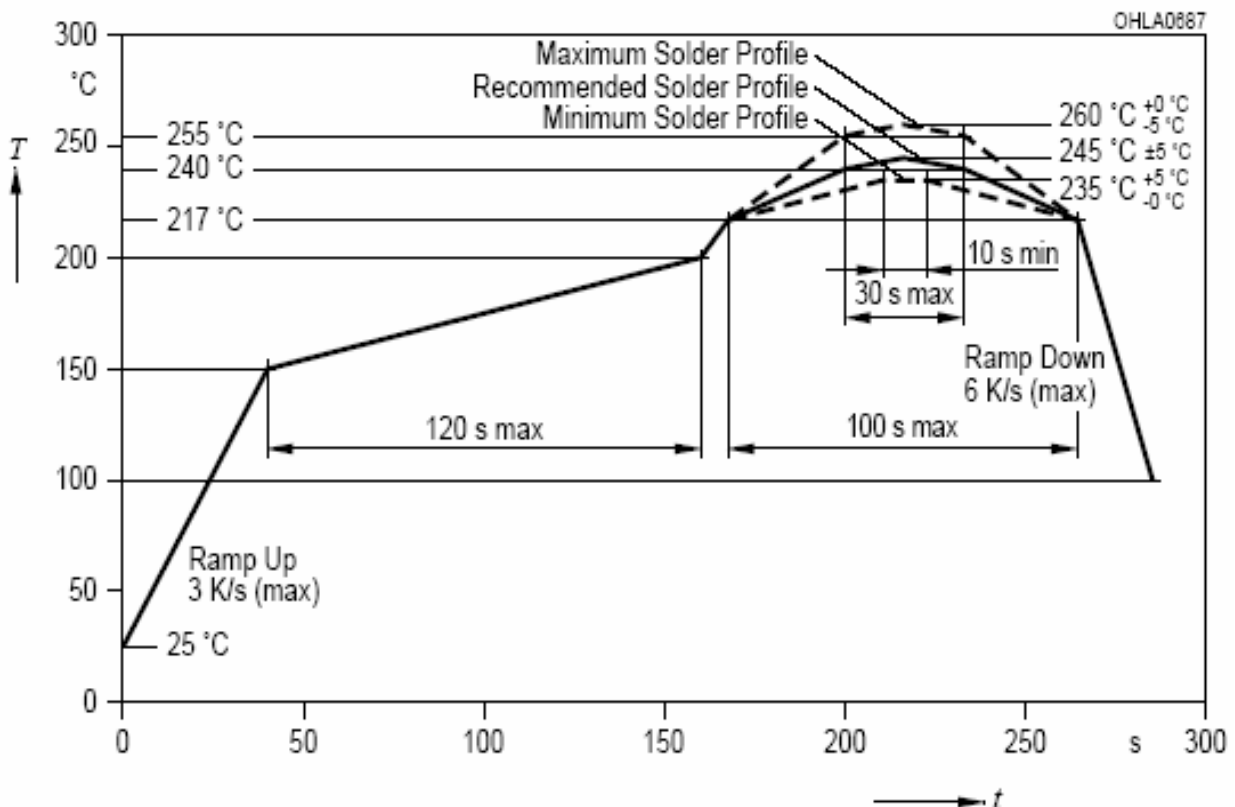

Property of Lite-On Only

Electrical Optical Characteristics At Ta=25°C

Parameter	Symbol	Part No. LTW-	Min.	Typ.	Max.	Unit	Test Condition
Luminous Intensity	I_V	M670GS	1500	1600		mcd	$I_F = 20\text{mA}$ Note 1, 2, 5
Luminous Flux	Φ_V	M670GS		4600		mlm	$I_F = 20\text{mA}$ Note 1, 2, 5
Viewing Angle	$2\theta 1/2$	M670GS		120		deg	Fig.6
Chromaticity Coordinates	x	M670GS		0.295			$I_F = 20\text{mA}$ Note 3, 5 Fig.1
	y			0.288			
Forward Voltage	V_F	M670GS	3.0	3.0	3.6	V	$I_F = 20\text{mA}$
ESD-Withstand Voltage	ESD	M670GS	2K			V	HBM

Note: 1. Luminous intensity is measured with a light sensor and filter combination that approximates the CIE eye-response curve.

2. Iv classification code is marked on each packing bag.

3. The chromaticity coordinates (x, y) is derived from the 1931 CIE chromaticity diagram.

4. Caution in ESD:

Static Electricity and surge damages the LED. It is recommended using a wrist band or anti-electrostatic glove when handling the LED. All devices, equipment and machinery must be properly grounded.

5. CAS140B is the test standard for the chromaticity coordinates (x, y) & IV.

6. The chromaticity coordinates (x, y) guarantee should be added ± 0.01 tolerance.

Property of Lite-On Only

Bin Code List

V _F Spec. Table		
VF Bin	Forward Voltage (V) at I _F = 20mA	
	Min.	Max.
V1	3.0	3.1
V2	3.1	3.2
V3	3.2	3.3
V4	3.3	3.4
V5	3.4	3.5
V6	3.5	3.6

Tolerance on each Forward Voltage bin is +/-0.10 volt

IV Spec. Table			
IV Bin	IV (mcd) at I _F = 20mA		Luminous Flux (mlm)
	Min.	Max.	Typ.
S5	1500	1600	4300
S6	1600	—1700	4600
S7	1700	1800	4900
S8	1800	1900	5200
S9	1900	2000	5500
T1	2000	2100	5800
T2	2100	2200	6100

Tolerance on each Luminous Intensity bin is +/- 10%.

Color Ranks Table					
Ranks	Color bin limits at I _F = 20mA				
	CIE 1931 Chromaticity coordinates				
A31	x	0.280	0.288	0.282	0.272
	y	0.248	0.262	0.272	0.258
A32	x	0.288	0.296	0.291	0.282
	y	0.262	0.276	0.287	0.272
A33	x	0.272	0.282	0.276	0.264
	y	0.258	0.272	0.282	0.267
A34	x	0.282	0.291	0.287	0.276
	y	0.272	0.287	0.295	0.282

Property of Lite-On Only

Color Ranks Table					
Ranks	Color bin limits at $I_F = 20\text{mA}$				
	CIE 1931 Chromaticity coordinates				
B51	x	0.296	0.291	0.300	0.304
	y	0.276	0.287	0.295	0.285
B52	x	0.304	0.300	0.309	0.311
	y	0.285	0.295	0.305	0.294
B53	x	0.291	0.287	0.297	0.300
	y	0.287	0.295	0.305	0.295
B54	x	0.300	0.297	0.307	0.309
	y	0.295	0.305	0.315	0.305
B6	x	0.311	0.307	0.33	0.33
	y	0.294	0.315	0.339	0.318
B7	x	0.291	0.279	0.302	0.308
	y	0.257	0.276	0.302	0.279
B8	x	0.308	0.302	0.319	0.321
	y	0.279	0.302	0.318	0.294

Tolerance on each Hue (x, y) bin is +/- 0.01.

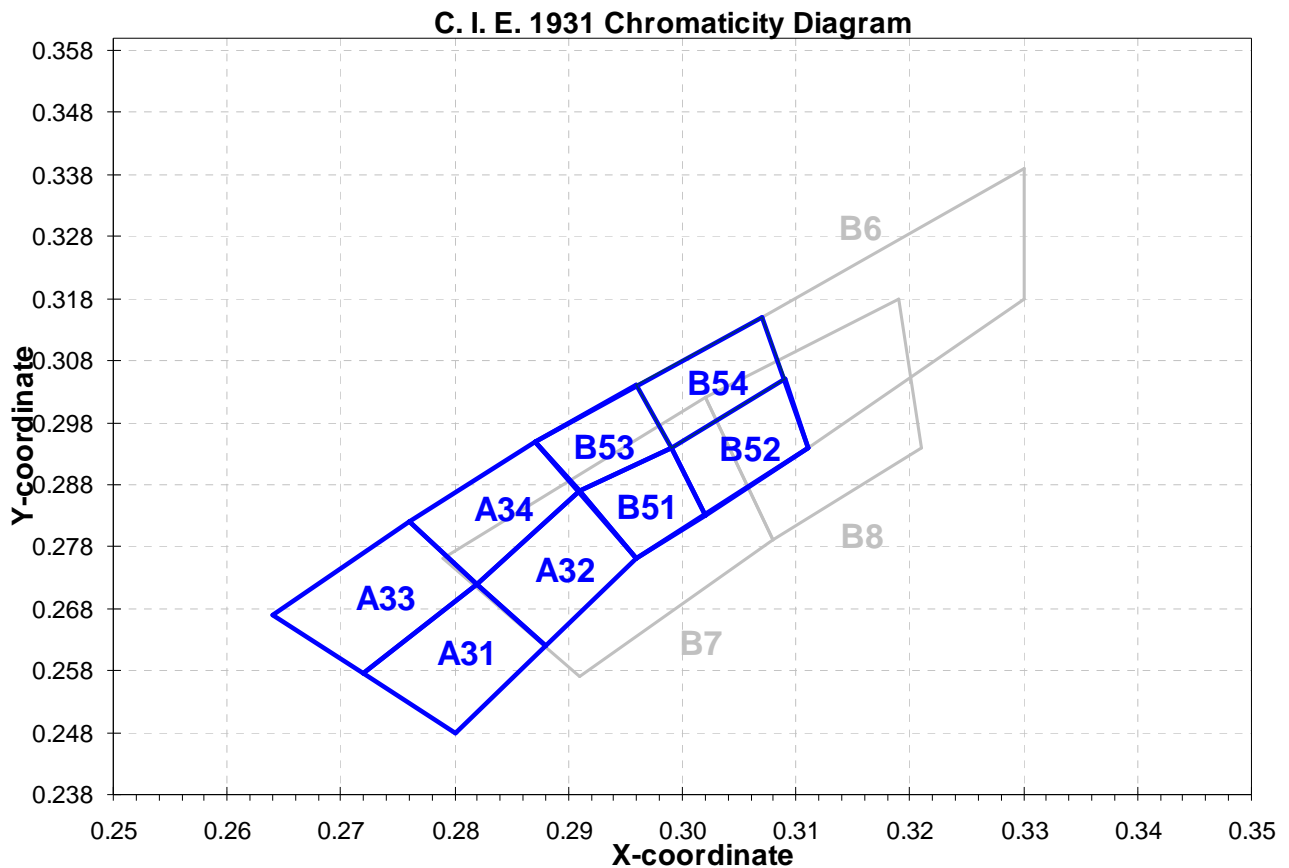

Property of Lite-On Only

Typical Electrical / Optical Characteristics Curves (25°C Ambient Temperature Unless Otherwise Noted)

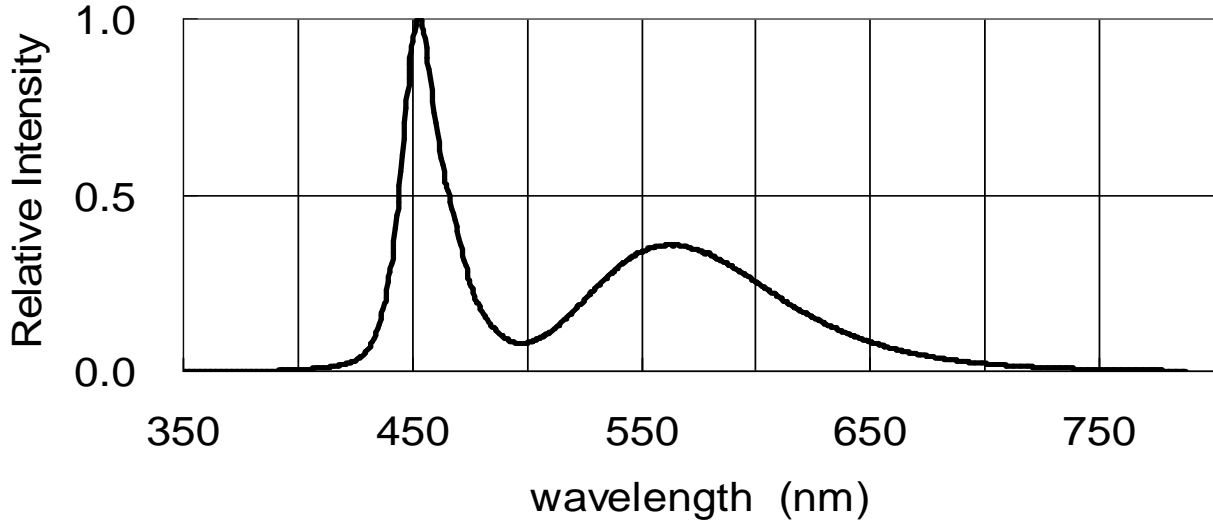

Fig.1 RELATIVE INTENSITY VS. WAVELENGTH

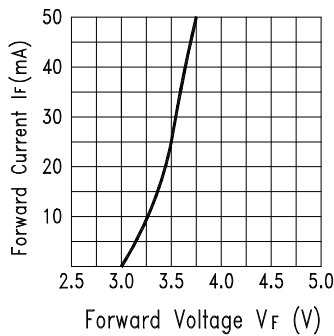

Fig.2 Forward Current vs. Forward Voltage

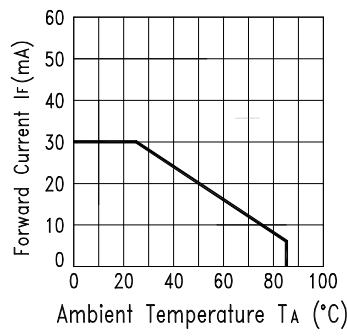

Fig.3 Forward Current Derating Curve

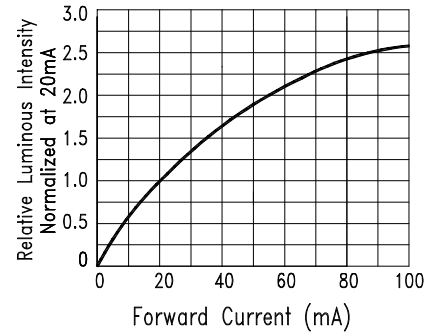

Fig.4 Relative Luminous Intensity vs. Forward Current

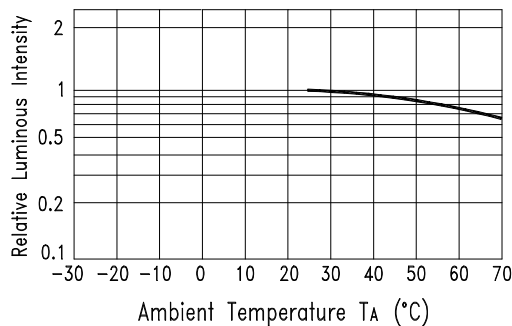

Fig.5 Luminous Intensity vs. Ambient Temperature

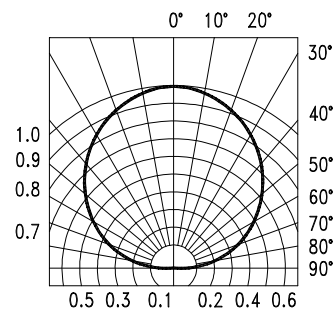

Fig.6 Spatial Distribution

Property of Lite-On Only

User Guide

Cleaning

Do not use unspecified chemical liquid to clean LED they could harm the package.

If cleaning is necessary, immerse the LED in ethyl alcohol or isopropyl alcohol at normal temperature for less than one minute.

Recommend Printed Circuit Board Attachment Pad

Infrared / vapor phase

Reflow Soldering

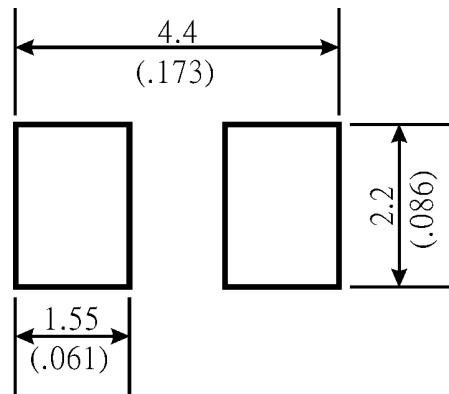

Package Dimensions of Tape

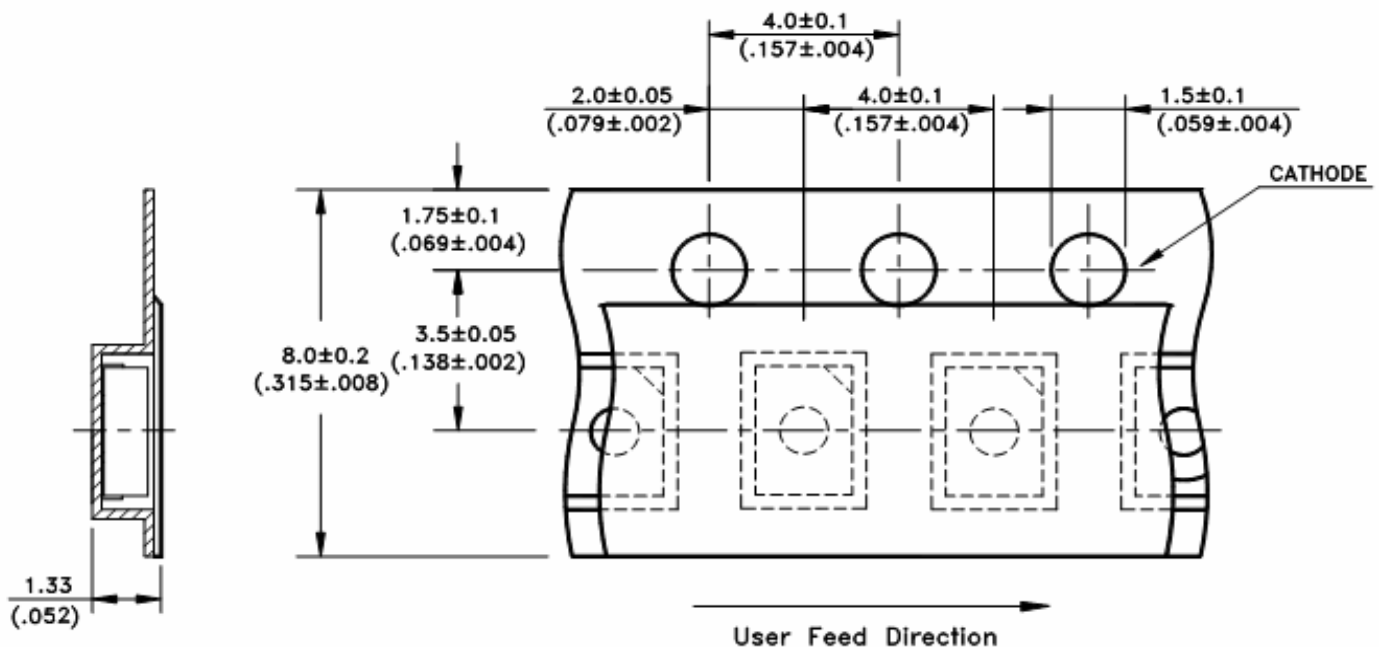

Note:

1. All dimensions are in millimeters (inches).

Property of Lite-On Only

Package Dimensions of Reel

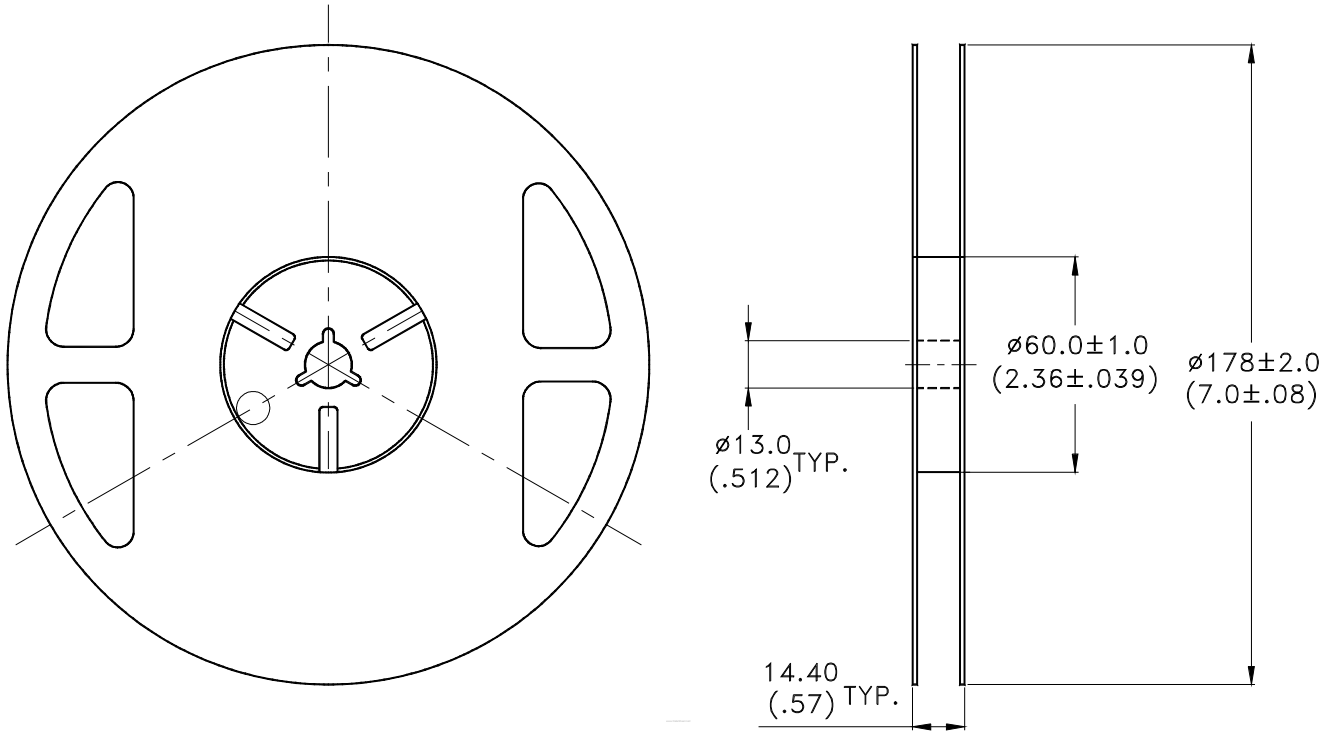

Notes:

1. Empty component pockets sealed with top cover tape.
2. 7 inch reel-2000 pieces per reel.
3. Minimum packing quantity is 500 pieces for remainders.
4. The maximum number of consecutive missing lamps is two.
5. In accordance with EIA-481-1-B specifications.

CAUTIONS

1. Application

The LEDs described here are intended to be used for ordinary electronic equipment (such as office equipment, communication equipment and household applications). Consult Liteon's Sales in advance for information on applications in which exceptional reliability is required, particularly when the failure or malfunction of the LEDs may directly jeopardize life or health (such as in aviation, transportation, traffic control equipment, medical and life support systems and safety devices).

2. Storage

The storage ambient for the LEDs should not exceed 30°C temperature or 70% relative humidity.

It is recommended that LEDs out of their original packaging are IR-reflowed within one week.

For extended storage out of their original packaging, it is recommended that the LEDs be stored in a sealed container with appropriate desiccant, or in desiccators with nitrogen ambient.

LEDs stored out of their original packaging for more than a week should be baked at about 60 deg C for at least 24 hours before solder assembly.

3. Cleaning

Use alcohol-based cleaning solvents such as isopropyl alcohol to clean the LED if necessary.

4. Soldering

Recommended soldering conditions:

Reflow soldering		Wave Soldering		Soldering iron	
Pre-heat	120~150°C	Pre-heat	100°C Max.	Temperature	300°C Max.
Pre-heat time	120 sec. Max.	Pre-heat time	60 sec. Max.	Soldering time	3 sec. Max.
Soldering Temp.	260°C Max.	Solder wave	260°C Max.		(one time only)
Soldering time	30 sec. Max.	Soldering time	10 sec. Max.		

5. Drive Method

An LED is a current-operated device. In order to ensure intensity uniformity on multiple LEDs connected in parallel in an application, it is recommended that a current limiting resistor be incorporated in the drive circuit, in series with each LED as shown in Circuit A below.

Circuit model A

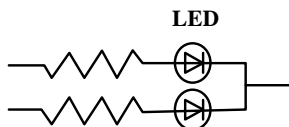

(A) Recommended circuit.

Circuit model B

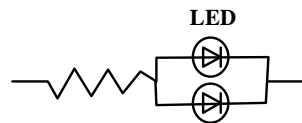

(B) The brightness of each LED might appear different due to the differences in the I-V characteristics of those LEDs.

6. ESD (Electrostatic Discharge)

Static Electricity or power surge will damage the LED.

Suggestions to prevent ESD damage:

- Use of a conductive wrist band or anti-electrostatic glove when handling these LEDs.
- All devices, equipment, and machinery must be properly grounded.
- Work tables, storage racks, etc. should be properly grounded.
- Use ion blower to neutralize the static charge which might have built up on surface of the LED's plastic lens as a result of friction between LEDs during storage and handling.

Property of Lite-On Only

ESD-damaged LEDs will exhibit abnormal characteristics such as high reverse leakage current, low forward voltage, or “no lightup” at low currents.

To verify for ESD damage, check for “light up” and Vf of the suspect LEDs at low currents.

The Vf of “good” LEDs should be >2.0V@0.1mA for InGaN product and >1.4V@0.1mA for AlInGaP product.

7. Reliability Test

Test Item	Test Condition	Reference Standard	Note	Number of Damaged
Resistance to Soldering Heat (Reflow Soldering)	Tsld=260°C, 10sec. (Pre treatment 30°C,70%,168hrs.)	JEITA ED-4701 300 301	2 times	0/50
Solderability (Reflow Soldering)	Tsld=245±5°C, 3sec. (Lead Free Solder)	JEITA ED-4701 300 303	1 time Over 95%	0/50
Thermal Shock	0°C ~ 100°C 15sec. 15sec. .	JEITA ED-4701 300 307	20 cycles	0/50
Temperature Cycle	-40°C ~ 25°C ~ 100°C ~ 25°C 30min. 5min. 30min. 5min.	JEITA ED-4701 100 105	100 cycles	0/50
Moisture Resistance Cyclic	25°C ~ 65°C ~ -10°C 90%RH 24HRS./1cycle	JEITA ED-4701 200 203	10 cycles	0/50
High Temperature Storage	Ta=100°C	JEITA ED-4701 200 201	1000 hrs.	0/50
Temperature Humidity Storage	Ta=60°C, RH=90%	JEITA ED-4701 100 103	1000 hrs.	0/50
Low Temperature Storage	Ta=-40°C	JEITA ED-4701 200 202	1000 hrs.	0/50
Steady State Operating Life Condition 1	Ta=25°C, IF=20mA		1000 hrs.	0/50
Steady State Operating Life Condition 2	Ta=25°C, IF=30mA		500 hrs.	0/50
Steady State Operating Life of High Temperature	Ta=85°C, IF=5mA		1000 hrs.	0/50
Steady State Operating Life of High Humidity Heat	60°C, RH=90%, IF=15mA		500 hrs.	0/50
Steady State Operating Life of low Temperature	Ta=-30°C, IF=20mA		1000 hrs.	0/50
Vibration	100~2000~100Hz Sweep 4 min. 200m/s ² 3 direction, 4 cycles	JEITA ED-4701 400 403	48 min.	0/50
Substrate Bending	3 mm, 5±1 sec.	JEITA ED-4702	1 time	0/50
Stick	5N, 10±1 sec.	JEITA ED-4702	1 time	0/50

8. Others

The appearance and specifications of the product may be modified for improvement without prior notice.

9. Quality Guarantee

LiteOn guarantee DPPM level of function failure is smaller and equal to 50 DPPM.

(Based on 100k usage)

10. Suggested Checking List**Training and Certification**

1. Everyone working in a static-safe area is ESD-certified?
2. Training records kept and re-certification dates monitored?

Static-Safe Workstation & Work Areas

1. Static-safe workstation or work-areas have ESD signs?
2. All surfaces and objects at all static-safe workstation and within 1 ft measure less than 100V?
3. All ionizer activated, positioned towards the units?
4. Each work surface mats grounding is good?

Personnel Grounding

1. Every person (including visitors) handling ESD sensitive (ESDS) items wear wrist strap, heel strap or conductive shoes with conductive flooring?
2. If conductive footwear used, conductive flooring also present where operator stand or walk?
3. Garments, hairs or anything closer than 1 ft to ESD items measure less than 100V*?
4. Every wrist strap or heel strap/conductive shoes checked daily and result recorded for all DLs?
5. All wrist strap or heel strap checkers calibration up to date?

Note: *50V for Blue LED.

Device Handling

1. Every ESDS items identified by EIA-471 labels on item or packaging?
2. All ESDS items completely inside properly closed static-shielding containers when not at static-safe workstation?
3. No static charge generators (e.g. plastics) inside shielding containers with ESDS items?
4. All flexible conductive and dissipative package materials inspected before reuse or recycle?

Others

1. Audit result reported to entity ESD control coordinator?
2. Corrective action from previous audits completed?
3. Are audit records complete and on file?