

LUH100G1202
LUH100G1202Z⁽¹⁾

SUSPMTM

1200V 100A 2-Pack IGBT Module

Features

Non Punch Through (NPT) Technology

- UltraFast
- 10 μ s Short Circuit current
- Positive $V_{CE(on)}$ Temperature Coefficient
- Square RBSOA
- Free Wheeling Diodes with fast and soft reverse recovery
- Industrial standard package with copper base plate
- Included ESD protection function ⁽¹⁾

Applications

- Welder / Power Supply
- UPS / Inverter
- Industrial Motor Drive

Preliminary data

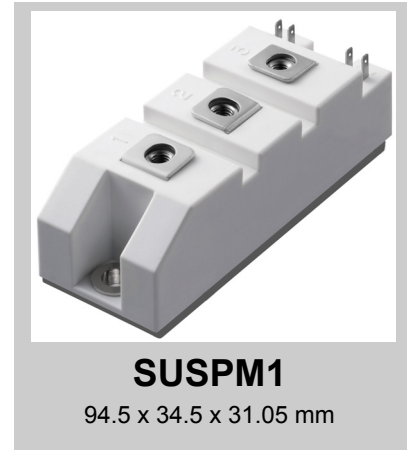

Absolute Maximum Ratings $T_C = 25^\circ\text{C}$ unless otherwise noted

Item	Symbol	Conditions	Value	Units
IGBT	V_{CES}		1200	V
	V_{GES}		± 20	V
	I_C	@ $T_J = 150^\circ\text{C}$, $T_C = 25^\circ\text{C}$, Continuous	140	A
		@ $T_J = 150^\circ\text{C}$, $T_C = 65^\circ\text{C}$, Continuous	100	A
	I_{CM}	@ $T_C = 80^\circ\text{C}$, $t_p=1\text{ms}$	200	A
	T_{SC}	Chip Level, @ $T_J = 150^\circ\text{C}$, $V_{GE} = 15\text{V}$, $V_{CES} < 1200\text{V}$	10	μs
	T_J	Operating Junction Temperature ⁽²⁾	-40~125	$^\circ\text{C}$
P_D	@ $T_J = 150^\circ\text{C}$, $T_C = 25^\circ\text{C}$	560	W	
	@ $T_J = 150^\circ\text{C}$, $T_C = 80^\circ\text{C}$	310	W	
Diode	V_{RRM}		1200	V
	I_F	@ $T_C = 25^\circ\text{C}$	-	A
		@ $T_C = 80^\circ\text{C}$	-	A
	I_{FRM}	@ $T_C = 80^\circ\text{C}$, $t_p=1\text{ms}$	-	A
	T_J	Operating Junction Temperature ⁽²⁾	-40~125	$^\circ\text{C}$
P_D	@ $T_C = 25^\circ\text{C}$	-	W	
	@ $T_C = 80^\circ\text{C}$	-	W	
Module	T_{stg}	Storage Temperature	-40~125	$^\circ\text{C}$
	V_{iso}	@AC 1minute	2500	V
	M_t	Main Terminal Mounting torque(M5)	2.5~5	Nm
	M_S	Heat sink Mounting torque(M6)	3.0~5	Nm
	W	Weight	180	g

Internal Circuit & Pin Description

Pin Number	Pin Name	Pin Description
1	C2E1	Output
2	E2	Negative DC Link Output
3	C1	Positive DC Link Output
4	G1	Gate Input for High-side
5	E1	Emitter Input for High-side
6	G2	Gate Input for Low-side
7	E2	Emitter Input for Low-side

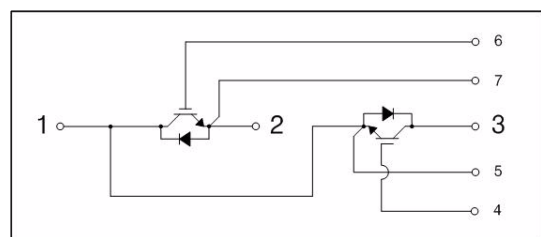

(Note *1) Option : Included $\pm 28\text{V}$ Zener Diode between Gate and Emitter
(Note *2) The Maximum junction temperature of chip is 150°C

Electrical Characteristics of IGBT $T_C = 25^\circ\text{C}$ unless otherwise noted

Static Characteristics

Symbol	Parameter	Test Conditions	Min	Typ	Max	Units
BV_{CES}	C-E Breakdown Voltage	$V_{GE} = 0V, I_C = 1mA$	600	-	-	V
I_{CES}	C-E Cut-Off Current	$V_{CE} = V_{CES}, V_{GE} = 0V$	-	-	1	mA
I_{GES}	G-E Leakage Current	$V_{GE} = V_{GES}, V_{CE} = 0V$	-	-	-	nA
$V_{GE(th)}$	G-E Threshold Voltage	$V_{GE} = V_{CE}, I_C = 100mA$	-	6.02	-	V
$V_{CE(sat)}$	Collector to Emitter Saturation Voltage	$I_C = 100A, V_{GE} = 15V, T_C = 25^\circ\text{C}$	-	3.35	-	V
		$I_C = 100A, V_{GE} = 15V, T_C = 125^\circ\text{C}$	-	3.98	-	V

Dynamic Characteristics

Symbol	Parameter	Test Conditions	Min	Typ	Max	Units
C_{ies}	Input Capacitance	$V_{CE} = 25V, V_{GE} = 0V$ $f = 1MHz, T_C = 25^\circ\text{C}$	-	-	-	nF
C_{oes}	Output Capacitance		-	-	-	nF
C_{res}	Reverse Transfer Capacitance		-	-	-	nF
$t_d(on)$	Turn-On Delay Time	$T_C = 125^\circ\text{C}, R_G = 10\ \Omega$ $L = 100\ \mu H, V_{DC} = 600V$ $V_{GE} = 15V \sim -15V$ $I_C = 100A$	-	128	-	ns
t_r	Rise Time		-	55	-	ns
$t_d(off)$	Turn-Off Delay Time		-	530	-	ns
t_f	Fall Time		-	48	-	ns
E_{on}	Turn-On Switching Loss		-	11.7	-	mJ
E_{off}	Turn-Off Switching Loss		-	5.0	-	mJ
E_{is}	Total Switching Loss		-	16.7	-	mJ
Q_g	Total Gate Charge	$V_{GE} = 0V \sim +15V$	-	830	-	nC
Q_{ge}	Gate-Emitter Charge		-	190	-	nC
Q_{gc}	Gate-Collector Charge		-	300	-	nC

Electrical Characteristics of Diode $T_C = 25^\circ\text{C}$ unless otherwise noted

Symbol	Parameter	Test Conditions	Min	Typ	Max	Units	
V_F	Diode Forward Voltage	$I_F = 100A, V_{GE} = 0V$	$T_C = 25^\circ\text{C}$	-	1.84	-	V
			$T_C = 125^\circ\text{C}$	-	1.82	-	
t_{rr}	Diode Reverse Recovery Time	$R_G = 10\ \Omega$ $L = 100\ \mu H$ $V_{DC} = 600V$ $V_{GE} = 15V \sim -15V$ $I_C = 100A$	$T_C = 25^\circ\text{C}$	-	290	-	ns
			$T_C = 125^\circ\text{C}$	-	580	-	
I_{RRM}	Diode Peak Reverse Recovery Current		$T_C = 25^\circ\text{C}$	-	98	-	A
			$T_C = 125^\circ\text{C}$	-	115	-	
Q_{rr}	Diode Reverse Recovery Charge		$T_C = 25^\circ\text{C}$	-	10.1	-	μC
			$T_C = 125^\circ\text{C}$	-	23.1	-	
E_{rr}	Diode Reverse Recovery Energy	$T_C = 25^\circ\text{C}$	-	3.4	-	mJ	
		$T_C = 125^\circ\text{C}$	-	8.9	-		

Thermal Characteristics

Symbol	Parameter	Test Conditions	Min	Typ	Max	Units
$R_{th(J-C)}$	Thermal Resistance (IGBT Part)	Junction-to-Case	-	0.22	-	$^\circ\text{C/W}$
$R_{th(J-C)D}$	Thermal Resistance (Diode Part)	Junction-to-Case	-	-	-	$^\circ\text{C/W}$

* This specifications may not be considered as an assurance of characteristics and may not have same characteristics in case of using different test systems from@LSIS. We therefore strongly recommend prior consultation of our engineers.

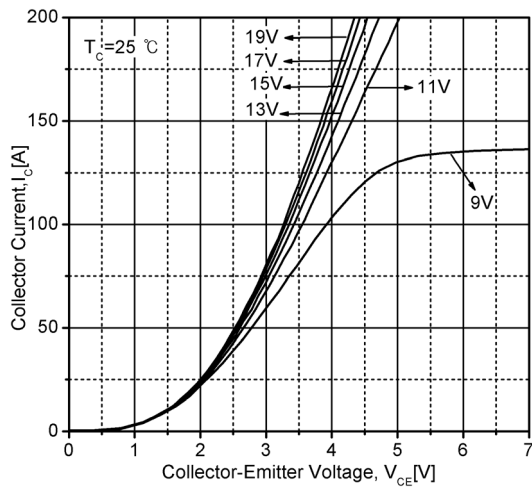

Fig 1. Typical IGBT Output Characteristics

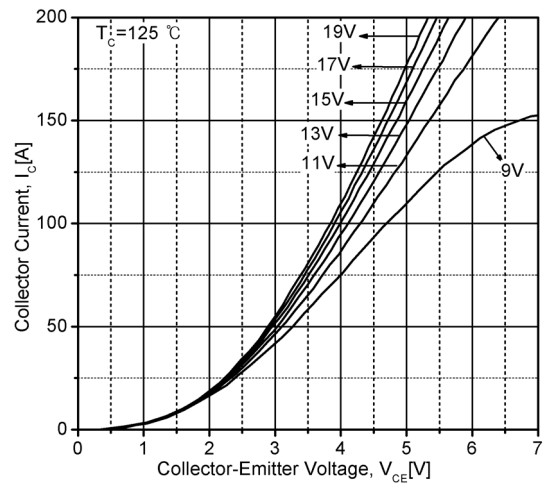

Fig 2. Typical IGBT Output Characteristics

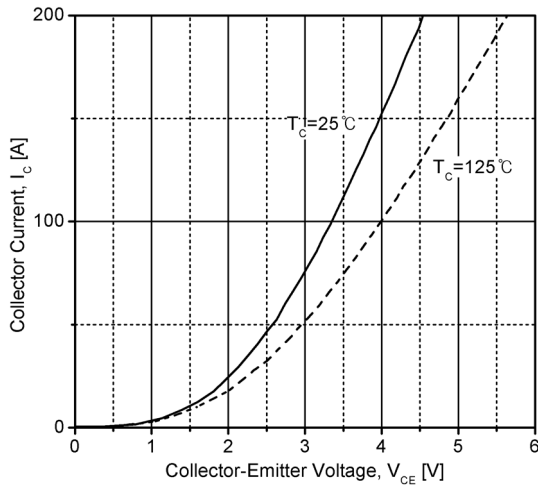

Fig 3. Typical IGBT Output Characteristics

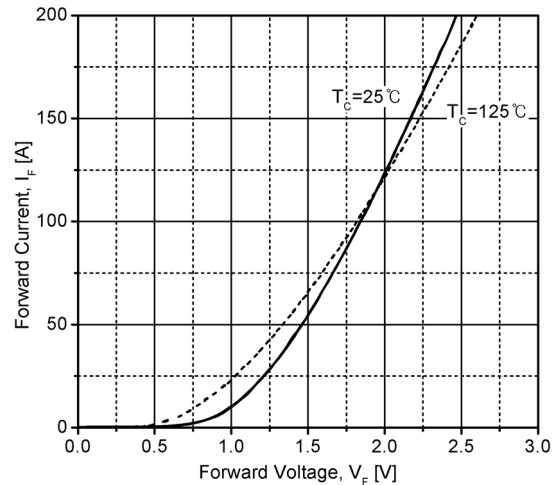

Fig 4. Typical Diode Forward Characteristics

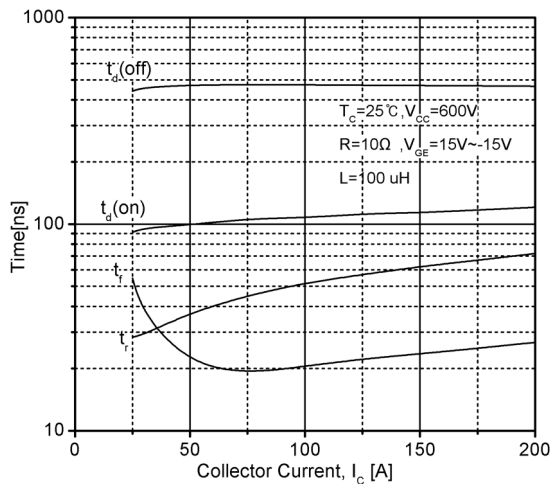

Fig 5. Typical Switching Time vs. Collector Current

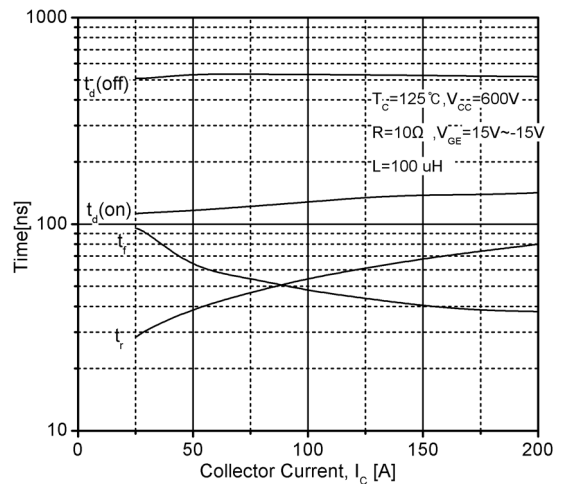

Fig 6. Typical Switching Time vs. Collector Current

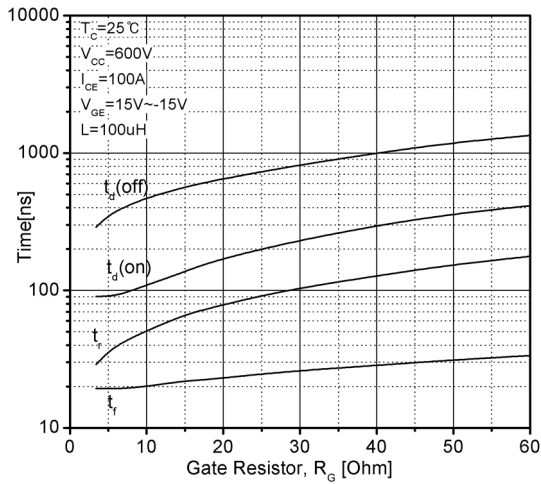

Fig 7. Typical Switching Time vs. Gate Resistor

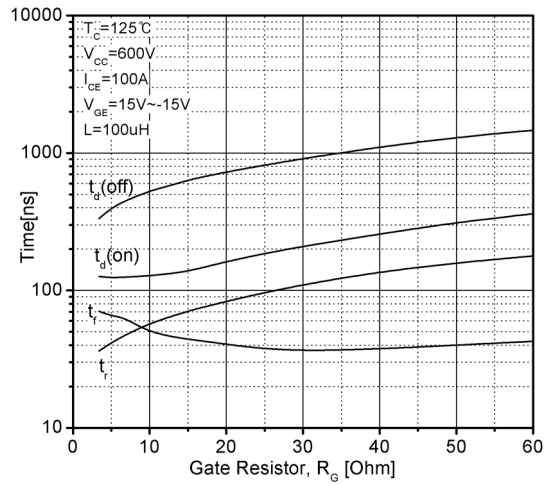

Fig 8. Typical Switching Time vs. Gate Resistor

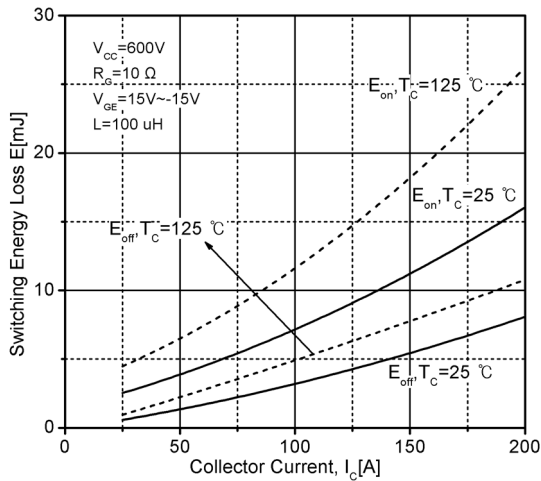

Fig 9. Typical IGBT Switching Loss

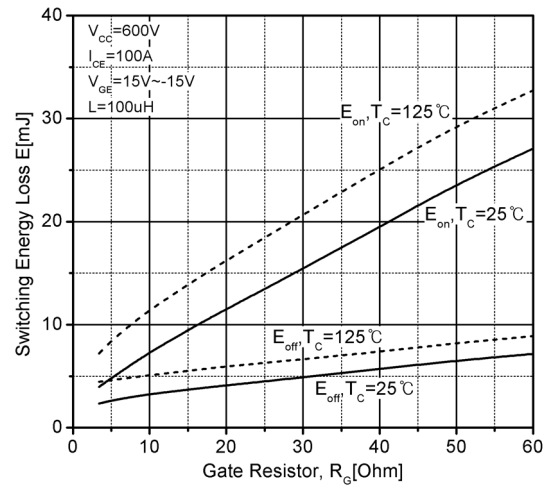

Fig 10. Typical IGBT Switching Loss

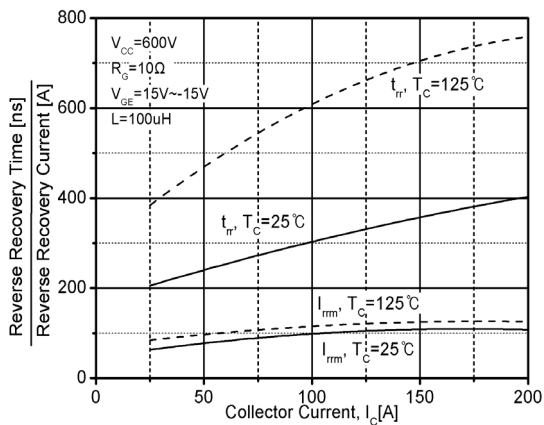

Fig 11. Typical Recovery Characteristics of Diode

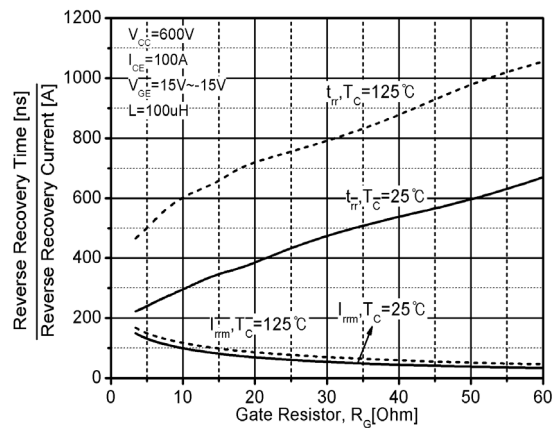

Fig 12. Typical Recovery Characteristics of Diode

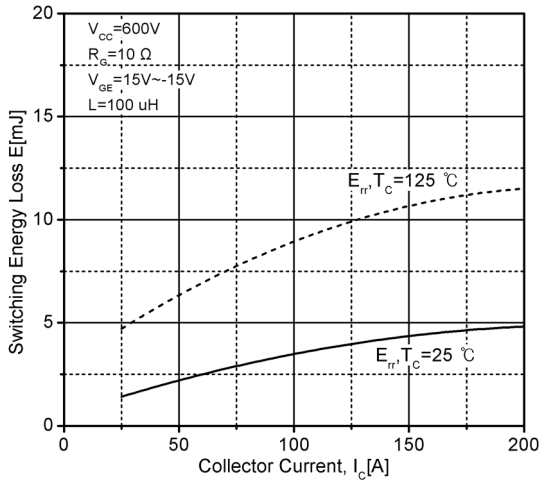

Fig 13. Typical Diode Switching Loss

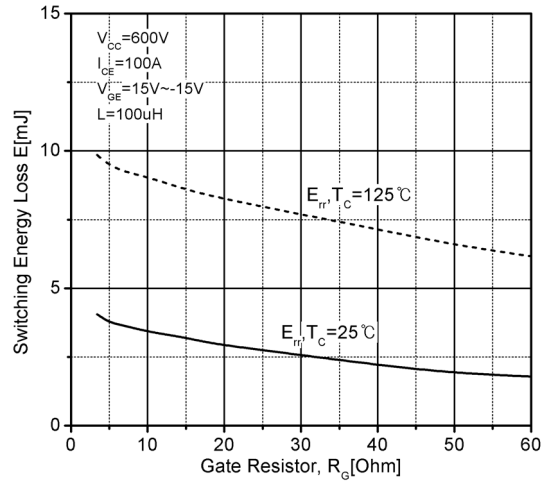

Fig 14. Typical Diode Switching Loss

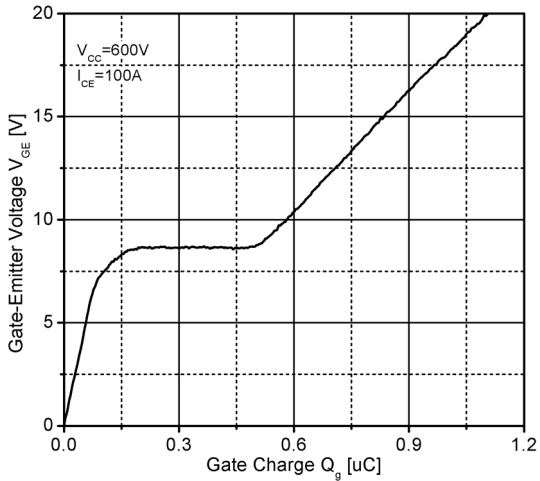

Fig 15. Typical Gate Charge Characteristics

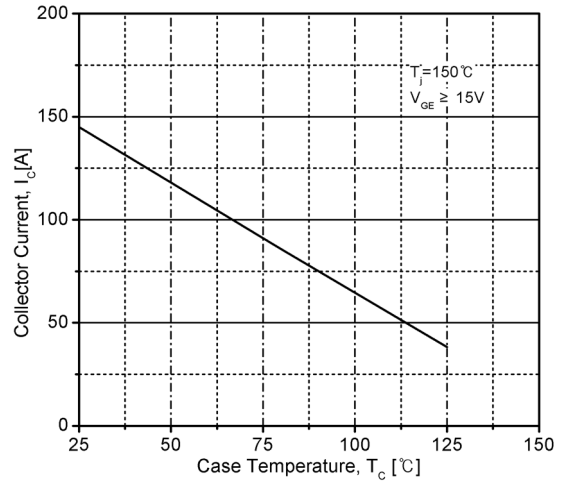

Fig 16. Case Temperature vs. Collector Current

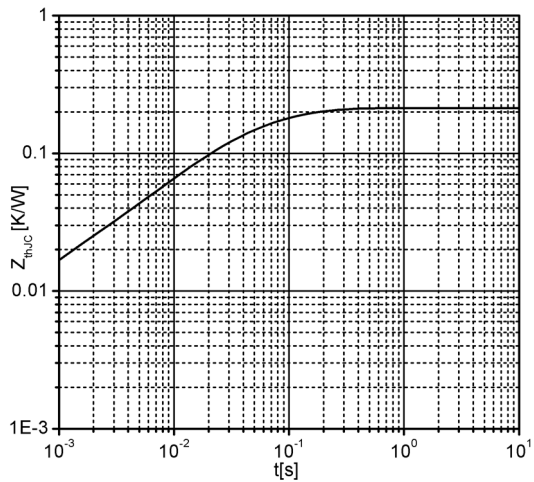
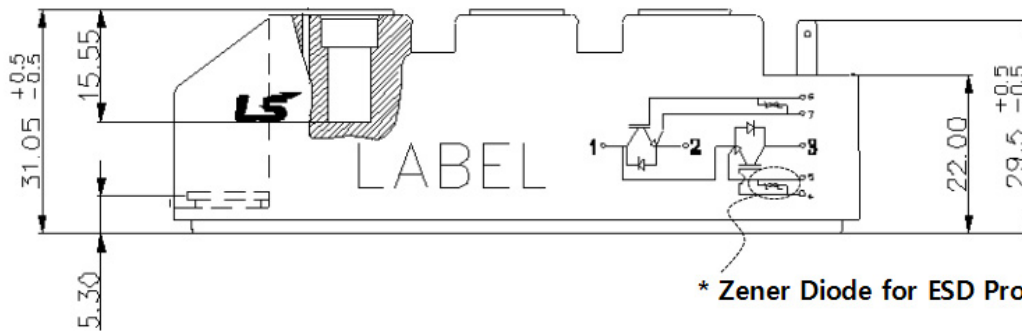
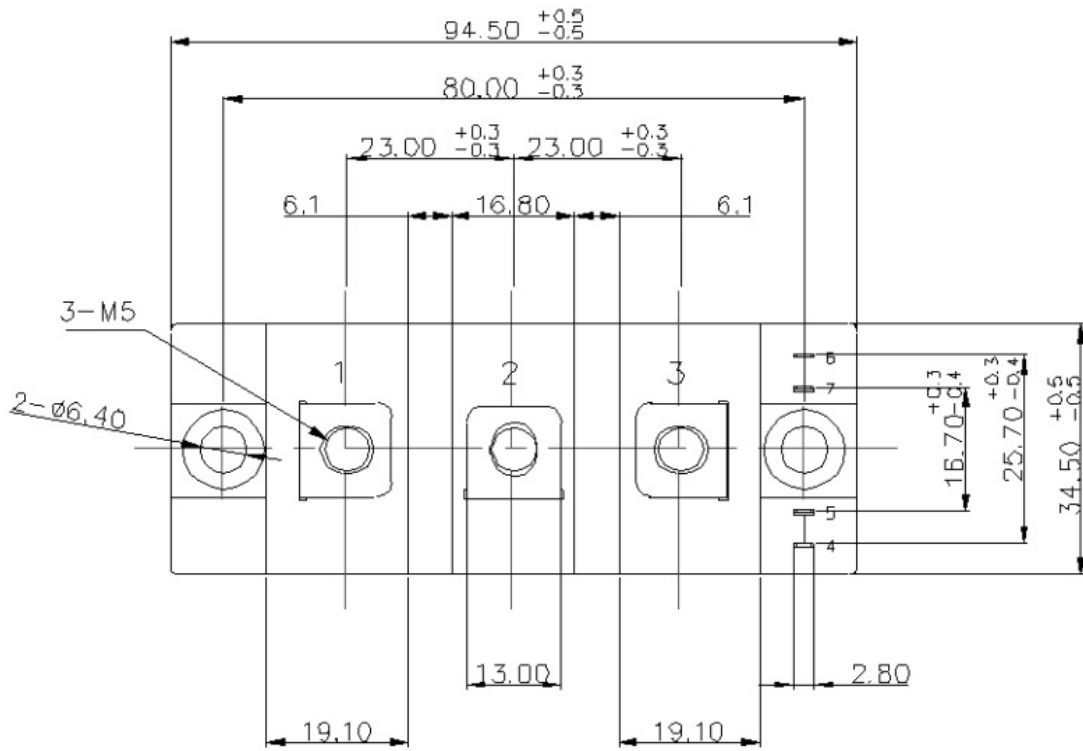

Fig 17. Typical Transient Thermal Impedance

Package Dimension(Dimension in mm)



* Zener Diode for ESD Protection.