

# 16×32 dot matrix unit

## LUM-512HML303

The LUM-512HML303 is a 16×32 dot matrix display which can be used in a wide range of applications, including alphabet, numeric, symbol and graphical displays. A large display can be easily created by arranging a number of these dot matrix displays in an array, and they can be applied to a variety of display purposes. A custom LSI controller has display data memory for two screens, and data for each screen can be written and displayed in turn.

### ●Applications

Light source for displays

### ●Features

- 1) 16×32 dot matrix.  
Shape of emitting section : □2.1×2.3
- 2) Dimensions : 64mm×128mm
- 3) Clear display.
- 4) Three-color display is possible  
(red, green, and orange).
- 5) 1 / 16 duty dynamic scan method.
- 6) Ultra-thin shape of 9.1mm, light weight of 90g, and wide directional characteristics of 100 degrees.

### ●Selection guide

Display Type	Chip LED
Type	LUM-512HML303

### ●External dimensions (Units : mm)

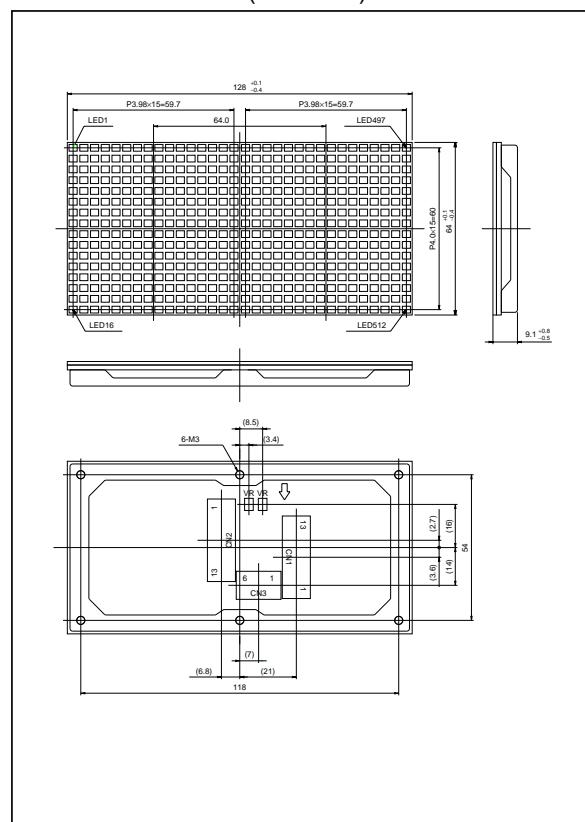

### ●Specifications

For specifications, refer to "LUM unit series".

([www.rohm.com/products/databook/dp/pdf/lum-unit.pdf](http://www.rohm.com/products/databook/dp/pdf/lum-unit.pdf))