

LV0111CF

Ambient Light Sensor, Logarithmic Current Output, with Standby Function



ON Semiconductor[®]
www.onsemi.com

Overview

LV0111CF is a Photo IC for ultra-small package ambient light sensor which has the characteristics of spectral response similar to that of human eyes. It is suitable for the applications like mobile phone (for Digital-TV, One-segment), LCD-TV, laptop computer, PDA, DSC and Camcorder. It is goods for a free halogen.

Features

- Logarithm current output
- Excellent luminous efficiency function
- Built-in sleep function
- Low current consumption

Typical Applications

- Ambient Light Sensor
- Feature phone, Smart phone, ...
- Digital TV : (CRT, LCD, OLED, ...)
- DSC, DVC, DSLR, Mirrorless, ...

SPECIFICATION

ABSOLUTE MAXIMUM RATINGS at Ta = 25°C (Note 1)

Parameter	Symbol	Conditions	Ratings	Unit
Maximum supply voltage	V _{CC} max		6	V
Operating temperature	T _{opr}		-30 to +85	°C
Storage temperature	T _{stg}		-40 to +100	°C

1. Stresses exceeding those listed in the Absolute Maximum Rating table may damage the device. If any of these limits are exceeded, device functionality should not be assumed, damage may occur and reliability may be affected.

RECOMMENED OPERATING CONDITIONS AND

OPERATING VOLTAGE RANGE at Ta = 25°C (Note 2)

Parameter	Symbol	Conditions	Ratings			Unit
			min	typ	max	
Recommended supply voltage	V _{CC}		2.3	2.5	5.5	V
SW pin low voltage	V _I	Sleep mode	0		0.4	V
SW pin high voltage	V _h	Normal mode	1.5		V _{CC}	V

2. Functional operation above the stresses listed in the Recommended Operating Ranges is not implied. Extended exposure to stresses beyond the Recommended Operating Ranges limits may affect device reliability.

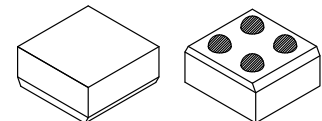

ODCSP4J 1.08 mm x 1.08 mm

ORDERING INFORMATION

Ordering Code:
LV0111CF-TLM-H

Package
ODCSP4J
(Pb-Free / Halogen Free)

Shipping (Qty / packing)
5000 / Tape & Reel

† For information on tape and reel specifications, including part orientation and tape sizes, please refer to our Tape and Reel Packaging Specifications Brochure, BRD8011/D.
http://www.onsemi.com/pub_link/Collateral/BRD8011-D.PDF

LV0111CF

ELECTRICAL AND OPTICAL CHARACTERISTICS at $T_a = 25^\circ\text{C}$, $V_{CC} = 2.5\text{V}$ (Note 3)

Parameter	Symbol	Conditions	Ratings			Unit
			min	typ	max	
Current dissipation (Note 4, 6)	I_{CC}	$E_v = 1000 \text{ lx}$, $R_L = 27\text{k}\Omega$	50	75	100	μA
Sleep current	I_{sl}	$E_v = 0 \text{ lx}$		0.01	0.1	μA
Output current (1) (Note 4, 6)	I_{O1}	$E_v = 100 \text{ lx}$	18	21	24	μA
Output current (2) (Note 4, 6)	I_{O2}	$E_v = 1000 \text{ lx}$	27	31	35	μA
Dark current	I_{leak}	$E_v = 0 \text{ lx}$		0.35	0.5	μA
Temperature coefficient (Note 5)	I_{tc}	$E_v = 100 \text{ lx}$		0.1		$\%/^\circ\text{C}$
Rise time (Note 7)	T_{r1}	$E_v = 1000 \text{ lx}$		40	100	μs
Fall time (Note 7)	T_{f1}	$E_v = 1000 \text{ lx}$		2	5	ms
Peak sensitivity wave length (Note 5)	λ_p			550		nm

3. Product parametric performance is indicated in the Electrical Characteristics for the listed test conditions, unless otherwise noted. Product performance may not be indicated by the Electrical Characteristics if operated under different conditions.

4. Measured with the standard light source A. White LED is used instead in the mass production line.

5. Design guaranteed item

6. Test circuit for measuring current dissipation and output current

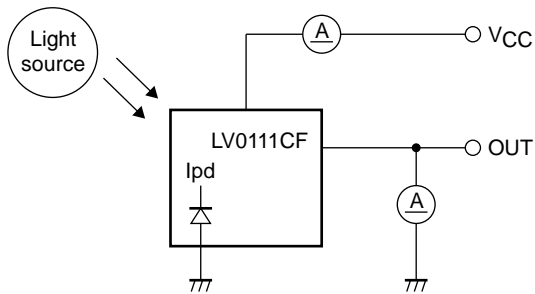

7. Measuring method of rise time (T_r) and fall time (T_f)

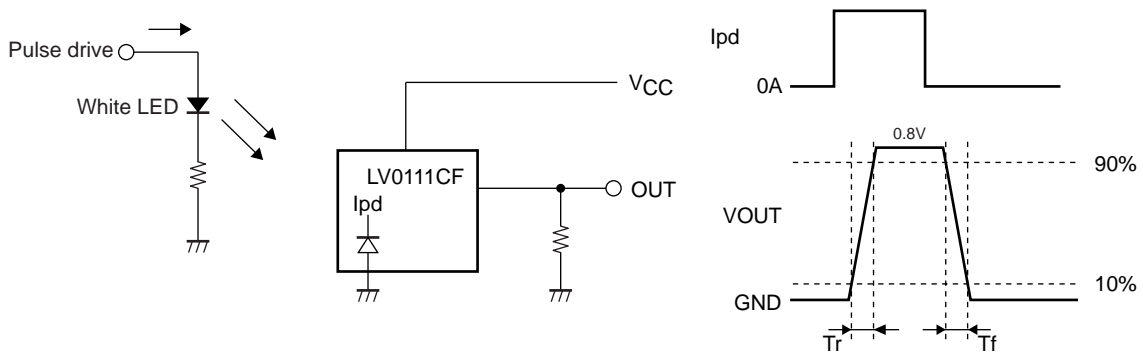

LV0111CF

PAD LAYOUT

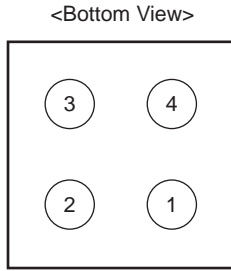
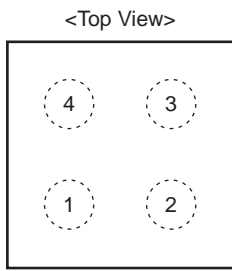

Pin No.	Pin Name	Function
1	VCC	Power supply
2	EN	Enable
3	GND	Ground
4	OUT	Output

Ball pitch : 0.5mm, Ball size : 0.25mm ϕ

PAD LAYOUT (Photos)

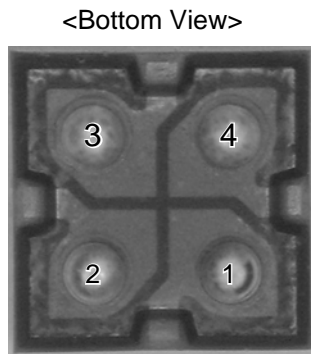
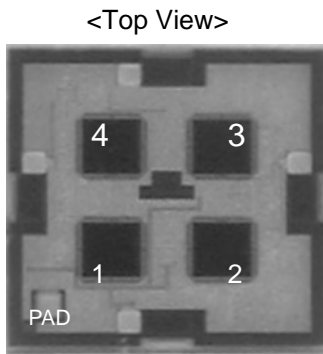

* The position with PAD becomes pin 1.

LV0111CF

Internal Block Diagram

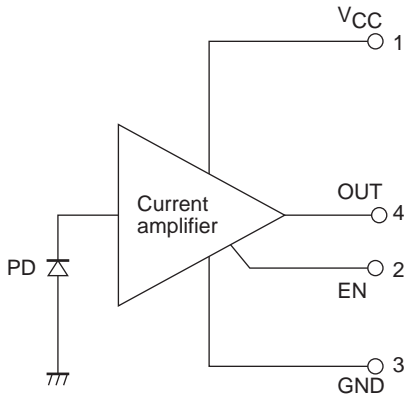

Chip Pattern Diagram

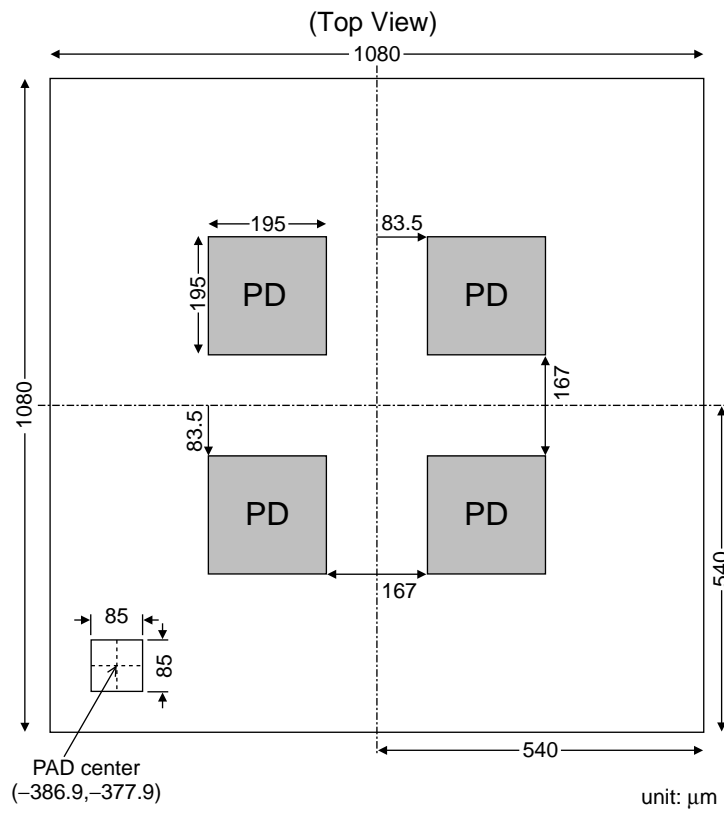

* The PAD becomes pin 1.

LV0111CF

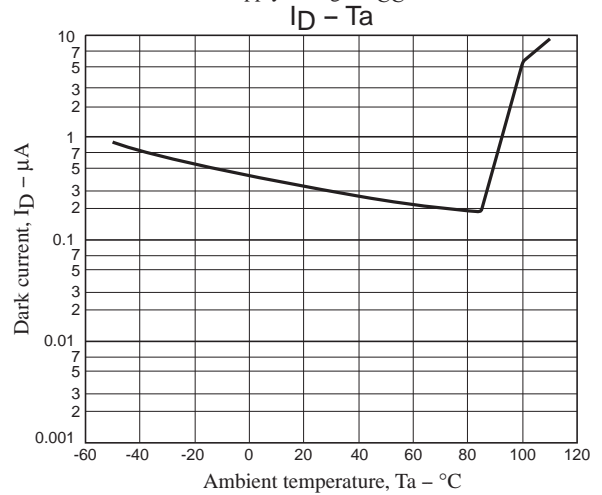
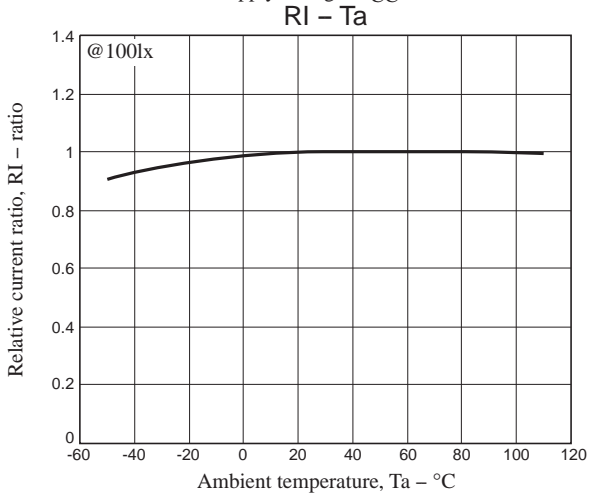
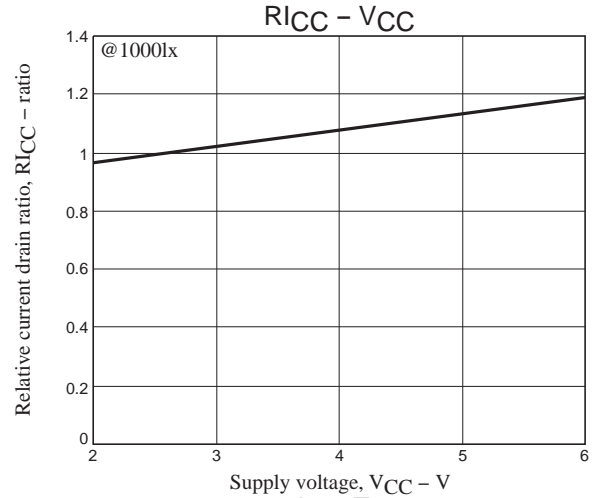
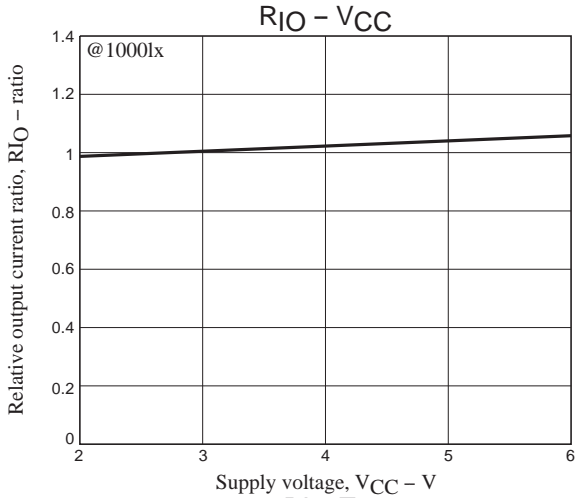
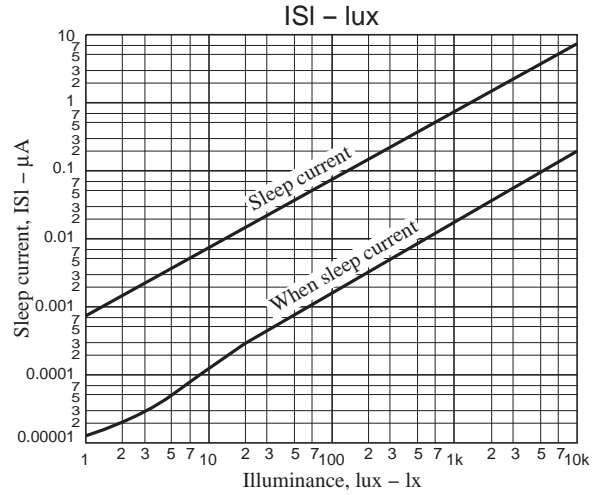
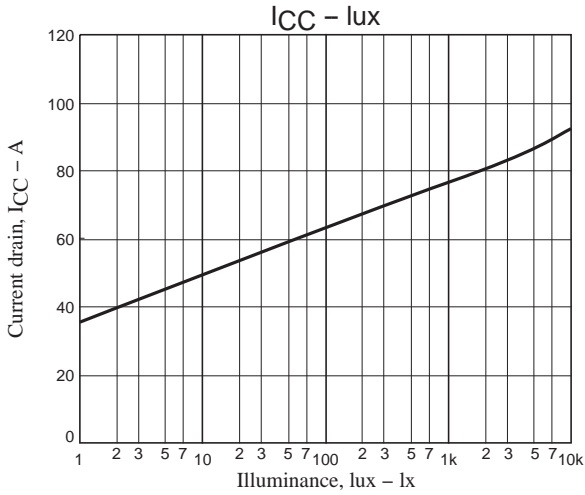
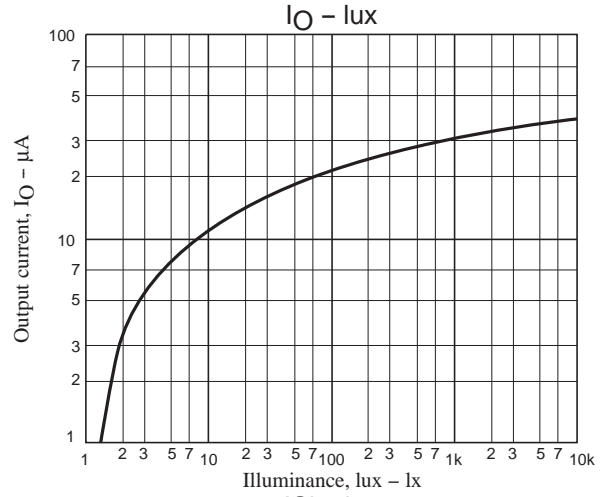
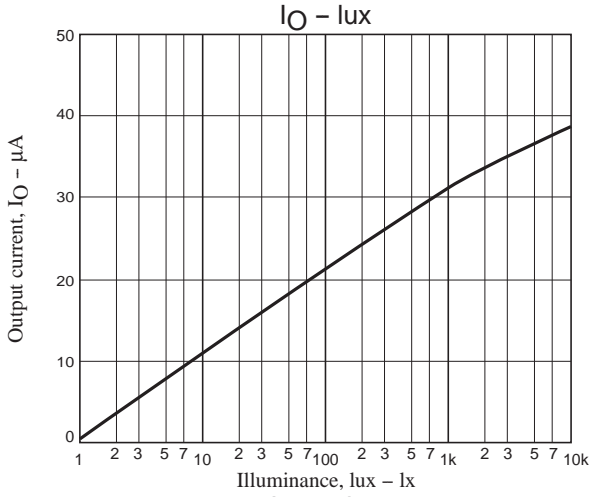

LV0111CF

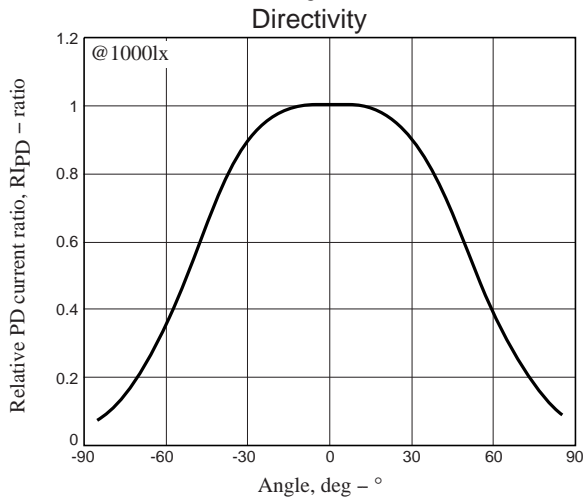
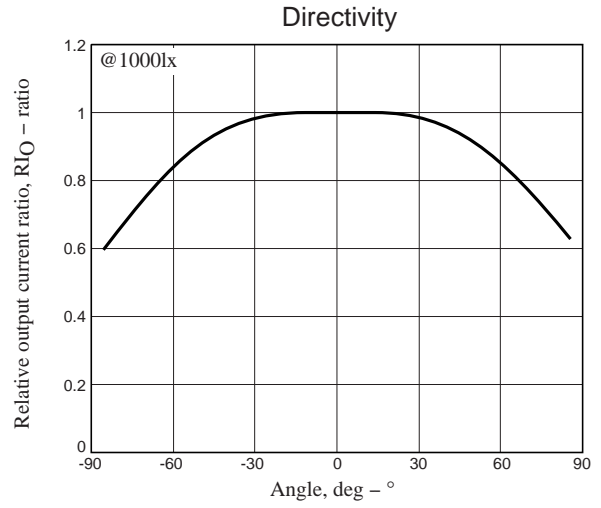
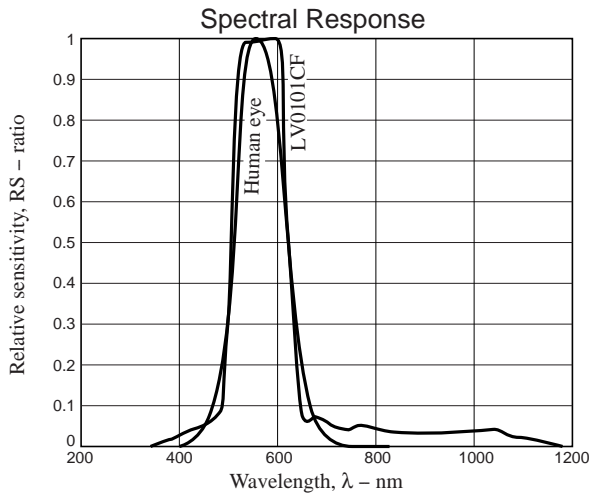

LV0111CF

PACKAGE DIMENSIONS

unit : mm

ODCSP4J 1.08x1.08
CASE 570AD
ISSUE O

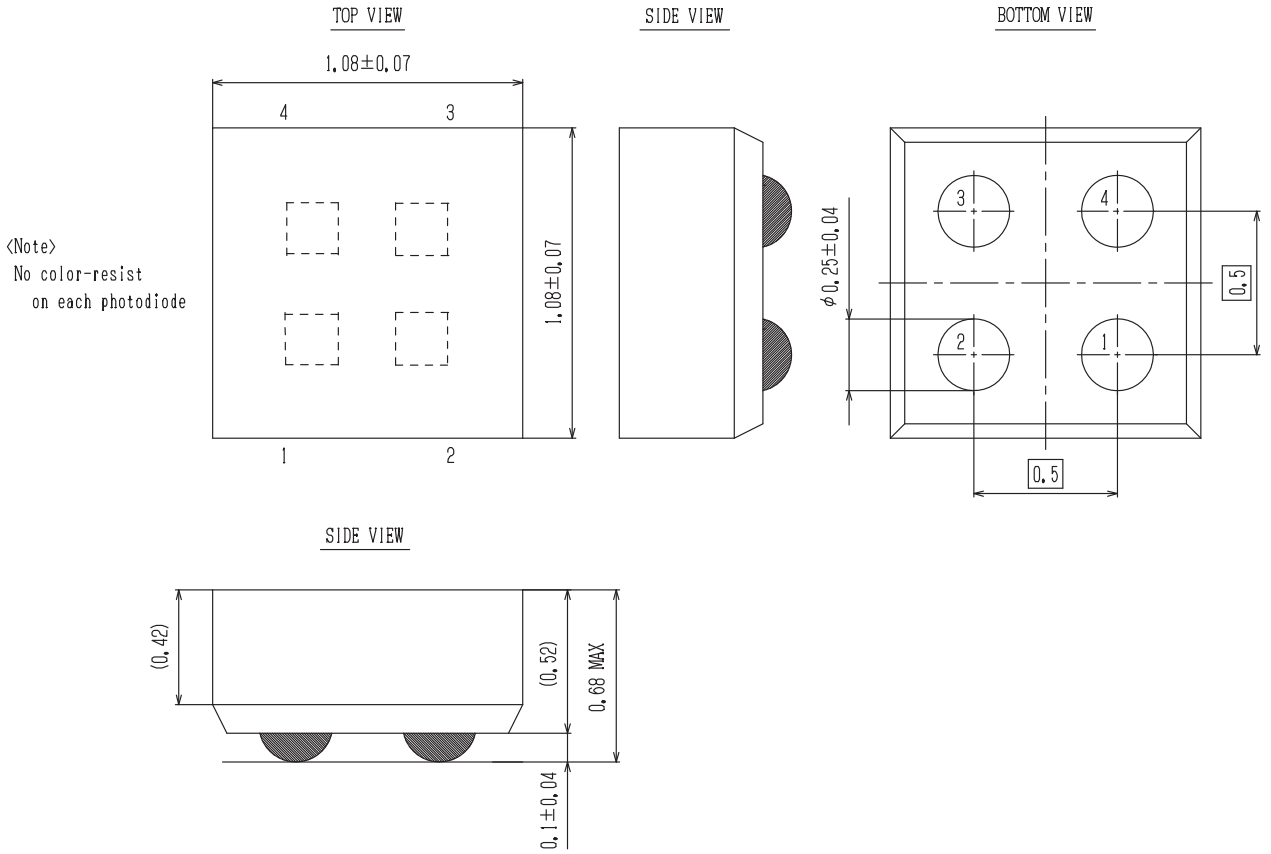

ON Semiconductor and the ON logo are registered trademarks of Semiconductor Components Industries, LLC (SCILLC) or its subsidiaries in the United States and/or other countries. SCILLC owns the rights to a number of patents, trademarks, copyrights, trade secrets, and other intellectual property. A listing of SCILLC's product/patent coverage may be accessed at www.onsemi.com/site/pdf/Patent-Marking.pdf. SCILLC reserves the right to make changes without further notice to any products herein. SCILLC makes no warranty, representation or guarantee regarding the suitability of its products for any particular purpose, nor does SCILLC assume any liability arising out of the application or use of any product or circuit, and specifically disclaims any and all liability, including without limitation special, consequential or incidental damages. "Typical" parameters which may be provided in SCILLC data sheets and/or specifications can and do vary in different applications and actual performance may vary over time. All operating parameters, including "Typicals" must be validated for each customer application by customer's technical experts. SCILLC does not convey any license under its patent rights nor the rights of others. SCILLC products are not designed, intended, or authorized for use as components in systems intended for surgical implant into the body, or other applications intended to support or sustain life, or for any other application in which the failure of the SCILLC product could create a situation where personal injury or death may occur. Should Buyer purchase or use SCILLC products for any such unintended or unauthorized application, Buyer shall indemnify and hold SCILLC and its officers, employees, subsidiaries, affiliates, and distributors harmless against all claims, costs, damages, and expenses, and reasonable attorney fees arising out of, directly or indirectly, any claim of personal injury or death associated with such unintended or unauthorized use, even if such claim alleges that SCILLC was negligent regarding the design or manufacture of the part. SCILLC is an Equal Opportunity/Affirmative Action Employer. This literature is subject to all applicable copyright laws and is not for resale in any manner.