

Voltage Transducer LV 100-1200

$$V_{PN} = 1200 \text{ V}$$

For the electronic measurement of voltages : DC, AC, pulsed..., with a galvanic isolation between the primary circuit (high voltage) and the secondary circuit (electronic circuit).

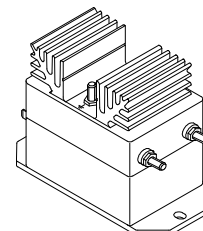

Electrical data

V_{PN}	Primary nominal r.m.s. voltage	1200	V			
V_P	Primary voltage, measuring range	0 .. ± 1800	V			
I_{PN}	Primary nominal r.m.s. current	8.33	mA			
R_M	Measuring resistance	R_{Mmin}	R_{Mmax}			
		with $\pm 15 \text{ V}$	@ $\pm 1200 \text{ V}_{max}$	0	170	Ω
			@ $\pm 1800 \text{ V}_{max}$	0	90	Ω
I_{SN}	Secondary nominal r.m.s. current	50	mA			
K_N	Conversion ratio	1200 V / 50 mA				
V_C	Supply voltage ($\pm 5 \%$)	± 15	V			
I_C	Current consumption	$10 + I_s$	mA			
V_d	R.m.s. voltage for AC isolation test, 50 Hz, 1 mn	6	kV			

Features

- Closed loop (compensated) voltage transducer using the Hall effect
- Insulated plastic case recognized according to UL 94-V0
- Primary resistor R_1 incorporated into the housing.

Advantages

- Excellent accuracy
- Very good linearity
- Low thermal drift
- High immunity to external interference.

Applications

- AC variable speed drives and servo motor drives
- Static converters for DC motor drives
- Uninterruptible Power Supplies (UPS)
- Power supplies for welding applications.

Accuracy - Dynamic performance data

X_G	Overall Accuracy @ $V_{PN}, T_A = 25^\circ\text{C}$	± 0.7	%
e_L	Linearity	< 0.1	%
I_O	Offset current @ $I_P = 0, T_A = 25^\circ\text{C}$	Typ	Max
I_{OT}	Thermal drift of I_O	± 0.2	± 0.3
t_r	Response time @ 90 % of V_{Pmax}	120	μs

General data

T_A	Ambient operating temperature	0 .. +70	$^\circ\text{C}$
T_S	Ambient storage temperature	-25 .. +85	$^\circ\text{C}$
N	Turns ratio	12000 : 2000	
P	Total primary power loss	10	W
R_1	Primary resistance @ $T_A = 25^\circ\text{C}$	144	k Ω
R_S	Secondary coil resistance @ $T_A = 70^\circ\text{C}$	60	Ω
m	Mass	850	g
	Standards ¹⁾	EN 50178	

Note : ¹⁾ A list of corresponding tests is available

Dimensions LV 100-1200 (in mm. 1 mm = 0.0394 inch)

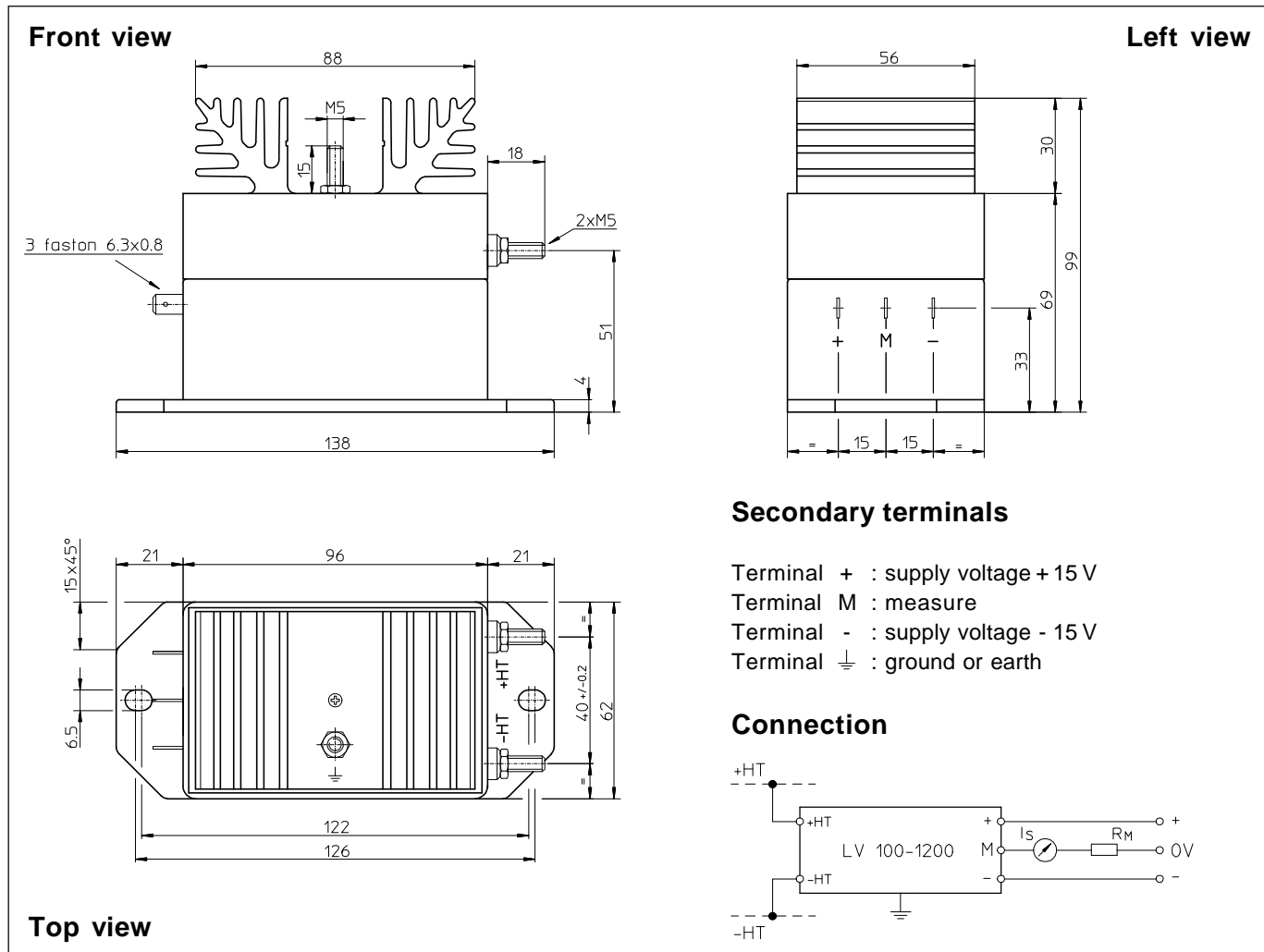

Mechanical characteristics

- General tolerance ± 0.3 mm
- Fastening 2 holes $\varnothing 6.5$ mm
- Connection of primary M5 threaded studs
- Connection of secondary Faston 6.3 x 0.8 mm
- Connection to the ground M5 threaded stud
- Fastening torque 2.2 Nm or 1.62 Lb. -Ft.

Remarks

- I_s is positive when V_p is applied on terminal +HT.
- The primary circuit of the transducer must be linked to the connections where the voltage has to be measured.
- This is a standard model. For different versions (supply voltages, turns ratios, unidirectional measurements...), please contact us.