

**描述 / Descriptions**

TO-277 塑封封装 肖特基二极管。  
TO-277 Plastic package Schottky diode .

**特征 / Features**

高正向浪涌能力，超低正向压降，优异的高温稳定性。  
High Forward Surge Capability, Ultra Low Forward Voltage Drop, Excellent High Temperature Stability.

**用途 / Applications**

用于高频、低压、大电流整流二极管，续流二极管，保护二极管。  
For use in low voltage,high frequency inverters, free wheeling, and polarity protection applications.

**内部等效电路 / Equivalent Circuit**

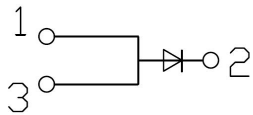

**引脚排列 / Pinning**

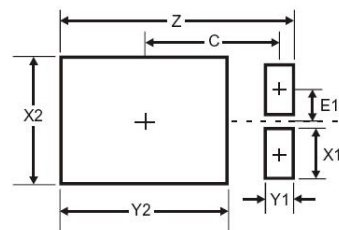

Dimensions	Value (in mm)
Z	6.6
X1	1.4
X2	3.6
Y1	0.8
Y2	4.7
C	3.87
E1	0.9

PIN1 : Anode    PIN 2 : Cathode    PIN 3 : Anode

Suggested Pad layout

**放大及印章代码 / h<sub>FE</sub> Classifications & Marking**

见印章说明。 See Marking Instructions.

**极限参数 / Absolute Maximum Ratings(Ta=25°C)**

参数 Parameter	符号 Symbol	数值 Rating	单位 Unit
Peak Repetitive Reverse Voltage Working Peak Reverse Voltage Peak Reverse Voltage	$V_{RRM}$ $V_{RWM}$ $V_{RM}$	100	V
RMS Reverse voltage	$V_{R(RMS)}$	78	V
Average Rectified Output Current	$I_O$	10	A
Non-Repetitive Peak Forward Surge Current	$I_{FSM}$	150	A
Repetitive peak avalanche power	$P_{ARM}$	20000	W
Junction Temperature Range	$T_{jMAX}$	150	°C
Storage Temperature Range	$T_{stg}$	-55~150	°C
Typical Thermal Resistance	$R_{\theta JA}$ (Note 1)	76	°C/W

**电性能参数 / Electrical Characteristics(Ta=25°C)**

参数 Parameter	符号 Symbol	测试条件 Test Conditions	最小值 Min	典型值 Typ	最大值 Max	单位 Unit
Reverse Voltage	$V_R$	$I_R=0.3mA$	100			V
Forward voltage	$V_F$	$I_F=2A$ $T_J=25^\circ C$		0.43		V
		$I_F=2A$ $T_J=125^\circ C$		0.33		V
		$I_F=10A$ $T_J=25^\circ C$		0.62	0.72	V
		$I_F=10A$ $T_J=125^\circ C$		0.57	0.65	V
Instantaneous Reverse Current	$I_{R(}(\text{Note 2})$	$V_R=100V$ $T_J=25^\circ C$		15	100	uA
		$V_R=100V$ $T_J=125^\circ C$		10	25	mA

注/Notes:

1. FR-4 PCB, 2盎司铜, 最低建议焊盘布局。/FR-4 PCB, 2oz. Copper, minimum recommended pad layout per.
2. 使用极短的测试时间,以尽量减少自热效应。/Short duration pulse test used to minimize self-heating effect.

**电参数曲线图 / Electrical Characteristic Curve**

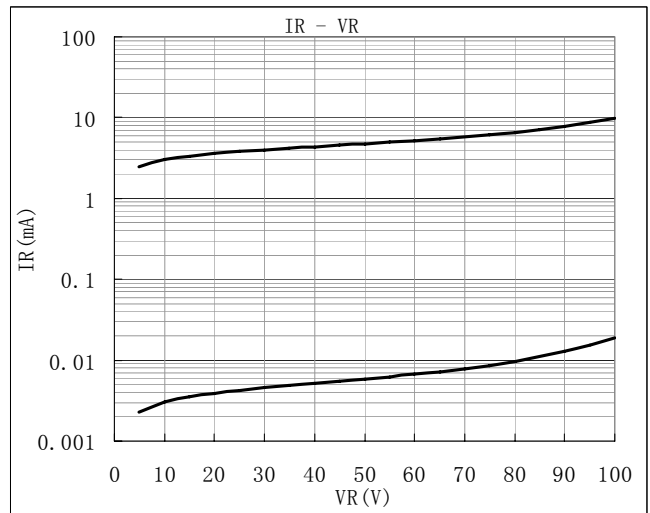
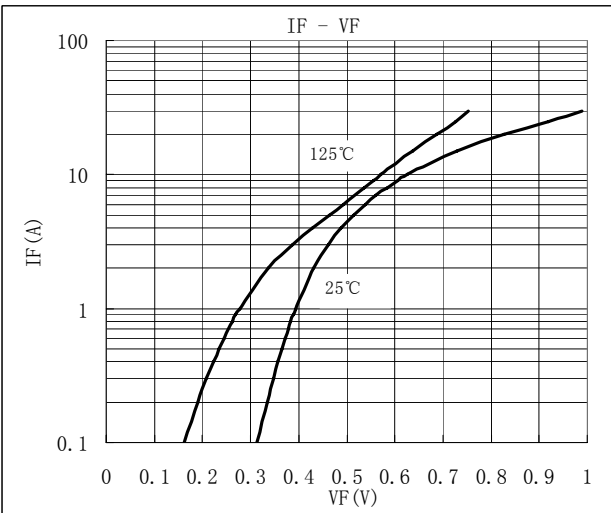
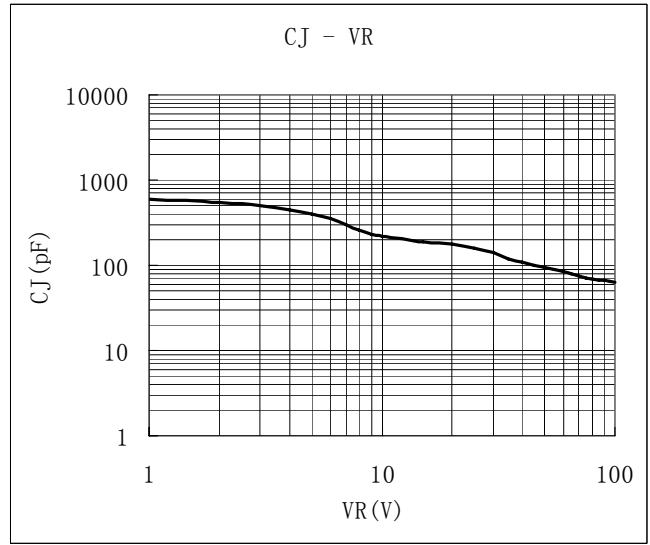
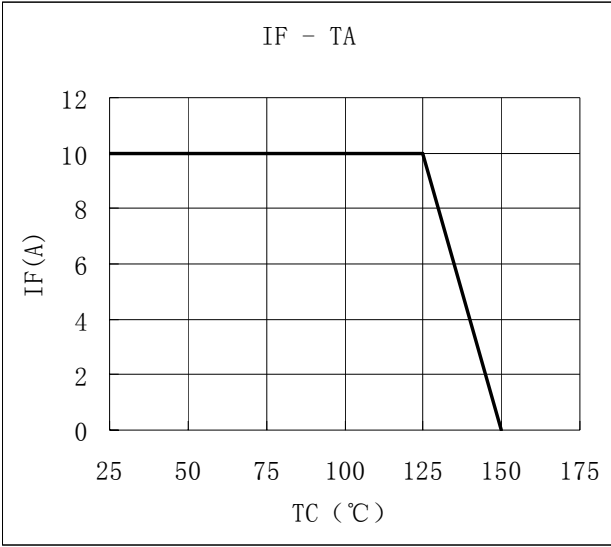

外形尺寸图 / Package Dimensions

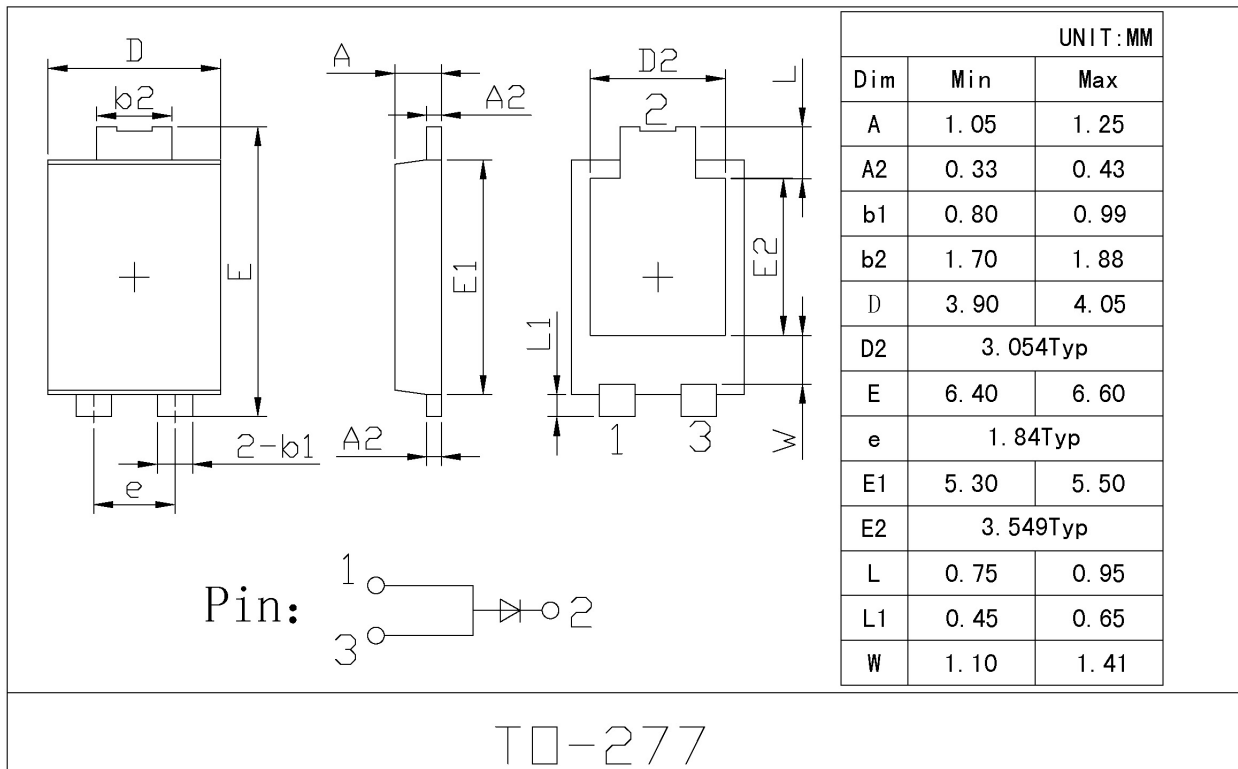

印章说明 / Marking Instructions

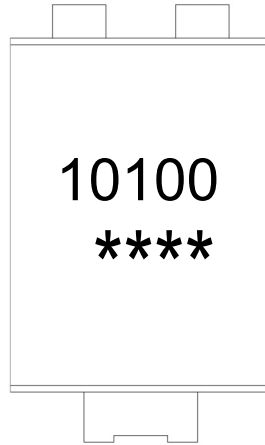

说明：

10100：为型号代码

\*\*\*\*：为生产批号代码，随生产批号变化。

Note:

10100：Product Type.

\*\*\*\*: Lot No. Code, code change with Lot No.

**回流焊温度曲线图(无铅) / Temperature Profile for IR Reflow Soldering(Pb-Free)**

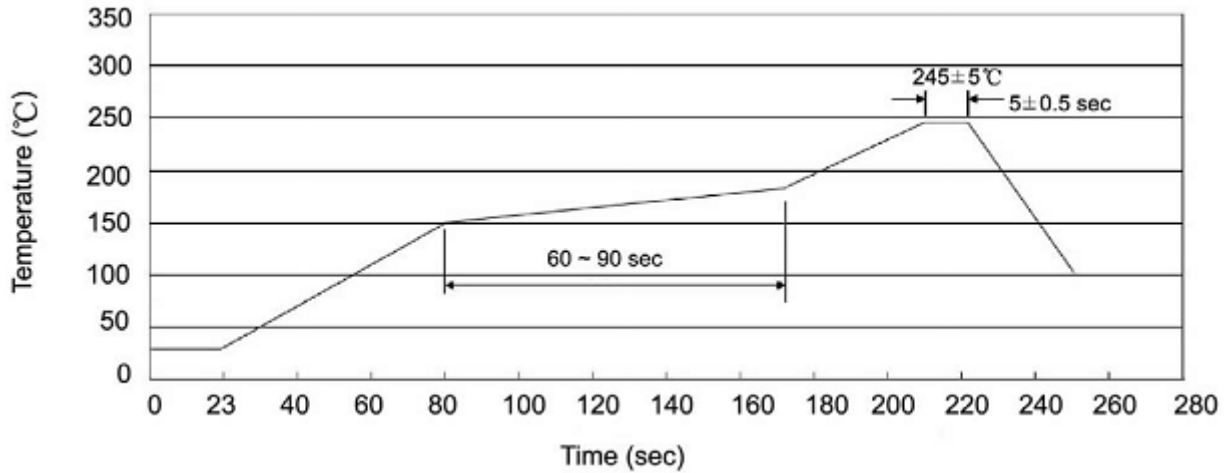

说明：

- 1、预热温度 25~150°C，时间 60~90sec;
- 2、峰值温度 245±5°C，时间持续为 5±0.5sec;
- 3、焊接制程冷却速度为 2~10°C/sec.

Note:

- 1.Preheating:25~150°C, Time:60~90sec.
- 2.Peak Temp.:245±5°C, Duration:5±0.5sec.
3. Cooling Speed: 2~10°C/sec.

**耐焊接热试验条件 / Resistance to Soldering Heat Test Conditions**

温度：260±5°C

时间：10±1 sec.

Temp.:260±5°C

Time:10±1 sec

**包装规格 / Packaging SPEC.**

卷盘包装 / REEL

Package Type 封装形式	Units 包装数量					Dimension 包装尺寸 (unit: mm <sup>3</sup> )		
	Units/Reel 只/卷盘	Reels/Inner Box 卷盘/盒	Units/Inner Box 只/盒	Inner Boxes/Outer Box 盒/箱	Units/Outer Box 只/箱	Reel	Inner Box 盒	Outer Box 箱
TO-277	5,000	3	15,000	5	75,000	13" ×12	360×360×50	385×257×392

**使用说明 / Notices**