

描述 / Descriptions

TO-277 塑封封装 肖特基二极管。
TO-277 Plastic package Schottky diode .

特征 / Features

高正向浪涌能力，超低正向压降，优异的高温稳定性。
High Forward Surge Capability, Ultra Low Forward Voltage Drop, Excellent High Temperature Stability.

用途 / Applications

用于高频、低压、大电流整流二极管，续流二极管，保护二极管。
For use in low voltage,high frequency inverters, free wheeling, and polarity protection applications.

内部等效电路 / Equivalent Circuit

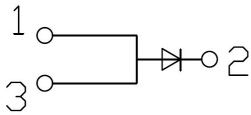

引脚排列 / Pinning

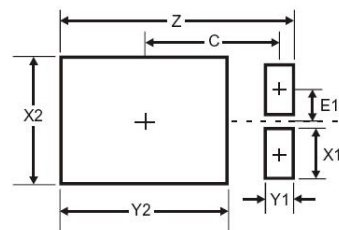

Dimensions	Value (in mm)
Z	6.6
X1	1.4
X2	3.6
Y1	0.8
Y2	4.7
C	3.87
E1	0.9

PIN1 : Anode PIN 2 : Cathode PIN 3 : Anode

Suggested Pad layout

放大及印章代码 / h_{FE} Classifications & Marking

见印章说明。 See Marking Instructions.

极限参数 / Absolute Maximum Ratings(Ta=25°C)

参数 Parameter	符号 Symbol	数值 Rating	单位 Unit
Peak Repetitive Reverse Voltage Working Peak Reverse Voltage Peak Reverse Voltage	V_{RRM} V_{RWM} V_{RM}	45	V
RMS Reverse voltage	$V_{R(RMS)}$	32	V
Average Rectified Output Current	I_O	10	A
Non-Repetitive Peak Forward Surge Current	I_{FSM}	275	A
Repetitive peak avalanche power	P_{ARM}	30000	W
Junction Temperature Range	T_j $V_R \leq 80\% V_{RRM}$	150	°C
Storage Temperature Range	T_{stg}	-55~150	°C
Typical Thermal Resistance	$R_{\theta JA}$ (Note 1)	73	°C/W

电性能参数 / Electrical Characteristics(Ta=25°C)

参数 Parameter	符号 Symbol	测试条件 Test Conditions	最小值 Min	典型值 Typ	最大值 Max	单位 Unit
Reverse Voltage	V_R	$I_R=0.3mA$	45			V
Forward voltage	V_F	$I_F=8A$ $T_J=25^\circ C$		0.36	0.39	V
		$I_F=10A$ $T_J=25^\circ C$		0.38	0.41	V
		$I_F=10A$ $T_J=125^\circ C$		0.31	0.33	V
Instantaneous Reverse Current	I_R (Note 2)	$V_R=45V$ $T_J=25^\circ C$			0.3	mA
		$V_R=45V$ $T_J=100^\circ C$			30	mA
		$V_R=45V$ $T_J=125^\circ C$			150	mA

注/Notes:

- FR-4 PCB, 2盎司铜, 最低建议焊盘布局。/FR-4 PCB, 2oz. Copper, minimum recommended pad layout per.
- 使用极短的测试时间,以尽量减少自热效应。/Short duration pulse test used to minimize self-heating effect.

电参数曲线图 / Electrical Characteristic Curve

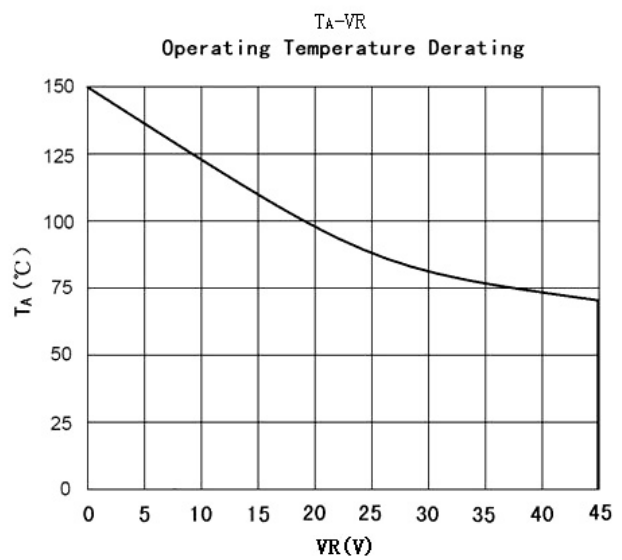
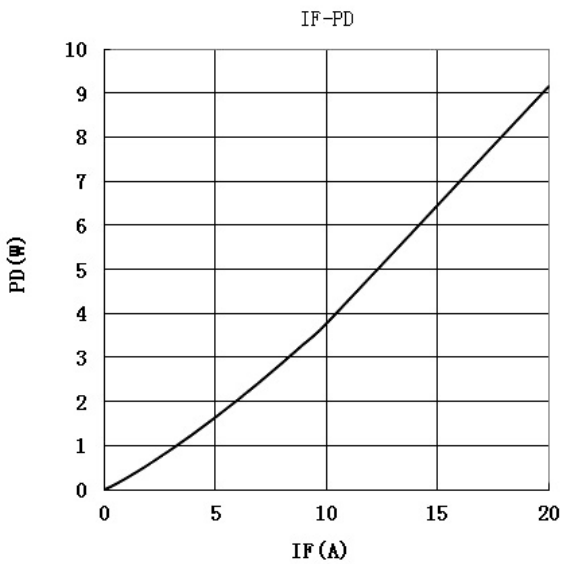
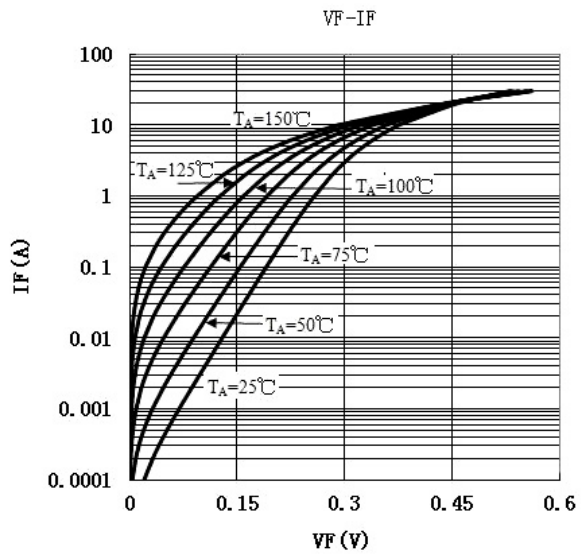
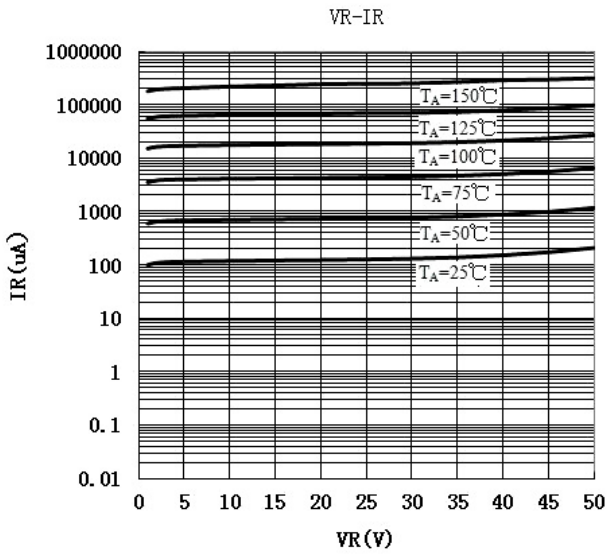

外形尺寸图 / Package Dimensions

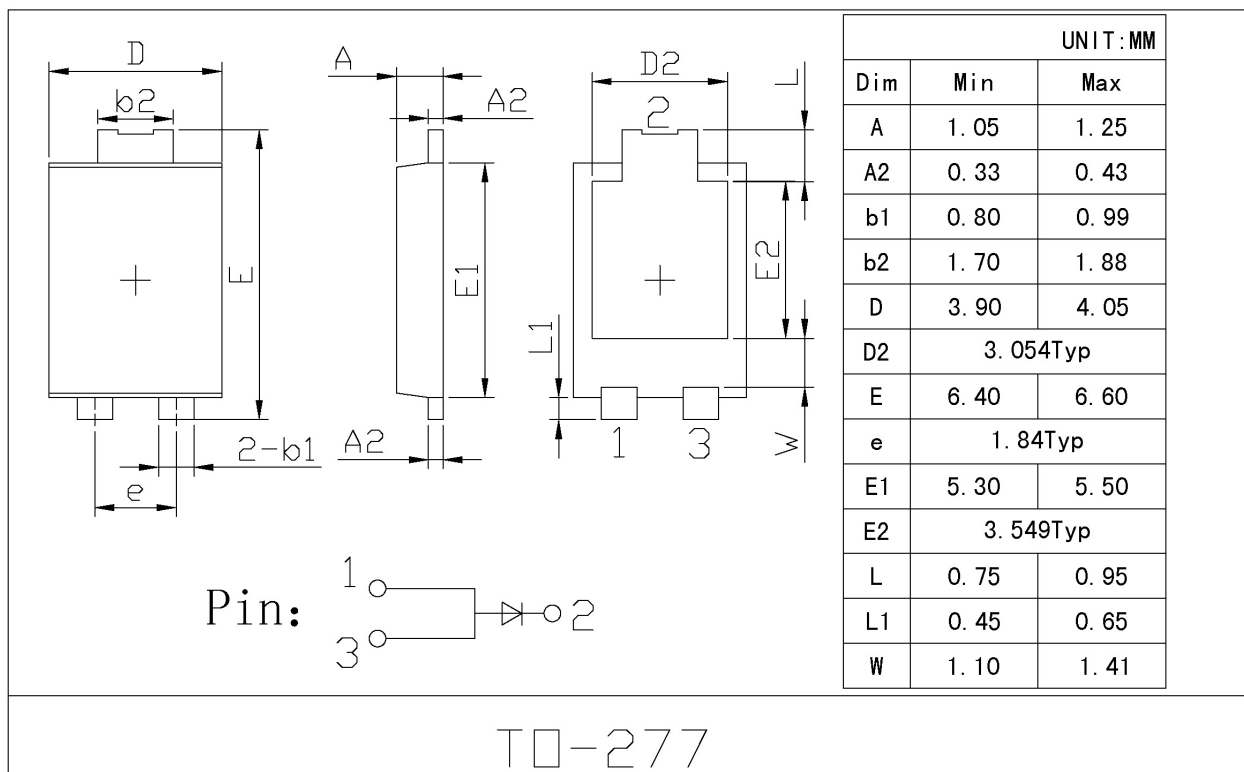

印章说明 / Marking Instructions

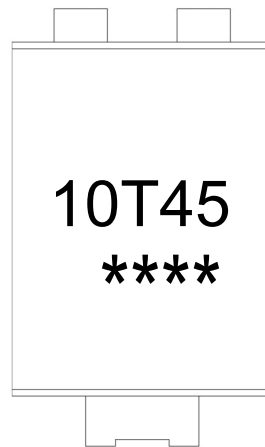

说明：

10T45： 为型号代码

****： 为生产批号代码，随生产批号变化

Note:

10T45： Product Type.

****: Lot No. Code, code change with Lot No.

回流焊温度曲线图(无铅) / Temperature Profile for IR Reflow Soldering(Pb-Free)



说明：

- 1、预热温度 25~150°C，时间 60~90sec；
- 2、峰值温度 245±5°C，时间持续为 5±0.5sec；
- 3、焊接制程冷却速度为 2~10°C/sec.

Note:

- 1.Preheating:25~150°C, Time:60~90sec.
- 2.Peak Temp.:245±5°C, Duration:5±0.5sec.
3. Cooling Speed: 2~10°C/sec.

耐焊接热试验条件 / Resistance to Soldering Heat Test Conditions

温度：260±5°C

时间：10±1 sec.

Temp.:260±5°C

Time:10±1 sec

包装规格 / Packaging SPEC.

卷盘包装 / REEL

Package Type 封装形式	Units 包装数量					Dimension 包装尺寸 (unit: mm ³)		
	Units/Reel 只/卷盘	Reels/Inner Box 卷盘/盒	Units/Inner Box 只/盒	Inner Boxes/Outer Box 盒/箱	Units/Outer Box 只/箱	Reel	Inner Box 盒	Outer Box 箱
TO-277	5,000	3	15,000	5	75,000	13" ×12	360×360×50	385×257×392

使用说明 / Notices