

LV3311PNM

Electronic Volume IC for Car Audio System



ON Semiconductor®

www.onsemi.com

Overview

The LV3311PNM is an electronic volume IC implements a rich set of audio control functions with a minimal number of external components. Functions include input selection switching function, an input gain, volume, loudness, balance, fader, bass/mid/treble and subwoofer control.

Features

- It is possible to eliminate from the external components of equalizer control block by SCF technology.
- Zero-cross switching circuits (Volume control block and Fader control block), soft step (3 band equalizer control and Subwoofer control) and soft mute circuits used for low noise even when input signals are present.
- Low power consumption due to the use of BiCMOS process.
- All functions are controlled using serial data (CCB*).

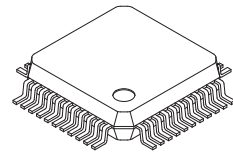

PQFP44 10x10 / QIP44M

Features

- Input selector :
Four of the input systems are single-end inputs, one uses differential inputs.
- Input gain control :
The input single can be amplified by 0 to +18 dB (1 dB steps.)
- Loudness control :
Taps are output starting at the -32 dB position of the ladder resistor and a loudness function implemented with external capacitor and resistor components.
- Volume control : +10 dB to -79 dB / -∞ (1 dB steps)
L/R independent control.
- Bass control :
The bass control gain can be maximum boost +12 dB position and maximum cut -12 dB position.
(+12 dB to -12 dB in 2 dB steps.)
The bass control center frequency 70 Hz / 100 Hz / 120 Hz can be selected.
The bass control quality factor 1.0/2.0 can be selected.

Continued on next page.

* Computer Control Bus (CCB) is an ON Semiconductor's original bus format and the bus addresses are controlled by ON Semiconductor.

ORDERING INFORMATION

See detailed ordering and shipping information on page 21 of this data sheet.

LV3311PNM

Continued from preceding page.

- **Middle control :**
 The middle control gain can be maximum boost +12 dB position and maximum cut –12 dB position.
 (+12 dB to –12 dB in 2 dB steps.)
 The middle control center frequency 700 Hz / 1 kHz / 1.2 kHz can be selected.
 The middle control quality factor 1.0/2.0 can be selected.
- **Treble control :**
 The treble control gain can be maximum boost +12 dB position and maximum cut –12 dB position.
 (+12 dB to –12 dB in 2 dB steps.)
 The treble control center frequency 7 kHz / 10 kHz / 12 kHz can be selected.
 The treble control quality factor 1.0/2.0 can be selected.
- **Fader control :**
 The fader volume can be attenuations by one of 16 levels. Independent control each four channels.
 (A total of 16 settings with attenuations of 0 to –2 dB in 1dB steps, –2 to –20 dB in 2 dB steps, and
 –30, –45, –60, and –∞ dB settings.)
- **Subwoofer control :**
 A total of 81 positions from 0 to –79 dB in 1 dB steps and –∞ dB.
 The low pass filter 80 Hz / 120 Hz / 160 Hz can be selected. Fedar two channels output only of rear or either of the
 subwoofer output is selected.
- **Mute**

Specifications

Absolute Maximum Ratings at Ta = 25°C, VSS = 0 V

Parameter	Symbol	Conditions	Ratings	Unit
Maximum supply voltage	VDD max	VDD	9.5	V
Maximum input voltage	VIN max	All input pins	VSS–0.3 to VDD	V
Allowable power dissipation	Pd max	Ta ≤ 85°C, when mounted on a printed circuit board *	600	mW
Operating temperature	Topr		–40 to +85	°C
Storage temperature	Tstg		–50 to +125	°C

* Specified circuit board : 114.3 × 76.1 × 1.6 mm³ : glass epoxy board

Stresses exceeding those listed in the Maximum Ratings table may damage the device. If any of these limits are exceeded, device functionality should not be assumed, damage may occur and reliability may be affected.

Allowable Operating Ratings at Ta = 25°C, VSS = 0 V

Parameter	Symbol	Conditions	Ratings			Unit
			min	typ	max	
Supply voltage	VDD	VDD	7.0	8.0	9.0	V
High-level input voltage	VIH	CL, DI, CE	4.5		5.5	V
Low-level input voltage	VIL	CL, DI, CE	VSS		1.0	V
Input voltage amplitude	VIN		VSS		VDD	Vp-p
Input pulse width	TφW	CL	1			μs
Setup time	Tsetup	CL, DI, CE	1			μs
Hold time	Thold	CL, DI, CE	1			μs
Operating frequency	fopg	CL			500	kHz

Functional operation above the stresses listed in the Recommended Operating Ranges is not implied. Extended exposure to stresses beyond the Recommended Operating Ranges limits may affect device reliability.

LV3311PNM

Electrical Characteristics at Ta = 25°C, V_{DD} = 8 V, V_{SS} = 0 V

Parameter	Symbol	Conditions	Ratings			Unit
			min	typ	max	
Input block						
Input resistance	R _{in}	L1-L4, R1-R4		50		kΩ
Minimum input gain	G _{in min}	L1-L4, R1-R4	-1.0	0	+1.0	dB
Maximum input gain	G _{i max}		+17	+18	+19	dB
Inter-step setting error	A _{Terr}		-1.0		+1.0	dB
Left/Right balance	BAL		-0.5		+0.5	dB
Volume block						
Input resistance	R _{vr}	LVRIN, RVRIN		50		kΩ
Inter-step setting error	A _{Terr}	+10 dB to -40 dB	-0.5		+0.5	dB
Left/Right balance	BAL		-0.5		+0.5	dB
Bass block						
Bass control range	G _{b max}	max. boost/cut	±10	±12	±14	dB
Inter-step setting error	A _{Terr}	-10 dB to +10 dB	-1.0		+1.0	dB
Left/Right balance	BAL		-1.0		+1.0	dB
Center frequency	f ₀₁	GAIN = ±12 dB		70		Hz
	f ₀₂			100		Hz
	f ₀₃			120		Hz
Quality Factor	Q ₀₁	GAIN = ±12 dB		1.0		
	Q ₀₂			2.0		
Mid block						
Mid control range	G _{b max}	max. boost/cut	±10	±12	±14	dB
Inter-step setting error	A _{Terr}	-10 dB to +10 dB	-1.0		+1.0	dB
Left/Right balance	BAL		-1.0		+1.0	dB
Center frequency	f ₀₁	GAIN = ±12 dB		700		Hz
	f ₀₂			1		kHz
	f ₀₃			1.2		kHz
Quality Factor	Q ₀₁	GAIN = ±12 dB		1.0		
	Q ₀₂			2.0		
Treble block						
Treble control range	G _{b max}	max. boost/cut	±10	±12	±14	dB
Inter-step setting error	A _{Terr}	-10 dB to +10 dB	-1.0		+1.0	dB
Left/Right balance	BAL		-1.0		+1.0	dB
Center frequency	f ₀₁	GAIN = ±12 dB		7		kHz
	f ₀₂			10		kHz
	f ₀₃			12		kHz
Quality Factor	Q ₀₁	GAIN = ±12 dB		1.0		
	Q ₀₂			2.0		
Subwoofer block						
Sub volume inter-step setting error	A _{Terr}	0dB to -40 dB	-0.5		+0.5	dB
LPF center frequency	f ₀			80		Hz
	f ₁			120		Hz
	f ₂			160		Hz
Fader block						
Input resistance	R _{fed}			50		kΩ
Inter-step setting error	A _{Terr}	0 dB to -2 dB	-0.5		+0.5	dB
		-4 dB to -20 dB	-1.0		+1.0	dB
		-30 dB	-2.0		+2.0	dB
		-45 dB	-3.0		+3.0	dB
Left/Right balance	BAL	0 dB to -30 dB	-0.5		+0.5	dB

Product parametric performance is indicated in the Electrical Characteristics for the listed test conditions, unless otherwise noted. Product performance may not be indicated by the Electrical Characteristics if operated under different conditions.

LV3311PNM

Overall Characteristics at $T_a = 25^\circ\text{C}$, $V_{DD} = 8\text{ V}$, $V_{SS} = 0\text{ V}$

Parameter	Symbol	Conditions	Ratings			Unit
			min	typ	max	
A loss of insertion	ATT		-1.0		+1.0	dB
Total harmonic distortion	THD	$V_{IN} = 1\text{ V}_{rms}$, $f = 1\text{ kHz}$		0.01		%
Inter-input crosstalk	CT	$V_{IN} = 1\text{ V}_{rms}$, $f = 1\text{ kHz}$		80		dB
Left/Right channel crosstalk	CT	$V_{IN} = 1\text{ V}_{rms}$, $f = 1\text{ kHz}$		80		dB
Maximum attenuation	$V_O\text{ min}$	$V_{IN} = 1\text{ V}_{rms}$, $f = 1\text{ kHz}$		80		dB
Output noise voltage	VN			25		μV
Current drain	I_{DD}			20		mA
Input high-level current	I_{IH}	CL, DI, CE, $V_{IN} = 5.5\text{ V}$			10	μA
Input low-level current	I_{IL}	CL, DI, CE, $V_{IN} = 0\text{ V}$	-10			μA
Maximum input voltage	VCL	THD = 1% $R_L = 10\text{ k}\Omega$ all controls flat, $f_{IN} = 1\text{ kHz}$		2.2		V_{rms}
Common-mode rejection ratio	CMRR	$V_{IN} = 0\text{ dBV}$, $f = 1\text{ kHz}$		50		dB

LV3311PNM

Package Dimensions

unit : mm

PQFP44 10x10 / QIP44M
CASE 122BK
ISSUE A

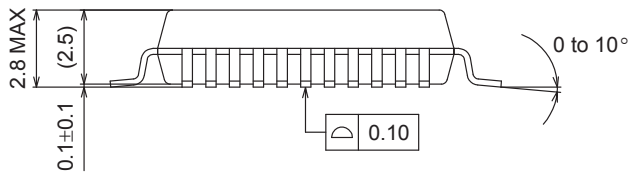
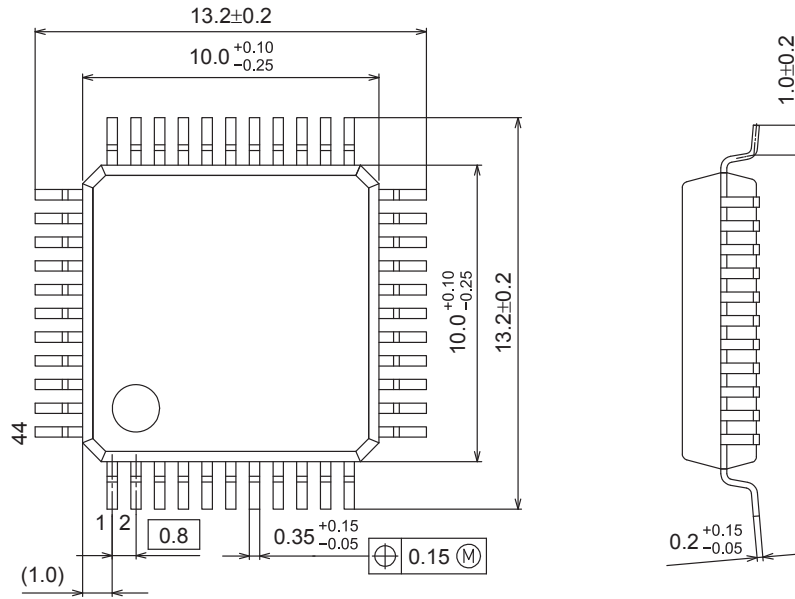

SOLDERING FOOTPRINT*

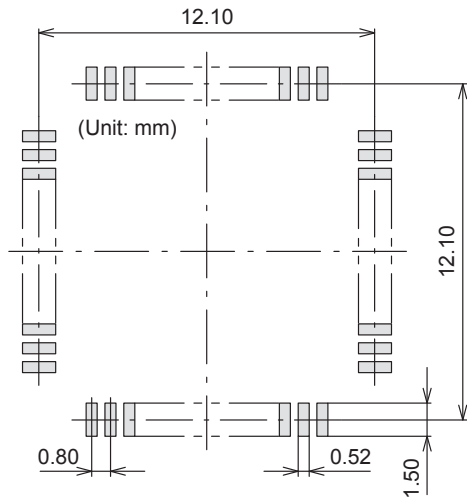

GENERIC MARKING DIAGRAM*

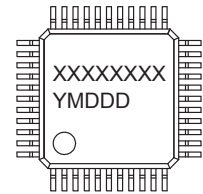
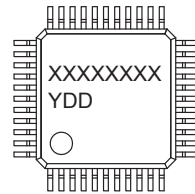

XXXXXX = Specific Device Code
Y = Year
DD = Additional Traceability Data

XXXXXX = Specific Device Code
Y = Year
M = Month
DDD = Additional Traceability Data

*This information is generic. Please refer to device data sheet for actual part marking. Pb-Free indicator, "G" or microdot "▪", may or may not be present.

NOTE: The measurements are not to guarantee but for reference only.

*For additional information on our Pb-Free strategy and soldering details, please download the ON Semiconductor Soldering and Mounting Techniques Reference Manual, SOLDERRM/D.

LV3311PNM

Pin Assignment

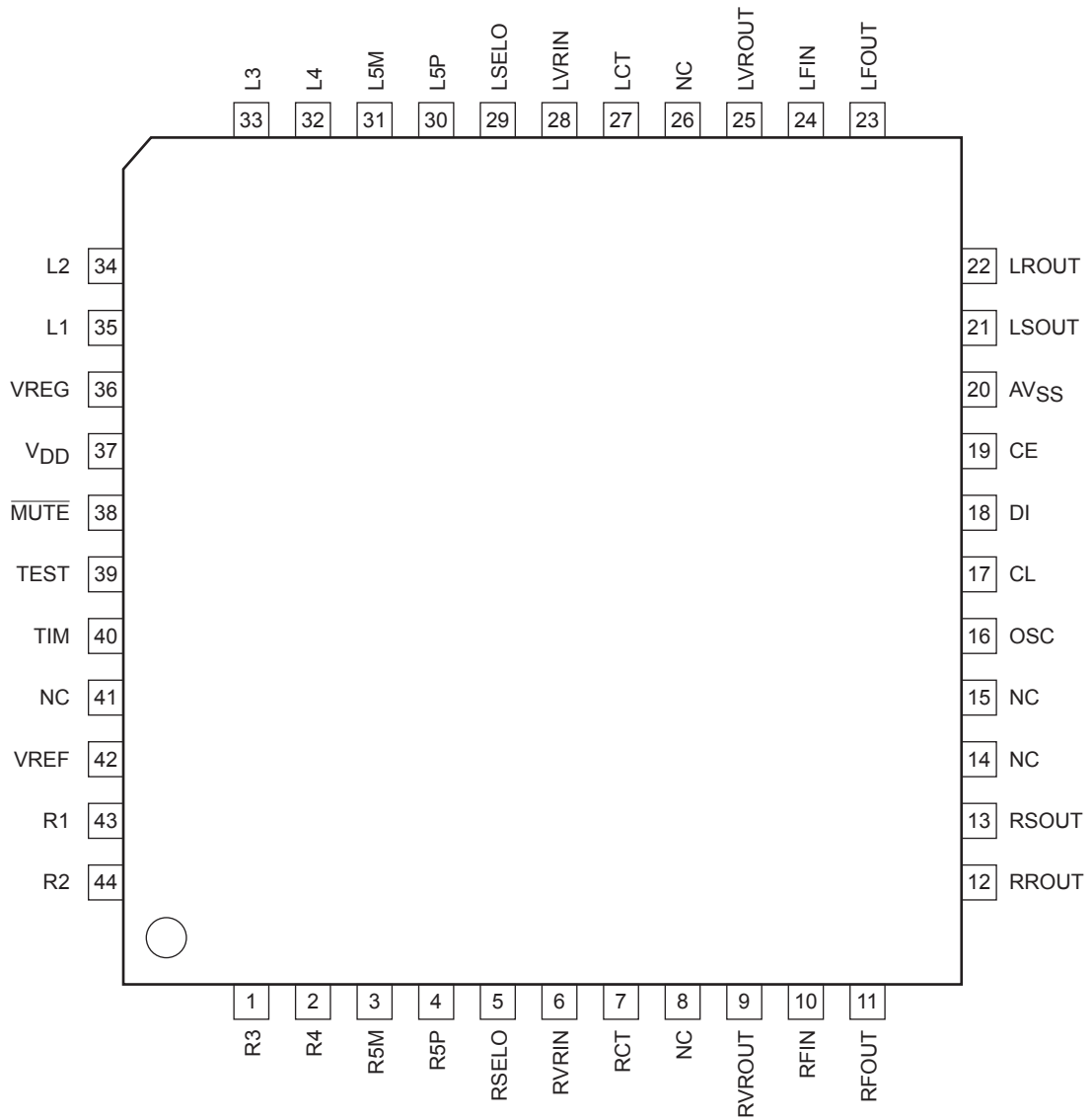

LV3311PNM

Block Diagram

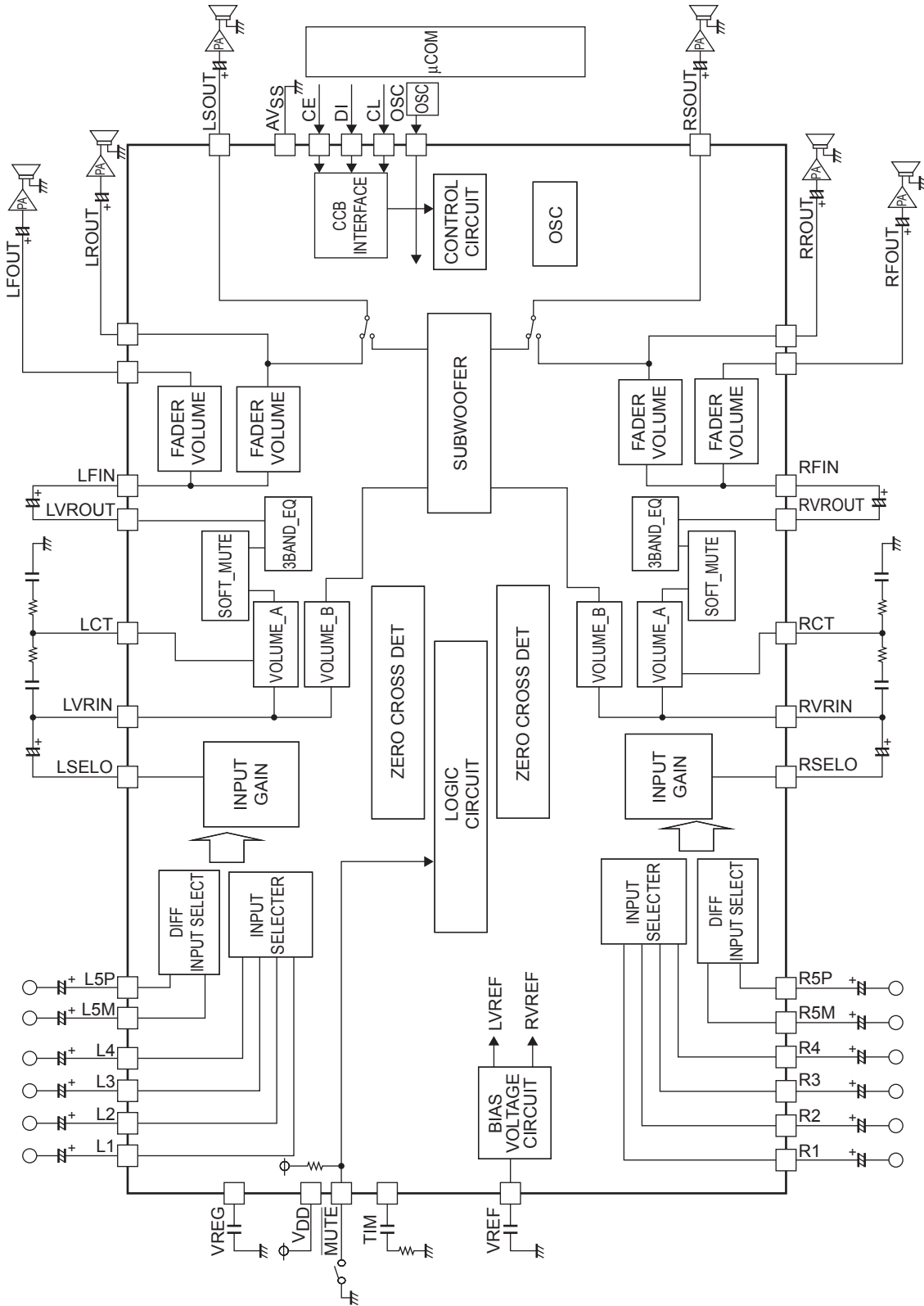

* Note that VOLUME_A/B control data are interlocked with each other.

LV3311PNM

Pin Functions

Pin No.	Pin	Function	Equivalent Circuit
35 34 33 32 43 44 1 2	L1 L2 L3 L4 R1 R2 R3 R4	Single end input pins.	
31 30 3 4	L5M L5P R5M R5P	Differential input pins.	
29 5	LSELO RSELO	Input selector output pins.	
28 6	LVRIN RVRIN	Main volume input pins.	
27 7	LCT RCT	Loudness function pins.	
25 9	LVROUT RVROUT	Tone output pins.	
24 10	LFIN RFIN	Fader block input pins. Drive at low impedance.	
23 22 11 12	LFOUT LROUT RFOUT RROUT	Fader output pins. Attenuation is possible separately for the front end and rear end.	

Continued on next page.

LV3311PNM

Continued from preceding page.

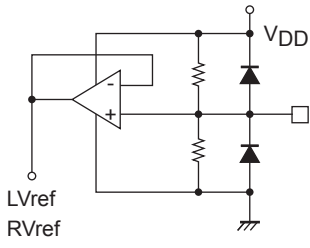
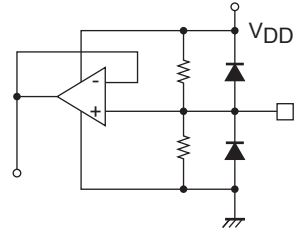
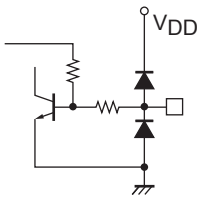
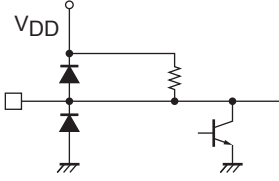
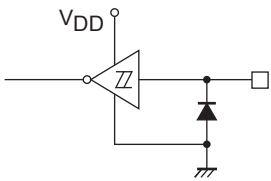
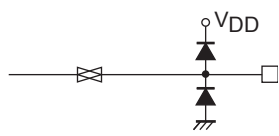
Pin No.	Pin	Function	Equivalent Circuit
42	Vref	Connect a capacitor of a few tens of uF between Vref and AVSS (VSS) as a 0.55 × VDD voltage generator, current ripple countermeasure.	
36	VREG	Internal logic voltage pin.	
37	VDD	Power supply pin.	
20	AVSS	Ground pin.	
38	MUTE	External muting control pin. Setting this pin to VSS level sets forcibly fader volume block to -∞ level.	
40	TIM	Timer pin when there is no signal in the zero cross circuit. Forcibly set data when there is no zero cross signal, from the time the data is set until the timer ends.	
17	CL	Input pin for serial data and clock used for control. Chip enable pin. Data is written to the internal latch and the analog switches are operated when the level changes from High to Low. Data transfer is enabled when the level is High.	
18	DI		
19	CE		
39	TEST	Normally this pin is OPEN.	
21	LSOUT	Subwoofer output pin.	
13	RSOUT		
16	OSC	External oscillat input pin.	
14	NC	no connect pin (Normally these pins are OPEN.)	
15			
26			
8			
41			

LV3311PNM

Control System Timing and Data Format

The LV3311PNM is controlled by applying the stipulated data to the CL, DI and CE pins. The data consists of a total of 144 bits, of which 8 bits are the device address, 136 bits are the control data.

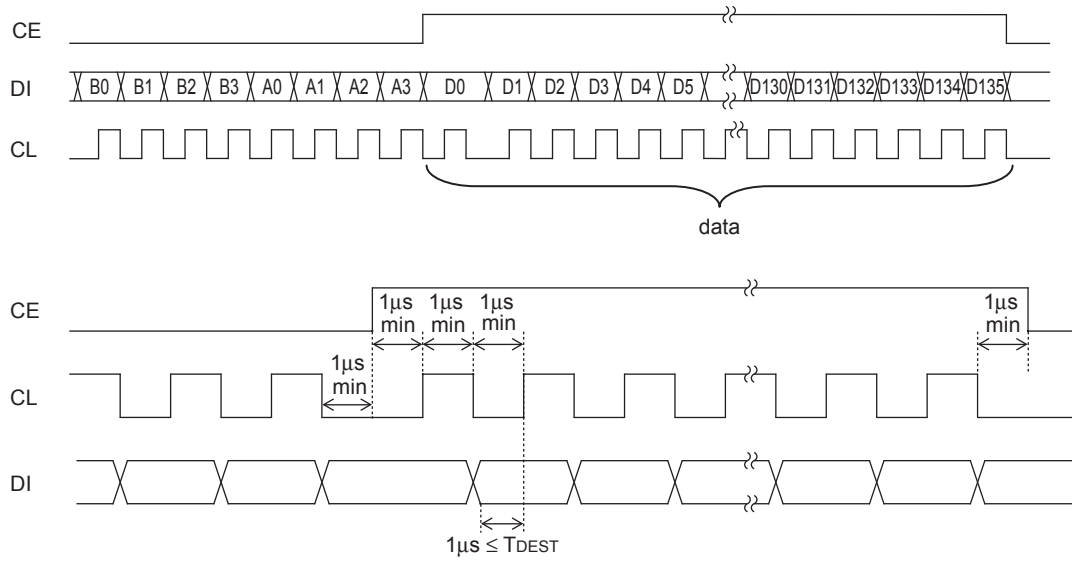

Send to data

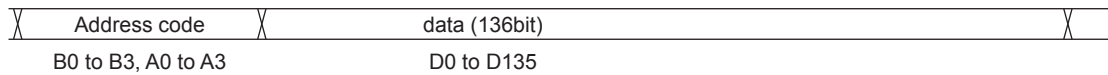

Address code

B0	B1	B2	B3	A0	A1	A2	A3
1	0	0	0	0	0	0	1

Data setting

Input switching control

D0	D1	D2	Operation
0	0	0	INIT
1	0	0	L1 (R1)
0	1	0	L2 (R2)
1	1	0	L3 (R3)
0	0	1	L4 (R4)
1	0	1	L5 (R5)

LV3311PNM

Input gain control

D3	D4	D5	D6	D7	Lch
D8	D9	D10	D11	D12	Rch
0	0	0	0	0	0dB
1	0	0	0	0	+1dB
0	1	0	0	0	+2dB
1	1	0	0	0	+3dB
0	0	1	0	0	+4dB
1	0	1	0	0	+5dB
0	1	1	0	0	+6dB
1	1	1	0	0	+7dB
0	0	0	1	0	+8dB
1	0	0	1	0	+9dB
0	1	0	1	0	+10dB
1	1	0	1	0	+11dB
0	0	1	1	0	+12dB
1	0	1	1	0	+13dB
0	1	1	1	0	+14dB
1	1	1	1	0	+15dB
0	0	0	0	1	+16dB
1	0	0	0	1	+17dB
0	1	0	0	1	+18dB

LV3311PNM

Volume control (10dB to -43dB)

D13	D14	D15	D16	D17	D18	D19	D20	Lch
D21	D22	D23	D24	D25	D26	D27	D28	Rch
0	1	1	0	1	1	1	0	10dB
1	1	1	0	1	1	1	0	9dB
0	0	0	1	1	1	1	0	8dB
1	0	0	1	1	1	1	0	7dB
0	1	0	1	1	1	1	0	6dB
1	1	0	1	1	1	1	0	5dB
0	0	1	1	1	1	1	0	4dB
1	0	1	1	1	1	1	0	3dB
0	1	1	1	1	1	1	0	2dB
1	1	1	1	1	1	1	0	1dB
0	0	0	0	0	0	0	0	0dB
1	0	0	0	0	0	0	0	-1dB
0	1	0	0	0	0	0	0	-2dB
1	1	0	0	0	0	0	0	-3dB
0	0	1	0	0	0	0	0	-4dB
1	0	1	0	0	0	0	0	-5dB
0	1	1	0	0	0	0	0	-6dB
1	1	1	0	0	0	0	0	-7dB
0	0	0	1	0	0	0	0	-8dB
1	0	0	1	0	0	0	0	-9dB
0	1	0	1	0	0	0	0	-10dB
1	1	0	1	0	0	0	0	-11dB
0	0	1	1	0	0	0	0	-12dB
1	0	1	1	0	0	0	0	-13dB
0	1	1	1	0	0	0	0	-14dB
1	1	1	1	0	0	0	0	-15dB
0	0	0	0	1	0	0	0	-16dB
1	0	0	0	1	0	0	0	-17dB
0	1	0	0	1	0	0	0	-18dB
1	1	0	0	1	0	0	0	-19dB
0	0	1	0	1	0	0	0	-20dB
1	0	1	0	1	0	0	0	-21dB
0	1	1	0	1	0	0	0	-22dB
1	1	1	0	1	0	0	0	-23dB
0	0	0	1	1	0	0	0	-24dB
1	0	0	1	1	0	0	0	-25dB
0	1	0	1	1	0	0	0	-26dB
1	1	0	1	1	0	0	0	-27dB
0	0	1	1	1	0	0	0	-28dB
1	0	1	1	1	0	0	0	-29dB
0	1	1	1	1	0	0	0	-30dB
1	1	1	1	1	0	0	0	-31dB
0	0	0	0	0	1	0	0	-32dB
1	0	0	0	0	1	0	0	-33dB
0	1	0	0	0	1	0	0	-34dB
1	1	0	0	0	1	0	0	-35dB
0	0	1	0	0	1	0	0	-36dB
1	0	1	0	0	1	0	0	-37dB
0	1	1	0	0	1	0	0	-38dB
1	1	1	0	0	1	0	0	-39dB
0	0	0	1	0	1	0	0	-40dB
1	0	0	1	0	1	0	0	-41dB
0	1	0	1	0	1	0	0	-42dB
1	1	0	1	0	1	0	0	-43dB

LV3311PNM

Volume control (-44dB to -∞)

D13	D14	D15	D16	D17	D18	D19	D20	Lch
D21	D22	D23	D24	D25	D26	D27	D28	Rch
0	0	1	1	0	1	0	0	-44dB
1	0	1	1	0	1	0	0	-45dB
0	1	1	1	0	1	0	0	-46dB
1	1	1	1	0	1	0	0	-47dB
0	0	0	0	1	1	0	0	-48dB
1	0	0	0	1	1	0	0	-49dB
0	1	0	0	1	1	0	0	-50dB
1	1	0	0	1	1	0	0	-51dB
0	0	1	0	1	1	0	0	-52dB
1	0	1	0	1	1	0	0	-53dB
0	1	1	0	1	1	0	0	-54dB
1	1	1	0	1	1	0	0	-55dB
0	0	0	1	1	1	0	0	-56dB
1	0	0	1	1	1	0	0	-57dB
0	1	0	1	1	1	0	0	-58dB
1	1	0	1	1	1	0	0	-59dB
0	0	1	1	1	1	0	0	-60dB
1	0	1	1	1	1	0	0	-61dB
0	1	1	1	1	1	0	0	-62dB
1	1	1	1	1	1	0	0	-63dB
0	0	0	0	0	0	1	0	-64dB
1	0	0	0	0	0	1	0	-65dB
0	1	0	0	0	0	1	0	-66dB
1	1	0	0	0	0	1	0	-67dB
0	0	1	0	0	0	1	0	-68dB
1	0	1	0	0	0	1	0	-69dB
0	1	1	0	0	0	1	0	-70dB
1	1	1	0	0	0	1	0	-71dB
0	0	0	1	0	0	1	0	-72dB
1	0	0	1	0	0	1	0	-73dB
0	1	0	1	0	0	1	0	-74dB
1	1	0	1	0	0	1	0	-75dB
0	0	1	1	0	0	1	0	-76dB
1	0	1	1	0	0	1	0	-77dB
0	1	1	1	0	0	1	0	-78dB
1	1	1	1	0	0	1	0	-79dB
0	0	0	0	1	0	1	0	-∞

LV3311PNM

Tone block

Bass

GAIN	D29	D30	D31	D32	Lch
	D37	D38	D39	D40	Rch
	0	1	1	1	+12dB
	1	0	1	1	+10dB
	0	0	1	1	+8dB
	1	1	0	1	+6dB
	0	1	0	1	+4dB
	1	0	0	1	+2dB
	0	0	0	0	0dB
	1	0	0	0	-2dB
	0	1	0	0	-4dB
	1	1	0	0	-6dB
	0	0	1	0	-8dB
	1	0	1	0	-10dB
	0	1	1	0	-12dB

f0	D33	D34	Lch
	D41	D42	Rch
	0	0	70Hz
	1	0	100Hz
	0	1	120Hz

Q	D35	D36	Lch
	D43	D44	Rch
	0	0	1.00
	1	0	2.00

Mid

GAIN	D45	D46	D47	D48	Lch
	D53	D54	D55	D56	Rch
	0	1	1	1	+12dB
	1	0	1	1	+10dB
	0	0	1	1	+8dB
	1	1	0	1	+6dB
	0	1	0	1	+4dB
	1	0	0	1	+2dB
	0	0	0	0	0dB
	1	0	0	0	-2dB
	0	1	0	0	-4dB
	1	1	0	0	-6dB
	0	0	1	0	-8dB
	1	0	1	0	-10dB
	0	1	1	0	-12dB

f0	D49	D50	Lch
	D57	D58	Rch
	0	0	700Hz
	1	0	1kHz
	0	1	1.2kHz

Q	D51	D52	Lch
	D59	D60	Rch
	0	0	1.00
	1	0	2.00

Treble

GAIN	D61	D62	D63	D64	Lch
	D69	D70	D71	D72	Rch
	0	1	1	1	+12dB
	1	0	1	1	+10dB
	0	0	1	1	+8dB
	1	1	0	1	+6dB
	0	1	0	1	+4dB
	1	0	0	1	+2dB
	0	0	0	0	0dB
	1	0	0	0	-2dB
	0	1	0	0	-4dB
	1	1	0	0	-6dB
	0	0	1	0	-8dB
	1	0	1	0	-10dB
	0	1	1	0	-12dB

f0	D65	D66	Lch
	D73	D74	Rch
	0	0	7kHz
	1	0	10kHz
	0	1	12kHz

Q	D67	D68	Lch
	D75	D76	Rch
	0	0	1.00
	1	0	2.00

LV3311PNM

Sub volume control (0dB to -54dB)

D77	D78	D79	D80	D81	D82	D83	D84	Operation
0	0	0	0	0	0	0	0	0dB
1	0	0	0	0	0	0	0	-1dB
0	1	0	0	0	0	0	0	-2dB
1	1	0	0	0	0	0	0	-3dB
0	0	1	0	0	0	0	0	-4dB
1	0	1	0	0	0	0	0	-5dB
0	1	1	0	0	0	0	0	-6dB
1	1	1	0	0	0	0	0	-7dB
0	0	0	1	0	0	0	0	-8dB
1	0	0	1	0	0	0	0	-9dB
0	1	0	1	0	0	0	0	-10dB
1	1	0	1	0	0	0	0	-11dB
0	0	1	1	0	0	0	0	-12dB
1	0	1	1	0	0	0	0	-13dB
0	1	1	1	0	0	0	0	-14dB
1	1	1	1	0	0	0	0	-15dB
0	0	0	0	1	0	0	0	-16dB
1	0	0	0	1	0	0	0	-17dB
0	1	0	0	1	0	0	0	-18dB
1	1	0	0	1	0	0	0	-19dB
0	0	1	0	1	0	0	0	-20dB
1	0	1	0	1	0	0	0	-21dB
0	1	1	0	1	0	0	0	-22dB
1	1	1	0	1	0	0	0	-23dB
0	0	0	1	1	0	0	0	-24dB
1	0	0	1	1	0	0	0	-25dB
0	1	0	1	1	0	0	0	-26dB
1	1	0	1	1	0	0	0	-27dB
0	0	1	1	1	0	0	0	-28dB
1	0	1	1	1	0	0	0	-29dB
0	1	1	1	1	0	0	0	-30dB
1	1	1	1	1	0	0	0	-31dB
0	0	0	0	0	1	0	0	-32dB
1	0	0	0	0	1	0	0	-33dB
0	1	0	0	0	1	0	0	-34dB
1	1	0	0	0	1	0	0	-35dB
0	0	1	0	0	1	0	0	-36dB
1	0	1	0	0	1	0	0	-37dB
0	1	1	0	0	1	0	0	-38dB
1	1	1	0	0	1	0	0	-39dB
0	0	0	1	0	1	0	0	-40dB
1	0	0	1	0	1	0	0	-41dB
0	1	0	1	0	1	0	0	-42dB
1	1	0	1	0	1	0	0	-43dB
0	0	1	1	0	1	0	0	-44dB
1	0	1	1	0	1	0	0	-45dB
0	1	1	1	0	1	0	0	-46dB
1	1	1	1	0	1	0	0	-47dB
0	0	0	0	1	1	0	0	-48dB
1	0	0	0	1	1	0	0	-49dB
0	1	0	0	1	1	0	0	-50dB
1	1	0	0	1	1	0	0	-51dB
0	0	1	0	1	1	0	0	-52dB
1	0	1	0	1	1	0	0	-53dB
0	1	1	0	1	1	0	0	-54dB

LV3311PNM

Sub volume control (-55dB to -∞)

D77	D78	D79	D80	D81	D82	D83	D84	Operation
1	1	1	0	1	1	0	0	-55dB
0	0	0	1	1	1	0	0	-56dB
1	0	0	1	1	1	0	0	-57dB
0	1	0	1	1	1	0	0	-58dB
1	1	0	1	1	1	0	0	-59dB
0	0	1	1	1	1	0	0	-60dB
1	0	1	1	1	1	0	0	-61dB
0	1	1	1	1	1	0	0	-62dB
1	1	1	1	1	1	0	0	-63dB
0	0	0	0	0	0	1	0	-64dB
1	0	0	0	0	0	1	0	-65dB
0	1	0	0	0	0	1	0	-66dB
1	1	0	0	0	0	1	0	-67dB
0	0	1	0	0	0	1	0	-68dB
1	0	1	0	0	0	1	0	-69dB
0	1	1	0	0	0	1	0	-70dB
1	1	1	0	0	0	1	0	-71dB
0	0	0	1	0	0	1	0	-72dB
1	0	0	1	0	0	1	0	-73dB
0	1	0	1	0	0	1	0	-74dB
1	1	0	1	0	0	1	0	-75dB
0	0	1	1	0	0	1	0	-76dB
1	0	1	1	0	0	1	0	-77dB
0	1	1	1	0	0	1	0	-78dB
1	1	1	1	0	0	1	0	-79dB
0	0	0	0	1	0	1	0	-∞

LPF

D85	D86	Operation
0	0	80Hz
1	0	120Hz
0	1	160Hz
1	1	OFF

Sub output select

D87	D88	Operation
0	0	FADER_REAR OUTPUT (LCH/RCH together)
1	0	LCH : FADER_REAR OUTPUT, RCH : SUBWOOFER OUTPUT
0	1	RCH : FADER_REAR OUTPUT, LCH : SUBWOOFER OUTPUT
1	1	SUBWOOFER OUTPUT (LCH/RCH together)

LV3311PNM

Fader block

D89	D90	D91	D92	D93	D94	LFOUT
D95	D96	D97	D98	D99	D100	LROUT
D101	D102	D103	D104	D105	D106	RFOUT
D107	D108	D109	D110	D111	D112	RROUT
0	0	0	0	0	0	0dB
1	0	0	0	0	0	-1dB
0	1	0	0	0	0	-2dB
1	1	0	0	0	0	-4dB
0	0	1	0	0	0	-6dB
1	0	1	0	0	0	-8dB
0	1	1	0	0	0	-10dB
1	1	1	0	0	0	-12dB
0	0	0	1	0	0	-14dB
1	0	0	1	0	0	-16dB
0	1	0	1	0	0	-18dB
1	1	0	1	0	0	-20dB
0	0	1	1	0	0	-30dB
1	0	1	1	0	0	-45dB
0	1	1	1	0	0	-60dB
1	1	1	1	0	0	-∞

Loudness control

D113	Operation
0	off
1	on

Zero cross control

D114	Operation
0	off
1	on

Zero cross signal detection block control

D115	D116	Operation
0	0	Input gain (LSELO)
1	0	Volume (LVROUT)
0	1	Fader (LFOUT)
1	1	Fader (LROUT)

D117	D118	Operation
0	0	Input gain (RSELO)
1	0	Volume (RVROUT)
0	1	Fader (RFOUT)
1	1	Fader (RROUT)

Soft step/Soft mute control

D119	Operation
0	Soft mute mode off
1	Soft mute mode on

D120	Operation
0	mute set off
1	mute set on

D121	Operation
0	Soft set off
1	Soft set on

D122	D123	Operation
0	0	normal mode
1	0	test mode

Soft step/Soft mute settling time select control

D124	D125	Operation
0	0	mute time 0.64ms
1	0	mute time 5.12ms
0	1	mute time 40ms
1	1	mute time 80ms

D126	D127	Operation
0	0	Soft step time 10ms
1	0	Soft step time 20ms
0	1	Soft step time 40ms
1	1	Soft step time 80ms

D128	D129	D130	D131	D132	D133	D134	D135
0	0	0	0	0	0	0	0

Usage Cautions

(1) Data Transmission at power on

- The status of internal analog switches is unstable at power on. Therefore, perform muting or some other countermeasure until the data has been set.
- At power on, initial setting data must be sent once in order to stabilize the bias of each block in a short time.

(2) Description of zero cross switching circuit operation

The LV3311PNM have a function to switch zero cross comparator signal detection locations, enabling the selection of the optimum detection location for blocks whose data is to be updated. Basically, the switching noise can be minimized by inputting the signal immediately following the block whose data is to be updated to the zero cross comparator, so it is necessary to switch the detection location every time.

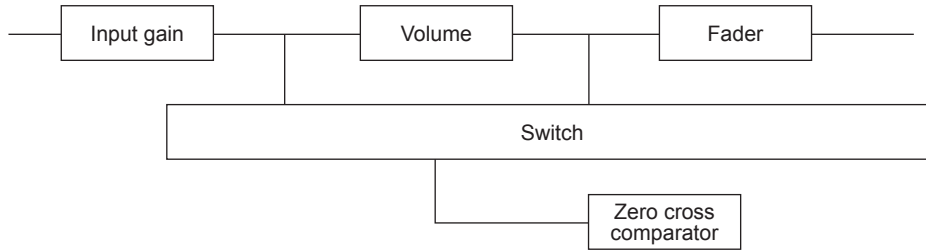

LV3311PNM zero cross detection circuit

(3) Zero Cross Switching Control method

The zero cross switching control method consists of setting the zero cross control bits to the zero cross detection mode, and specifying the detection blocks before transmitting the data. These control bits are latched immediately following data transfer, that is to say beforehand in sync with the falling edge of CE, so when updating data of volumes, etc., it is possible to perform mode setting and zero cross switching with one data transfer.

(4) Zero cross timer setting

If the input signal becomes lower than the zero cross comparator detection sensitivity, or if only low-frequency signals are input, zero cross detection continues to be impossible, and data is not latched during this time. The zero cross timer can set a time for forcible latch during such a status when zero cross detection is not possible.

(5) Soft step operation

The LV3311PNM have a soft step function at 3 band equalizer block and subwoofer block for low switching noise. The Soft step time can be selected by send to CCB control. (10ms, 20ms, 40ms, 80ms)
A soft step function can be implemented by set to soft step on. (Set to minimum step)

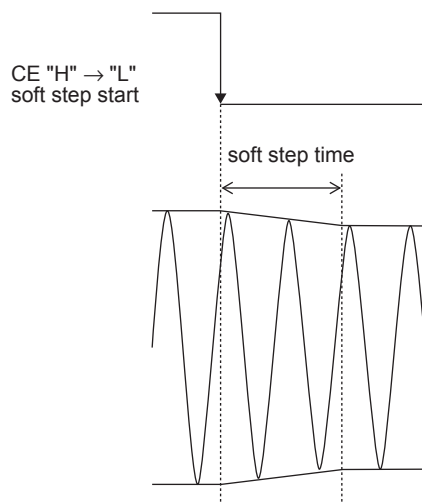

LV3311PNM

(6) Soft mute operation

The LV3311PNM have a soft mute function for low switching noise, when this mute function set operation. (mute/unmute function select)

The Soft mute time can be selected by send to CCB control. (0.6ms, 5ms, 40ms, 80ms)

A soft mute function can be implemented by set to soft mute on. (Set to mute on/off)

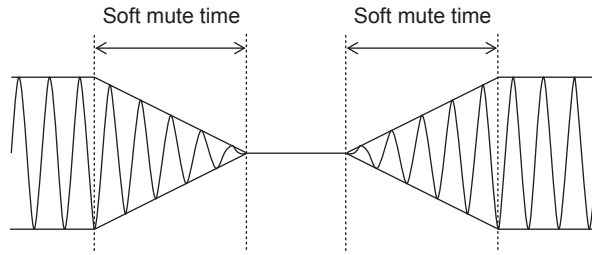

(7) The next set data must not be sent when zero cross operation is enabled or soft step/soft mute operation is performed.

Application Circuit Example

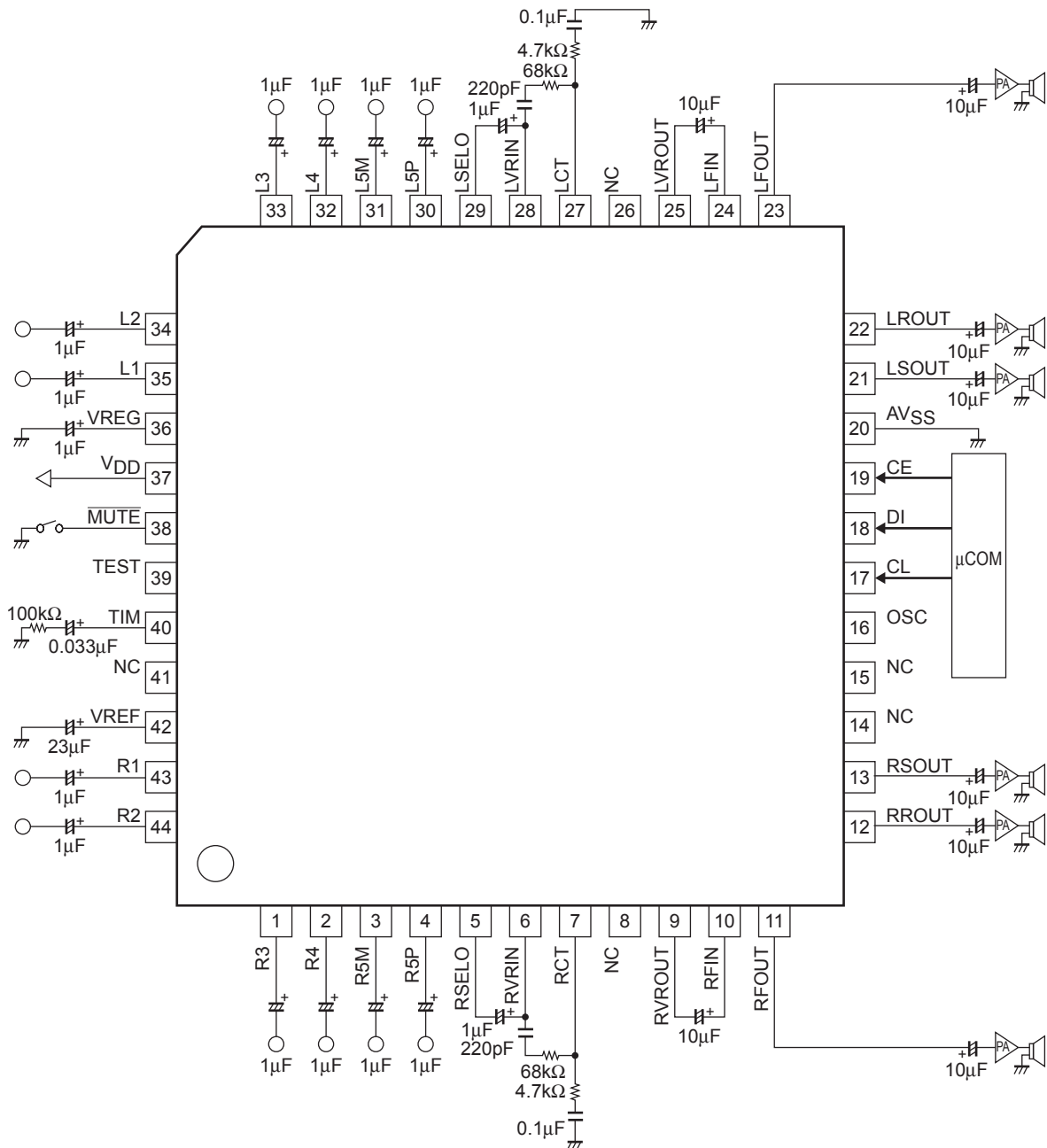

LV3311PNM

ORDERING INFORMATION

Device	Package	Shipping (Qty / Packing)
LV3311PNM-TLM-E	PQFP44 10x10 / QIP44M (Pb-Free)	1000 / Tape and Reel

† For information on tape and reel specifications, including part orientation and tape sizes, please refer to our Tape and Reel Packaging Specifications Brochure, BRD8011/D. http://www.onsemi.com/pub_link/Collateral/BRD8011-D.PDF

ON Semiconductor and the ON Semiconductor logo are trademarks of Semiconductor Components Industries, LLC dba ON Semiconductor or its subsidiaries in the United States and/or other countries. ON Semiconductor owns the rights to a number of patents, trademarks, copyrights, trade secrets, and other intellectual property. A listing of ON Semiconductor's product/patent coverage may be accessed at www.onsemi.com/site/pdf/Patent-Marking.pdf. ON Semiconductor reserves the right to make changes without further notice to any products herein. ON Semiconductor makes no warranty, representation or guarantee regarding the suitability of its products for any particular purpose, nor does ON Semiconductor assume any liability arising out of the application or use of any product or circuit, and specifically disclaims any and all liability, including without limitation special, consequential or incidental damages. Buyer is responsible for its products and applications using ON Semiconductor products, including compliance with all laws, regulations and safety requirements or standards, regardless of any support or applications information provided by ON Semiconductor. "Typical" parameters which may be provided in ON Semiconductor data sheets and/or specifications can and do vary in different applications and actual performance may vary over time. All operating parameters, including "Typicals" must be validated for each customer application by customer's technical experts. ON Semiconductor does not convey any license under its patent rights nor the rights of others. ON Semiconductor products are not designed, intended, or authorized for use as a critical component in life support systems or any FDA Class 3 medical devices or medical devices with a same or similar classification in a foreign jurisdiction or any devices intended for implantation in the human body. Should Buyer purchase or use ON Semiconductor products for any such unintended or unauthorized application, Buyer shall indemnify and hold ON Semiconductor and its officers, employees, subsidiaries, affiliates, and distributors harmless against all claims, costs, damages, and expenses, and reasonable attorney fees arising out of, directly or indirectly, any claim of personal injury or death associated with such unintended or unauthorized use, even if such claim alleges that ON Semiconductor was negligent regarding the design or manufacture of the part. ON Semiconductor is an Equal Opportunity/Affirmative Action Employer. This literature is subject to all applicable copyright laws and is not for resale in any manner.