

SANYO Semiconductors

DATA SHEET

An ON Semiconductor Company

LV5026M — Bi-CMOS IC LED Driver IC

Overview

LV5026M is a High voltage LED drive controller which drives LED current up to 3A with external MOSFET. LV5026M is realized very simple LED circuits with a few external parts. It corresponds to various wide dimming controls including the TRIAC dimming control.

Note) This LV5026M is designed or developed for general use or consumer appliance. Therefore, it is NOT permitted to use for automotive, communication, office equipment, industrial equipment.

Functions

- High voltage LED controller
- Various Dimming Control
 - TRIAC & Analog Input & PWM Input
- Soft Start function
- Built-in TRIAC stabilized function
- Built-in circuit of detection of overvoltage of CS pin.
- Selectable Switching frequency [50kHz or 70kHz, open: 50kHz]
- Short protection circuit
- Selectable reference Voltage
 - Internal 0.605V & External Input Voltage
- Low noise switching system/skip frequency function
 - 5 stages skip mode Frequency
 - Soft driving

Specifications

Maximum Ratings at Ta = 25°C

Parameter	Symbol	Conditions	Ratings	Unit
Maximum input voltage	V _{IN} max (Note1)		-0.3 to 42	V
REF_OUT, REF_IN, RT, CS, PWM_D, ACS			-0.3 to 7	V
OUT1 pin	V _{OUT_abs}		-0.3 to 42	V
OUT2 pin	V _{OUT2_abs}		-0.3 to 42	V
Allowable power dissipation	Pd max	With specified board*	1.0	W

Continued on next page.

- Any and all SANYO Semiconductor Co.,Ltd. products described or contained herein are, with regard to "standard application", intended for the use as general electronics equipment. The products mentioned herein shall not be intended for use for any "special application" (medical equipment whose purpose is to sustain life, aerospace instrument, nuclear control device, burning appliances, transportation machine, traffic signal system, safety equipment etc.) that shall require extremely high level of reliability and can directly threaten human lives in case of failure or malfunction of the product or may cause harm to human bodies, nor shall they grant any guarantee thereof. If you should intend to use our products for new introduction or other application different from current conditions on the usage of automotive device, communication device, office equipment, industrial equipment etc. , please consult with us about usage condition (temperature, operation time etc.) prior to the intended use. If there is no consultation or inquiry before the intended use, our customer shall be solely responsible for the use.
- Specifications of any and all SANYO Semiconductor Co.,Ltd. products described or contained herein stipulate the performance, characteristics, and functions of the described products in the independent state, and are not guarantees of the performance, characteristics, and functions of the described products as mounted in the customer's products or equipment. To verify symptoms and states that cannot be evaluated in an independent device, the customer should always evaluate and test devices mounted in the customer's products or equipment.

SANYO Semiconductor Co., Ltd.
<http://semicon.sanyo.com/en/network>

LV5026M

Continued from preceding page.

Parameter	Symbol	Conditions	Ratings	Unit
Junction temperature	T _j		150	°C
Operating junction temperature	Topj (Note2)		-30 to +125	°C
Storage temperature	Tstg		-40 to +150	°C

*1 Specified board: 58.0mm x 54.0mm x 1.6mm (glass epoxy board)

Note1) Absolute maximum ratings represent the values which cannot be exceeded for any length of time.

Note2) Even when the device is used within the range of absolute maximum ratings, as a result of continuous usage under high temperature, high current, high voltage, or drastic temperature change, the reliability of the IC may be degraded. Please contact us for the further details.

Recommended Operating Conditions at Ta = 25°C

Parameter	Symbol	Conditions	Ratings	Unit
Input voltage	V _{IN}		8.5 to 24	V

* Note : supply the stabilized voltage.

Electrical Characteristics at Ta = 25°C, V_{IN} = 12V, unless otherwise specified.

Parameter	Symbol	Conditions	Ratings			Unit
			min	typ	max	
Reference voltage block						
Built-in reference voltage	VREF		0.585	0.605	0.625	V
VREF V _{IN} line regulation	VREF_LN	V _{IN} = 8.5 to 24V		±0.5		%
Reference output voltage	REFOUT	I _{REFOUT} = 0.5mA		3.0		V
- Maximum load	REFOUT_MAX		0.5			mA
- equivalent output impedance	REFOUT_RO			10		Ω
Under voltage lockout						
Operation start Input voltage	UVLOON		8	9	10	V
Operation stop input voltage	UVLOOFF		6.3	7.3	8.3	V
Hysteresis voltage	UVLOH			1.7		V
Oscillation						
Frequency	FOSC1	RT = OPEN	40	50	60	kHz
	FOSC2	RT = REF_OUT	55	70	85	kHz
FOSC1 Switch voltage	V _O SC1		2		5	V
FOSC2 Switch voltage	V _O SC2				0.5	V
Maximum ON duty	MAXDuty			93		%
Comparator						
Input offset voltage (Between CS and VREF)	V _{IO_V} R			1	10	mV
Input offset voltage (Between CS and REF _{IN})	V _{IO_R} I			1	10	mV
Input current	I _{IO} SC			160		nA
	I _{IO} REF			80		nA
CS pin max voltage	VOM				1	V
malfunction prevention mask time	TMSK			150		ns
PWM_D circuit						
OFF voltage	V _{OFF}		2		5	V
ON voltage	V _{ON}		0		0.6	V
Thermal protection circuit						
Thermal shutdown temperature	TSD	*Design guarantee		165		°C
Thermal shutdown hysteresis	ΔTSD	*Design guarantee		30		°C
Drive Circuit						
OUT sink current	I _O I		500	1000		mA
OUT source current	I _O O			120		mA
Minimum On time	TMIN			200	300	ns

Continued on next page.

LV5026M

Continued from preceding page.

Parameter	Symbol	Conditions	Ratings			Unit
			min	typ	max	
TRIAC Stabilization circuit						
Threshold of OUT2	V_{ACS}	OUT2 = High [less than right record]	2.8	3.0	3.2	V
OUT2 sink current	I_{O2I}	$V_{IN} = 12V, OUT2 = 6V$		0.6		mA
OUT2 source current	I_{O2O}	$V_{IN} = 12V, OUT2 = 6V$		0.6		mA
VCC current						
UVLO mode V_{IN} current	I_{CCOFF}	$V_{IN} < UVLOON$		80	120	μA
Normal mode V_{IN} current	I_{CCON}	$V_{IN} > UVLOON, OUT = OPEN$		0.6		mA
V_{IN} over voltage protection circuit						
V_{IN} over voltage protection voltage	V_{INOV}		24	27	30	V
V_{IN} current at OVP	I_{INOV}	$V_{IN} = 30V$	0.7	1.0	1.5	mA
CS terminal abnormal sensing circuit						
Abnormal sensing voltage	CSOCP			1.9		V

*: Design guarantee (value guaranteed by design and not tested before shipment)

Package Dimensions

unit : mm (typ)

3086B

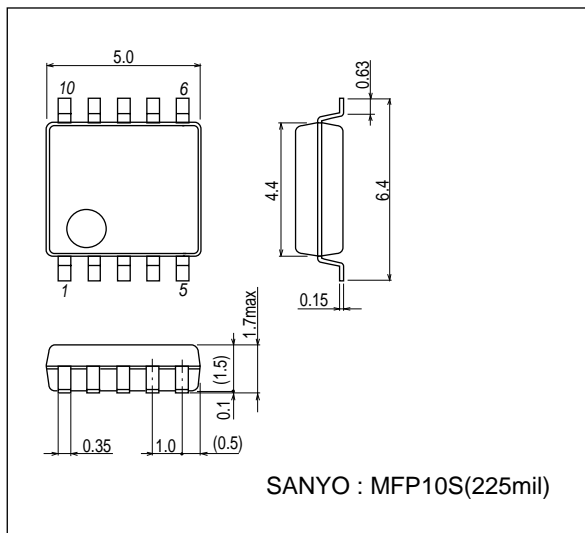

Pin Assignment

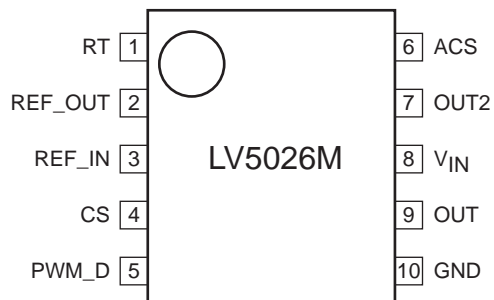

(Top view)

LV5026M

Pin Functions

Pin No.	Pin name	Pin function	Equivalent circuit
1	RT	Switching frequency selection pin. L or Open : 50kHz switching, H: 70 kHz switching. In case of 70kHz,connect RT pin to REFOUT pin. on time	
2	REF_OUT	Built-in 3V Regulate out Pin. If this function isn't used, please connect to nothing.	
3	REF_IN	External LED current Limit Setting pin. If less than VREF (0.61V) voltage is input, Peak current value is used at the input voltage. If more than REF_IN voltage is input, it is done at VREF voltage. If this function isn't used, please connect nothing.	
4	CS	LED current sensing in. If this terminal voltage exceeds VREF (Or REF_IN), external FET is OFF. And if the voltage of the terminal exceeds 1.9V, LV5026M turns to latch-off mod	
5	PWM_D	PWM Dimming pin.L or open: normal operation, H: Stop operation.	
6	GND	GND pin.	
7	OUT	Driving the external FET Gate Pin.	
8	V_IN	Power supply pin. Operation : $V_{IN} > UVLOON$ Stop: $V_{IN} < UVLOOFF$ Switching Stop : $V_{IN} > V_{IN}OVP$	
9	OUT2	This pin drive the FET which is stabilized the TRIAC dimming application. If ACS is less than 3V, OUT2 turn High voltage. If this function isn't used, please connect nothing.	
10	ACS	ACS pin senses AC Voltage. If this function isn't used, please connect GND.	

LED current and inductance setting

- Relation ship between REF_IN and CS pin voltage(Power Factor Crrction(PFC))

The output current value is the average of the current value that flows during one cycle. The current value that flows into coil is a triangular wave shown in the figure below. Make sure to set I_{pk} so that (average of current value at one cycle) is equal to (LED current value). I_{pk} is set by the relationship between REF_IN voltage and R_{cs} voltage.

This relationship make Power Factor Correction (PFC). Therefore, it is available to make LED current a sine curve.

- Setting Zener voltage

V_{zd} depend on LED voltage (Vf). Choose Zener diode around Vf (LED voltage). When VAC voltage is lower than Vf, LED operation is not normal. Using Zener diode prevents incorrect operating during VAC voltage lower than Vf. In detail, refer to [LED current and inductance setting]

In case of REF_IN pin open, this error amplifier negative input(-) is under control of internal VREF voltage (0.605V typ).

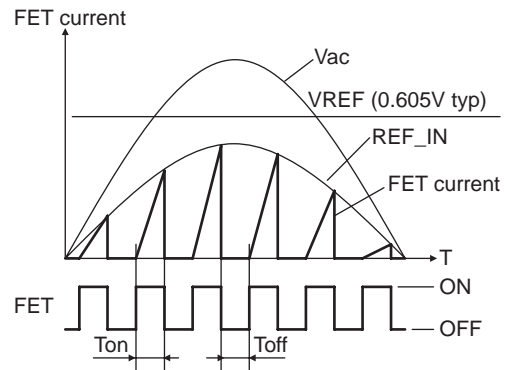
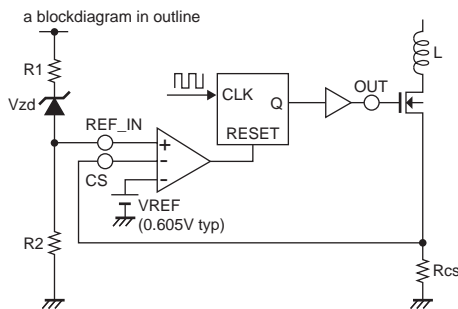

$$I_{pk} = \frac{(V_{ac} - V_{zd}) \times \frac{R_2}{R_1 + R_2}}{R_{cs}}$$

- I_{pk} : peak inductor current
- V_f : LED forward voltage drop
- V_{ac} : effective value, R.M.S value
- V_{REF} : Built-in reference voltage (0.605V)
- V_{REF_IN} : REF_IN voltage (6 pin)
- R_s : External sense resistor
- V_{zd} : Zener diode voltage (REF_IN pin)

LED current and inductance setting

It is available to use both no-isolation and isolation applications.

(For non-isolation application)

The output current value is the average of the current value that flows during one cycle. The current value that flows into coil is a triangular wave shown in the figure below. Make sure to set IL_PK so that (average of current value at one cycle) is equal to (LED current value).

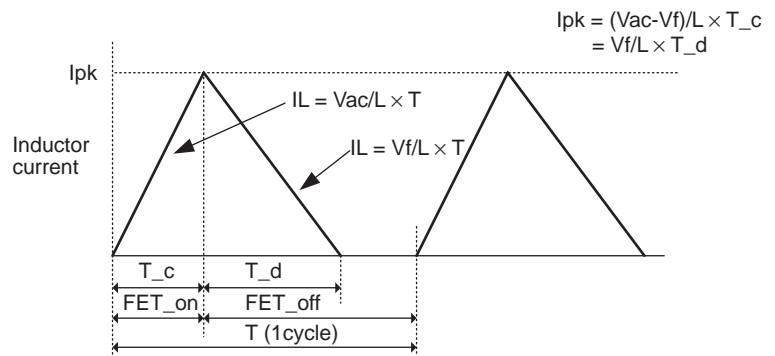
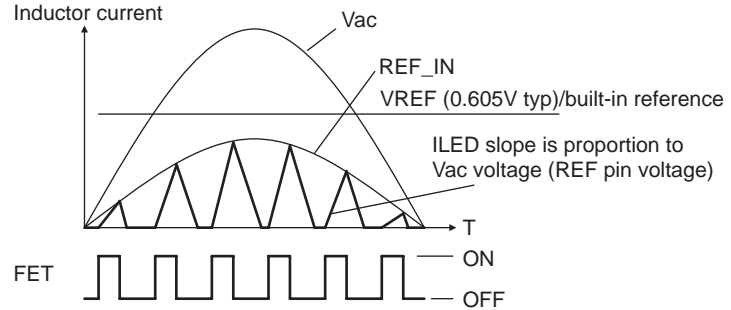
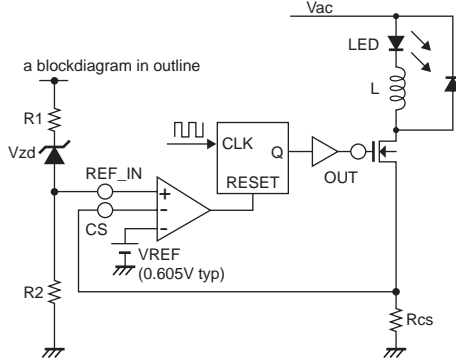

Given that the period when current flows into coil is

$$\text{Duty}I = \frac{T_c + T_d}{T}$$

$$I_{pk} \times \frac{1}{2} \times (\text{Duty} \times T) / T = I_{LED}$$

$$I_{pk} \times \frac{2 \times I_{LED}}{\text{Duty}I} \quad (1) \text{ since } I_{pk} \times \frac{V_{REF_IN}}{R_{cs}}$$

$$R_{cs} \times \frac{V_{REF_IN}}{I_{pk}} = \frac{\text{Duty}I \times V_{REF_IN}}{2I_{LED}} \quad (2)$$

Ipk: peak inductor current
 Vf: LED forward voltage drop
 Vac: effective value(R.M.S value)
 VREF: Built-in reference voltage (0.605V)
 VREF_IN: REF_IN voltage (6 pin)
 Rs: External sense resistor
 Vzd: Zener diode voltage (REF_IN pin)

Since formula for LED current is different between on period and off period as shown above,

$$I_{pk} \times \frac{Vac - Vf}{L} \times T_c = \frac{Vf}{L} \times T_d \quad (3)$$

$$\text{Since } T_c + T_d = \text{Duty}I \times T, T_c = \text{Duty}I \times T - T_d \quad (4)$$

$$\text{Based on the result of (3) and (4), } T_d = \text{Duty}I \times T \times \frac{Vac - Vf}{Vac} \quad (5)$$

To obtain L from the equation (1), (3), (5),

$$L \times \frac{Vf \times \text{Duty}I}{2 \times I_{LED}} \times \text{Duty}I \times T = \frac{Vac - Vf}{Vac} = \frac{Vf}{2 \times I_{LED}} \times \frac{1}{f_{osc}} \times \frac{Vac - Vf}{Vac} \times (\text{Duty}I)^2 \quad (6)$$

Since LED and inductor are connected in serial in non-isolation mode, LED current flows only when AC voltage exceed VF.

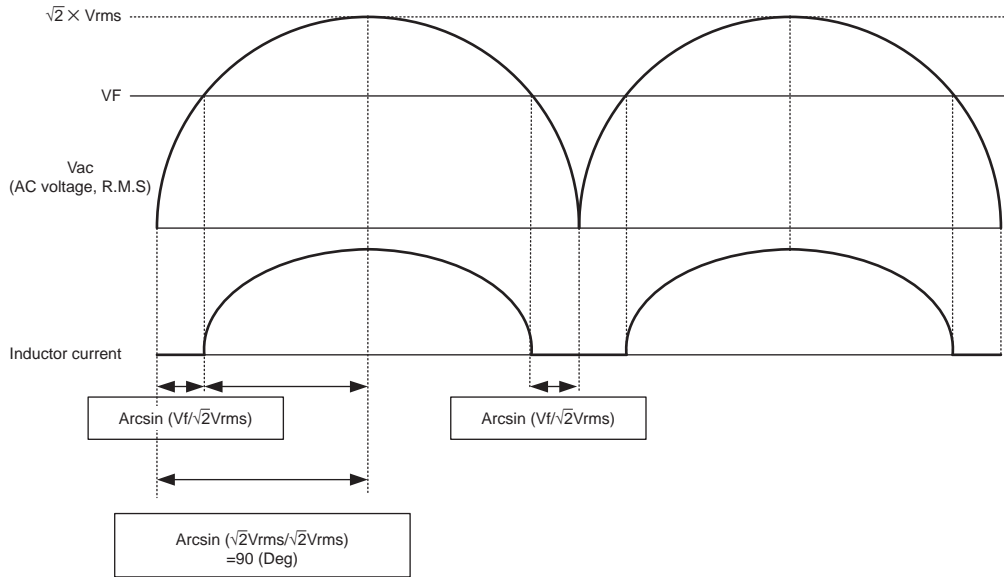

Given that the ratio of inductor current to AC input is DutyAC.

$$DutyAC = \frac{90 - \arcsin\left(\frac{Vf}{\sqrt{2}Vrms}\right)}{90}$$

Since the period when the inductor current flows are limited by DutyAC, the formula (6) is represented as follows:

$$L = \frac{Vf}{2 \times I_{LED}} \times \frac{1}{f_{osc}} \times \frac{Vac - Vf}{V_{IN}} \times (DutyI)^2 \times \left(\frac{90 - \arcsin\left(\frac{Vf}{\sqrt{2}Vrms}\right)}{90}\right)^2 \quad (7)$$

LV5026M

(for Isolation circuit)

Using the circuit diagram below, the wave form of the current that flows to Np and Ns is as follows.
Current waveform flows to primary side and secondary.

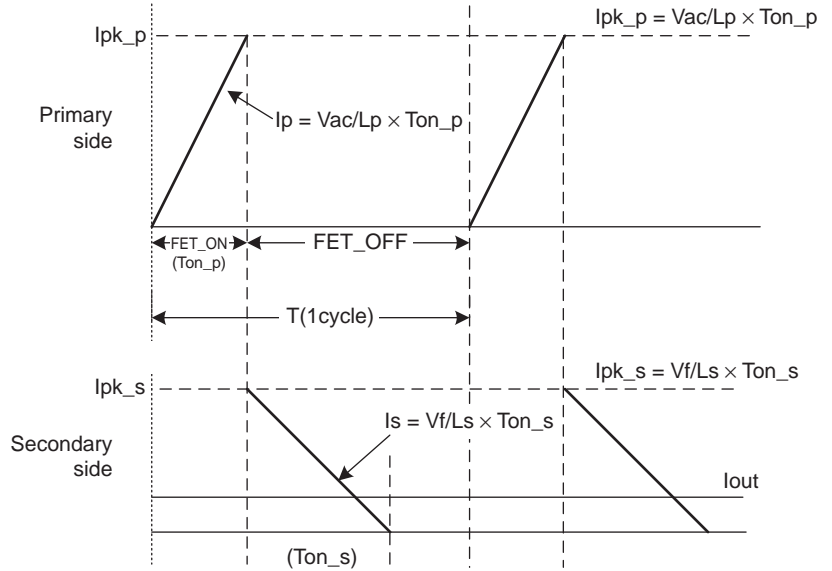
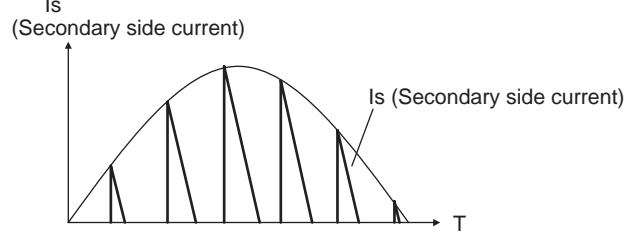
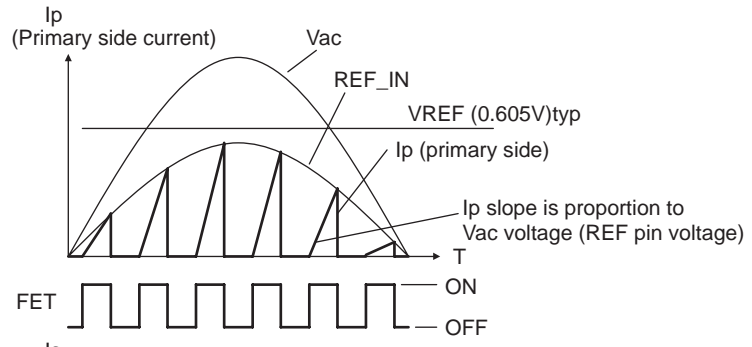
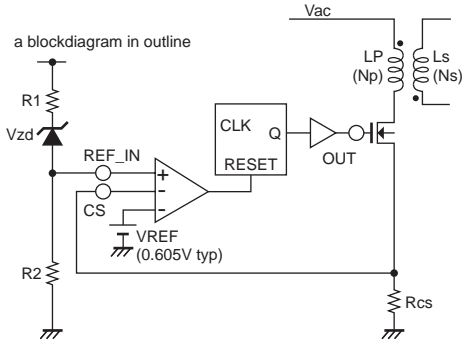

[Inductance Lp of primary side and sense resistor Rs]

If a peak current flow to transformer is represented as Ipk_p, the power (Pin) charged to the transformer on primary side can be represented as:

$$Pin = \frac{1}{2} \times Lp \times (Ipk_p)^2 \times fosc \quad (11)$$

$$Ipk_p = \frac{Vac}{Lp} \times Ton_p \quad (12)$$

$$Lp = \frac{Vac^2 \times Ton_p^2 \times fosc}{2 \times Pin} = \frac{Vac^2 \times Don_p^2}{2 \times Pin \times fosc} \quad (13)$$

$$(Don_p = \frac{Ton_p}{T} = Ton_p \times fosc),$$

To substitute the following to the formula below,

$$\therefore \eta = \frac{Pout}{Pin} \quad (14)$$

$$\therefore Lp = \frac{Vac^2 \times Ton_p^2 \times fosc \times \eta}{2 \times Pout} = \frac{Vac^2 \times Don_p^2 \times \eta}{2 \times Pout \times fosc} \quad (15)$$

Sense resistor is obtained as follows.

$$R_s = \frac{VREF_IN}{Ipk_p} = \frac{VREF_IN \times Lp}{Vac \times Ton_p} = \frac{VREF_IN \times Lp}{Vac \times Don_p \times T} \quad (16)$$

[Inductance L_s of secondary side]

Since output current I_{out} is the average value of current flows to transformer of secondary side

$$I_{out} = Ipk_s \times \frac{Ton_s}{T} \times \frac{1}{2} = \frac{Ipk_s \times Don_s}{2} \quad (Don_s = \frac{Ton_s}{T} = Ton_s \times fosc) \quad (17)$$

$$Ipk_s = \frac{Vout}{Ls} \times Ton_s = \frac{Vout}{Ls} = \frac{Don_s}{fosc} \quad (18)$$

$$Ls = \frac{Vout \times T \times Don_s^2}{2 \times I_{out}} = \frac{Vout \times Don_s^2}{2 \times I_{out} \times fosc} = \frac{Vout^2 \times Don_s^2}{2 \times Pout \times fosc} \quad (19)$$

Calculation of the ratio of transformer coil on primary side and secondary side

Since ratio and inductance of transformer coil is

$$\frac{Ns}{Np} = \frac{\sqrt{Ls}}{\sqrt{Lp}} \quad (20)$$

substituted equations (15), (19) for (20)

$$\therefore \frac{Np}{Ns} = \frac{Vac}{Vout} \times \sqrt{\eta} \times \frac{Don_p}{Don_s} \quad (21)$$

Calculation of transformer coil on primary side and secondary side

$$N = \frac{Vac \times 10^8}{2 \times \Delta B \times Ae \times fosc} \quad (22)$$

ΔB : variation range of core flux density [Gauss]

Ae : core section area [cm²]

To use Al (L value at 100T),

$$N = \sqrt{\frac{L}{Al}} \times 10^2 \quad (23)$$

L: inductance [μ H]

Al: L value at 100T [uH/N²]

lg (Air gap) is obtained as follows:

$$lg = \frac{\mu_r \mu_0 N^2 Ae 10^2}{L} \quad (24)$$

μ_r : relative magnetic permeability, $\mu_r = 1$

μ_0 : vacuum magnetic permeability $\mu_0 = 4\pi \times 10^{-7}$

N: turn count [T]

Ae : core section area [m²]

L: inductance [H]

LV5026M

Bleeder current circuit for TRIAC dimmer

1. Operating voltage setting

ACS pin voltage set operating voltage at OUT2. ACS pin threshold voltage is 3V typ.

OUT2 operating voltage is set by R1 and R2. R1 and R2 is determined below.

$$ACS = Vac \times \frac{R2}{R1+R2}$$

2. Bleeder current setting

Rd set hold current at Triac dimmer.

Bleeder current is set at Rd depending on Triac dimmer.

a blockdiagram in outline

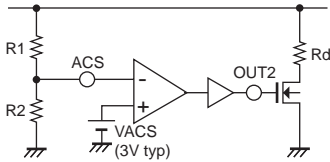

a blockdiagram in outline

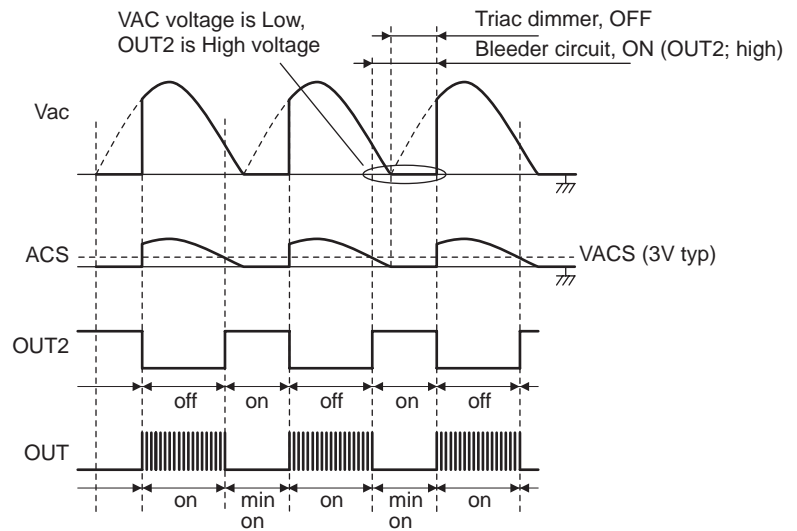

LV5026M

Description of operation protection function

	tilte	outline	monitor point	note
1	UVLO	Under voltage lock out	V _{CC} voltage	
2	OCP	Over current protection	CS voltage	available FET current
3	OVP	Over voltage protection	V _{CC} voltage	
4	OTP (TSD)	Over Temperature Protection (Thermal Shut Down)	PN Junction temperature	

1. UVLO (Under voltage lock out)

If V_{IN} voltage is 7.3V or lower, then UVLO operates and the IC stops. When UVLO operates, the power supply current of the IC is about 80μA or lower. If V_{IN} voltage is 9V or higher, then the IC starts switching operation.

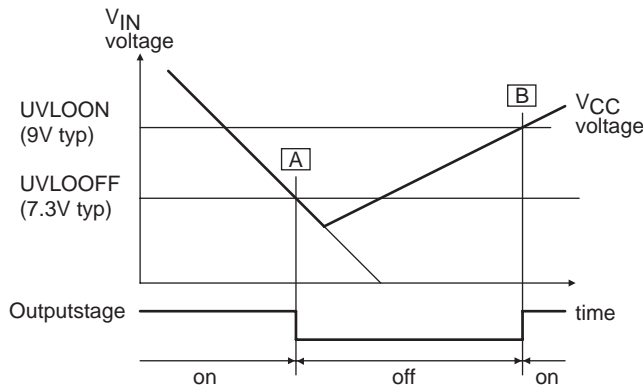

2. UVLO (Under voltage lock out)

The CS pin sense the current through the MOS FET switch and the primary side of the transformer. This provides an additional level of protection in the event of a fault. If the voltage of the CS pin exceeds VCSOCP (1.9V typ) (A), the internal comparator will detect the event and turn off the MOSFET. The peak switch current is calculated $I_o \text{ (peak) [A]} = V_{SOCP} \text{ [V]} / R_{sense} \text{ [\Omega]}$

The V_{CC} pin is pulled down to fixed level, keeping the controller latched off. The lach reset occurs when the user disconnects LED from VAC and lets the V_{CC} falls below the V_{CC} reset voltage, UVLOOFF (7.3V typ)(B). Then V_{CC} rise UVLOON (9V typ) (C), restart the switching.

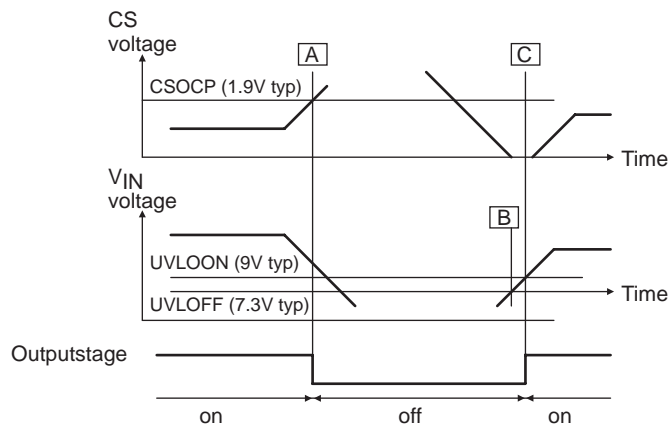

3. OVP (Over voltage protection)

If the voltage of V_{IN} pin is higher than the internal reference voltage V_{INOVP} (27V typ), switching operation is stopped.

The stopping operation is kept until the voltage of V_{IN} is lower than 7.3V. If the voltage of V_{IN} pin is higher than 9V, the switching operation is restated.

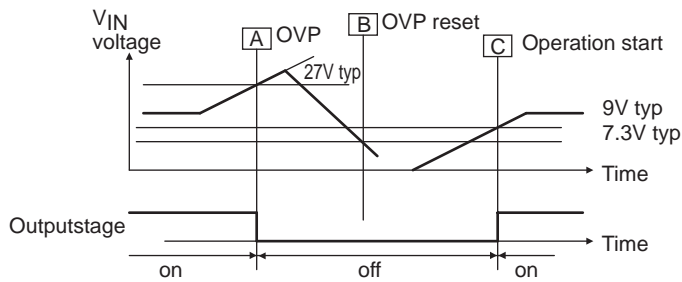

4. TSD (Thermal shut down protection)

The thermal shutdown function works when the junction temperature of IC is 165°C (typ) (A), and the IC switching stops. The IC starts switching operation again when the junction temperature is 135°C typ (B) or lower.

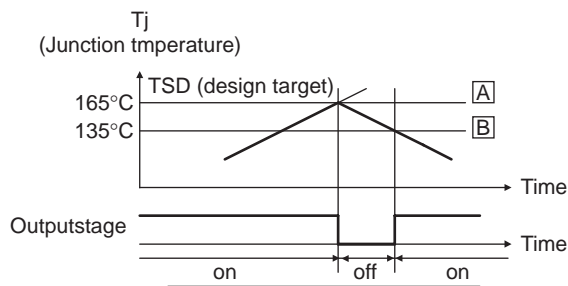

Skip frequency function

LV5026M contains the skip frequency function for reduction of the peak value of conduction noise. This function changes the frequency as follows.

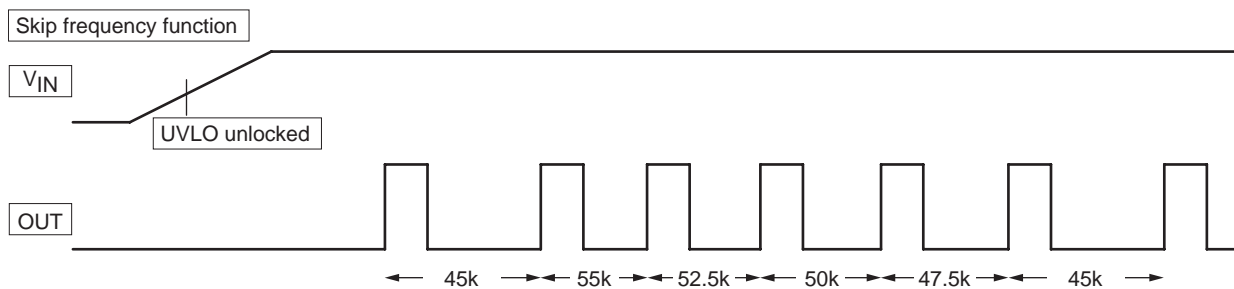

Switching frequency is changed as follows.

... $\times 0.9 \rightarrow \times 1.1 \rightarrow \times 1.05 \rightarrow \times 1 \rightarrow \times 0.95 \rightarrow \times 0.9 \rightarrow \times 1.1$...

It's repeated by this loop.

LV5026M

PWM dimmer function

LED current can be adjusted according to Duty of PWM pulse input to PWM dimmer pin. PWM pulse is High (2V to 5V) then switching operation stops, and LED current stops flowing. PWM pulse is Low (under 0.6V), then switching operation stop is released, and it returns to normal operation.

An outline of PWM_D pin

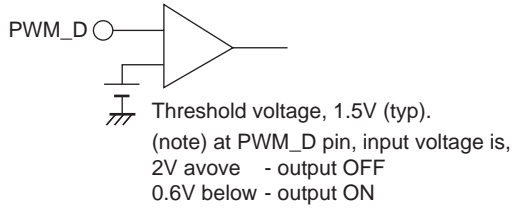

LED current vs PWM_D duty (outline)

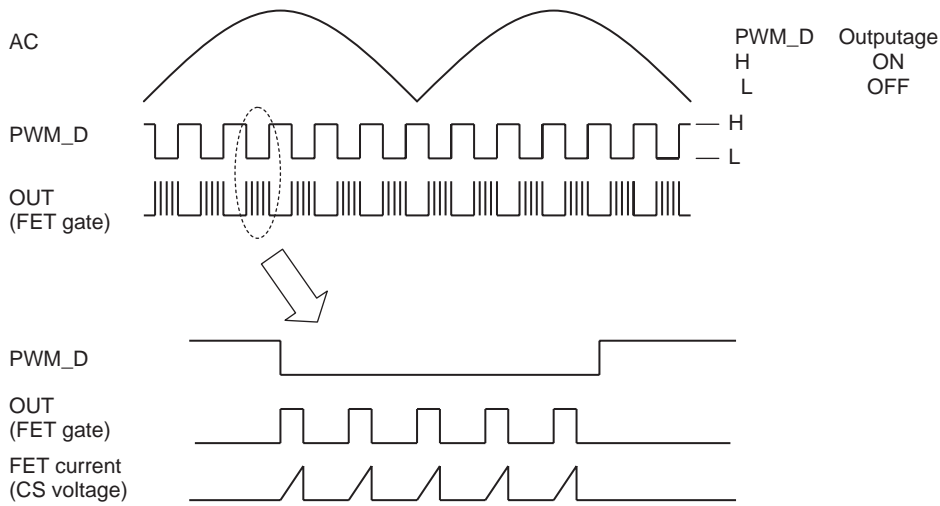
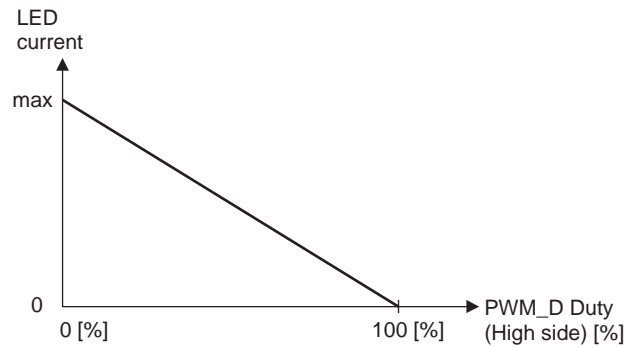

LV5026M

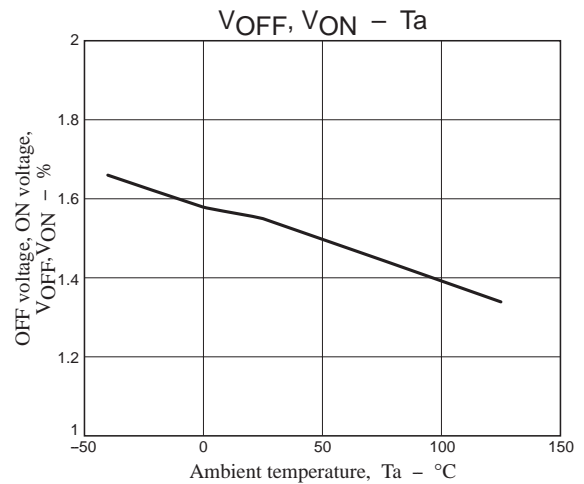
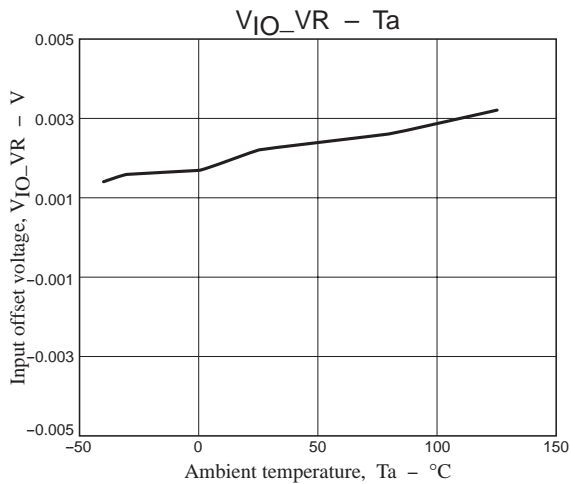
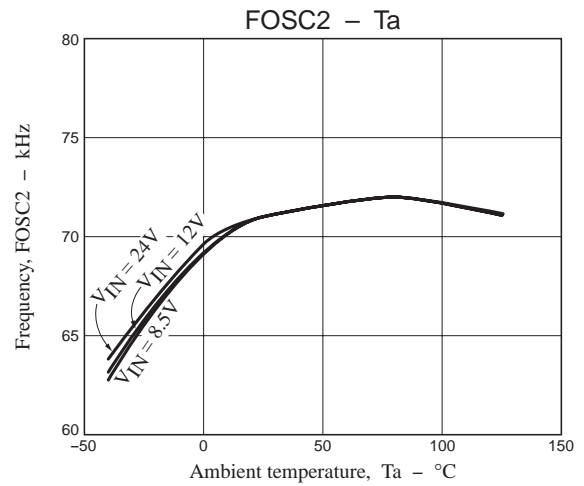
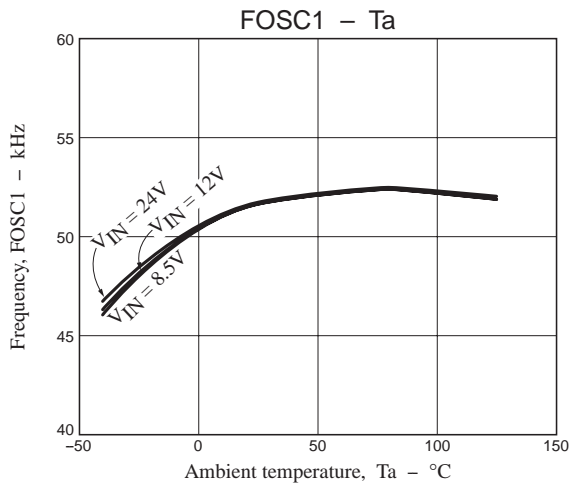
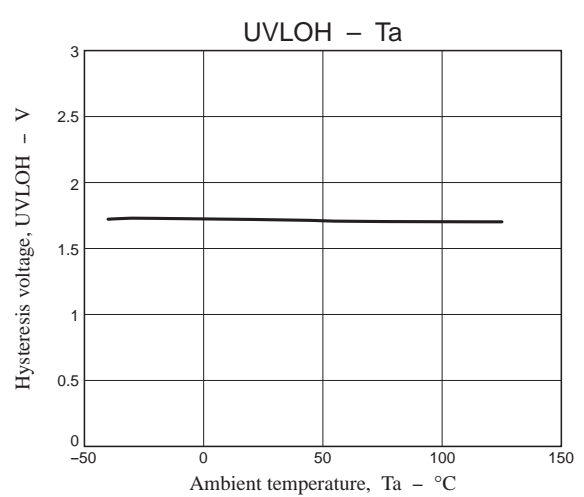
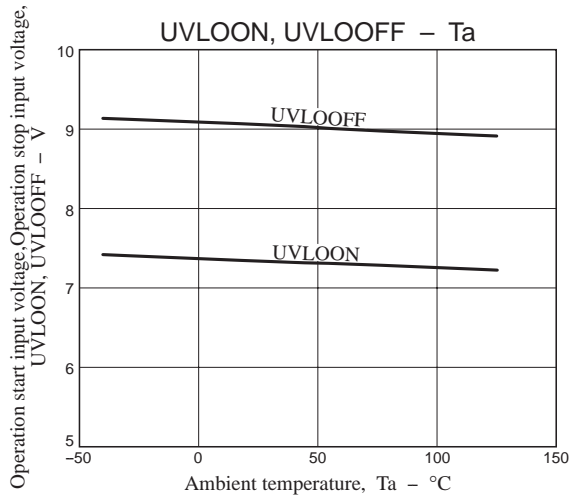
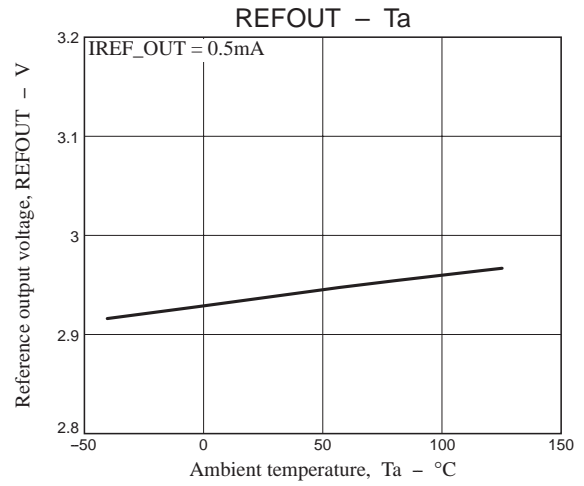
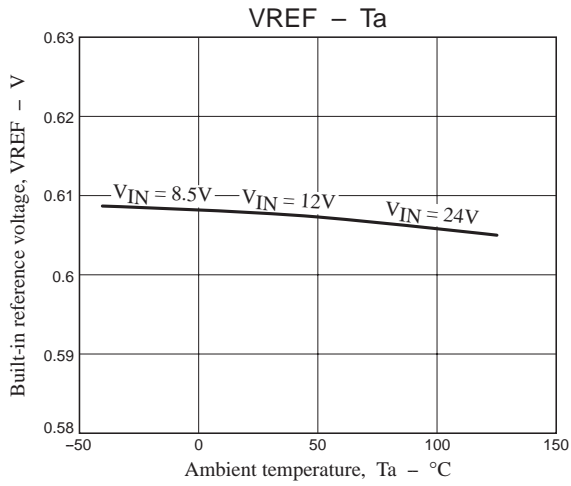

LV5026M

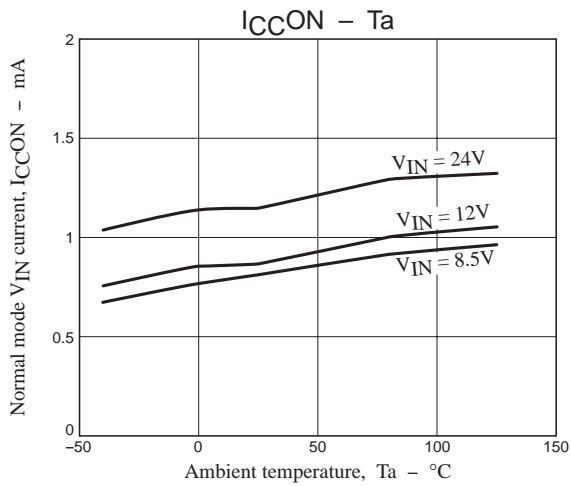
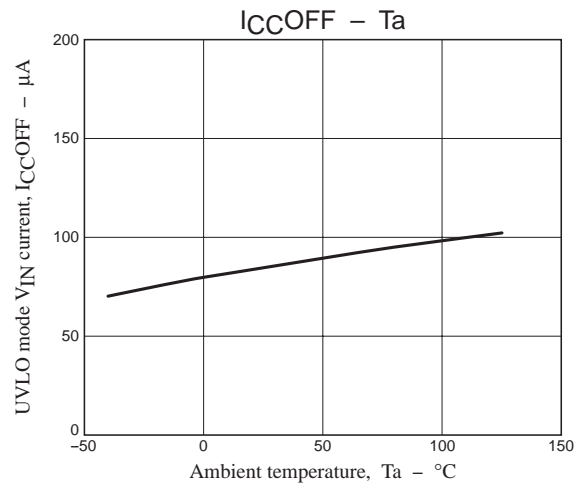
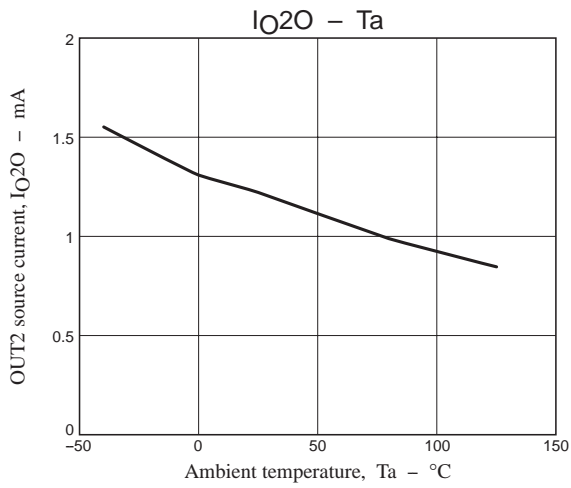
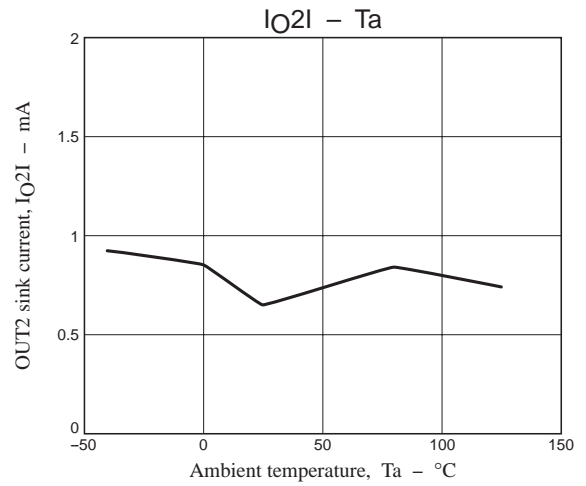
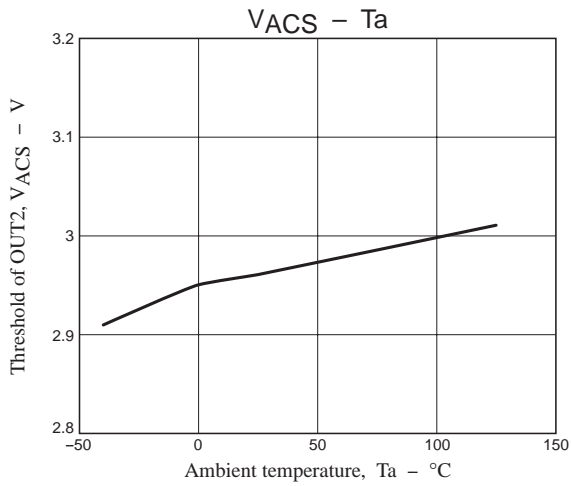
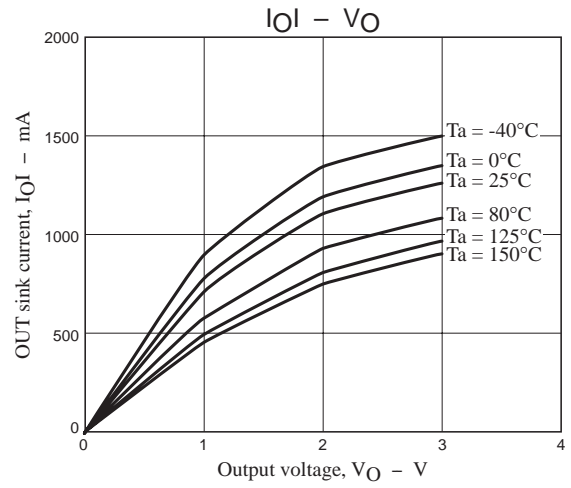
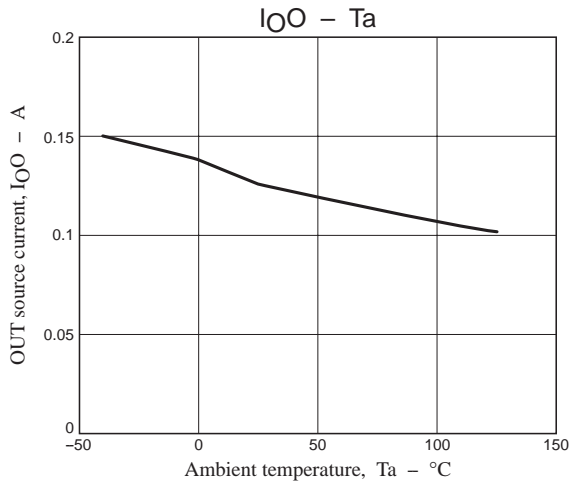

LV5026M

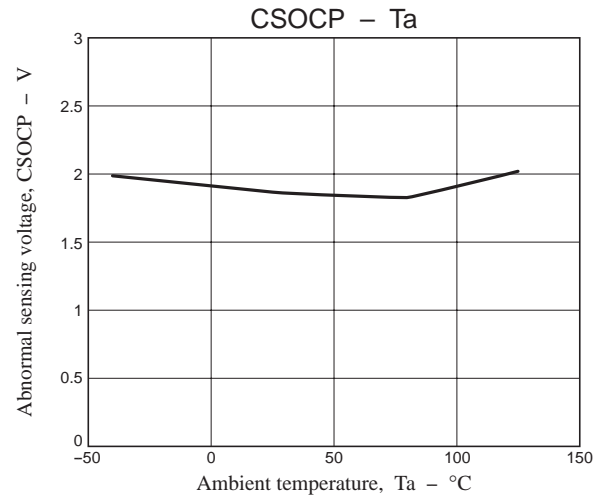
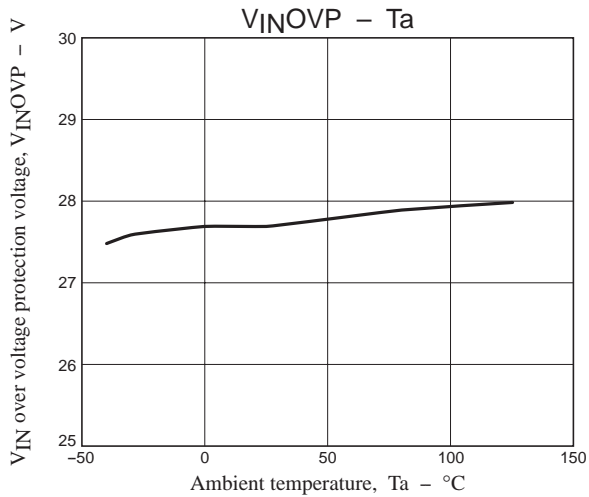

- SANYO Semiconductor Co.,Ltd. assumes no responsibility for equipment failures that result from using products at values that exceed, even momentarily, rated values (such as maximum ratings, operating condition ranges, or other parameters) listed in products specifications of any and all SANYO Semiconductor Co.,Ltd. products described or contained herein.
- SANYO Semiconductor Co.,Ltd. strives to supply high-quality high-reliability products, however, any and all semiconductor products fail or malfunction with some probability. It is possible that these probabilistic failures or malfunction could give rise to accidents or events that could endanger human lives, trouble that could give rise to smoke or fire, or accidents that could cause damage to other property. When designing equipment, adopt safety measures so that these kinds of accidents or events cannot occur. Such measures include but are not limited to protective circuits and error prevention circuits for safe design, redundant design, and structural design.
- In the event that any or all SANYO Semiconductor Co.,Ltd. products described or contained herein are controlled under any of applicable local export control laws and regulations, such products may require the export license from the authorities concerned in accordance with the above law.
- No part of this publication may be reproduced or transmitted in any form or by any means, electronic or mechanical, including photocopying and recording, or any information storage or retrieval system, or otherwise, without the prior written consent of SANYO Semiconductor Co.,Ltd.
- Any and all information described or contained herein are subject to change without notice due to product/technology improvement, etc. When designing equipment, refer to the "Delivery Specification" for the SANYO Semiconductor Co.,Ltd. product that you intend to use.
- Upon using the technical information or products described herein, neither warranty nor license shall be granted with regard to intellectual property rights or any other rights of SANYO Semiconductor Co.,Ltd. or any third party. SANYO Semiconductor Co.,Ltd. shall not be liable for any claim or suits with regard to a third party's intellectual property rights which has resulted from the use of the technical information and products mentioned above.

This catalog provides information as of December, 2011. Specifications and information herein are subject to change without notice.