



SANYO Semiconductors

DATA SHEET

An ON Semiconductor Company

LV5217GP — Bi-CMOS IC 3ch LED Driver

Overview

This LV5217GP is 3-channel LED driver for cell phones. Each LED driver current can be adjusted by I2C bus. LV5217GP can perform various illumination effects with a full-color LED display.

Features

- Three color LED driver circuits.
- The LED current can be switched independently in 7-bit units (0.31 to 25.48mA).
- Independent on/off control of the three LED drivers (independent control of the 3 RGB colors).
- Each LED drive current level can be adjusted independently over the I²C bus.
- Miniature package.
- Thermal shutdown circuit.

Specifications

Absolute Maximum Ratings at Ta = 25°C

Parameter	Symbol	Conditions	Ratings	Unit
Supply voltage 1	V _{CC} max		6.0	V
Supply voltage 2	V _{DD} max		6.0	V
Maximum input current	V _{INB}		6.0	V
Maximum output current	I _O max		30.0	mA
STBY pin voltage	V _{STBY}		6.0	V
Allowable power dissipation	P _d max	Mounted on the specified board *	0.55	W
Operating temperature	T _{opr}		-30 to +75	°C
Storage temperature	T _{stg}		-40 to +125	°C

The specified board * : 50mm × 40mm × 0.8mm glass epoxy (4-layer circuit board).

■ Any and all SANYO Semiconductor Co.,Ltd. products described or contained herein are, with regard to "standard application", intended for the use as general electronics equipment (home appliances, AV equipment, communication device, office equipment, industrial equipment etc.). The products mentioned herein shall not be intended for use for any "special application" (medical equipment whose purpose is to sustain life, aerospace instrument, nuclear control device, burning appliances, transportation machine, traffic signal system, safety equipment etc.) that shall require extremely high level of reliability and can directly threaten human lives in case of failure or malfunction of the product or may cause harm to human bodies, nor shall they grant any guarantee thereof. If you should intend to use our products for applications outside the standard applications of our customer who is considering such use and/or outside the scope of our intended standard applications, please consult with us prior to the intended use. If there is no consultation or inquiry before the intended use, our customer shall be solely responsible for the use.

■ Specifications of any and all SANYO Semiconductor Co.,Ltd. products described or contained herein stipulate the performance, characteristics, and functions of the described products in the independent state, and are not guarantees of the performance, characteristics, and functions of the described products as mounted in the customer's products or equipment. To verify symptoms and states that cannot be evaluated in an independent device, the customer should always evaluate and test devices mounted in the customer's products or equipment.

SANYO Semiconductor Co., Ltd.

<http://semicon.sanyo.com/en/network>

LV5217GP

Recommended Operating Conditions at Ta = 25°C

Parameter	Symbol	Conditions	Ratings	Unit
Supply voltage 1	V _{CC}		3.0 to 4.5	V
Supply voltage 2	V _{DD}		1.6 to 3.0	V

Electrical Characteristics Ta = 25°C, V_{CC} = 3.7V, V_{DD} = 1.8V, RT = 56kΩ, Unless otherwise specified.

Parameter	Symbol	Conditions	Ratings			Unit
			min	typ	max	
Overall Characteristics						
Current drain 1	I _{CC1}	STBY = L *1			5	μA
Current drain 2	I _{CC2}	STBY = H, LED ON= L *1 With the default serial data settings		0.7	2	mA
High-level input voltage 1	V _{INH1}	Serial data signals, LEDON pin	V _{DD} ×0.8			V
Low-level input voltage 1	V _{INL1}	Serial data signals, LEDON pin	0		V _{DD} ×0.2	V
High-level input voltage 2	V _{INH2}	STBY pin	1.4			V
Low-level input voltage 2	V _{INL2}	STBY pin	0		0.2	V
LED Driver Block						
Minimum output current	I _{MIN}	When the serial data is 0000001, V _O = 0.5V	0.0	0.2	1.0	mA
Maximum output current	I _{MAX}	When the serial data is 1111111, V _O = 0.5V	23.0	25.4	28.0	mA
LED current value accuracy	IDIF	When current value is set to 4mA (0010011)	-8		8	%
Differential linearity error	DLE	*2	-2		2	LSB
LED pin saturation voltage	V _{LED}	At the maximum current setting			0.3	V
Leakage current	I _{LEAK}	Drivers : off, V _O = 5V			1	μA

V_O : LED pin voltage.

*1. The sum of the V_{CC} and V_{DD} current drain values.

*2. Differential linearity error : The difference between the actual and ideal amounts when one low-order bit value is added.

Package Dimensions

unit : mm (typ)

3318

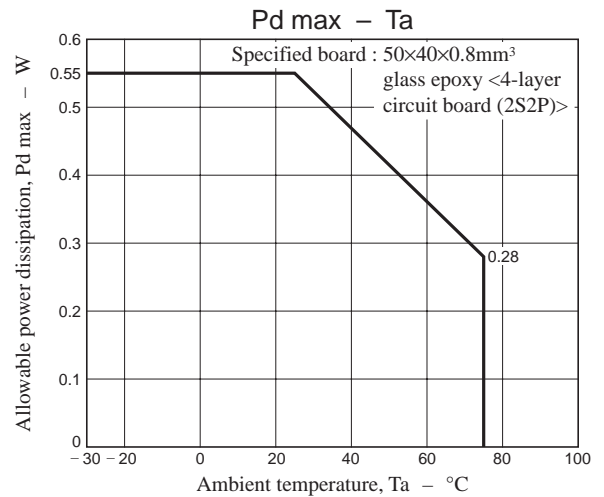
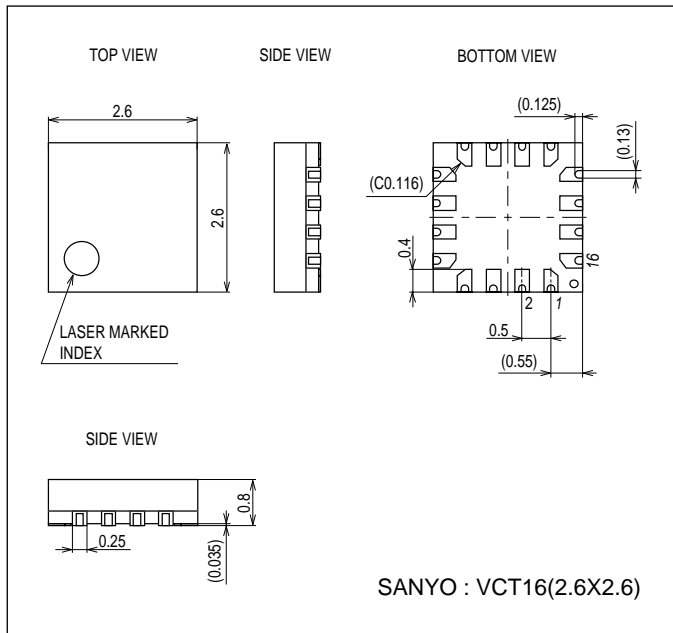

LV5217GP

Block Diagram

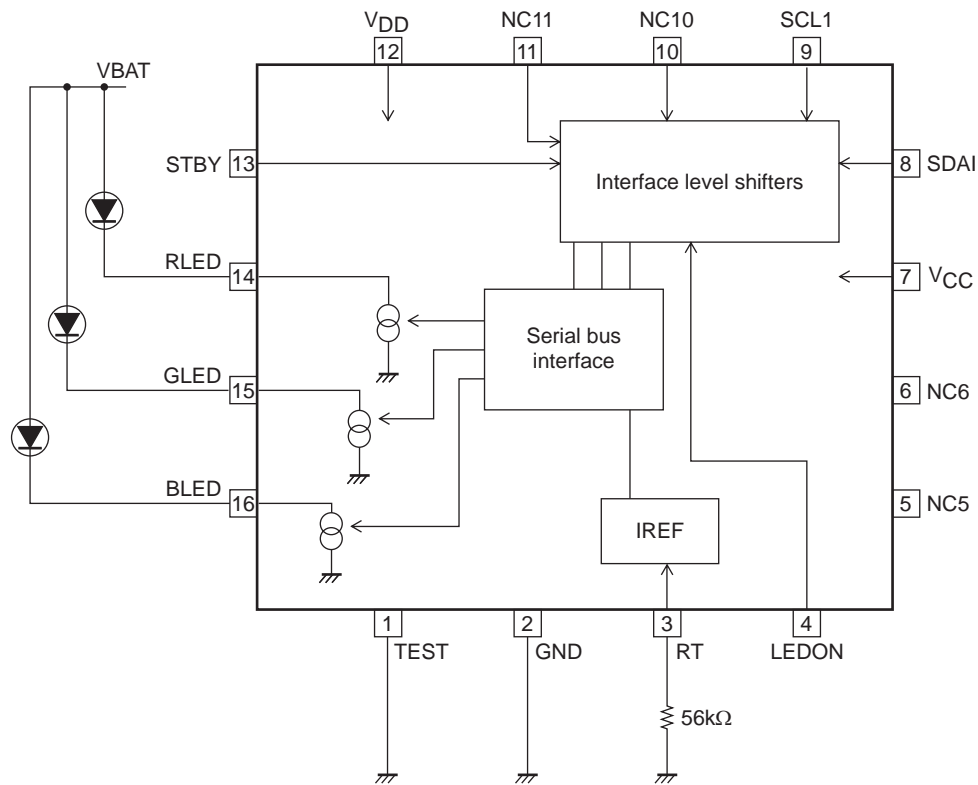

Note 1 : The TEST pin must be tied to ground.

Pin Functions

Pin No.	Pin name	Function
1	TEST	Test signal input: This pin must be connected to ground.
2	GND	Ground
3	RT	Reference current setting resistor connection
4	LEDON	External LED control pin
5	NC5	No connection
6	NC6	No connection
7	VCC	Circuit system power supply
8	SDAI	Serial data signal input
9	SCLI	Serial clock signal input
10	NC10	No connection
11	NC11	No connection
12	VDD	Power supply for logic system
13	STBY	Standby mode control
14	RLED	Red LED driver output
15	GLED	Green LED driver output
16	BLED	Blue LED driver output

LV5217GP

Pin Functions

Pin No.	Symbol	Description	Equivalent circuit
4	LEDON	Control inputs for the three external colored LEDs. When an RSW, GSW, or BSW bit in the serial data is set to 1, the corresponding LED will be on when the voltage applied to the corresponding pin is high, and off when the voltage applied is low.	
8 9	SDAI SCLI	I ² C signal inputs	
3	RT	Reference current setting resistor connection. A reference current is created by connecting an external resistor between this pin and ground. The pin voltage is roughly 1.2V. The LED driver current can be changed by changing this current value.	
14 15 16	RLED GLED BLED	Driver outputs for the three color LEDs. Feedback is applied to control the current flowing in the output transistors to be the set value. Each of the driver output current levels can be set independently with the serial data.	

Continued on next page.

LV5217GP

Continued from preceding page.

Pin No.	Symbol	Description	Equivalent circuit
1	TEST	Test signal input. This pin must be connected to ground.	
13	STBY	Standby mode pin. The LV5217GP goes to standby mode when the STBY pin is at the low level.	
7	V _{CC}	Circuit system power supply	
12	V _{DD}	Power supply for Logic	
3	GND	Ground	

LV5217GP

Power Supply Application

1. Either bring up VCC and VDD at the same time, or bring up VCC first then VDD.
2. Then, set the serial data. (After the serial data has been set, a period of about 2μs is required as the startup time for the IC internal circuits.)
3. Finally, clear the STBY pin states.

Serial Data Map

Register address								Data							
A7	A6	A5	A4	A3	A2	A1	A0	D7	D6	D5	D4	D3	D2	D1	D0
0	0	0	0	0	0	0	0	RSW	R[6:0]						
								0	0	0	0	0	0	0	0
0	0	0	0	0	0	0	1	GSW	G[6:0]						
								0	0	0	0	0	0	0	0
0	0	0	0	0	0	1	0	BSW	B[6:0]						
								0	0	0	0	0	0	0	0

Upper row : Register name, Lower row : default value

Serial Data Mode Settings

R mode

0	0	0	0	0	0	0	0	D7	D6	D5	D4	D3	D2	D1	D0
---	---	---	---	---	---	---	---	----	----	----	----	----	----	----	----

LEDR output setting

D7	RSW
0	OFF (default)
1	ON

G mode

0	0	0	0	0	0	0	1	D7	D6	D5	D4	D3	D2	D1	D0
---	---	---	---	---	---	---	---	----	----	----	----	----	----	----	----

LEDR output setting

D7	GSW
0	OFF (default)
1	ON

B mode

0	0	0	0	0	0	1	0	D7	D6	D5	D4	D3	D2	D1	D0
---	---	---	---	---	---	---	---	----	----	----	----	----	----	----	----

LEDR output setting

D7	BSW
0	OFF (default)
1	ON

LV5217GP

D6-D0 current setting (Common to R, G and B)

D6	D5	D4	D3	D2	D1	D0	Current [mA]
0	0	0	0	0	0	0	0.1 (Default) *1
0	0	0	0	0	0	1	0.31
0	0	0	0	0	1	0	0.52
0	0	0	0	0	1	1	0.72
0	0	0	0	1	0	0	0.93
0	0	0	0	1	0	1	1.13
0	0	0	0	1	1	0	1.34
0	0	0	0	1	1	1	1.54
0	0	0	1	0	0	0	1.74
0	0	0	1	0	0	1	1.94
0	0	0	1	0	1	0	2.14
0	0	0	1	0	1	1	2.34
0	0	0	1	1	0	0	2.54
0	0	0	1	1	0	1	2.74
0	0	0	1	1	1	0	2.95
0	0	0	1	1	1	1	3.15
0	0	1	0	0	0	0	3.35
0	0	1	0	0	0	1	3.46
0	0	1	0	0	1	0	3.76
0	0	1	0	0	1	1	3.97
0	0	1	0	1	0	0	4.17
0	0	1	0	1	0	1	4.37
0	0	1	0	1	1	0	4.57
0	0	1	0	1	1	1	4.76
0	0	1	1	0	0	0	4.97
0	0	1	1	0	1	0	5.17
0	0	1	1	0	1	1	5.37
0	0	1	1	1	0	0	5.57
0	0	1	1	1	0	1	5.78
0	0	1	1	1	1	0	5.98
0	0	1	1	1	1	1	6.18
0	0	1	1	1	1	1	6.39
0	1	0	0	0	0	0	6.60
0	1	0	0	0	0	1	6.80
0	1	0	0	0	1	0	6.99
0	1	0	0	0	1	1	7.19
0	1	0	0	1	0	0	7.39
0	1	0	0	1	0	1	7.60
0	1	0	0	1	1	0	7.80
0	1	0	0	1	1	1	7.99
0	1	0	1	0	0	0	8.19
0	1	0	1	0	0	1	8.40
0	1	0	1	0	1	0	8.60
0	1	0	1	0	1	1	8.80
0	1	0	1	1	0	0	9.00
0	1	0	1	1	0	1	9.20
0	1	0	1	1	1	0	9.40
0	1	0	1	1	1	1	9.60
0	1	1	0	0	0	0	9.80
0	1	1	0	0	0	1	10.00
0	1	1	0	0	1	0	10.20
0	1	1	0	0	1	1	10.40
0	1	1	0	1	0	0	10.60
0	1	1	0	1	0	1	10.80

Continued on next page.

LV5217GP

Continued from preceding page.

D6	D5	D4	D3	D2	D1	D0	Current [mA]
0	1	1	0	1	1	0	11.00
0	1	1	0	1	1	1	11.20
0	1	1	1	0	0	0	11.40
0	1	1	1	0	0	1	11.60
0	1	1	1	0	1	0	11.80
0	1	1	1	0	1	1	12.00
0	1	1	1	1	0	0	12.20
0	1	1	1	1	0	1	12.40
0	1	1	1	1	1	0	12.60
0	1	1	1	1	1	1	12.80
1	0	0	0	0	0	0	12.99
1	0	0	0	0	0	1	13.19
1	0	0	0	0	1	0	13.39
1	0	0	0	0	1	1	13.59
1	0	0	0	1	0	0	13.79
1	0	0	0	1	0	1	13.98
1	0	0	0	1	1	0	14.18
1	0	0	0	1	1	1	14.38
1	0	0	1	0	0	0	14.58
1	0	0	1	0	0	1	14.78
1	0	0	1	0	1	0	14.97
1	0	0	1	0	1	1	15.17
1	0	0	1	1	0	0	15.37
1	0	0	1	1	0	1	15.57
1	0	0	1	1	1	0	15.77
1	0	0	1	1	1	1	15.96
1	0	1	0	0	0	0	16.16
1	0	1	0	0	0	1	16.36
1	0	1	0	0	1	0	16.56
1	0	1	0	0	1	1	16.76
1	0	1	0	1	0	0	16.96
1	0	1	0	1	0	1	17.15
1	0	1	0	1	1	0	17.35
1	0	1	0	1	1	1	17.55
1	0	1	1	0	0	0	17.75
1	0	1	1	0	0	1	17.95
1	0	1	1	0	1	0	18.15
1	0	1	1	0	1	1	18.34
1	0	1	1	1	0	0	18.54
1	0	1	1	1	0	1	18.74
1	0	1	1	1	1	0	18.94
1	0	1	1	1	1	1	19.14
1	1	0	0	0	0	0	19.33
1	1	0	0	0	0	1	19.53
1	1	0	0	0	1	0	19.73
1	1	0	0	0	1	1	19.93
1	1	0	0	1	0	0	20.13
1	1	0	0	1	0	1	20.32
1	1	0	0	1	1	0	20.52
1	1	0	0	1	1	1	20.72
1	1	0	1	0	0	0	20.92
1	1	0	1	0	0	1	21.12
1	1	0	1	0	1	0	21.31
1	1	0	1	0	1	1	21.51
1	1	0	1	1	0	0	21.71

Continued on next page.

LV5217GP

Continued from preceding page.

D6	D5	D4	D3	D2	D1	D0	Current [mA]
1	1	0	1	1	0	1	21.91
1	1	0	1	1	1	0	22.11
1	1	0	1	1	1	1	22.30
1	1	1	0	0	0	0	22.50
1	1	1	0	0	0	1	22.70
1	1	1	0	0	1	0	22.90
1	1	1	0	0	1	1	23.10
1	1	1	0	1	0	0	23.29
1	1	1	0	1	0	1	23.49
1	1	1	0	1	1	0	23.69
1	1	1	0	1	1	1	23.89
1	1	1	1	0	0	0	24.09
1	1	1	1	0	0	1	24.29
1	1	1	1	0	1	0	24.48
1	1	1	1	0	1	1	24.68
1	1	1	1	1	0	0	24.88
1	1	1	1	1	0	1	25.08
1	1	1	1	1	1	0	25.28
1	1	1	1	1	1	1	25.48

* Note 1 : There is significant current variance, so care should be taken for use. The current value can be set when D7 is "0."

Serial Bus Communication Specifications

I²C serial transfer timing conditions

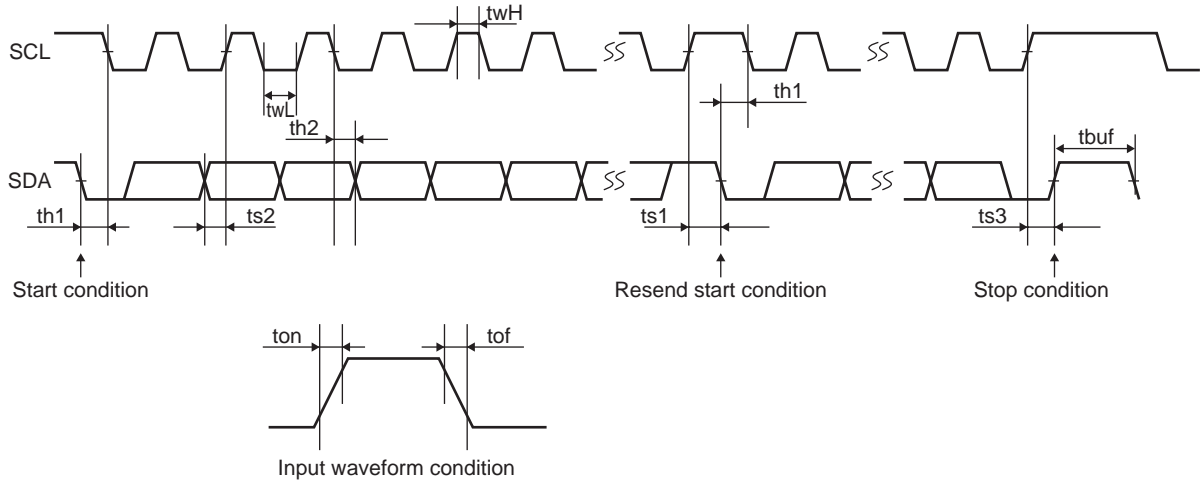

Standard mode

Parameter	symbol	Conditions	min	typ	max	unit
SCL clock frequency	fscl	SCL clock frequency	0		100	kHz
Data setup time	ts1	The SCL setup time from the SDA rising edge	4.7			μs
	ts2	The SDA setup time from the SCL rising edge	250			ns
	ts3	The SCL setup time from the SDA rising edge	4.0			μs
Data hold time	th1	The SCL hold time from the SDA falling edge	4.0			μs
	th2	The SDA hold time from the SCL falling edge	0			μs
Pulse width	twL	SCL low period pulse width	4.7			μs
	twH	SCL high period pulse width	4.0			μs
Input waveform conditions	ton	SCL, SDA (input) rising time			1000	ns
	tof	SCL, SDA (input) falling time			300	ns
Bus free time	tbuf	Time between STOP and TART conditions	4.7			μs

High-speed mode

Parameter	Symbol	Conditions	min	typ	max	unit
SCL clock frequency	fscl	SCL clock frequency	0		400	kHz
Data setup time	ts1	The SCL setup time from the SDA rising edge	0.6			μs
	ts2	The SDA setup time from the SCL rising edge	100			ns
	ts3	The SCL setup time from the SDA rising edge	0.6			μs
Data hold time	th1	The SCL hold time from the SDA falling edge	0.6			μs
	th2	The SDA hold time from the SCL falling edge	0			μs
Pulse width	twL	SCL low period pulse width	1.3			μs
	twH	SCL high period pulse width	0.6			μs
Input waveform conditions	ton	SCL, SDA (input) rising time			300	ns
	tof	SCL, SDA (input) falling time			300	ns
Bus free time	tbuf	Time between STOP condition and TART condition	1.3			μs

LV5217GP

I²C bus transmission method

START condition and STOP condition

When transferring data over an I²C bus, SDA must basically be held in certain states while SCL is High, as shown in the figure below.

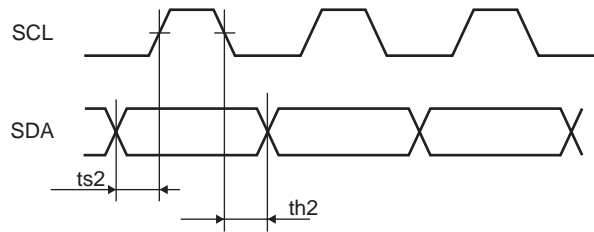

Both SCL and SDA are high when not performing data transfer.

When both SCL and SDA are high, changing SDA from high to low generates the START condition and starts access.

Changing SDA from low to high while SCL is high generates the STOP condition and ends access.

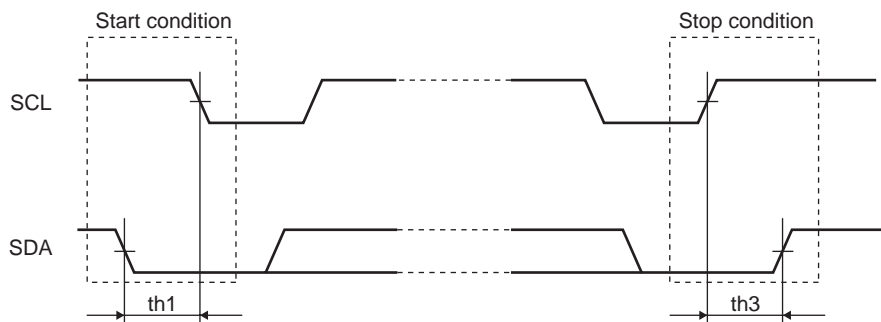

Data transfer and confirmation response

After the START condition is generated, data is transferred one byte (8 bits) at a time. Data can be transferred continuously for any number of bytes. The ACK signal is sent from the receiving to the transmitting side each time 8 bits of data are transferred.

The transmitting side releases the SDA line immediately after the SCL clock pulse corresponding to the 8th data transfer bit as it falls to Low, and the receiving side then sends the ACK signal by setting SDA Low.

After the receiving side sends the ACK signal, if the next byte transfer is still in receive mode, the receiving side releases the SDA line at the falling edge of the 9th SCL clock.

The I²C bus does not have a CE signal, so instead a 7-bit slave address is assigned to each device. The first byte of each transfer is assigned to this 7-bit slave address and a command (R/W) indicating the transfer direction of the following data. Note that only Write mode is valid for this IC.

The 7-bit address is transferred in order from the MSB, and the 8th bit is Low to indicate Write mode.

The LV5217GP slave address is prescribed as "1110101."

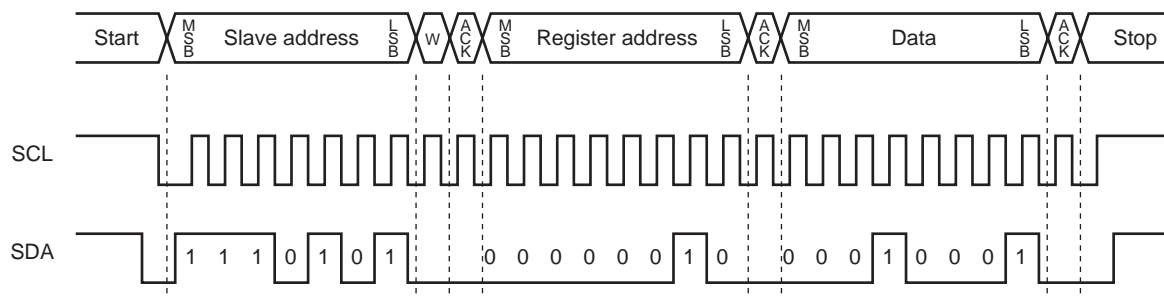

- SANYO Semiconductor Co.,Ltd. assumes no responsibility for equipment failures that result from using products at values that exceed, even momentarily, rated values (such as maximum ratings, operating condition ranges, or other parameters) listed in products specifications of any and all SANYO Semiconductor Co.,Ltd. products described or contained herein.
- SANYO Semiconductor Co.,Ltd. strives to supply high-quality high-reliability products, however, any and all semiconductor products fail or malfunction with some probability. It is possible that these probabilistic failures or malfunction could give rise to accidents or events that could endanger human lives, trouble that could give rise to smoke or fire, or accidents that could cause damage to other property. When designing equipment, adopt safety measures so that these kinds of accidents or events cannot occur. Such measures include but are not limited to protective circuits and error prevention circuits for safe design, redundant design, and structural design.
- In the event that any or all SANYO Semiconductor Co.,Ltd. products described or contained herein are controlled under any of applicable local export control laws and regulations, such products may require the export license from the authorities concerned in accordance with the above law.
- No part of this publication may be reproduced or transmitted in any form or by any means, electronic or mechanical, including photocopying and recording, or any information storage or retrieval system, or otherwise, without the prior written consent of SANYO Semiconductor Co.,Ltd.
- Any and all information described or contained herein are subject to change without notice due to product/technology improvement, etc. When designing equipment, refer to the "Delivery Specification" for the SANYO Semiconductor Co.,Ltd. product that you intend to use.
- Information (including circuit diagrams and circuit parameters) herein is for example only; it is not guaranteed for volume production.
- Upon using the technical information or products described herein, neither warranty nor license shall be granted with regard to intellectual property rights or any other rights of SANYO Semiconductor Co.,Ltd. or any third party. SANYO Semiconductor Co.,Ltd. shall not be liable for any claim or suits with regard to a third party's intellectual property rights which has resulted from the use of the technical information and products mentioned above.

This catalog provides information as of October, 2010. Specifications and information herein are subject to change without notice.