

Hyper 5 mm (T1 3/4) LED, Non Diffused Hyper-Bright LED

LB 5433, LV 5433, LT 5433



Vorläufige Daten / Preliminary Data

Besondere Merkmale

- **Gehäusetyp:** klares 5 mm (T1 3/4) Gehäuse
- **Besonderheit des Bauteils:** enge Abstrahlcharakteristik
- **Wellenlänge:** 470 nm (blau), 505 nm (verde), 528 nm (true green)
- **Abstrahlwinkel:** 40°
- **Technologie:** InGaN
- **optischer Wirkungsgrad:** 2 lm/W (blau), 6 lm/W (verde), 8 lm/W (true green)
- **Gruppierungsparameter:** Lichtstärke
- **Lötmethode:** Wellenlöten (TTW)
- **Verpackung:** Schüttgut, gegurtet lieferbar
- **ESD-Festigkeit:** ESD-sicher bis 2 kV nach MIL STD 883 D, Method 3015,7

Anwendungen

- Informationsanzeigen im Außenbereich
- optischer Indikator
- Hinterleuchtung (Tasten, Displays, Werbebeleuchtung, Allgemeinbeleuchtung)
- Innenbeleuchtung im Automobilbereich (z.B. Instrumentenbeleuchtung, u. ä.)
- Ersatz von Kleinst-Glühlampen
- Signal- und Symbolleuchten
- Markierungsbeleuchtung (z.B. Stufen, Fluchtwege, u.ä.)

Features

- **package:** clear 5 mm (T1 3/4) package
- **feature of the device:** narrow viewing angle
- **wavelength:** 470 nm (blue), 505 nm (verde), 528 nm (true green)
- **viewing angle:** 40°
- **technology:** InGaN
- **optical efficiency:** 2 lm/W (blue), 6 lm/W (verde), 8 lm/W (true green)
- **grouping parameter:** luminous intensity
- **soldering methods:** TTW soldering
- **packing:** bulk, available taped on reel
- **ESD-withstand voltage:** up to 2 kV acc. to MIL STD 883 D, Method 3015.7

Applications

- outdoor displays
- optical indicators
- backlighting (keys, displays, illuminated advertising, general lighting)
- interior automotive lighting (e.g. dashboard backlighting, etc.)
- substitution of micro incandescent lamps
- signal and symbol luminaire
- marker lights (e.g. steps, exit ways, etc.)

Typ Type	Emissions- farbe Color of Emission	Gehäusefarbe Color of Package	Lichtstärke Luminous Intensity $I_F = 20 \text{ mA}$ $I_V \text{ (mcd)}$	Lichtstrom Luminous Flux $I_F = 20 \text{ mA}$ $\Phi_V \text{ (lm)}$	Bestellnummer Ordering Code
LB 5433-QS LB 5433-SU LB 5433-Q LB 5433-R LB 5433-S LB 5433-T LB 5433-U	blue	colorless clear	71 ... 280 180 ... 710 71 ... 112 112 ... 180 180 ... 280 280 ... 450 450 ... 710	120 (typ.) 300 (typ.) 60 (typ.) 90 (typ.) 150 (typ.) 230 (typ.) 380 (typ.)	Q62703-Q4843
LV 5433-TV LV 5433-VBW LV 5433-T LV 5433-U LV 5433-V LV 5433-AW LV 5433-BW	verde	colorless clear	280 ... 1120 710 ... 2800 280 ... 450 450 ... 710 710 ... 1120 1120 ... 1800 1800 ... 2800	470 (typ.) 1000 (typ.) 230 (typ.) 380 (typ.) 590 (typ.) 940 (typ.) 1500 (typ.)	Q62703-Q4850
LT 5433-TV LT 5433-VBW LT 5433-T LT 5433-U LT 5433-V LT 5433-AW LT 5433-BW	true green	colorless clear	280 ... 1120 710 ... 2800 280 ... 450 450 ... 710 710 ... 1120 1120 ... 1800 1800 ... 2800	470 (typ.) 1000 (typ.) 230 (typ.) 380 (typ.) 590 (typ.) 940 (typ.) 1500 (typ.)	Q62703-Q4857

Helligkeitswerte werden mit einer Stromeinprägedauer von 25 ms und einer Genauigkeit von $\pm 11 \%$ ermittelt.

Luminous intensity is tested at a current pulse duration of 25 ms and an accuracy of $\pm 11 \%$.

Grenzwerte
Maximum Ratings

Bezeichnung Parameter	Symbol Symbol	Wert Value		Einheit Unit
		LB	LV, LT	
Betriebstemperatur Operating temperature range	T_{op}	- 55 ... + 100		°C
Lagertemperatur Storage temperature range	T_{stg}	- 55 ... + 100		°C
Sperrschichttemperatur Junction temperature	T_j	+ 100		°C
Durchlassstrom Forward current	I_F	20		mA
Stoßstrom Surge current $t \leq 10 \mu s, D = 0.005$	I_{FM}	200	250	mA
Sperrspannung Reverse voltage	V_R	5		V
Leistungsaufnahme Power dissipation $T_A \leq 25 \text{ °C}$	P_{tot}	85		mW
Wärmewiderstand Thermal resistance Sperrschicht/Umgebung Junction/ambient	$R_{th JA}$	400		K/W
Sperrschicht/Löt看 Junction/solder point Montage auf PC-Board FR 4 (Padgröße $\geq 16 \text{ mm}^2$) mounted on PC board FR 4 (pad size $\geq 16 \text{ mm}^2$) Minimale Beinchenlänge Minimum lead length	$R_{th JS}$	180		K/W

Kennwerte ($T_A = 25\text{ °C}$)

Characteristics

Bezeichnung Parameter	Symbol Symbol	Werte Values			Einheit Unit
		LB	LV	LT	
Wellenlänge des emittierten Lichtes Wavelength at peak emission $I_F = 20\text{ mA}$	(typ.) λ_{peak}	465	503	523	nm
Dominantwellenlänge ¹⁾ Dominant wavelength ¹⁾ $I_F = 20\text{ mA}$	(typ.) λ_{dom}	470 ± 6	505 ± 7	528 ± 9	nm
Spektrale Bandbreite bei 50 % $I_{\text{rel max}}$ Spectral bandwidth at 50 % $I_{\text{rel max}}$ $I_F = 20\text{ mA}$	(typ.) $\Delta\lambda$	25	30	33	nm
Abstrahlwinkel bei 50 % I_V (Vollwinkel) Viewing angle at 50 % I_V	(typ.) 2ϕ	40	40	40	Grad deg.
Durchlassspannung Forward voltage $I_F = 20\text{ mA}$	(typ.) V_F (max.) V_F	3.5 4.2	3.3 4.2	3.3 4.2	V V
Sperrstrom Reverse current $V_R = 5\text{ V}$	(typ.) I_R (max.) I_R	0.01 10	0.01 10	0.01 10	μA μA
Temperaturkoeffizient von λ_{peak} Temperature coefficient of λ_{peak} $I_F = 20\text{ mA}$	(typ.) $TC_{\lambda_{\text{peak}}}$	0.04	0.03	0.04	nm/K
Temperaturkoeffizient von λ_{dom} Temperature coefficient of λ_{dom} $I_F = 20\text{ mA}$	(typ.) $TC_{\lambda_{\text{dom}}}$	0.02	0.02	0.03	nm/K
Temperaturkoeffizient von V_F Temperature coefficient of V_F $I_F = 20\text{ mA}$	(typ.) TC_V	- 2.9	- 3.2	- 3.6	mV/K
Optischer Wirkungsgrad Optical efficiency $I_F = 20\text{ mA}$	(typ.) η_{opt}	2	6	8	lm/W

1) Wellenlängengruppen / Wavelength groups

Gruppe Group	blue		verde		true green	
	min.	max.	min.	max.	min.	max.
3	464	468	498	503	519	525
4	468	472	503	507	525	531
5	472	476	507	512	531	537

Wellenlängengruppen werden mit einer Stromeinprägedauer von 25 ms und einer Genauigkeit von ± 1 nm ermittelt.

Wavelength groups are tested at a current pulse duration of 25 ms and an accuracy of ± 1 nm.

Relative spektrale Emission $I_{rel} = f(\lambda)$, $T_A = 25\text{ °C}$, $I_F = 20\text{ mA}$

Relative Spectral Emission

$V(\lambda)$ = spektrale Augenempfindlichkeit

Standard eye response curve

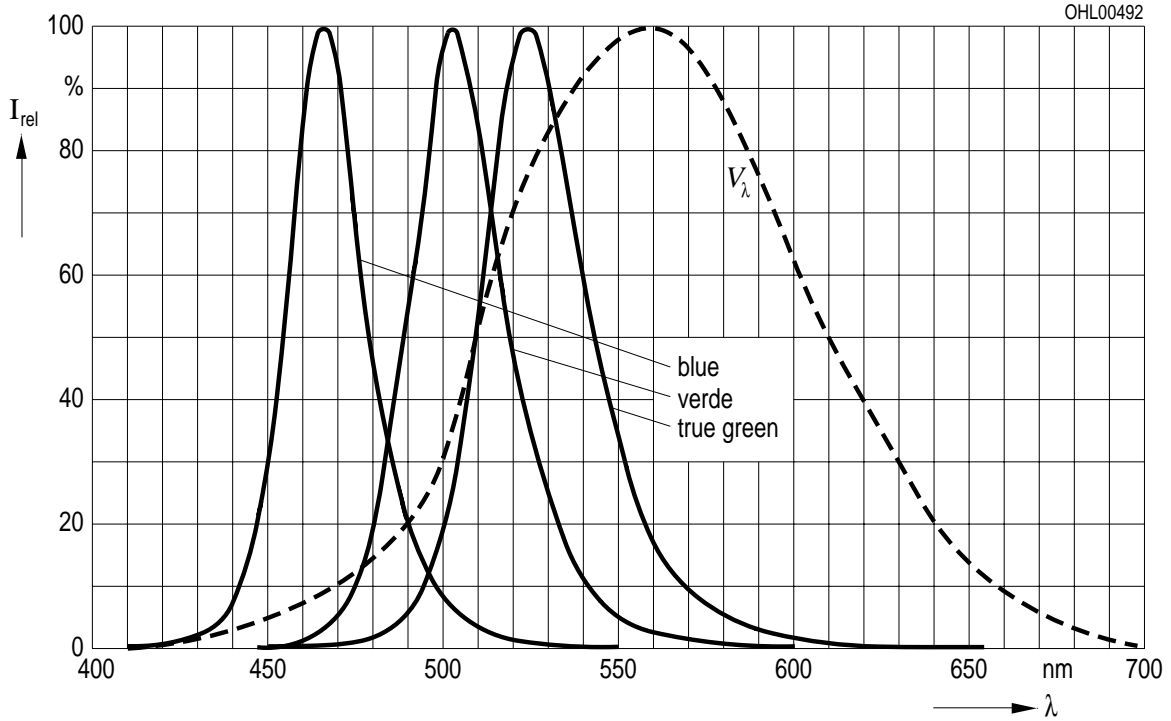

Abstrahlcharakteristik $I_{rel} = f(\varphi)$

Radiation Characteristic

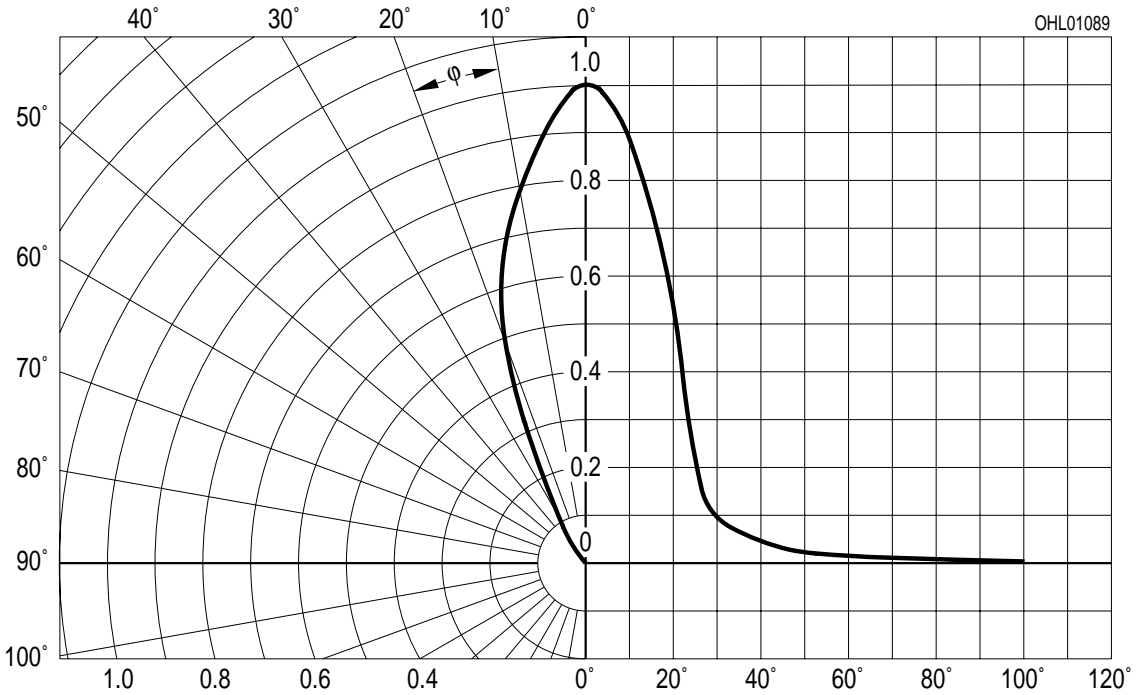

Durchlassstrom $I_F = f(V_F)$

Forward Current

$T_A = 25\text{ °C}$

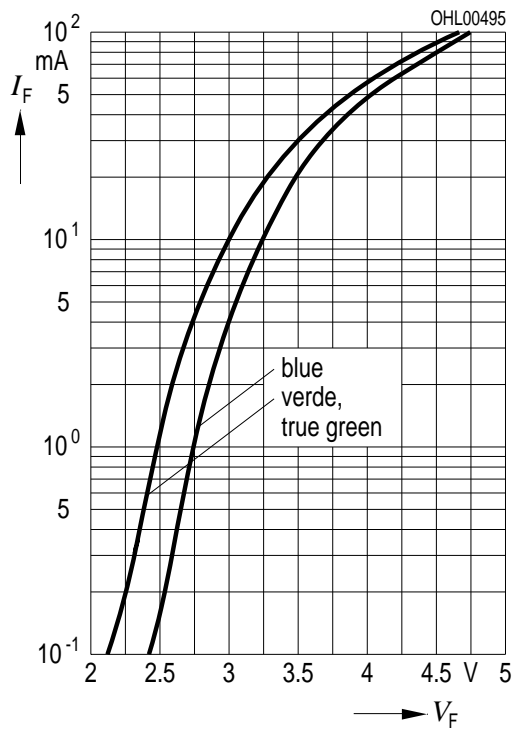

Relative Lichtstärke $I_V/I_{V(20\text{ mA})} = f(I_F)$

Relative Luminous Intensity

$T_A = 25\text{ °C}$

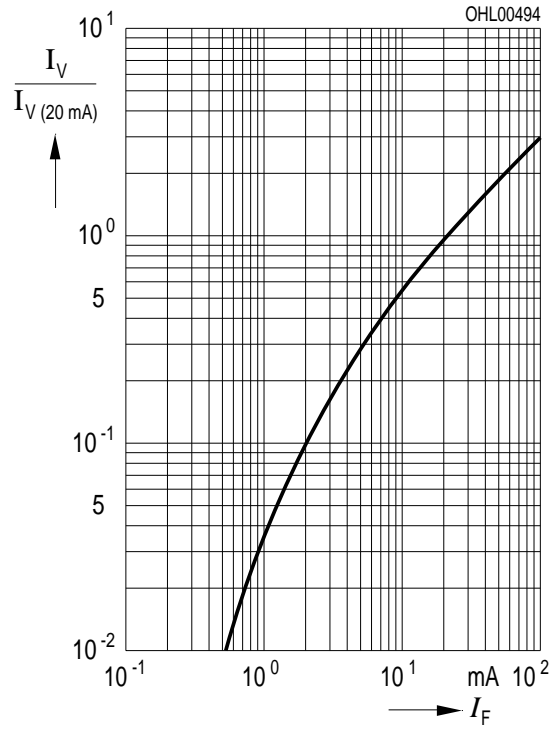

Maximal zulässiger Durchlassstrom $I_F = f(T)$

Max. Permissible Forward Current

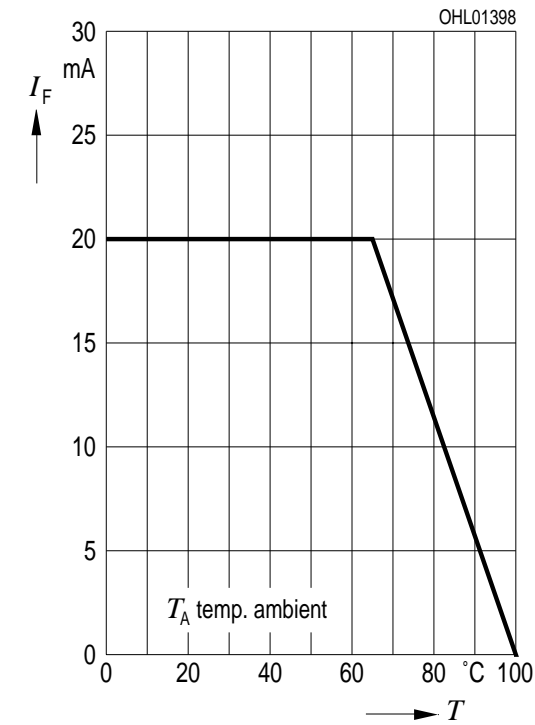

Maximal zulässiger Durchlassstrom $I_F = f(T)$

Max. Permissible Forward Current

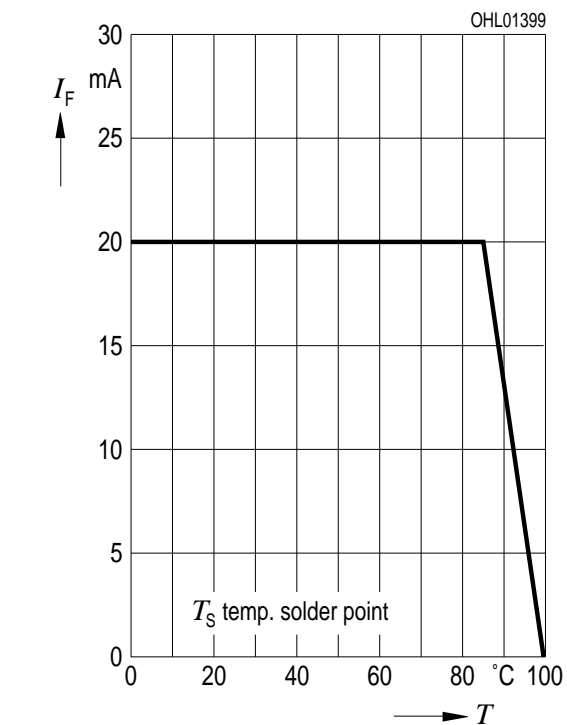

Relative Lichtstärke $I_V/I_{V(25^\circ\text{C})} = f(T_A)$
Relative Luminous Intensity
 $I_F = 20 \text{ mA}$

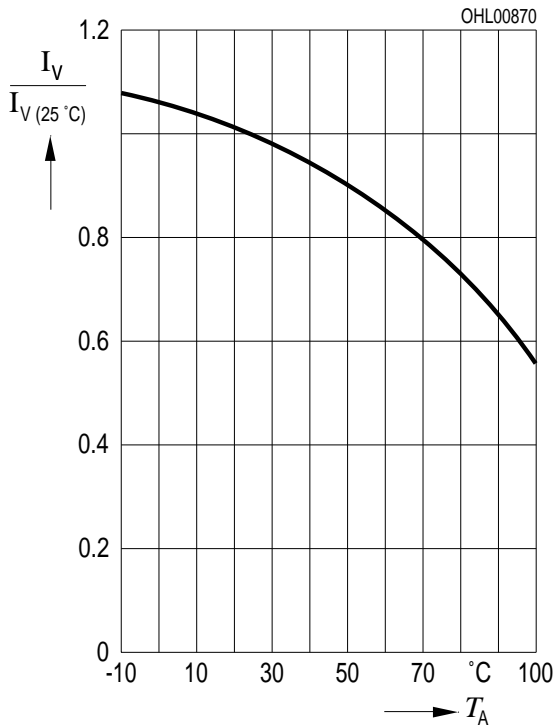

Dominante Wellenlänge $\lambda_{\text{dom}} = f(I_F)$
Dominant Wavelength
LB, $T_A = 25^\circ\text{C}$

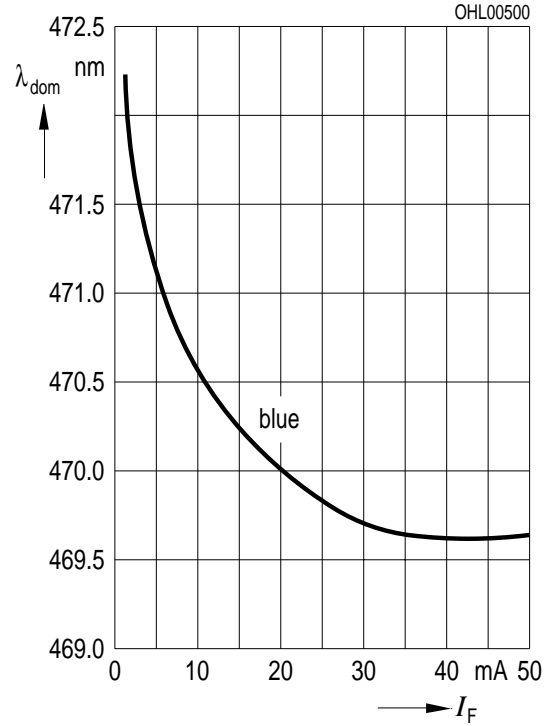

Dominante Wellenlänge $\lambda_{\text{dom}} = f(I_F)$
Dominant Wavelength
LV, $T_A = 25^\circ\text{C}$

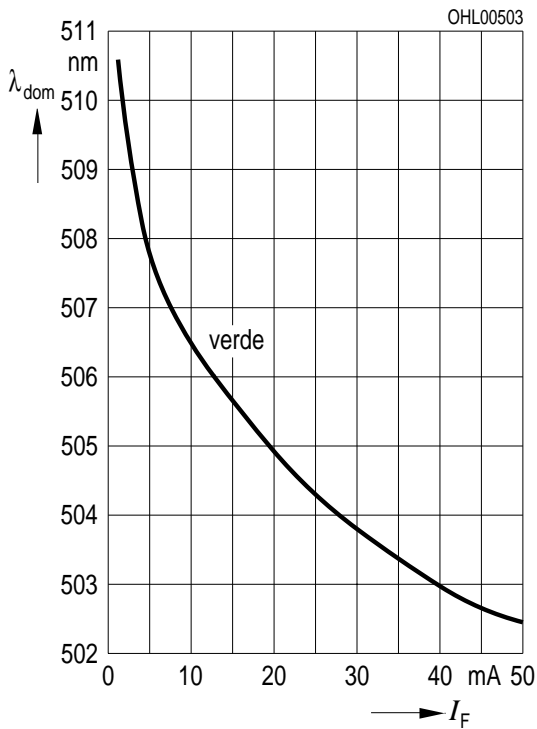

Dominante Wellenlänge $\lambda_{\text{dom}} = f(I_F)$
Dominant Wavelength
LT, $T_A = 25^\circ\text{C}$

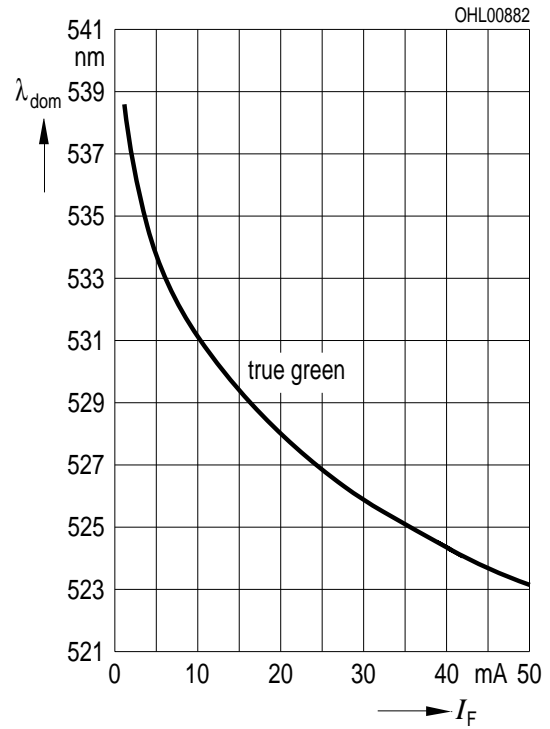

Zulässige Impulsbelastbarkeit $I_F = f(t_p)$
Permissible Pulse Handling Capability
 Duty cycle $D =$ parameter, $T_A = 25\text{ °C}$
LB

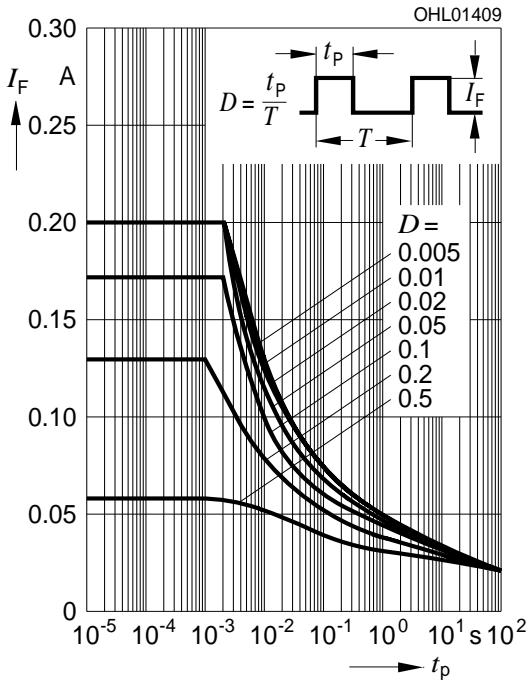

Zulässige Impulsbelastbarkeit $I_F = f(t_p)$
Permissible Pulse Handling Capability
 Duty cycle $D =$ parameter, $T_A = 85\text{ °C}$
LB

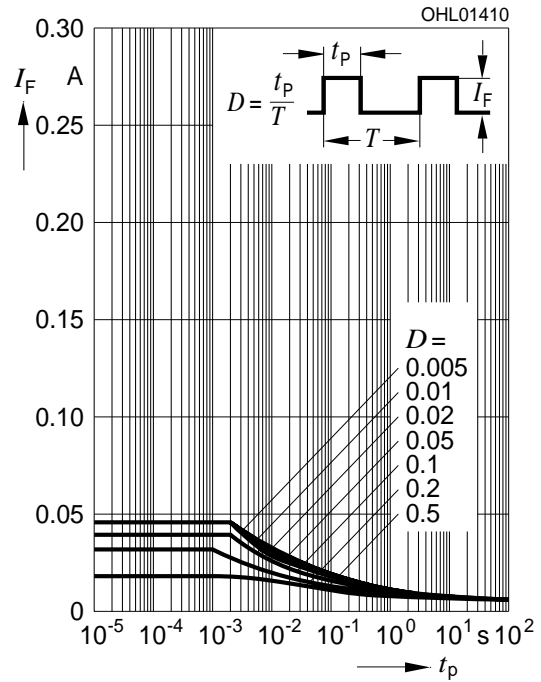

Zulässige Impulsbelastbarkeit $I_F = f(t_p)$
Permissible Pulse Handling Capability
 Duty cycle $D =$ parameter, $T_A = 25\text{ °C}$
LV, LT

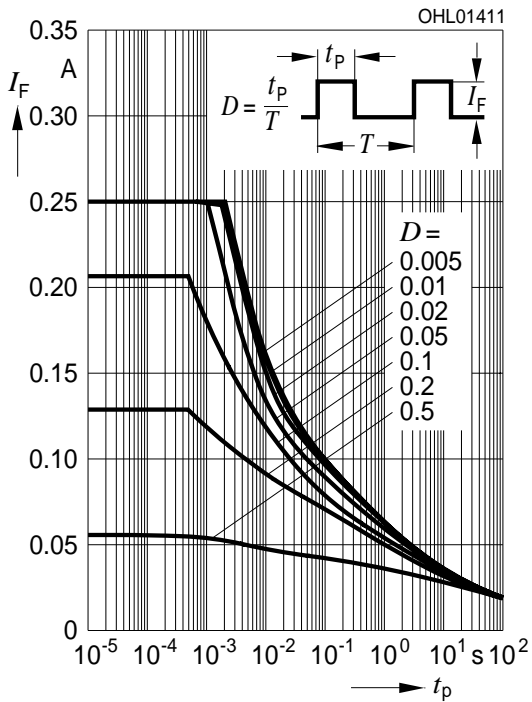

Zulässige Impulsbelastbarkeit $I_F = f(t_p)$
Permissible Pulse Handling Capability
 Duty cycle $D =$ parameter, $T_A = 85\text{ °C}$
LV, LT

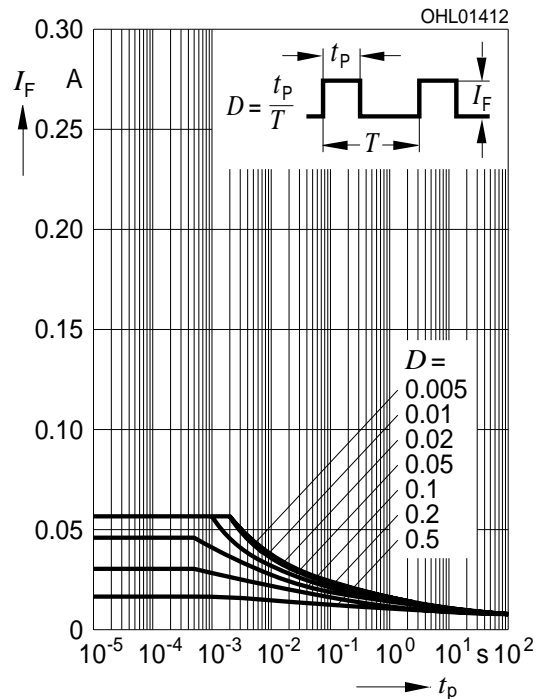

**Maßzeichnung
Package Outlines**

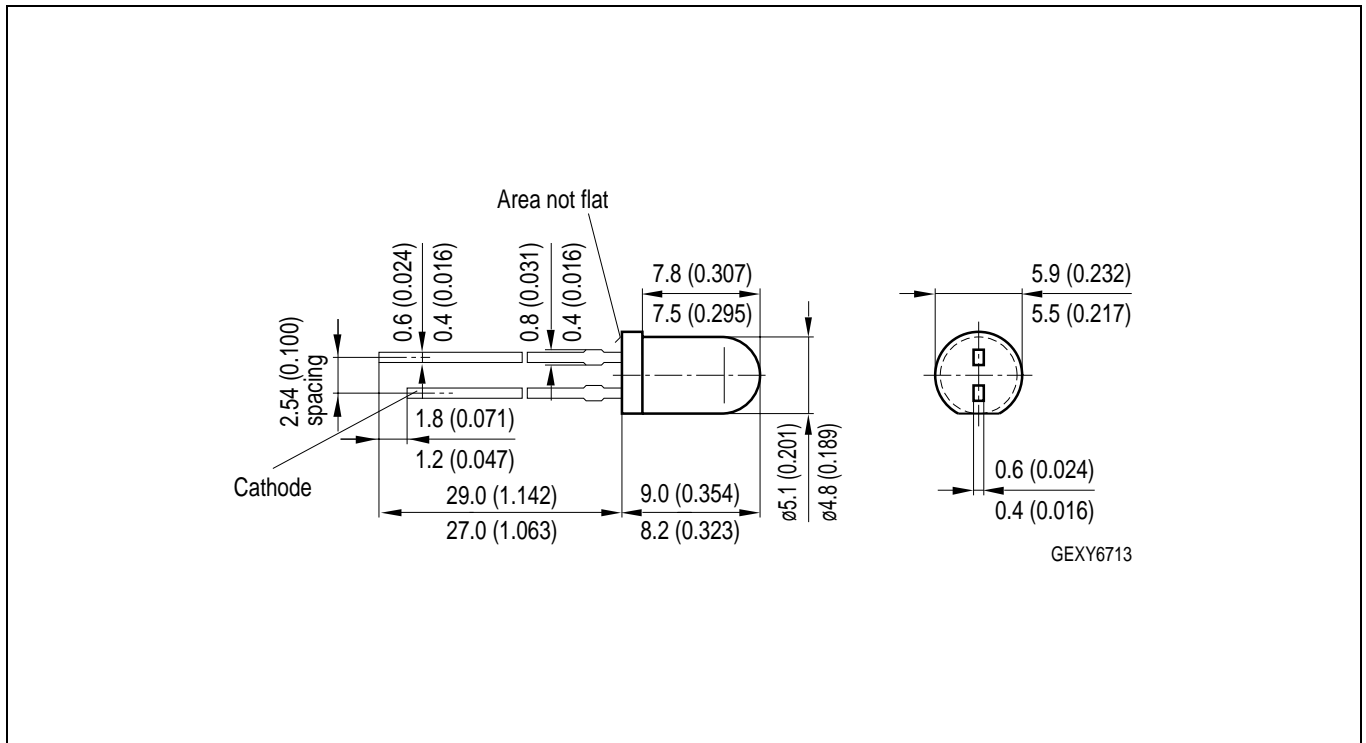

Maße werden wie folgt angegeben: mm (inch) / Dimensions are specified as follows: mm (inch).

Kathodenkennung: kürzerer Lötspieß
Cathode mark: short solder lead
Gewicht / Approx. weight: 0.35 g

Lötbedingungen
Soldering Conditions

Wellenlöten (TTW)(nach CECC 00802)
TTW Soldering(acc. to CECC 00802)

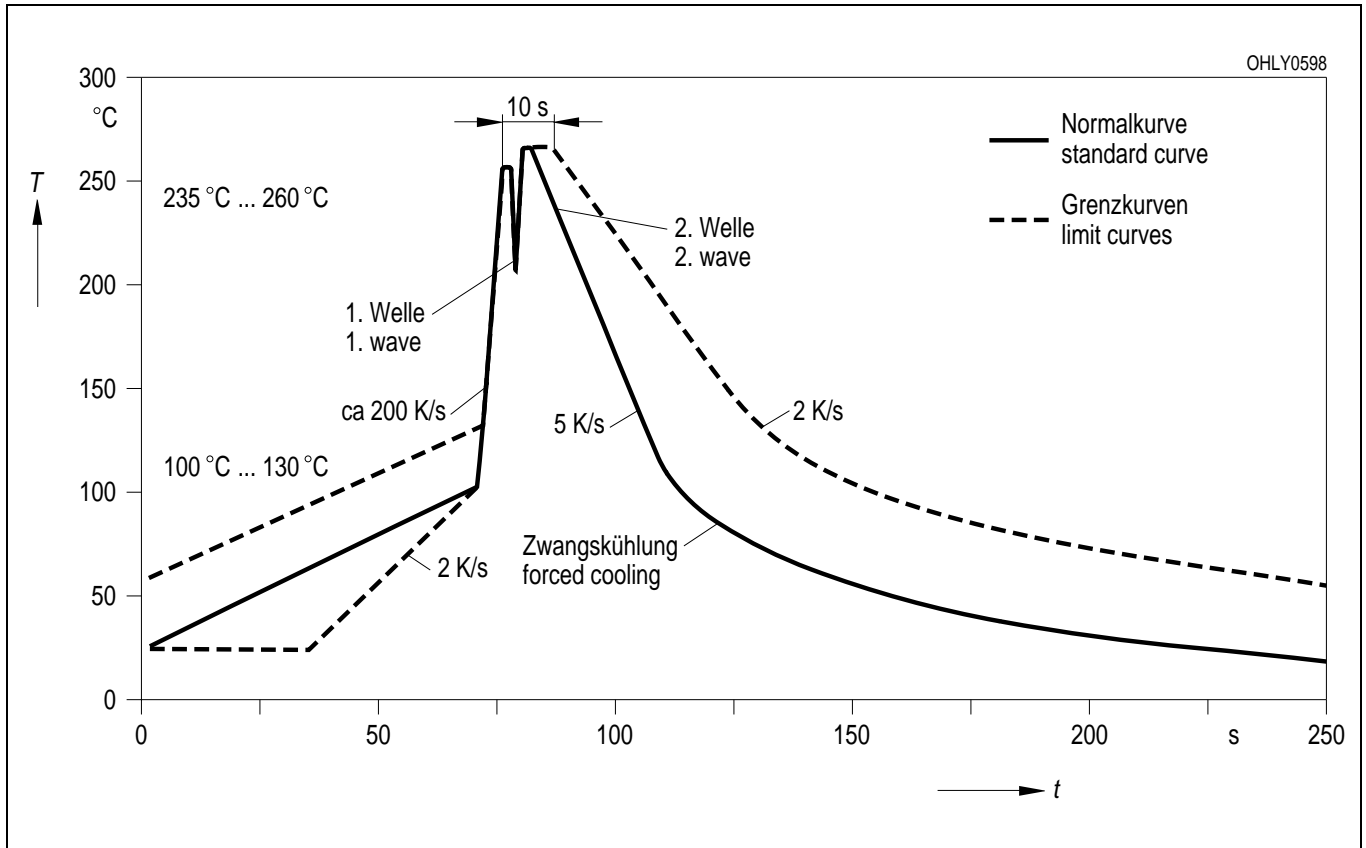

Empfohlenes Lötpaddesign Wellenlöten (TTW)
Recommended Solder Pad TTW Soldering

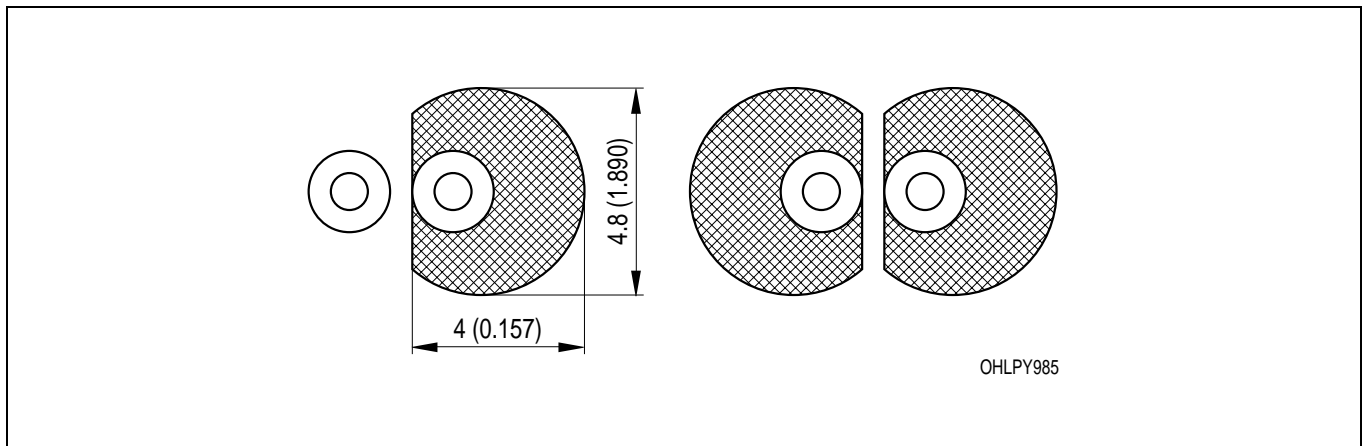

Maße werden wie folgt angegeben: mm (inch) / Dimensions are specified as follows: mm (inch).