



SANYO Semiconductors

DATA SHEET

An ON Semiconductor Company

LV5813TT — Bi-CMOS IC Step-down Switching Regulator

Overview

LV5813TT is 1ch step down switching regulator. 0.25Ω FET is incorporated on the upper side to achieve high-efficiency operation for large output current. Compact-package MSOP8 (150mil) employed. Current mode control type, with superior load current response and easy phase compensation. ON/OFF pin, allowing the standby mode with the current drain of 90μA or less. Pulse-by-pulse over-current protection and overheat protection available for protection of load devices. Soft start pin to be provided with a capacitance for soft start.

Functions

- 1.5A 1ch step-down switching regulator
- Wide input dynamic range (4.75V to 18V)
- High efficiency : 90% ($V_{IN} = 12V$, $V_{OUT} = 5V$, $I_{OUT} = 1A$)
- Compact package : MSOP8 (150mil)
- Standby mode
- Over-current protection
- Thermal shutdown
- Fixed frequency : 370kHz
- Soft start
- Reference voltage : 0.8V

Applications

- LCD TV
- Blu-ray Disc Player/Recorder
- Pre regulator
- PDP TV
- For χDSL power supply
- Amusement

■ Any and all SANYO Semiconductor Co.,Ltd. products described or contained herein are, with regard to "standard application", intended for the use as general electronics equipment (home appliances, AV equipment, communication device, office equipment, industrial equipment etc.). The products mentioned herein shall not be intended for use for any "special application" (medical equipment whose purpose is to sustain life, aerospace instrument, nuclear control device, burning appliances, transportation machine, traffic signal system, safety equipment etc.) that shall require extremely high level of reliability and can directly threaten human lives in case of failure or malfunction of the product or may cause harm to human bodies, nor shall they grant any guarantee thereof. If you should intend to use our products for applications outside the standard applications of our customer who is considering such use and/or outside the scope of our intended standard applications, please consult with us prior to the intended use. If there is no consultation or inquiry before the intended use, our customer shall be solely responsible for the use.

■ Specifications of any and all SANYO Semiconductor Co.,Ltd. products described or contained herein stipulate the performance, characteristics, and functions of the described products in the independent state, and are not guarantees of the performance, characteristics, and functions of the described products as mounted in the customer's products or equipment. To verify symptoms and states that cannot be evaluated in an independent device, the customer should always evaluate and test devices mounted in the customer's products or equipment.

SANYO Semiconductor Co., Ltd.

<http://semicon.sanyo.com/en/network>

LV5813TT

Specifications

Absolute Maximum Ratings at $T_a = 25^\circ\text{C}$

Parameter	Symbol	Conditions	Ratings	Unit
Maximum input V_{IN} voltage	$V_{IN\ max}$		20	V
BOOT pin maximum voltage	$V_{BT\ max}$		25	V
SW pin maximum voltage	$V_{SW\ max}$		$V_{IN\ max}$	V
BOOT pin-SW pin maximum voltage	$V_{BS-SW\ max}$		7	V
EN pin maximum voltage	$V_{EN\ max}$	*1	$V_{IN}+0.3$	V
FB, COMP, SS pin maximum voltage	$V_{fs\ max}$		7	V
Allowable power dissipation	$P_d\ max$	With specified substrate *2	0.85	W
Junction temperature	$T_J\ max$		150	$^\circ\text{C}$
Operating temperature	T_{opr}		-20 to +80	$^\circ\text{C}$
Storage temperature	T_{stg}		-40 to +150	$^\circ\text{C}$

Note : Plan the maximum voltage while including coil and surge voltages, so that the maximum voltage is not exceeded even for an instant.

*1 : $V_{IN} + 0.3 < V_{IN\ max}$

*2 : Specified substrate : 46.4mm × 31.8mm × 1.7mm, glass epoxy substrate

Recommended Operating Conditions at $T_a = 25^\circ\text{C}$

Parameter	Symbol	Conditions	Ratings	Unit
V_{IN} pin voltage	V_{IN}		4.75 to 18	V
BOOT pin voltage	V_{BT}		-0.3 to 23	V
SW pin voltage	V_{SW}		-0.4 to V_{IN}	V
BOOT pin-SW pin maximum voltage	V_{BS-SW}		6.5	V
EN pin maximum voltage	V_{EN}		$V_{IN} + 0.3$	V
FB, COMP, SS pin voltage	V_{FSO}		6	V

Electrical Characteristics at $T_a = 25^\circ\text{C}$, $V_{IN} = 12\text{V}$, unless otherwise specified.

Parameter	Symbol	Conditions	Ratings			Unit
			min	typ	max	
IC current drain at standby	I_{CC1}	EN = 0V		90		μA
IC current drain in operation	I_{CC2}	EN = 5V, FB = 1V		2		mA
Efficiency	Effcy	$V_{IN} = 12\text{V}$, $I_{OUT} = 1\text{A}$, $V_O = 5\text{V}$, Design target *3		90		%
Reference voltage	V_{ref}	$V_{IN} = 4.75\text{V}$ to 18V	-2%	0.8	+2%	V
FB pin bias current	I_{ref}	FB = 0.8V		20	200	nA
High-side ON resistance	R_{onH}	BOOT = 5V		0.25		Ω
Oscillation frequency	F_{OSC}		296	370	444	kHz
Oscillation frequency during short-circuit protection	F_{OSCS}		85	115	145	kHz
EN high-threshold voltage	V_{enh}		0.9	1.8	2.7	V
EN low-threshold voltage	V_{enl}		0.7	1.35	2.0	V
Maximum ON DUTY	$D\ max$			85		%
Current limit peak value 1	I_{cl1}	$V_{IN} = 12\text{V}$, $V_{OUT} = 1.2\text{V}$, $L = 10\mu\text{H}$	3.1		5.7	A
Current limit peak value 2	I_{cl2}	$V_{IN} = 12\text{V}$, $V_{OUT} = 3.3\text{V}$, $L = 10\mu\text{H}$	2.8		5.4	A
Current limit peak value 3	I_{cl3}	$V_{IN} = 12\text{V}$, $V_{OUT} = 5\text{V}$, $L = 10\mu\text{H}$	2.5		5.1	A
Thermal shutdown temperature	T_{sd}	Design guarantee *4		160		$^\circ\text{C}$
Thermal shutdown temperature hysteresis	D_{tsd}	Design guarantee *4		40		$^\circ\text{C}$
Soft start current	I_{SS}	SS = 0V	3	5	7	μA

*3 : Reference value (not tested before shipment)

*4 : Design guarantee (value guaranteed by design and not tested before shipment)

LV5813TT

Package Dimensions

unit : mm (typ)
3245B

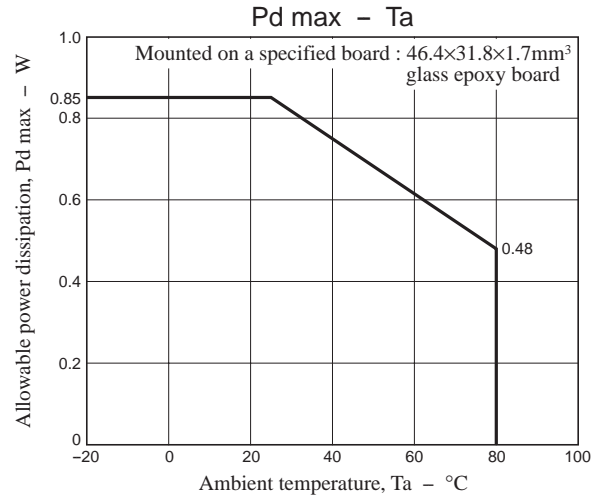
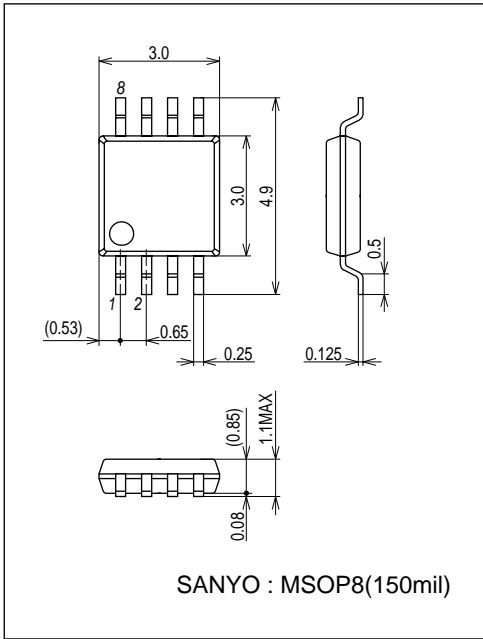

Specified Board (Top side)

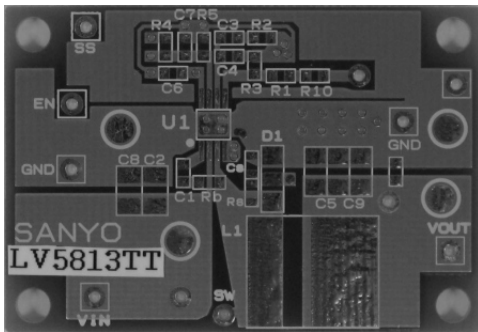

Specified Board (Bottom side)

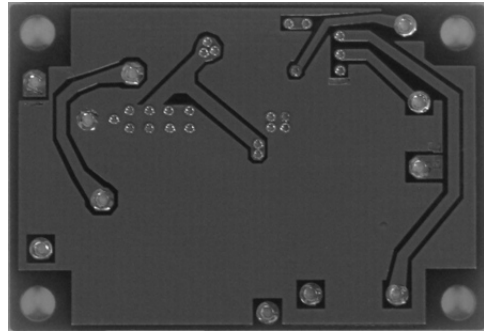

Pin Assignment

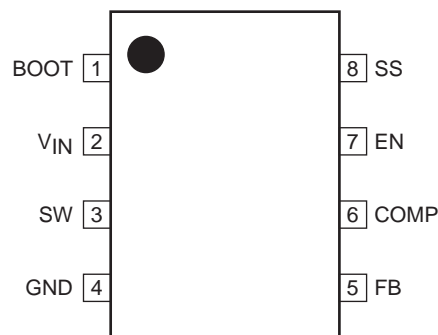

Top view

LV5813TT

Block Diagram and Sample Application Circuit (3.3V output)

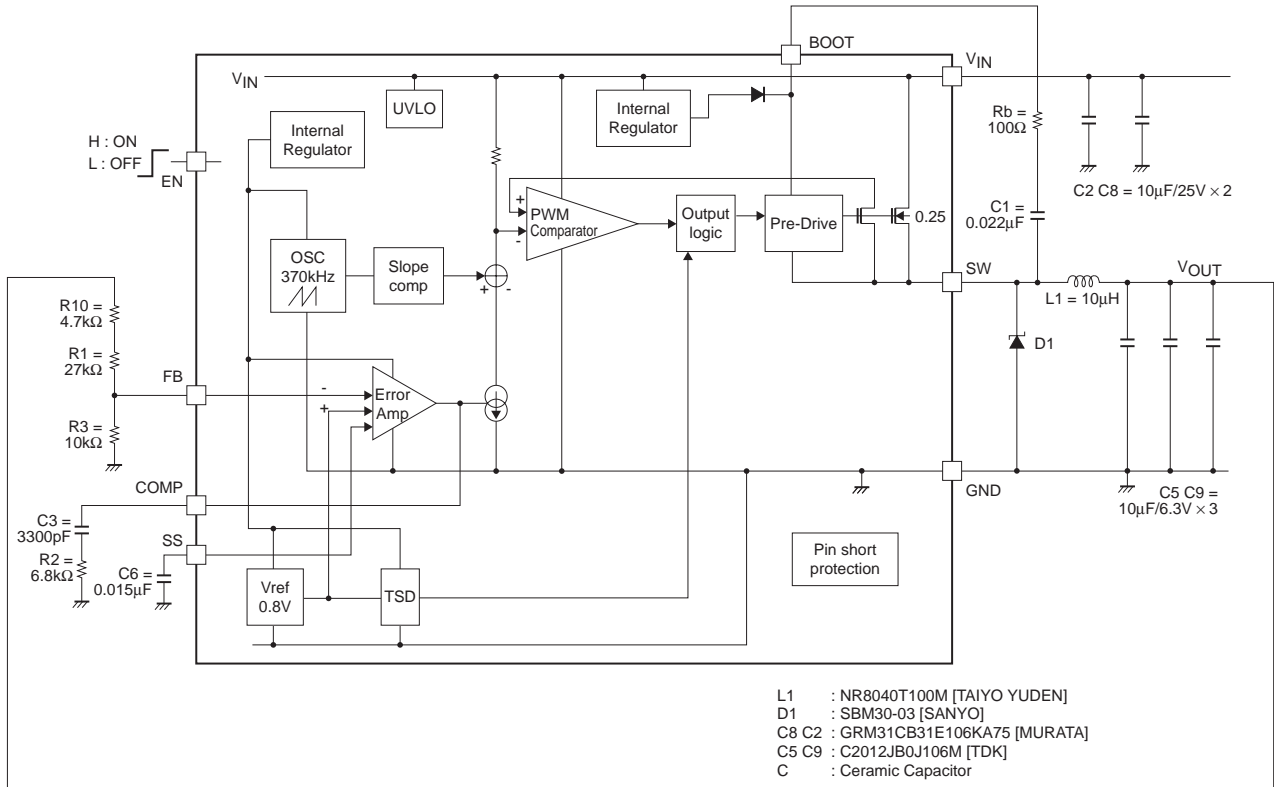

Pin Function

Pin No.	Pin name	Description	Equivalent Circuit
1	BOOT	Upper MOS transistor boot strap capacitance connection pin Connect the boot capacitance of about 0.022µF between SW pins To protect the SW pin's absolute maximum rating, to ensure stable operation, and to eliminate noise, the boot capacitance serial resistance (about 100Ω) Rb proves effective.	
2	V _{IN}	Input voltage pin. Connect substantially large (10µF 2 parameters or more) capacitance between this pin and GND.	See BOOT
3	SW	Power switch pin. Connect the output LC filter. Connect the above capacitance between this pin and BOOT pin.	See BOOT
4	GND	Ground pin.	-

Continued on next page.

LV5813TT

Continued from preceding page.

Pin No.	Pin name	Description	Equivalent Circuit
5	FB	<p>Feedback pin</p> <p>Sets the output voltage by means of split resistor in the section of the output voltage V_{OUT} - FB - GND. V_{OUT} setting is made as calculated below :</p> $V_{OUT} = V_{ref} \times \left\{ 1 + \frac{(R1 + R10)}{R3} \right\}$ <p style="text-align: center;">$V_{ref} = 0.8V$</p> <p>Example : 3.3V output voltage (See block diagram and sample application circuit)</p> $V_{OUT} = 0.8 \times \left\{ 1 + \frac{(27k + 4.3k)}{10k} \right\}$ <p style="text-align: center;">$= 3.304V$</p>	
6	COMP	<p>Phase compensation pin</p> <p>Connects with the phase compensation external capacitance and resistance of DC/DC converter close loop.</p>	
7	EN	<p>Enable pin</p> <p>Converter enabled when set to the HIGH voltage and disabled when connected to GND.</p>	
8	SS	<p>Soft start pin</p> <p>Set the soft start time by means of the built-in 5µA source voltage and external soft start capacity</p> <p>C_{ss} can be set as follows :</p> $C6 = 5\mu A \times \frac{T_{ss}}{V_{ref}}$ <p>Where, T_{ss} is soft start time and V_{ref} is the reference voltage.</p> <p>Example : 2.4ms soft start time achieved</p> $C_{ss} = 5\mu A \times \frac{2.4ms}{0.8V} = 0.015\mu F$	

LV5813TT

Reference data (1)

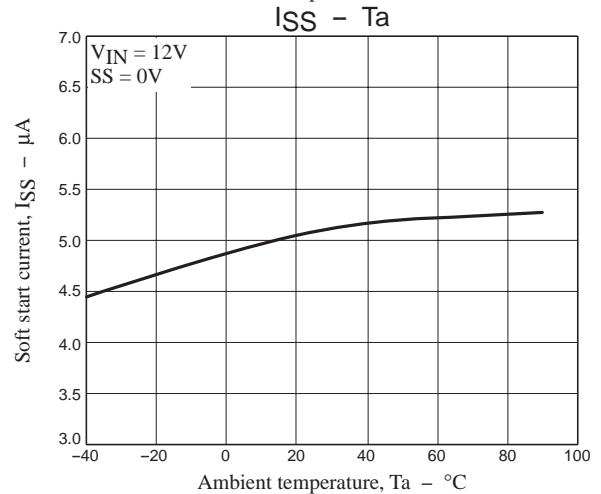
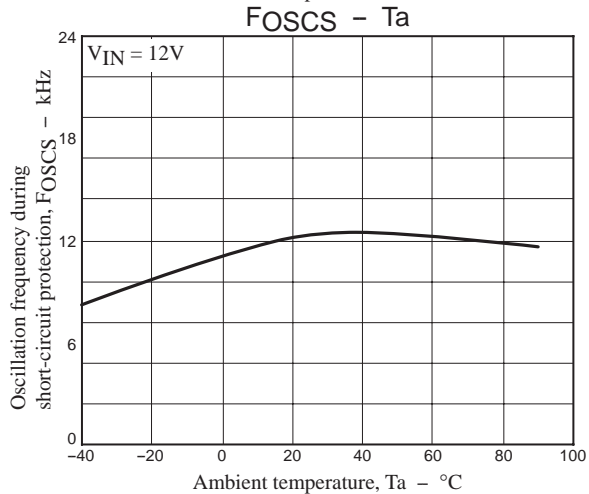
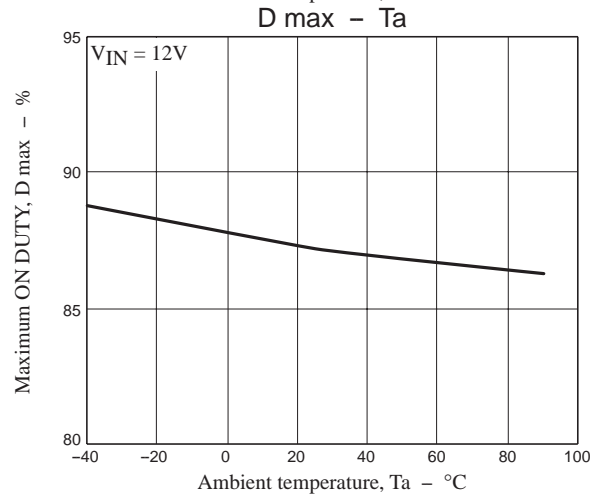
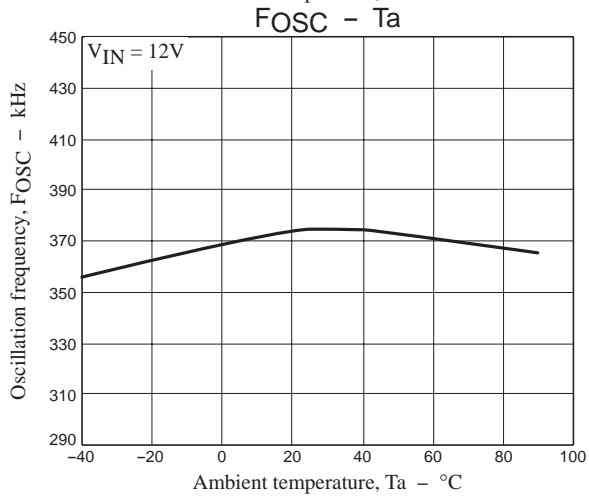
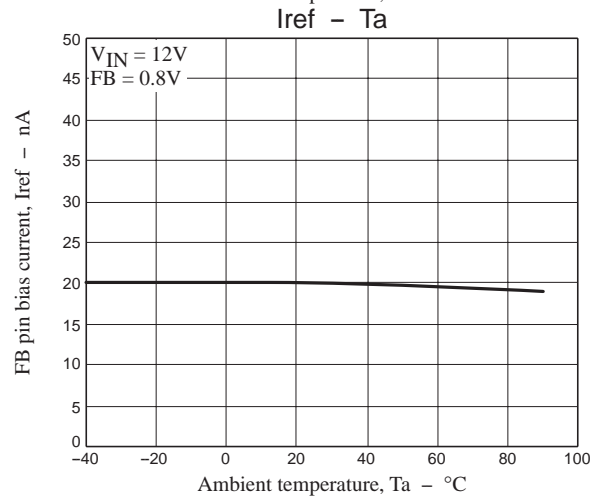
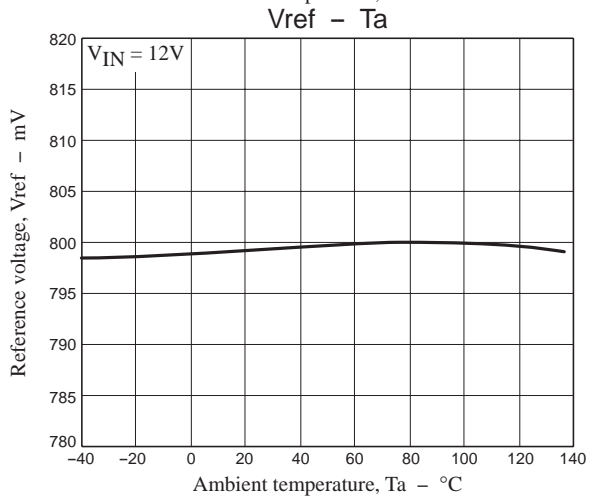
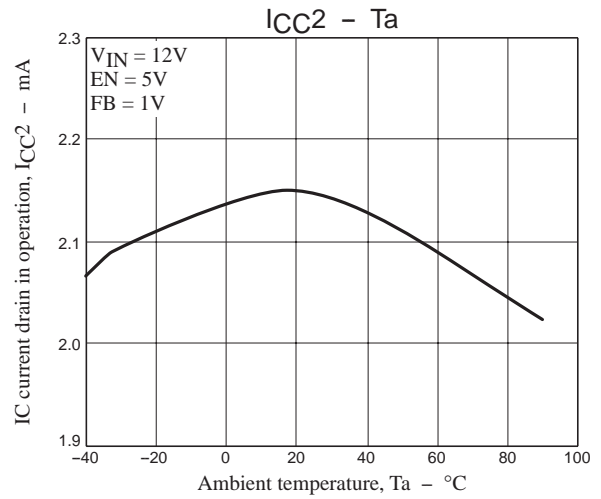
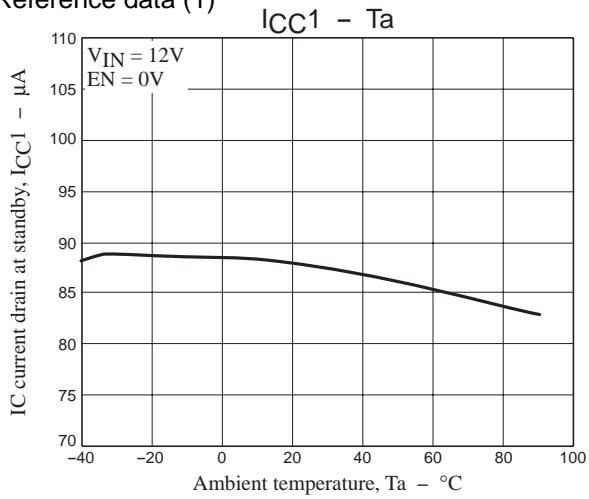

LV5813TT

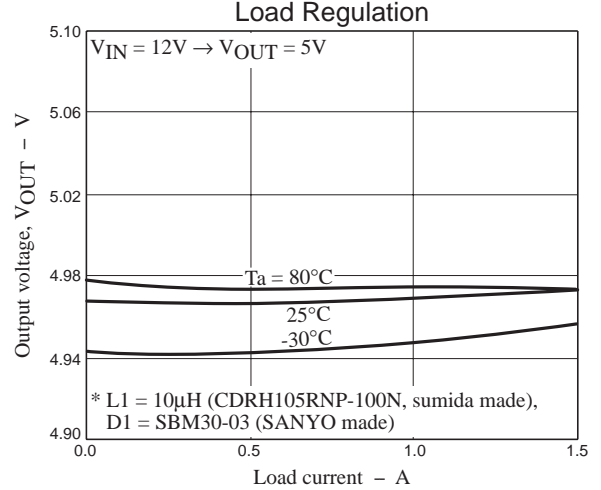
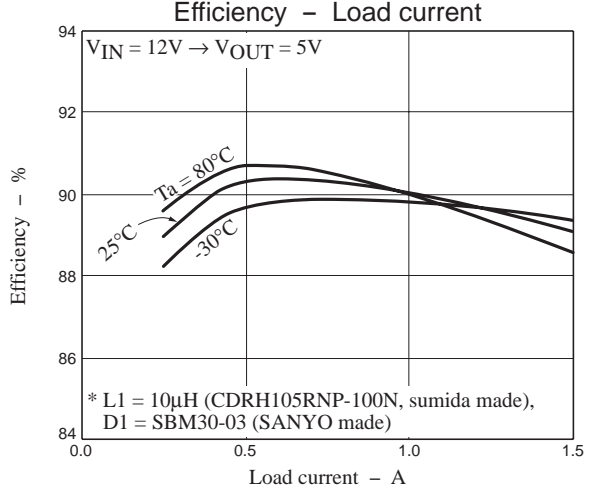
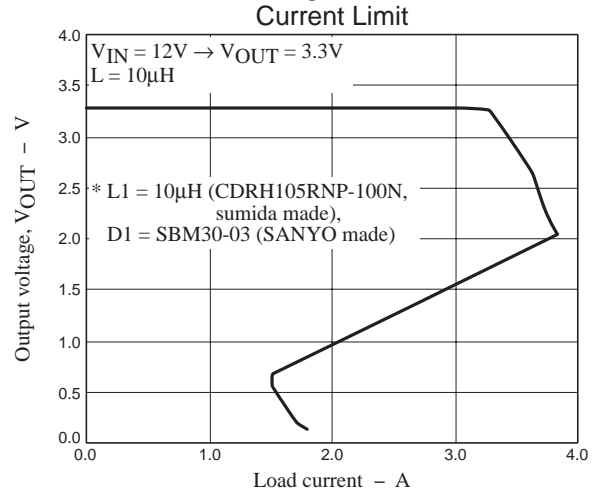
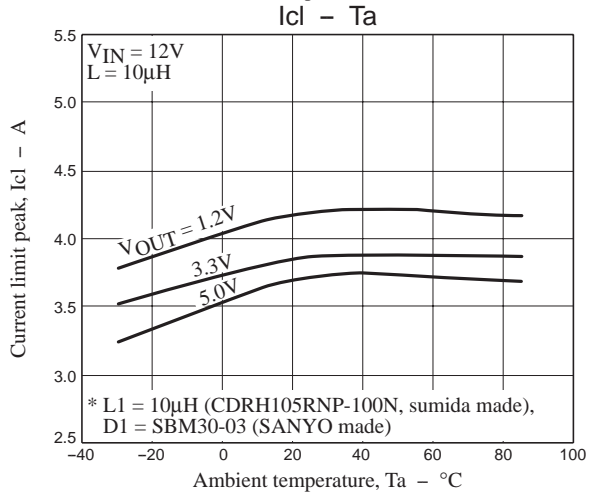
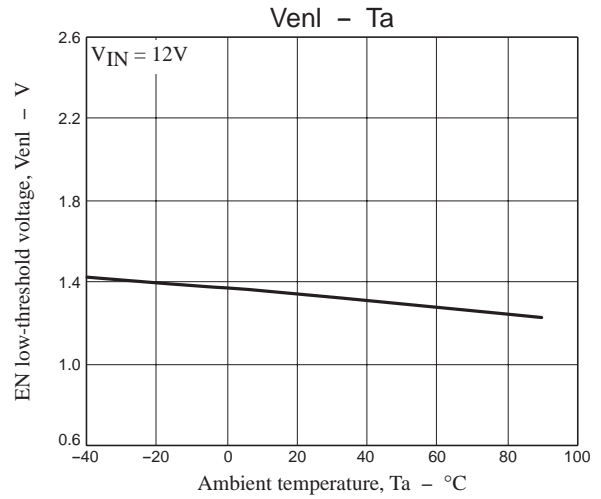
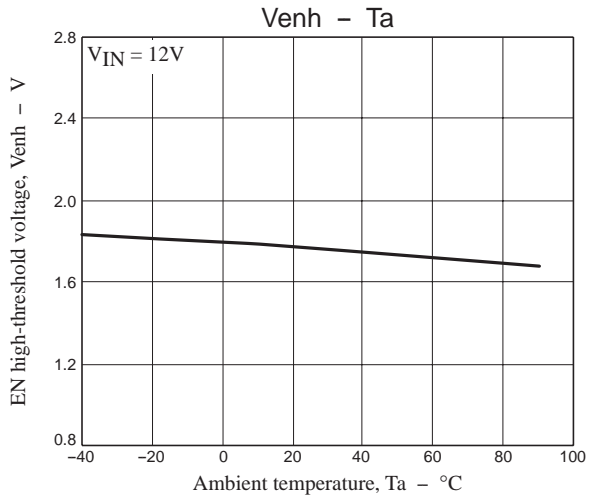

LV5813TT

Reference data (2)

(* measurement circuit is shown in “8. Sample Application circuit”, $V_{IN} = 12V \Rightarrow V_{OUT} = 3.3V$)

•Load transient response $I_{Load} = 0.5A \leftrightarrow 1.0A$ [100 μ sec/div]

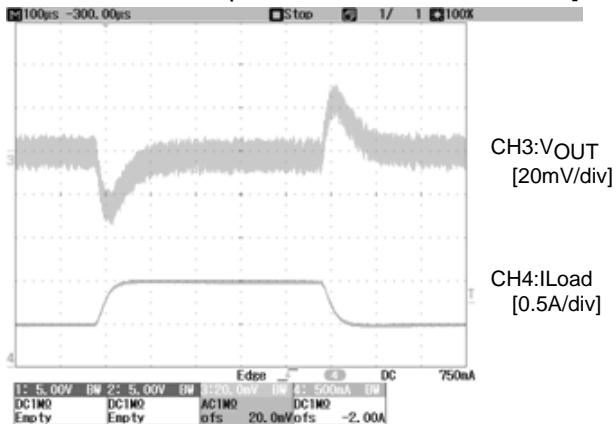

• V_{IN} start up waveform $I_{Load} = 0.5A$

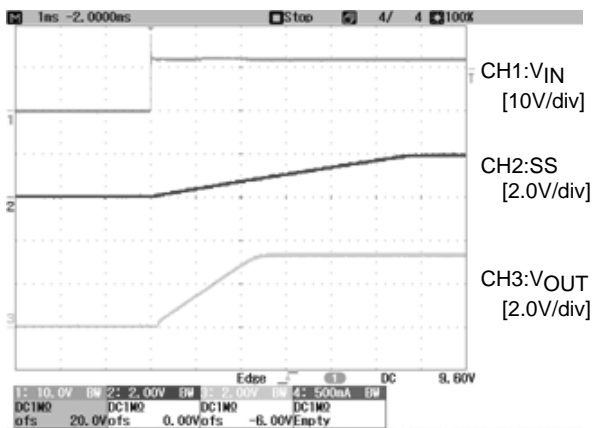

• V_{IN} stop waveform $I_{Load} = 0.5A$

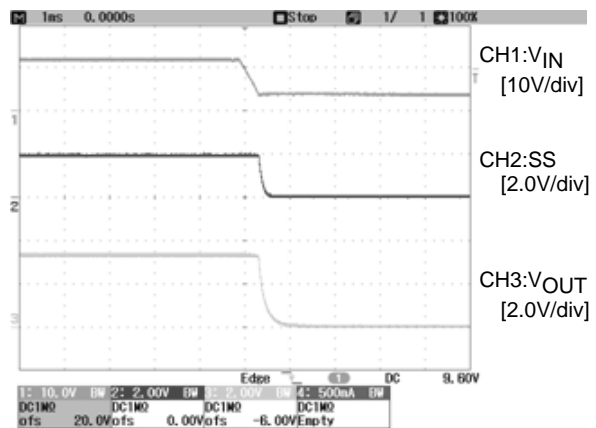

•EN start up waveform $I_{Load} = 0.5A$

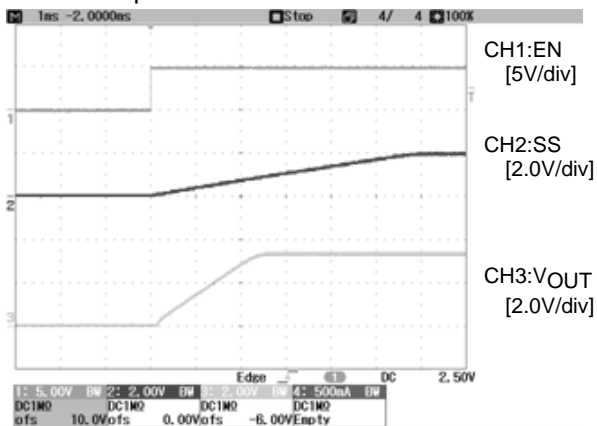

•EN stop waveform $I_{Load} = 0.5A$

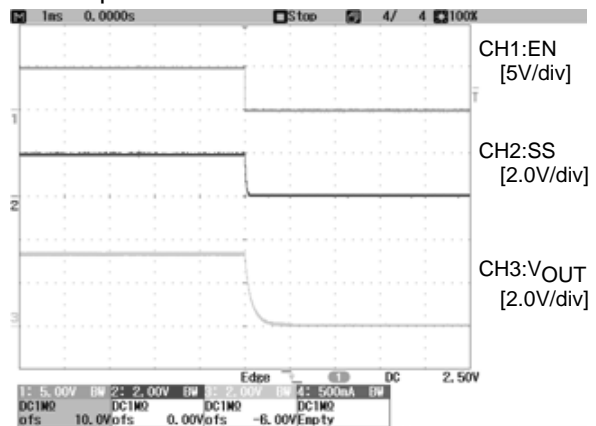

Considerations for the design

- During use with $V_{IN} = 12V$ or less, the boot strap voltage may become deficient due to intermittent operation at no load, resulting in failure of normal operation. In this case, insert a resistance of about 500Ω between V_{OUT} and GND and avoid the intermittent operation mode during use.
- Insertion of serial beads in the Schottky diode for removal of noise may cause generation of the negative voltage deviating from the absolute maximum rating at the SW pin, resulting in failure of normal operation. In such an event, do not insert beads as above described and, instead, remove noise by means of the BOOT resistance R_b .

- SANYO Semiconductor Co.,Ltd. assumes no responsibility for equipment failures that result from using products at values that exceed, even momentarily, rated values (such as maximum ratings, operating condition ranges, or other parameters) listed in products specifications of any and all SANYO Semiconductor Co.,Ltd. products described or contained herein.
- SANYO Semiconductor Co.,Ltd. strives to supply high-quality high-reliability products, however, any and all semiconductor products fail or malfunction with some probability. It is possible that these probabilistic failures or malfunction could give rise to accidents or events that could endanger human lives, trouble that could give rise to smoke or fire, or accidents that could cause damage to other property. When designing equipment, adopt safety measures so that these kinds of accidents or events cannot occur. Such measures include but are not limited to protective circuits and error prevention circuits for safe design, redundant design, and structural design.
- In the event that any or all SANYO Semiconductor Co.,Ltd. products described or contained herein are controlled under any of applicable local export control laws and regulations, such products may require the export license from the authorities concerned in accordance with the above law.
- No part of this publication may be reproduced or transmitted in any form or by any means, electronic or mechanical, including photocopying and recording, or any information storage or retrieval system, or otherwise, without the prior written consent of SANYO Semiconductor Co.,Ltd.
- Any and all information described or contained herein are subject to change without notice due to product/technology improvement, etc. When designing equipment, refer to the "Delivery Specification" for the SANYO Semiconductor Co.,Ltd. product that you intend to use.
- Information (including circuit diagrams and circuit parameters) herein is for example only; it is not guaranteed for volume production.
- Upon using the technical information or products described herein, neither warranty nor license shall be granted with regard to intellectual property rights or any other rights of SANYO Semiconductor Co.,Ltd. or any third party. SANYO Semiconductor Co.,Ltd. shall not be liable for any claim or suits with regard to a third party's intellectual property rights which has resulted from the use of the technical information and products mentioned above.

This catalog provides information as of July, 2010. Specifications and information herein are subject to change without notice.