

3 mm (T1) LED, Non Diffused

LS 3340, LO 3340, LY 3340, LG 3330, LP 3340



Besondere Merkmale

- **Gehäusetyp:** eingefärbtes, klares 3 mm (T1) Gehäuse
- **Besonderheit des Bauteils:** Lötspieße mit Aufsetzebene
- **Wellenlänge:** 628 nm (super-rot), 606 nm (orange), 587 nm (gelb), 570 nm (grün), 560 nm (pure green)
- **Abstrahlwinkel:** 50°
- **Technologie:** GaAlP (super-rot, orange, gelb, grün), GaP (pure green)
- **optischer Wirkungsgrad:** 1,5 lm/W (super-rot, orange, gelb), 2,5 lm/W (grün), 0,6 lm/W (pure green)
- **Gruppierungsparameter:** Lichtstärke
- **Lötmethode:** Wellenlöten (TTW)
- **Verpackung:** Schüttgut, gegurtet lieferbar

Anwendungen

- optischer Indikator
- Hinterleuchtung (LCD, Handy, Schalter, Tasten, Displays, Werbebeleuchtung, Allgemeinbeleuchtung)
- Signal- und Symbolleuchten
- Markierungsbeleuchtung (z.B. Stufen, Fluchtwege, u.ä.)
- Innenbeleuchtung im Automobilbereich (z.B. Instrumentenbeleuchtung, u.ä.)
- Leuchtschriftanzeigen

Features

- **package:** colored, clear 3 mm (T1) package
- **feature of the device:** solder leads with stand-off
- **wavelength:** 628 nm (super-red), 606 nm (orange), 587 nm (yellow), 570 nm (green), 560 nm (pure green)
- **viewing angle:** 50°
- **technology:** GaAlP (super-red, orange, yellow, green), GaP (pure green)
- **optical efficiency:** 1.5 lm/W (super-red, orange, yellow), 2.5 lm/W (green), 0.6 lm/W (pure green)
- **grouping parameter:** luminous intensity
- **soldering methods:** TTW soldering
- **packing:** bulk, available taped on reel

Applications

- optical indicators
- backlighting (LCD, cellular phones, switches, keys, displays, illuminated advertising, general lighting)
- signal and symbol luminaire
- marker lights (e.g. steps, exit ways, etc.)
- interior automotive lighting (e.g. dashboard backlighting, etc.)
- light writing displays

LS 3340, LO 3340, LY 3340, LG 3330, LP 3340

| Typ Type | Emissions- farbe Color of Emission | Gehäuse- farbe Color of Package | Lichtstärke Luminous Intensity $I_F = 10 \text{ mA}$ $I_V \text{ (mcd)}$ | Lichtstrom Luminous Flux $I_F = 10 \text{ mA}$ $\Phi_V \text{ (mlm)}$ | Bestellnummer Ordering Code |
|---|---|--|--|---|--|
| LS 3340-KN LS 3340-L LS 3340-M LS 3340-N LS 3340-LP | super-red | red clear | 7.1 ... 45.0 11.2 ... 18.0 18.0 ... 28.0 28.0 ... 45.0 11.2 ... 71.0 | 35 (typ.) 20 (typ.) 30 (typ.) 45 (typ.) 55 (typ.) | Q62703-Q1701 Q62703-Q1702 Q62703-Q1704 Q62703-Q2320 Q62703-Q3223 |
| LO 3340-KN LO 3340-L LO 3340-M LO 3340-N LO 3340-LP | orange | orange clear | 7.1 ... 45.0 11.2 ... 18.0 18.0 ... 28.0 28.0 ... 45.0 11.2 ... 71.0 | 35 (typ.) 20 (typ.) 30 (typ.) 45 (typ.) 55 (typ.) | Q62703-Q1886 Q62703-Q2256 Q62703-Q2255 Q62703-Q2473 Q62703-Q2628 |
| LY 3340-JM LY 3340-L LY 3340-M LY 3340-N LY 3340-LP | yellow | yellow clear | 4.5 ... 28.0 11.2 ... 18.0 18.0 ... 28.0 28.0 ... 45.0 11.2 ... 71.0 | 20 (typ.) 20 (typ.) 30 (typ.) 45 (typ.) 55 (typ.) | Q62703-Q1789 Q62703-Q1791 Q62703-Q1999 Q62703-Q2652 Q62703-Q1792 |
| LG 3330-KN LG 3330-M LG 3330-N LG 3330-LP | green | colorless clear | 7.1 ... 45.0 18.0 ... 28.0 28.0 ... 45.0 11.2 ... 71.0 | 35 (typ.) 30 (typ.) 45 (typ.) 55 (typ.) | Q62703-Q1698 Q62703-Q1700 Q62703-Q2010 Q62703-Q2011 |
| LP 3340-JL LP 3340-K LP 3340-L LP 3340-KM | pure green | green clear | 4.5 ... 18.0 7.1 ... 11.2 11.2 ... 18.0 7.1 ... 28.0 | 10 (typ.) 9 (typ.) 14 (typ.) 17 (typ.) | Q62703-Q2749 Q62703-Q2982 Q62703-Q2980 Q62703-Q3211 |

Helligkeitswerte werden mit einer Stromeinprägedauer von 25 ms und einer Genauigkeit von $\pm 11 \%$ ermittelt.
Luminous intensity is tested at a current pulse duration of 25 ms and a tolerance of $\pm 11 \%$.

Anm.: Die Standardlieferform von Serientypen beinhaltet eine untere bzw. eine obere Familiengruppe oder mindestens zwei Einzelgruppen.

In einer Verpackungseinheit / Gurt ist immer nur eine Helligkeitsgruppe enthalten.

Die technologiebedingte Helligkeits-Streuung der heutigen LED-Herstellprozesse über einen längeren Fertigungszeitraum (Halbleitermaterial - Chipherstellung - Montageprozess) erlaubt keine Zusage einer einzelnen Helligkeitsgruppe. Daher müssen mindestens zwei Helligkeitsgruppen vorgesehen werden!

Note: The standard shipping format for serial types includes a lower or upper family group or at least two individual groups.

No packing unit / tape ever contains more than one luminous intensity group.

Luminosity variations caused by the technology used in current LED manufacturing processes over a protracted manufacturing period (semiconductor material - chip fabrication - assembly process) mean that it is not possible to assign LEDs to a single luminous intensity group. For this reason at least two luminous intensity groups must be provided!

Grenzwerte
Maximum Ratings

| Bezeichnung Parameter | Symbol Symbol | Wert Value | | Einheit Unit |
|--|--------------------------------|-------------------|----|-----------------|
| | | LS, LO, LY, LG | LP | |
| Betriebstemperatur Operating temperature range | T_{op} | - 55 ... + 100 | | °C |
| Lagertemperatur Storage temperature range | T_{stg} | - 55 ... + 100 | | °C |
| Sperrschichttemperatur Junction temperature | T_j | + 100 | | °C |
| Durchlassstrom Forward current | I_F | 40 | 30 | mA |
| Stoßstrom Surge current $t \leq 10 \mu s, D = 0.005$ | I_{FM} | 0.5 | | A |
| Sperrspannung Reverse voltage | V_R | 5 | | V |
| Leistungsaufnahme Power consumption $T_A \leq 25 \text{ °C}$ | P_{tot} | 130 | 95 | mW |
| Wärmewiderstand ¹⁾ Thermal resistance Sperrschicht/Umgebung Junction/ambient Sperrschicht/Löt看pad Junction/soldering point Montage auf PC-Board FR 4 (Padgröße $\geq 16 \text{ mm}^2$) mounted on PC board FR 4 (pad size $\geq 16 \text{ mm}^2$) Minimale Beinchenlänge Minimum lead length | $R_{th JA}$ $R_{th JS}$ | 400 180 | | K/W K/W |

¹⁾ R_{th} erhöht sich um 13 K/W pro mm Beinchenlänge.
Each additional 1 mm of lead length increases R_{th} by 13 K/W.

Kennwerte ($T_A = 25\text{ °C}$)

Characteristics

| Bezeichnung Parameter | Symbol Symbol | Wert Value | | | | | Einheit Unit |
|---|------------------------------|---------------|------------|------------|------------|------------|--------------------------------|
| | | LS | LO | LY | LG | LP | |
| Wellenlänge des emittierten Lichtes (typ.) Wavelength at peak emission $I_F = 10\text{ mA}$ | λ_{peak} | 635 | 610 | 586 | 572 | 557 | nm |
| Dominantwellenlänge ¹⁾ (typ.) Dominant wavelength $I_F = 10\text{ mA}$ | λ_{dom} | 628 | 606 | 587 | 570 | 560 | nm |
| Spektrale Bandbreite bei 50 % $I_{\text{rel max}}$ (typ.) Spectral bandwidth at 50 % $I_{\text{rel max}}$ $I_F = 10\text{ mA}$ | $\Delta\lambda$ | 45 | 40 | 45 | 25 | 22 | nm |
| Abstrahlwinkel bei 50 % I_V (Vollwinkel) (typ.) Viewing angle at 50 % I_V | 2ϕ | 50 | 50 | 50 | 50 | 50 | Grad deg. |
| Durchlassspannung ²⁾ (typ.) Forward voltage $I_F = 10\text{ mA}$ | V_F V_F | 2.0 2.5 | 2.0 2.5 | 2.0 2.5 | 2.0 2.5 | 2.0 2.5 | V V |
| Sperrstrom (typ.) Reverse current $V_R = 5\text{ V}$ | I_R I_R | 0.01 10 | 0.01 10 | 0.01 10 | 0.01 10 | 0.01 10 | μA μA |
| Temperaturkoeffizient von λ_{peak} (typ.) Temperature coefficient of λ_{peak} $I_F = 10\text{ mA}; -10\text{ °C} \leq T \leq 100\text{ °C}$ | $TC_{\lambda_{\text{peak}}}$ | 0.11 | 0.12 | 0.10 | 0.11 | 0.11 | nm/K |
| Temperaturkoeffizient von λ_{dom} (typ.) Temperature coefficient of λ_{dom} $I_F = 10\text{ mA}; -10\text{ °C} \leq T \leq 100\text{ °C}$ | $TC_{\lambda_{\text{dom}}}$ | 0.07 | 0.07 | 0.07 | 0.07 | 0.05 | nm/K |
| Temperaturkoeffizient von V_F (typ.) Temperature coefficient of V_F $I_F = 10\text{ mA}; -10\text{ °C} \leq T \leq 100\text{ °C}$ | TC_V | -1.9 | -1.9 | -1.9 | -1.4 | -2.1 | mV/K |
| Optischer Wirkungsgrad (typ.) Optical efficiency $I_F = 10\text{ mA}$ | η_{opt} | 1.5 | 1.5 | 1.5 | 2.5 | 0.6 | lm/W |

¹⁾ Wellenlängen werden mit einer Stromeinprägedauer von 25 ms und einer Genauigkeit von $\pm 1\text{ nm}$ ermittelt.
Wavelengths are tested at a current pulse duration of 25 ms and a tolerance of $\pm 1\text{ nm}$.

²⁾ Spannungswerte werden mit einer Stromeinprägedauer von 1 ms und einer Genauigkeit von $\pm 0,1\text{ V}$ ermittelt.
Voltages are tested at a current pulse duration of 1 ms and a tolerance of $\pm 0.1\text{ V}$.

Relative spektrale Emission $I_{rel} = f(\lambda)$, $T_A = 25\text{ }^\circ\text{C}$, $I_F = 10\text{ mA}$

Relative Spectral Emission

$V(\lambda)$ = spektrale Augenempfindlichkeit

Standard eye response curve

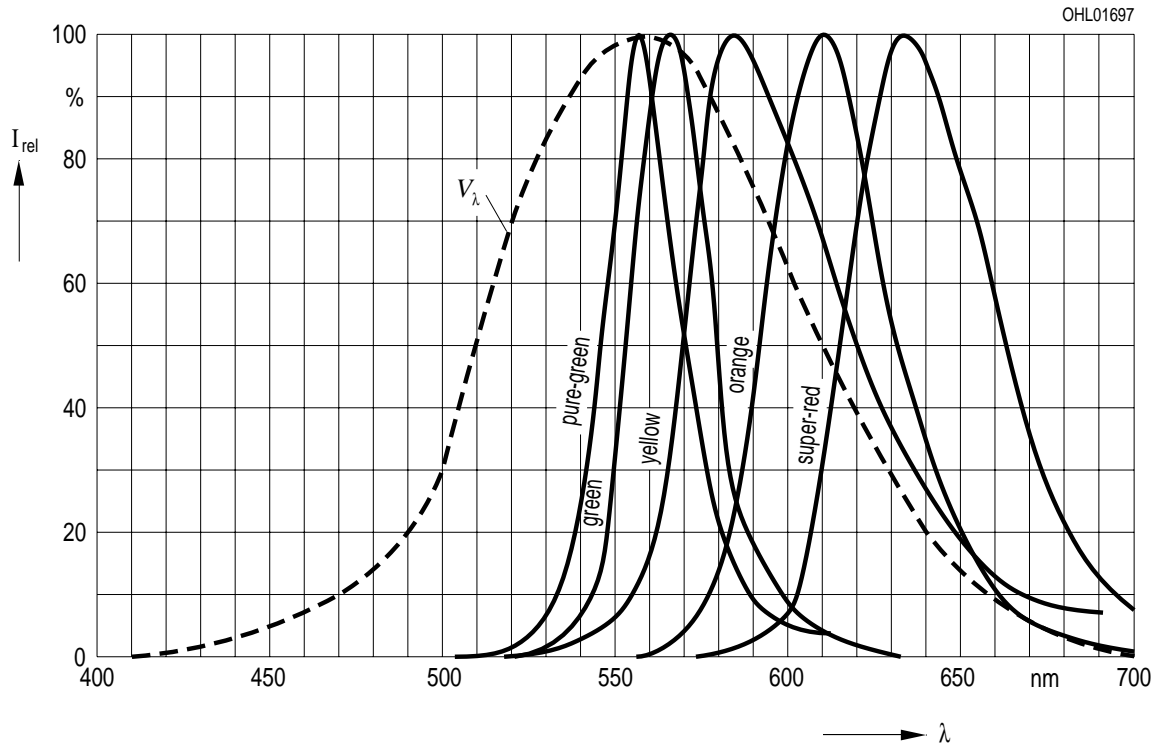

Abstrahlcharakteristik $I_{rel} = f(\varphi)$

Radiation Characteristic

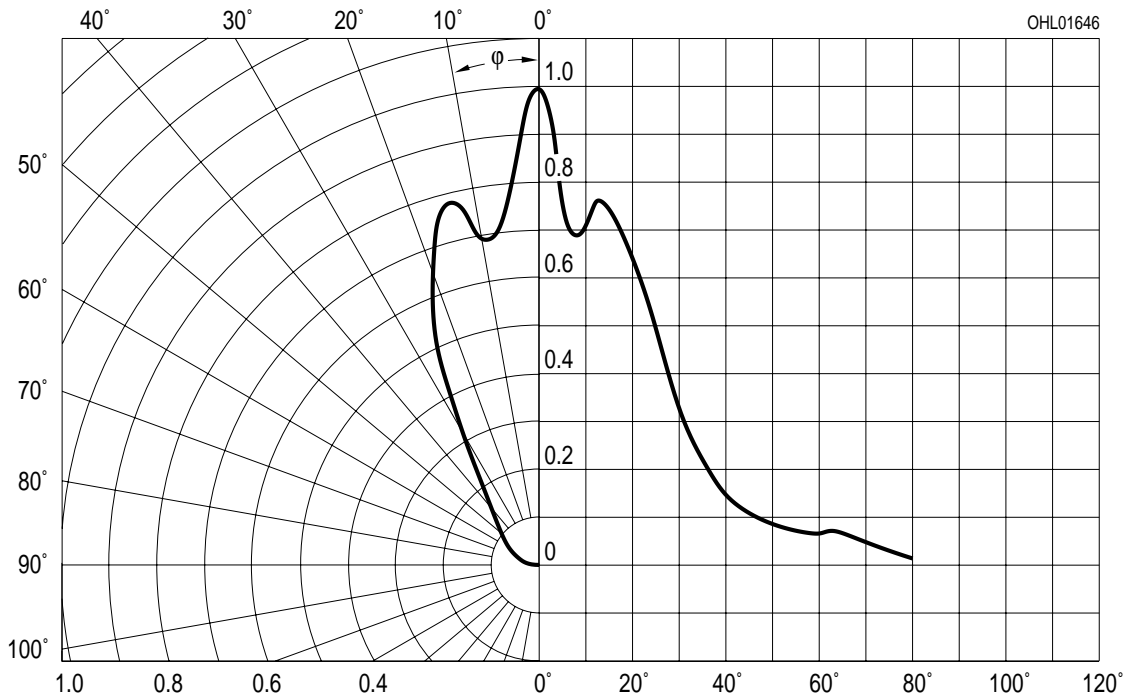

Durchlassstrom $I_F = f(V_F)$
Forward Current

$T_A = 25\text{ °C}$

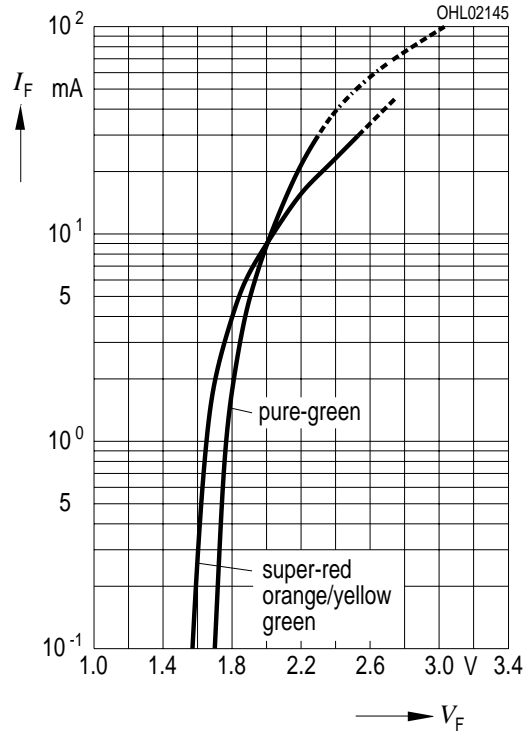

Relative Lichtstärke $I_V/I_{V(10\text{ mA})} = f(I_F)$
Relative Luminous Intensity

$T_A = 25\text{ °C}$

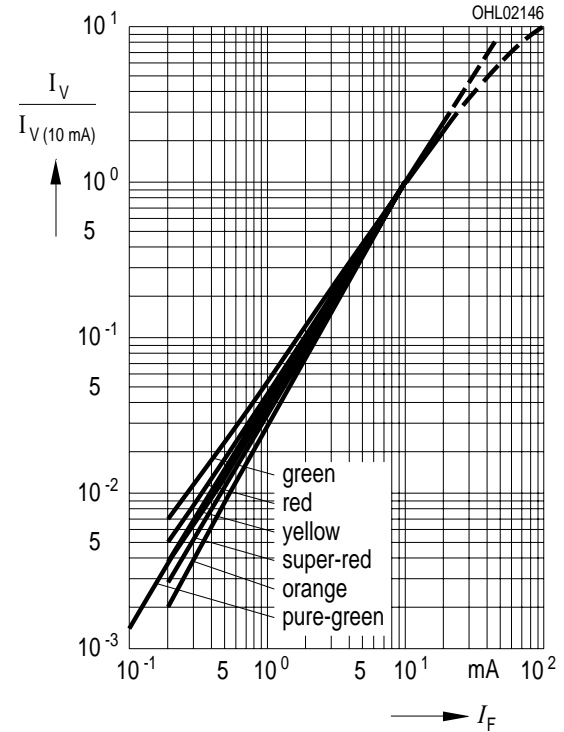

Maximal zulässiger Durchlassstrom $I_F = f(T)$
Max. Permissible Forward Current
LS, LO, LY, LG

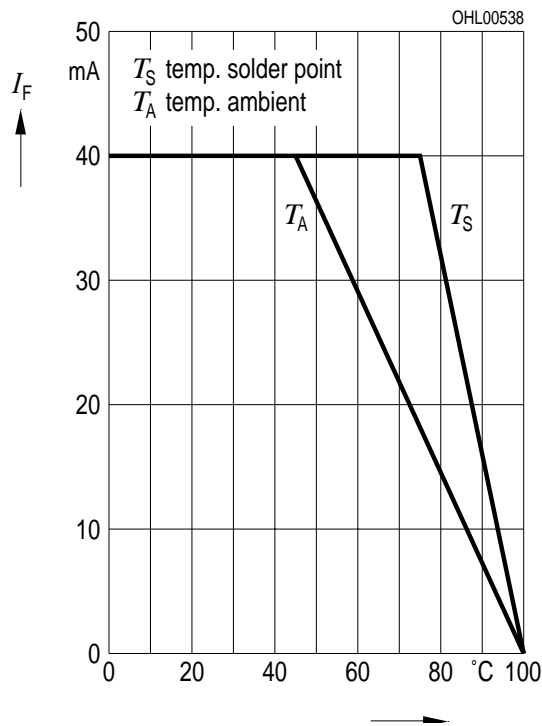

Maximal zulässiger Durchlassstrom $I_F = f(T)$
Max. Permissible Forward Current
LP

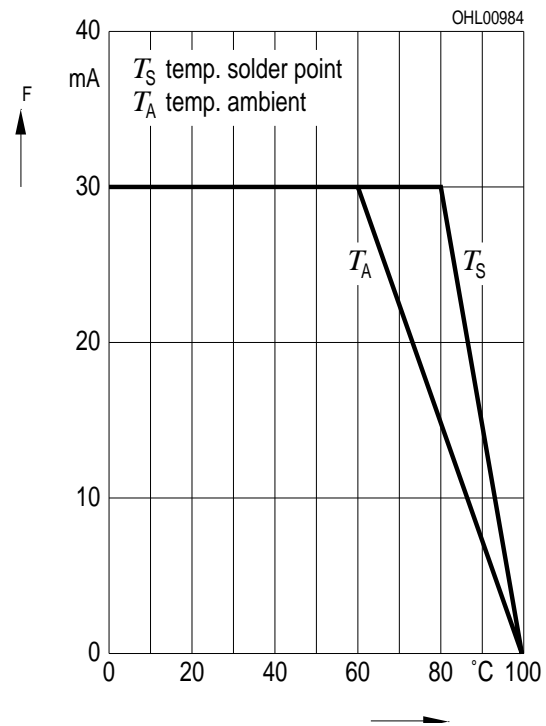

Relative Lichtstärke $I_V/I_{V(25^\circ\text{C})} = f(T_A)$
 Relative Luminous Intensity $I_F = 10 \text{ mA}$

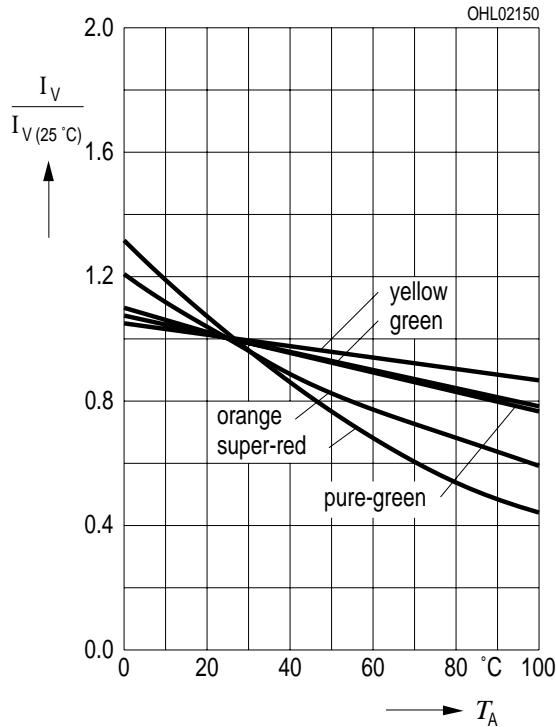

Zulässige Impulsbelastbarkeit $I_F = f(t_p)$
 Permissible Pulse Handling Capability
 Duty cycle $D = \text{parameter}$, $T_A = 25^\circ\text{C}$
 LS, LO, LY, LG

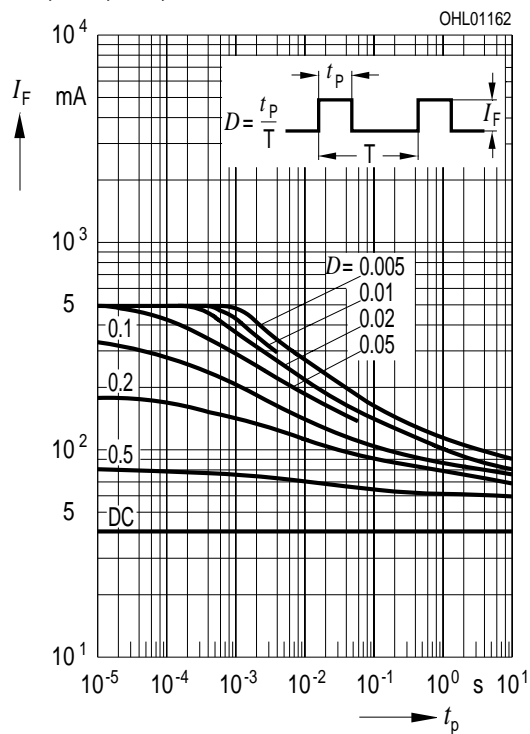

Zulässige Impulsbelastbarkeit $I_F = f(t_p)$
 Permissible Pulse Handling Capability
 Duty cycle $D = \text{parameter}$, $T_A = 25^\circ\text{C}$
 LP

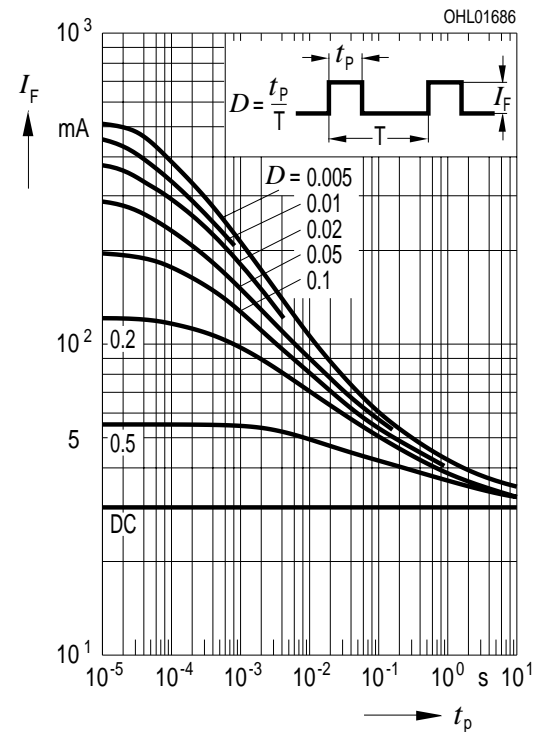

**Maßzeichnung
Package Outlines**

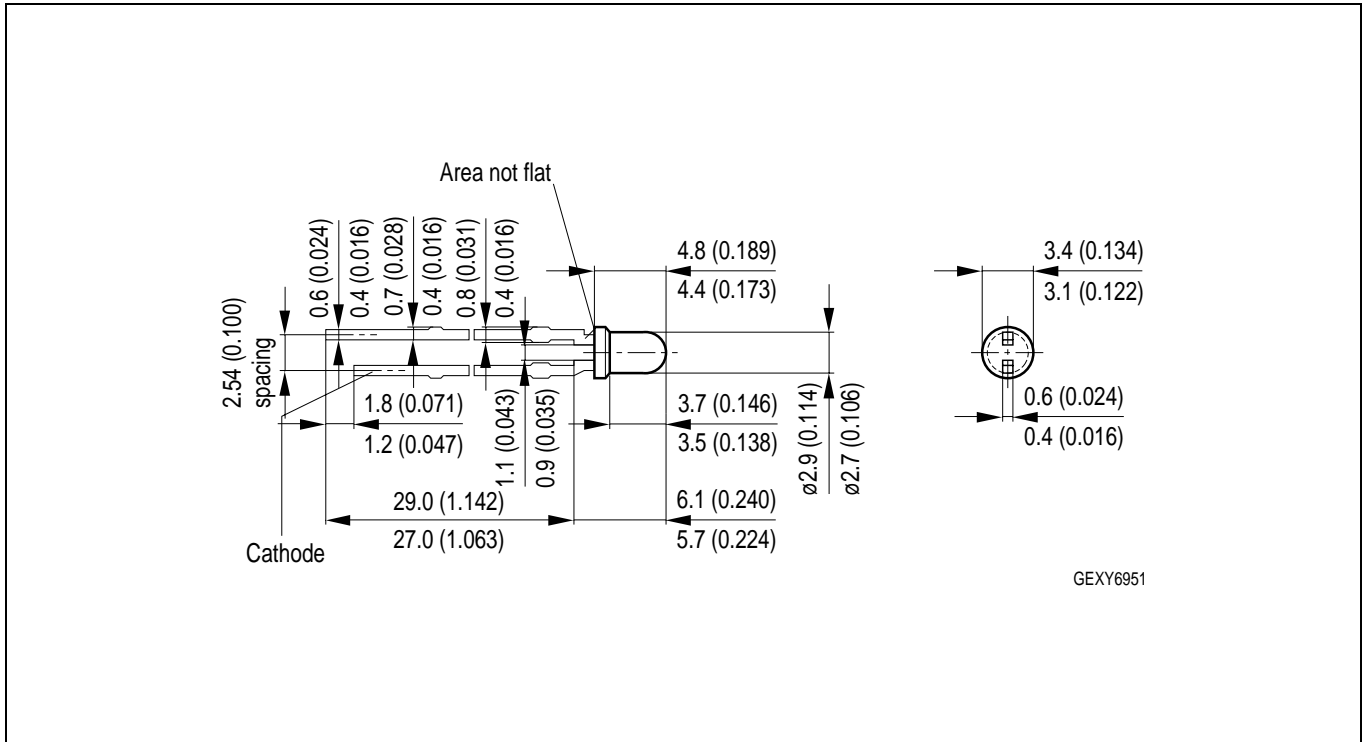

Maße werden wie folgt angegeben: mm (inch) / Dimensions are specified as follows: mm (inch).

Kathodenkennung: kürzerer Lötspieß
Cathode mark: short solder lead
Gewicht / Approx. weight: 0.15 g

Lötbedingungen
Soldering Conditions

Wellenlöten (TTW) (nach CECC 00802)
TTW Soldering (acc. to CECC 00802)

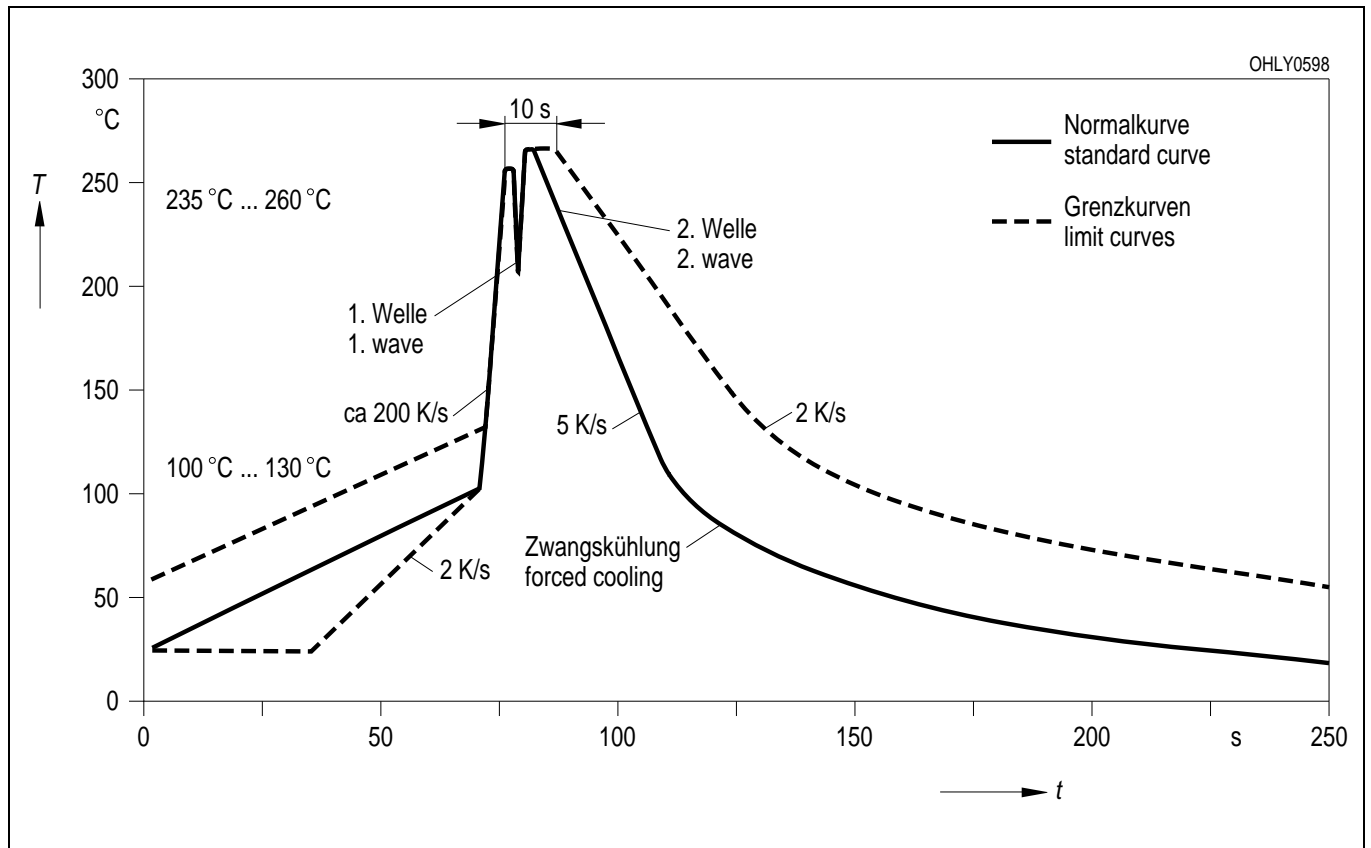

Empfohlenes Lötpaddesign Wellenlöten (TTW)
Recommended Solder Pad TTW Soldering

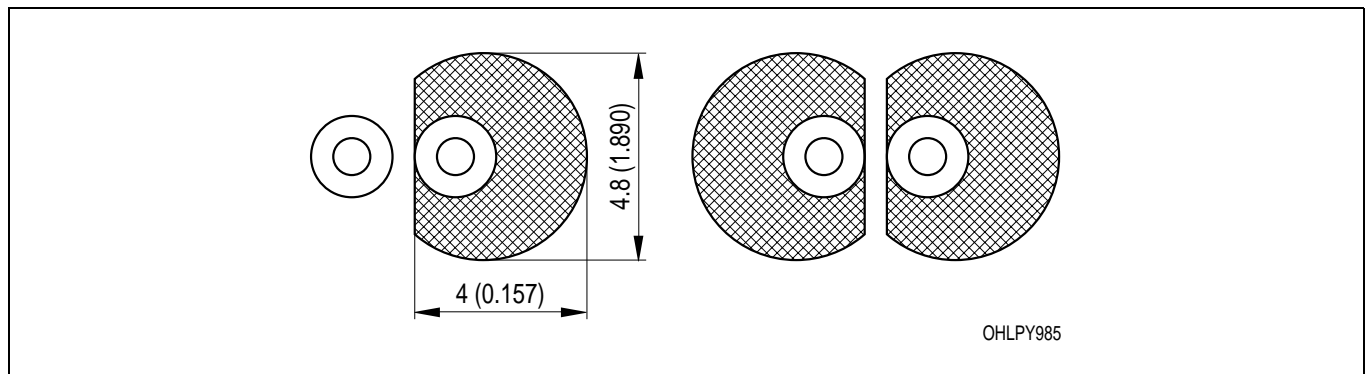

Maße werden wie folgt angegeben: mm (inch) / Dimensions are specified as follows: mm (inch).

Revision History: 2002-03-14

Previous Version: 2001-03-12

| Page | Subjects (major changes since last revision) |
|------|--|
| 3 | thermal resistance (footnote) |
| 4 | dominant wavelength (orange) |

Published by OSRAM Opto Semiconductors GmbH & Co. OHG

Wernerwerkstrasse 2, D-93049 Regensburg

© All Rights Reserved.

Attention please!

The information describes the type of component and shall not be considered as assured characteristics. Terms of delivery and rights to change design reserved. Due to technical requirements components may contain dangerous substances. For information on the types in question please contact our Sales Organization. If printed or downloaded, please find the latest version in the Internet.

Packing

Please use the recycling operators known to you. We can also help you – get in touch with your nearest sales office. By agreement we will take packing material back, if it is sorted. You must bear the costs of transport. For packing material that is returned to us unsorted or which we are not obliged to accept, we shall have to invoice you for any costs incurred.

Components used in life-support devices or systems must be expressly authorized for such purpose! Critical components ¹ may only be used in life-support devices or systems ² with the express written approval of OSRAM OS.

¹ A critical component is a component used in a life-support device or system whose failure can reasonably be expected to cause the failure of that life-support device or system, or to affect its safety or the effectiveness of that device or system.

² Life support devices or systems are intended (a) to be implanted in the human body, or (b) to support and/or maintain and sustain human life. If they fail, it is reasonable to assume that the health of the user may be endangered.