

3 mm (T1) LED, Non Diffused

LS 3340, LO 3340, LY 3340
LG 3330, LP 3340

Besondere Merkmale

- eingefärbtes, klares Gehäuse
- zur Einkopplung in Lichtleiter
- als optischer Indikator einsetzbar
- Lötspieße mit Aufsetzebene
- gegurtet lieferbar
- Störimpulsfest nach DIN 40839

Features

- colored, clear package
- optical coupling into light pipes
- for use as optical indicator
- solder leads with stand-off
- available taped on reel
- load dump resistant acc. to DIN 40839

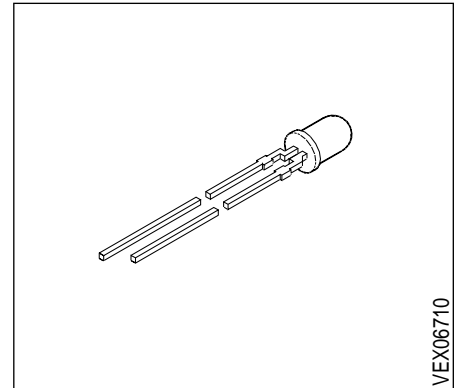

Typ Type	Emissionsfarbe Color of Emission	Gehäusefarbe Color of Package	Lichtstärke Luminous Intensity $I_F = 10 \text{ mA}$ $I_V \text{ (mcd)}$	Bestellnummer Ordering Code
LS 3340-KN LS 3340-L LS 3340-M LS 3340-N LS 3340-LP	super-red	red clear	6.3 ... 50.0 10.0 ... 20.0 16.0 ... 32.0 25.0 ... 50.0 10.0 ... 80.0	Q62703-Q1701 Q62703-Q1702 Q62703-Q1704 Q62703-Q2320 Q62703-Q3223
LO 3340-KN LO 3340-L LO 3340-M LO 3340-N LO 3340-LP	orange	orange clear	6.3 ... 50.0 10.0 ... 20.0 16.0 ... 32.0 25.0 ... 50.0 10.0 ... 80.0	Q62703-Q1886 Q62703-Q2256 Q62703-Q2255 Q62703-Q2473 Q62703-Q2628
LY 3340-JM LY 3340-L LY 3340-M LY 3340-N LY 3340-LP	yellow	yellow clear	4.0 ... 32.0 10.0 ... 20.0 16.0 ... 32.0 25.0 ... 50.0 10.0 ... 80.0	Q62703-Q1789 Q62703-Q1791 Q62703-Q1999 Q62703-Q2652 Q62703-Q1792
LG 3330-KN LG 3330-L LG 3330-M LG 3330-N LG 3330-LP	green	colorless clear	6.3 ... 50.0 10.0 ... 20.0 16.0 ... 32.0 25.0 ... 50.0 10.0 ... 80.0	Q62703-Q1698 Q62703-Q1699 Q62703-Q1700 Q62703-Q2010 Q62703-Q2011
LP 3340-JL LP 3340-K LP 3340-L LP 3340-KM	pure green	green clear	4.0 ... 20.0 6.3 ... 12.5 10.0 ... 20.0 6.3 ... 32.0	Q62703-Q2749 Q62703-Q2982 Q62703-Q2980 Q62703-Q3211

Streuung der Lichtstärke in einer Verpackungseinheit $I_{V \max} / I_{V \min} \leq 2.0$.
Luminous intensity ratio in one packaging unit $I_{V \max} / I_{V \min} \leq 2.0$.

Grenzwerte
Maximum Ratings

Bezeichnung Parameter	Symbol Symbol	Werte Values		Einheit Unit
		LS, LO, LY, LG	LP	
Betriebstemperatur Operating temperature range	T_{op}	- 55 ... + 100		°C
Lagertemperatur Storage temperature range	T_{stg}	- 55 ... + 100		°C
Sperrschichttemperatur Junction temperature	T_j	+ 100		°C
Durchlaßstrom Forward current	I_F	40	30	mA
Stoßstrom Surge current $t \leq 10 \mu s, D = 0.005$	I_{FM}	0.5		A
Sperrspannung Reverse voltage	V_R	5		V
Verlustleistung Power dissipation $T_A \leq 25 \text{ °C}$	P_{tot}	140	100	mW
Wärmewiderstand Thermal resistance Sperrschicht / Luft Junction / air	$R_{th JA}$	400		K/W

Kennwerte ($T_A = 25\text{ °C}$)

Characteristics

Bezeichnung Parameter	Symbol Symbol	Werte Values					Einheit Unit
		LS	LO	LY	LG	LP	
Wellenlänge des emittierten Lichtes Wavelength at peak emission $I_F = 20\text{ mA}$	(typ.) λ_{peak} (typ.)	635	610	586	565	557	nm
Dominantwellenlänge Dominant wavelength $I_F = 20\text{ mA}$	(typ.) λ_{dom} (typ.)	628	605	590	570	560	nm
Spektrale Bandbreite bei 50 % $I_{\text{rel max}}$ Spectral bandwidth at 50 % $I_{\text{rel max}}$ $I_F = 20\text{ mA}$	(typ.) $\Delta\lambda$ (typ.)	45	40	45	25	22	nm
Abstrahlwinkel bei 50 % I_V (Vollwinkel) Viewing angle at 50 % I_V	2ϕ	50	50	50	50	50	Grad deg.
Durchlaßspannung Forward voltage $I_F = 10\text{ mA}$	(typ.) V_F (max.) V_F	2.0 2.6	2.0 2.6	2.0 2.6	2.0 2.6	2.0 2.6	V V
Sperrstrom Reverse current $V_R = 5\text{ V}$	(typ.) I_R (max.) I_R	0.01 10	0.01 10	0.01 10	0.01 10	0.01 10	μA μA
Kapazität Capacitance $V_R = 0\text{ V}, f = 1\text{ MHz}$	(typ.) C_0	12	8	10	15	15	pF
Schaltzeiten: Switching times: I_V from 10 % to 90 % I_V from 90 % to 10 % $I_F = 100\text{ mA}, t_p = 10\text{ }\mu\text{s}, R_L = 50\text{ }\Omega$	(typ.) t_r (typ.) t_f	300 150	300 150	300 150	450 200	450 200	ns ns

Relative spektrale Emission $I_{rel} = f(\lambda)$, $T_A = 25\text{ °C}$, $I_F = 20\text{ mA}$

Relative spectral emission

$V(\lambda)$ = spektrale Augenempfindlichkeit

Standard eye response curve

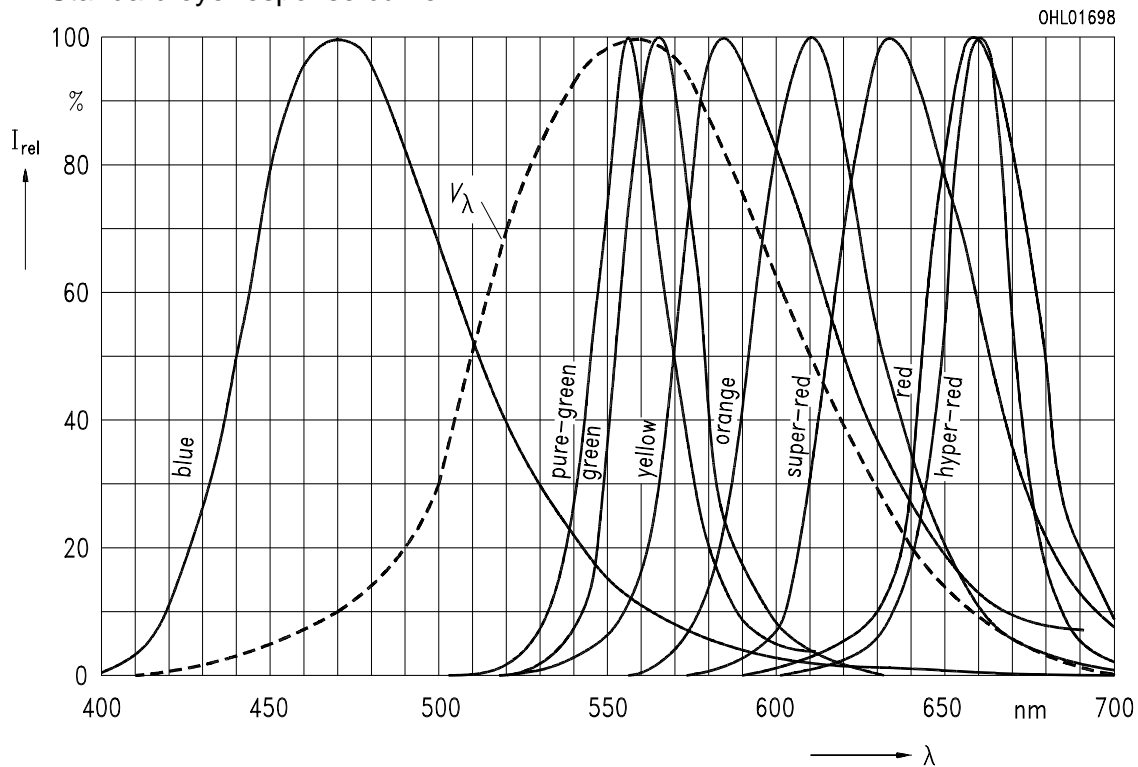

Abstrahlcharakteristik $I_{rel} = f(\varphi)$

Radiation characteristic

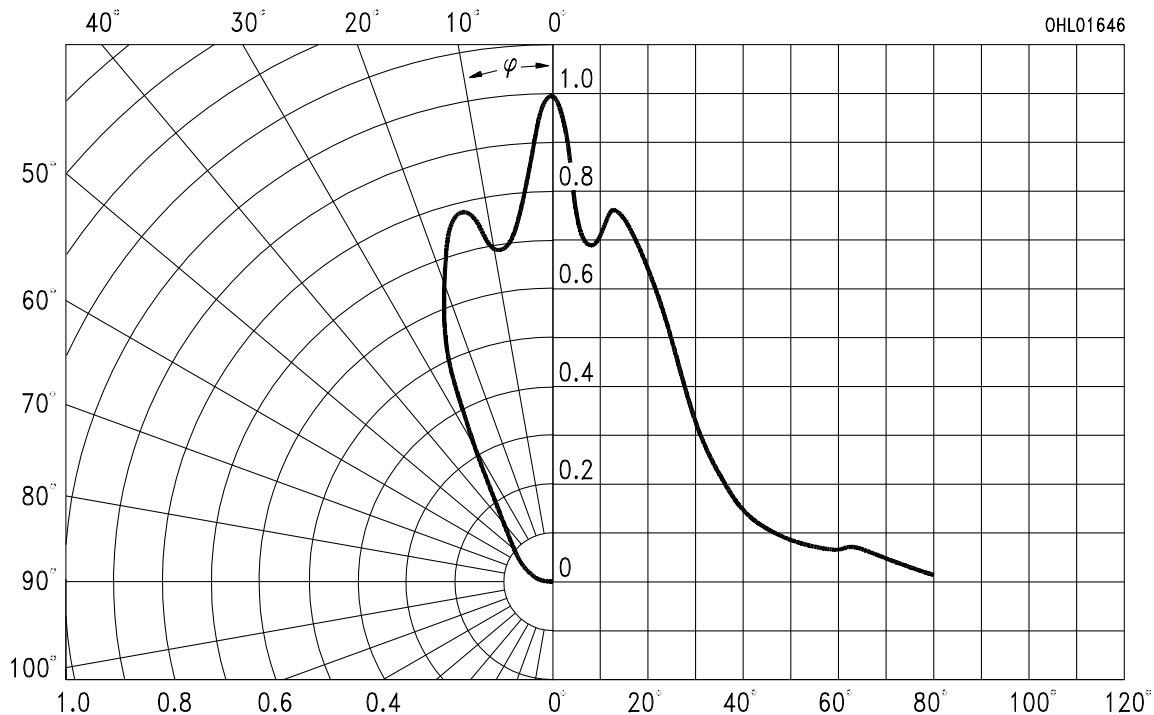

Durchlaßstrom $I_F = f(V_F)$

Forward current

$T_A = 25^\circ\text{C}$

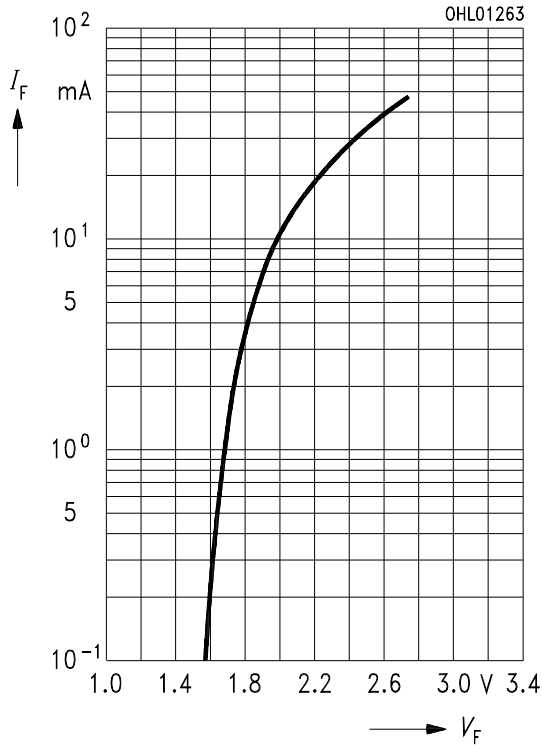

Relative Lichtstärke $I_V/I_{V(10\text{mA})} = f(I_F)$

Relative luminous intensity

$T_A = 25^\circ\text{C}$

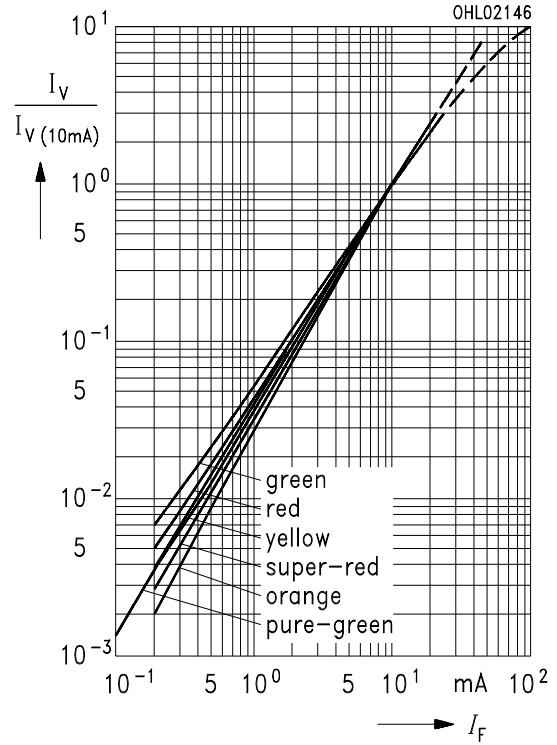

Zulässige Impulsbelastbarkeit $I_F = f(t_p)$

Permissible pulse handling capability

Duty cycle $D = \text{parameter}$, $T_A = 25^\circ\text{C}$

LS, LO, LY, LG

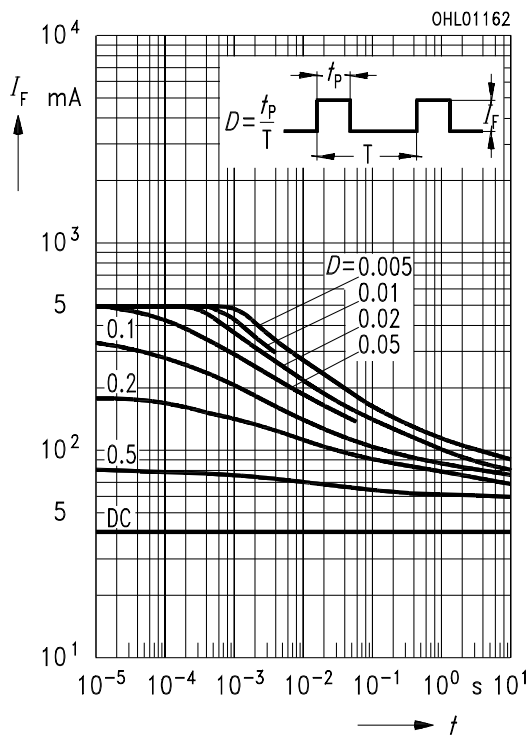

Zulässige Impulsbelastbarkeit $I_F = f(t_p)$

Permissible pulse handling capability

Duty cycle $D = \text{parameter}$, $T_A = 25^\circ\text{C}$

LP

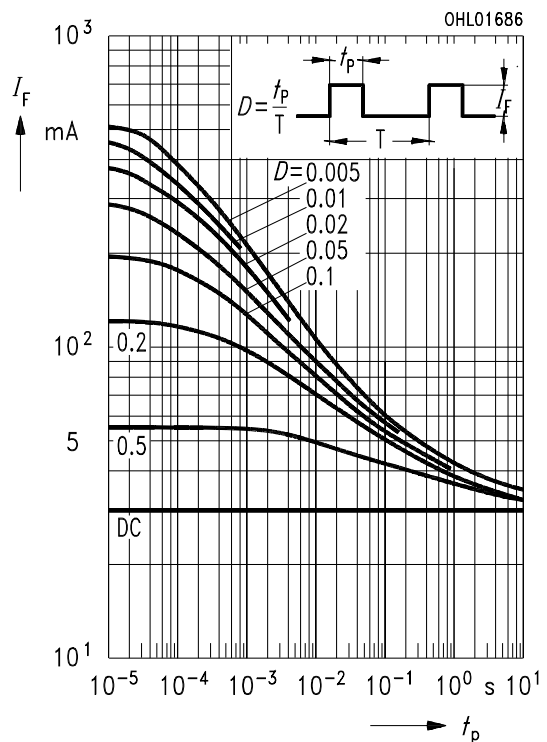

Maximal zulässiger Durchlaßstrom Max. permissible forward current

$$I_F = f(T_A)$$

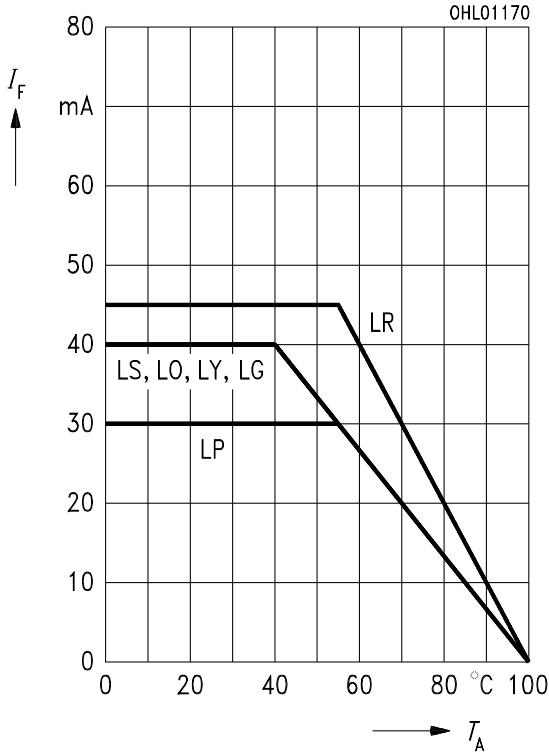

Wellenlänge der Strahlung $\lambda_{\text{peak}} = f(T_A)$ Wavelength at peak emission

$$I_F = 20 \text{ mA}$$

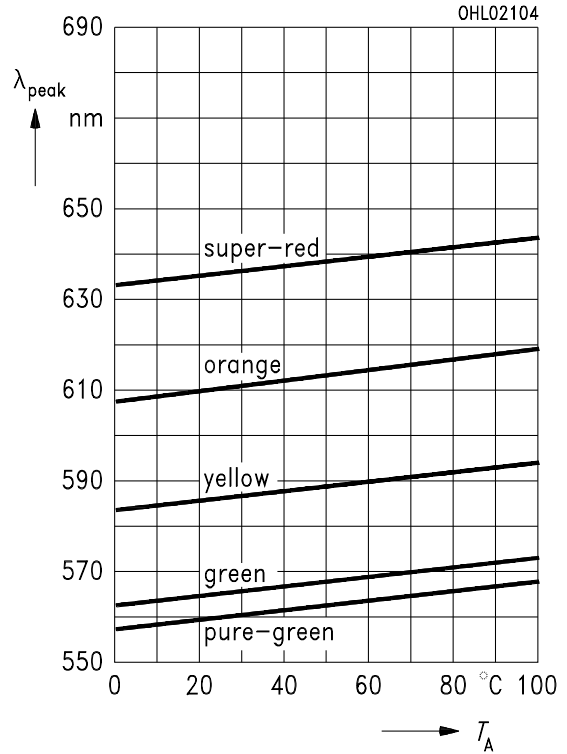

Dominantwellenlänge $\lambda_{\text{dom}} = f(T_A)$ Dominant wavelength

$$I_F = 20 \text{ mA}$$

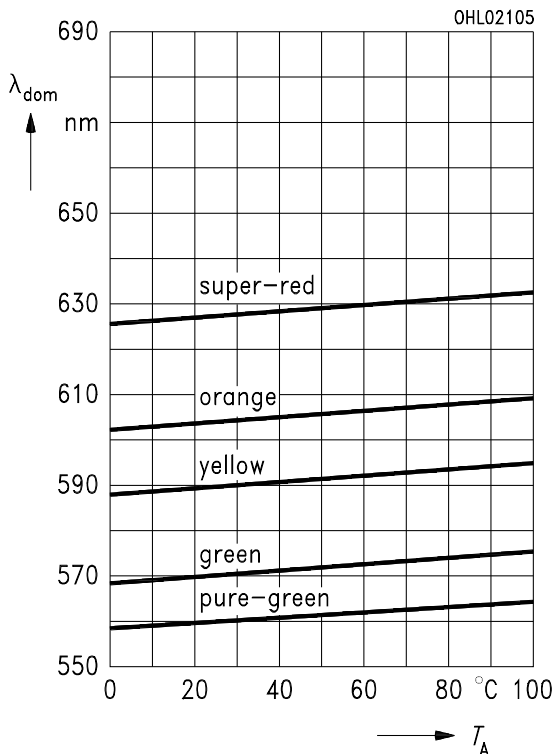

Durchlaßspannung $V_F = f(T_A)$ Forward voltage

$$I_F = 10 \text{ mA}$$

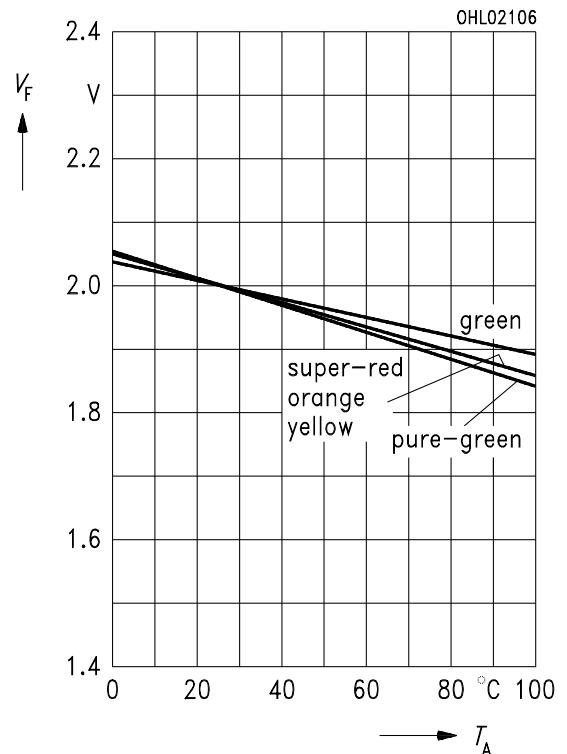

Relative Lichtstärke $I_V/I_{V(25^\circ\text{C})} = f(T_A)$
Relative luminous intensity

$I_F = 10 \text{ mA}$

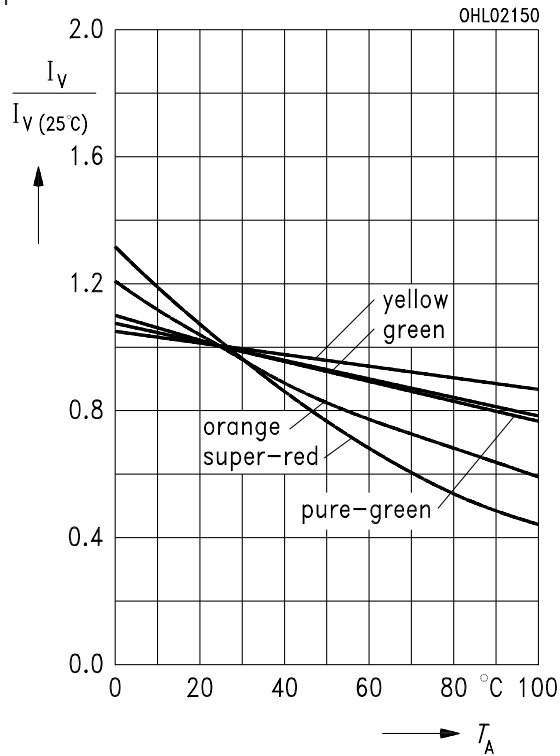

Maßzeichnung (Maße in mm, wenn nicht anders angegeben)
Package Outlines (Dimensions in mm, unless otherwise specified)

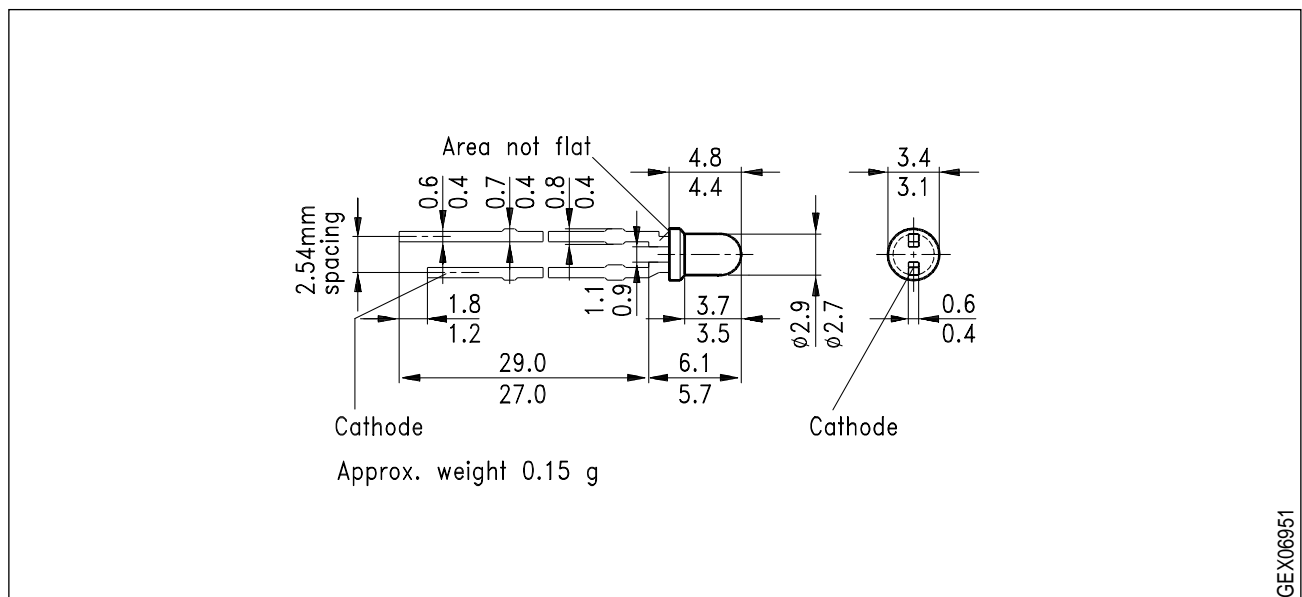

Kathodenkennzeichnung: Kürzerer Lötspieß
Cathode mark: Short solder lead