



AU OPTRONICS CORPORATION

Product Specification

17.0" SXGA Color TFT-LCD Module

Model Name: M170EG01 V.7

Approved by	Prepared by
CC Chiu	<i>Flossie Chuang</i>

DDBU Marketing Division / AU Optronics

Customer	Checked & Approved by



Product Specification

17.0" SXGA Color TFT-LCD Module Model Name: M170EG01 V.7

(◆) Preliminary Specifications
() Final Specifications

Note: This Specification is subject to change without notice.



Contents

1.0 Handling Precautions	6
2.0 General Description	8
2.1 Display Characteristics.....	8
2.2 Functional Block Diagram.....	9
2.3 Optical Characteristics	10
2.4 Pixel format image.....	13
3.0 Electrical characteristics.....	14
3.1 Absolute Maximum Ratings	14
3.2 Connectors	15
3.3 Signal Pin.....	15
3.4 Signal Description	16
3.5 Signal Electrical Characteristics	19
3.6 Interface Timings	19
3.6.1 Timing Characteristics.....	19
3.6.2 Timing Definition.....	20
3.8 Power ON/OFF Sequence	22
4.0 Backlight Characteristics	23
4.1 Signal for Lamp connector	23
4.2 Parameter guideline for CCFL Inverter	23
5.0 Vibration, Shock, and Drop	24
5.1 Vibration & Shock	24
5.2 Drop test.....	24
6.0 Environment.....	24
6.1 Temperature and Humidity	24
6.1.1 Operating Conditions.....	24
6.1.2 Shipping Conditions.....	24
6.2 Atmospheric Pressure.....	25
6.3 Thermal Shock	25
7.0 Reliability.....	25
7.1 Failure Criteria.....	25
7.2 Failure Rate	25
7.2.1 Usage	25
8.0 Safety.....	26
8.1 Sharp Edge Requirements	26
8.2 Materials.....	26
8.2.1 Toxicity.....	26



Product Specification

8.2.2 Flammability	26
8.3 Capacitors	26
9.0 Other requirement.....	27
9.1 National Test Lab Requirement	27
9.2 Label	27
10.0 Mechanical Characteristics	28



Record of Revision

Version and Date	Page	Old description	New Description	Remark
0.1 2005/2/28	All	First Edition for Customer	All	



1.0 Handling Precautions

- 1) Since front polarizer is easily damaged, pay attention not to scratch it.
- 2) Be sure to turn off power supply when inserting or disconnecting from input connector.
- 3) Wipe off water drop immediately. Long contact with water may cause discoloration or spots.
- 4) When the panel surface is soiled, wipe it with absorbent cotton or other soft cloth.
- 5) Since the panel is made of glass, it may break or crack if dropped or bumped on hard surface.
- 6) Since CMOS LSI is used in this module, take care of static electricity and insure human earth when handling.
- 7) Do not open nor modify the Module Assembly.
- 8) Do not press the reflector sheet at the back of the module to any directions.
- 9) In case if a module has to be put back into the packing container slot after once it was taken out from the container, do not press the center of the CCFL reflector edge. Instead, press at the far ends of the CCFL reflector edge softly. Otherwise the TFT module may be damaged.
- 10) At the insertion or removal of the Signal Interface Connector, be sure not to rotate nor tilt the Interface Connector of the TFT module.
- 11) After installation of the TFT module into an enclosure (Desktop monitor Bezel, for example), do not twist nor bend the TFT Module even momentary. At designing the enclosure, it should be taken into consideration that no bending/twisting forces are applied to the TFT module from outside. Otherwise the TFT module may be damaged.



2.0 General Description

This specification applies to the 17.0 inch Color TFT/LCD Module M170EG01 V7.

This module is designed for a display unit of personal computer.

The display supports the SXGA (1280(H) x 1024(V)) screen format and 16.2M colors (RGB 6-bits + FRC data).

All input signals are 2 Channel LVDS interface compatible.

This module does not contain an inverter card for backlight.

2.1 Display Characteristics

The following items are characteristics summary on the table under 25 °C condition:

ITEMS	Unit	SPECIFICATIONS				
Screen Diagonal	[mm]	432(17.0")				
Active Area	[mm]	337.920 (H) x 270.336(V)				
Pixels H x V		1280(x3) x 1024				
Pixel Pitch	[mm]	0.264 (per one triad) x 0.264				
Pixel Arrangement		R.G.B. Vertical Stripe				
Display Mode		Normally White				
White Luminance	[cd/m ²]	300 (Typ)				
Contrast Ratio		500 : 1				
Optical Rise Time/Fall Time	[msec]	12 (Typ)				
Color Saturation		72% NTSC				
Nominal Input Voltage VDD	[Volt]	+5.0 V				
Power Consumption (VDD line + CCFL line)	[Watt]	25.8 W(Typ) (PDD=6 W, PCFL=19.8 W @Lamp=7.5mA)				
Weight	[Grams]	1900 (Typ)				
Physical Size	[mm]	Min.	Typ.	Max.		
		Horizatal(H)	358	358.5	359.0	
		Vertical(V)	296	296.5	297	
		Depth(D)	16.5	17.0	17.5	
Electrical Interface		Dual Channel LVDS				
Support Color		16.2M colors (RGB 6-bit + FRC data)				
Temperature Range						
	Operating	[°C]	0 to +50			
Storage (Shipping)	[°C]	-20 to +60				



Product Specification

2.2 Functional Block Diagram

The following diagram shows the functional block of the 17.0 inches Color TFT/LCD Module:

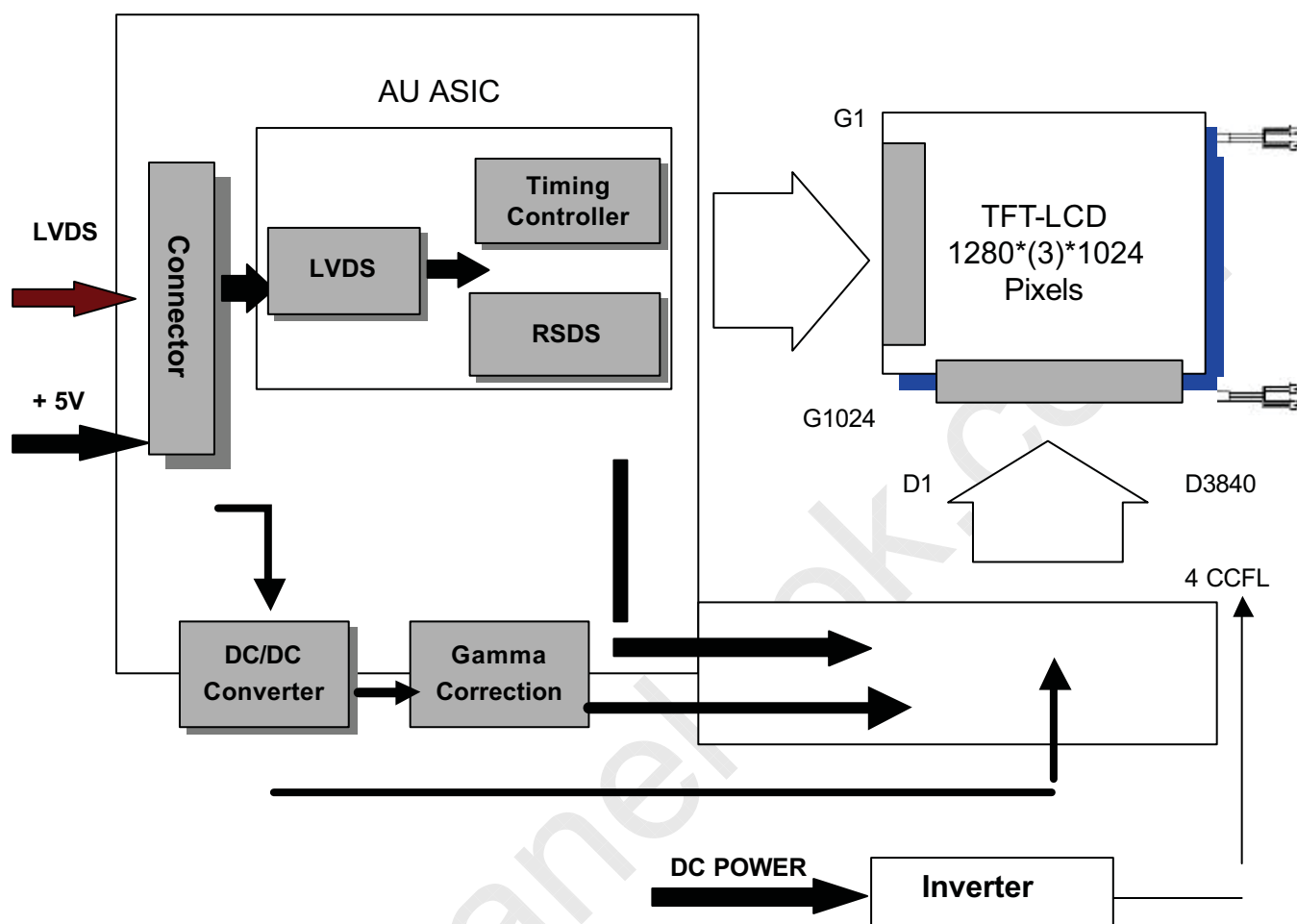

FI-XB30SRL-HF11 / MDF76LBRW-30S-1H

JST-BHSR-02VS-1 (2pin ×2)

Mating Type: JAE FI-X30C2L / HRS MDF76G-30P-1SD

SM02B-BHSS-1-TB



Product Specification

2.3 Optical Characteristics

The optical characteristics are measured under stable conditions at 25°C (Room Temperature):

Item	Unit	Conditions	Min.	Typ.	Max.	Note
Viewing Angle	[degree]	Horizontal (Right) CR = 10 (Left)	60 60	70 70		-
		Vertical (Up) CR = 10 (Down)	60 50	70 60		-
		Horizontal (Right) CR = 5 (Left)	70 70	80 80		
		Vertical (Up) CR = 5 (Down)	70 70	80 80		
Contrast ratio		Normal Direction	300	500		-
Response Time	[msec]	Rising Time	-	9	12	Note 1
		Falling Time	-	3	4	
		Rising + Falling	-	12	16	
Color / Chromaticity Coordinates (CIE)		Red x	0.61	0.64	0.67	
		Red y	0.31	0.34	0.37	
		Green x	0.26	0.29	0.32	
		Green y	0.58	0.61	0.64	
		Blue x	0.11	0.14	0.17	
		Blue y	0.04	0.07	0.10	
Color Coordinates (CIE) White		White x	0.28	0.31	0.34	
		White y	0.30	0.33	0.36	
White Luminance @ CCFL 7.5mA (center)	[cd/m ²]		250	300		-
Luminance Uniformity	[%]		75	80		Note 2
Crosstalk (in 75Hz)	[%]				1.5	Note 3
Flicker	dB				-20	Note 4

Equipment: Pattern Generator, Power Supply, Digital Voltmeter, Luminance meter

((PR 880, BM-5A / BM7, CS-1000, CA210, SR_3, EZ Contrast*, Optiscope& Westar TRD-100)

Aperture 1° with 100cm VD or 2° with 50cm viewing distance

Test Point Center (VESA point 9)

Environment < 1 lux

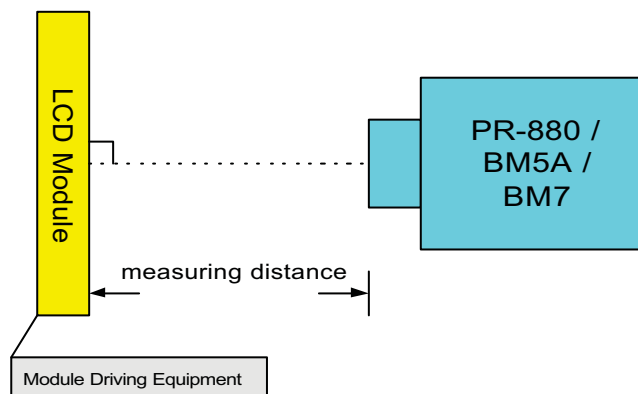

* EZ Contrast is a different measurement tool with very close viewing distance.



Product Specification

Note 1: Definition of Response time

The output signals of photodetector are measured when the input signals are changed from 'Full Black' to 'Full White' (rising time), and from 'Full White' to 'Full Black' (falling time), respectively. The response time is interval between the 10% and 90% of amplitudes.

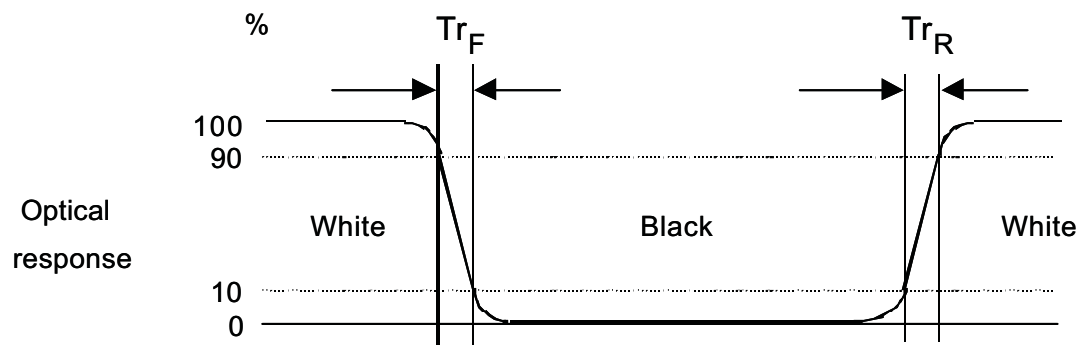

Note 2: Brightness uniformity of these 9 points is defined as below

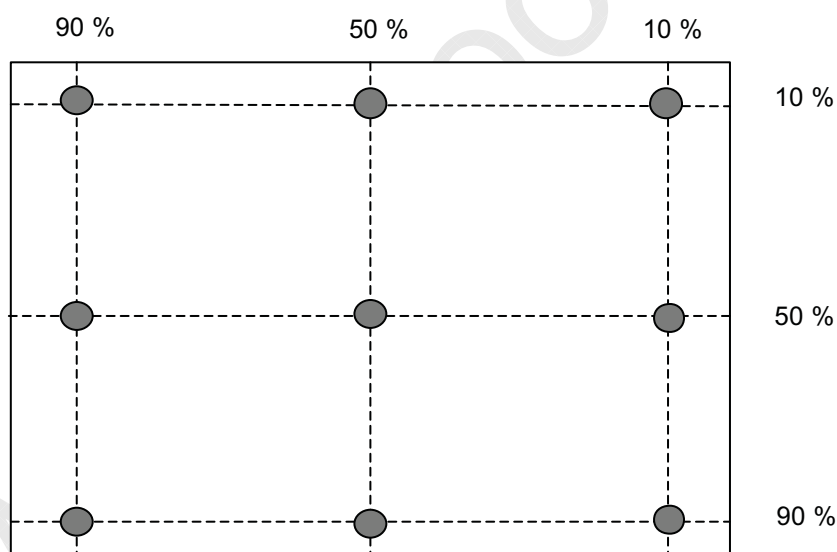

$$\text{Uniformity} = \frac{\text{Minimum Luminance in 9 points (1-9)}}{\text{Maximum Luminance in 9 Points (1-9)}}$$



Product Specification

Note 3:

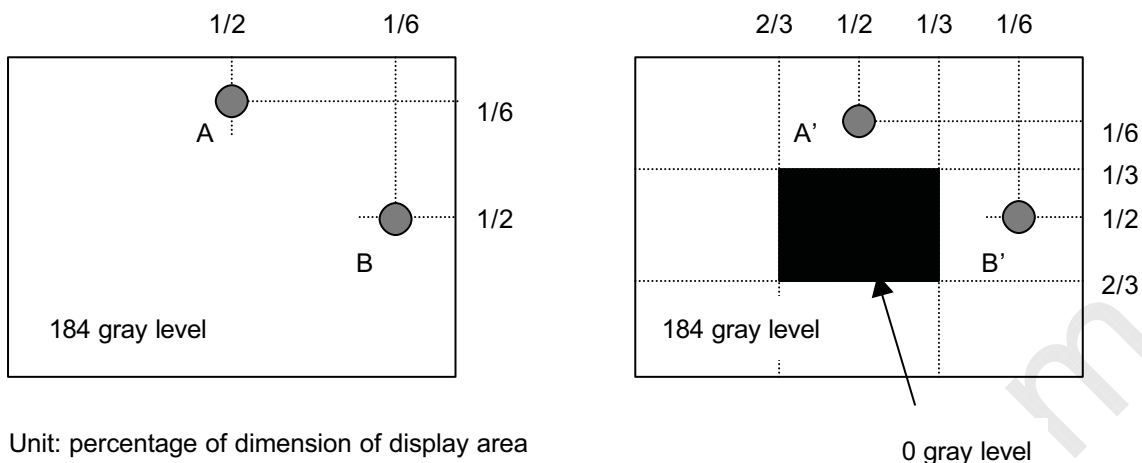

Unit: percentage of dimension of display area

$|L_A - L_{A'}| / L_A \times 100\% = 1.5\% \text{ max.}$, L_A and L_B are brightness at location A and B

$|L_B - L_{B'}| / L_B \times 100\% = 1.5\% \text{ max.}$, $L_{A'}$ and $L_{B'}$ are brightness at location A' and B'

Note4:

Test Patern : Subchecker Pattern

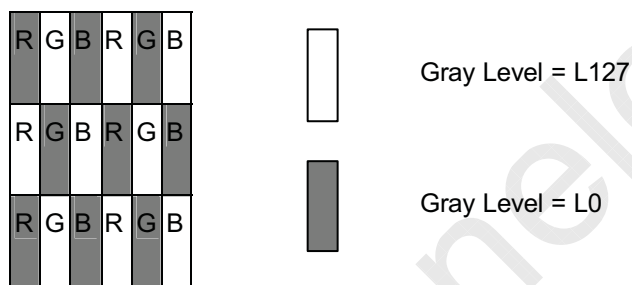

Method : Record dBV & DC value with (WESTAR)TRD-100

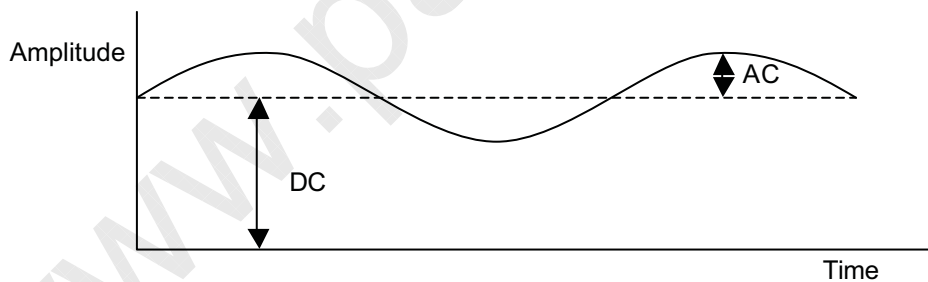

$$\text{Flicker (dB)} = 20 \log \frac{\text{AC Level(at 30 Hz)}}{\text{DC Level}}$$



2.4 Pixel format image

Following figure shows the relationship of the input signals and LCD pixel format.

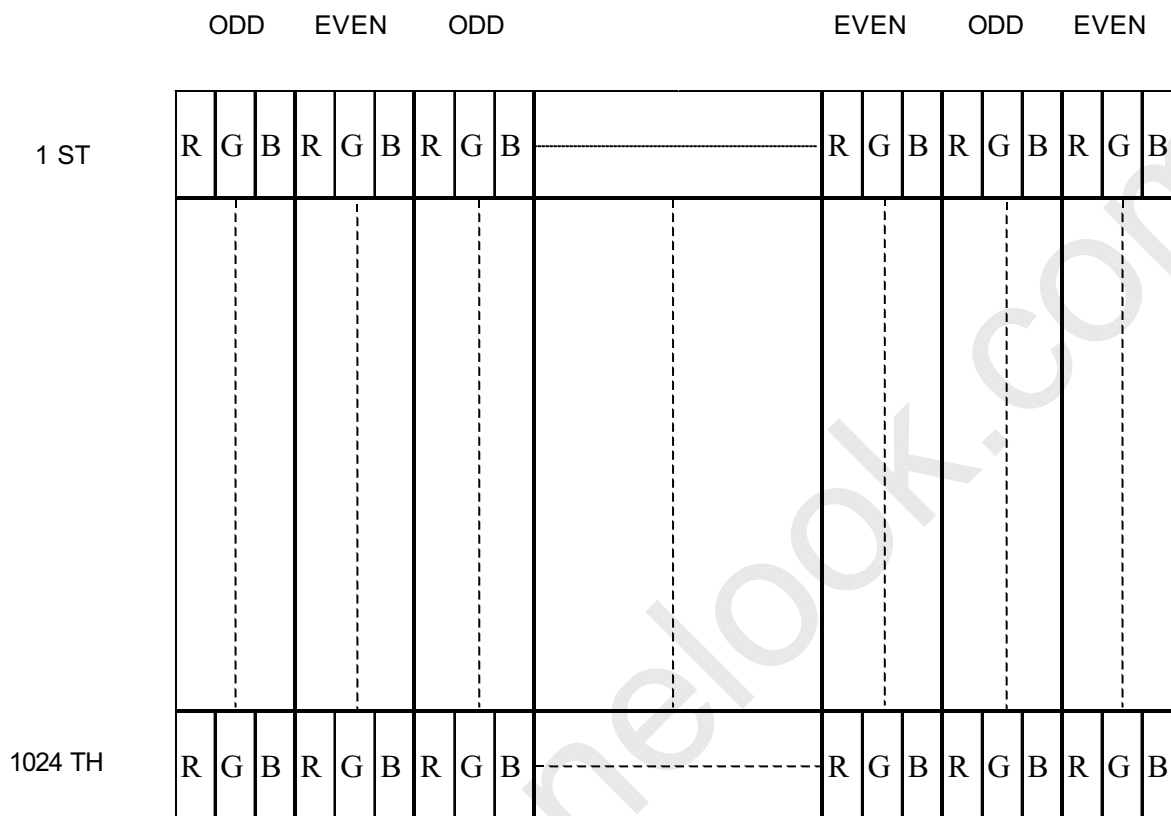



3.0 Electrical characteristics

3.1 Absolute Maximum Ratings

Absolute maximum ratings of the module is as following:

Item	Symbol	Min	Max	Unit	Conditions
Logic/LCD Drive Voltage	VIN	-0.3	6	[Volt]	
CCFL Current	ICFL	-	8.5	[mA] rms	
Operating Temperature	TOP	0	+50	[°C]	Note
Operating Humidity	HOP	5	90	[%RH]	Note
Storage Temperature	TST	-20	+60	[°C]	Note
Storage Humidity	HST	5	90	[%RH]	Note

Please refer the graph below for corresponding of Min/Max values of temperature and humidity.

Note : Maximum Wet-Bulb should be 39°C and No condensation.

Relative Humidity %

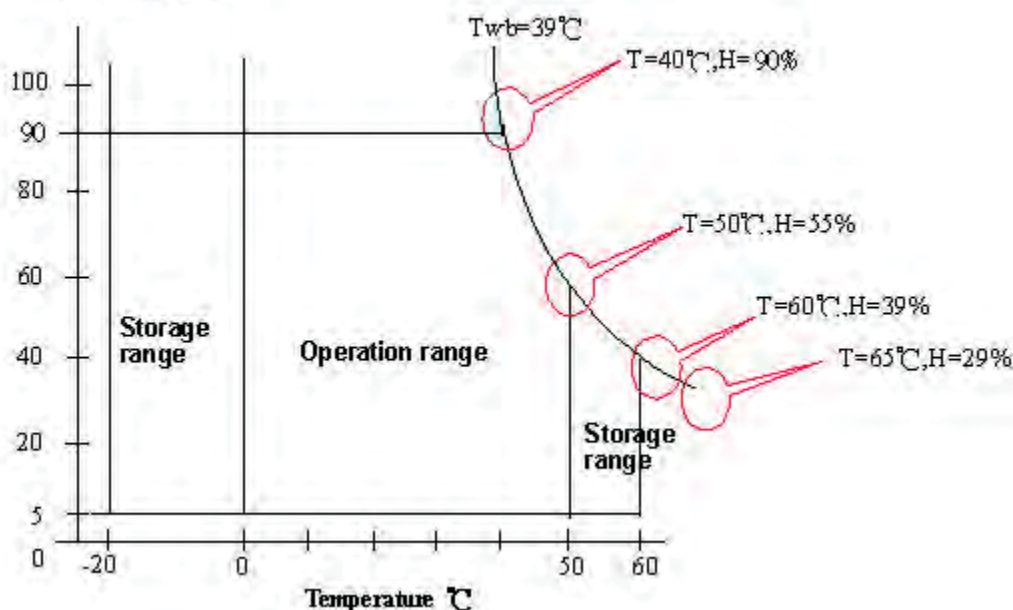



Product Specification

3.2 Connectors

Physical interface is described as for the connector on module.

These connectors are capable of accommodating the following signals and will be following components.

Connector Name / Designation	Interface Connector / Interface card
Manufacturer	JAE or compatible
Type Part Number	FI-XB30SRL-HF11 / MDF76LBRW-30S-1H
Mating Housing Part Number	JAE FI-X30C2L / HRS MDF76G-30P-1SD

Connector Name / Designation	Lamp Connector / Backlight lamp
Manufacturer	JST
Type Part Number	BHSR-02VS-1
Mating Type Part Number	SM02B-BHSS-1-TB

3.3 Signal Pin

Pin#	Signal Name	Pin#	Signal Name
1	RxOIN0-	2	RxOIN0+
3	RxOIN1-	4	RxOIN1+
5	RxOIN2-	6	RxOIN2+
7	VSS	8	RxOCLKIN-
9	RxOCLKIN+	10	RxOIN3-
11	RxOIN3+	12	RxEIN0-
13	RxEIN0+	14	VSS
15	RxEIN1-	16	RxEIN1+
17	VSS	18	RxEIN2-
19	RxEIN2+	20	RxECLKIN-
21	RxECLKIN+	22	RxEIN3-
23	RxEIN3+	24	VSS
25	VSS	26	NC
27	VSS	28	VCC
29	VCC	30	VCC



3.4 Signal Description

The module using a pair of LVDS receiver SN75LVDS82(Texas Instruments) or compatible. LVDS is a differential signal technology for LCD interface and high speed data transfer device. Transmitter shall be SN75LVDS83(negative edge sampling) or compatible. The first LVDS port(RxOxxx) transmits odd pixels while the second LVDS port(RxExxx) transmits even pixels.

PIN #	SIGNAL NAME	DESCRIPTION
1	RxOIN0-	Negative LVDS differential data input (Odd data)
2	RxOIN0+	Positive LVDS differential data input (Odd data)
3	RxOIN1-	Negative LVDS differential data input (Odd data)
4	RxOIN1+	Positive LVDS differential data input (Odd data)
5	RxOIN2-	Negative LVDS differential data input (Odd data, H-Sync, V-Sync, DSPTMG)
6	RxOIN2+	Positive LVDS differential data input (Odd data, H-Sync, V-Sync, DSPTMG)
7	VSS	Power Ground
8	RxOCLKIN-	Negative LVDS differential clock input (Odd clock)
9	RxOCLKIN+	Positive LVDS differential clock input (Odd clock)
10	RxOIN3-	Negative LVDS differential data input (Odd data)
11	RxOIN3+	Positive LVDS differential data input (Odd data)
12	RxEIN0-	Negative LVDS differential data input (Even data)
13	RxEIN0+	Positive LVDS differential data input (Even data)
14	VSS	Power Ground
15	RxEIN1-	Positive LVDS differential data input (Even data)
16	RxEIN1+	Negative LVDS differential data input (Even data)
17	VSS	Power Ground
18	RxEIN2-	Negative LVDS differential data input (Even data)
19	RxEIN2+	Positive LVDS differential data input (Even data)
20	RxECLKIN-	Negative LVDS differential clock input (Even clock)
21	RxECLKIN+	Positive LVDS differential clock input (Even clock)
22	RxEIN3-	Negative LVDS differential data input (Even data)
23	RxEIN3+	Positive LVDS differential data input (Even data)
24	VSS	Power Ground
25	VSS	Power Ground
26	NC	No Connection (for AUO test)
27	VSS	Power Ground
28	VCC	+5.0V Power Supply
29	VCC	+5.0V Power Supply
30	VCC	+5.0V Power Supply

Note1: Start from left side

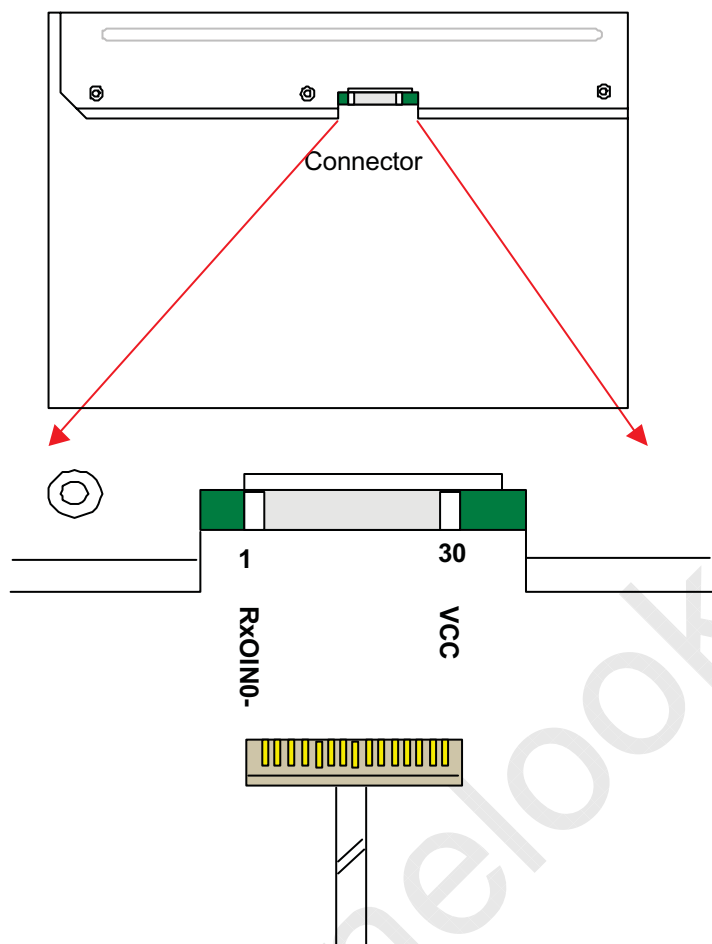

Note2: Input signals of odd and even clock shall be the same timing.

Note3: Please follow PSWG.



Product Specification

M170EG01 V.7

The input data format:

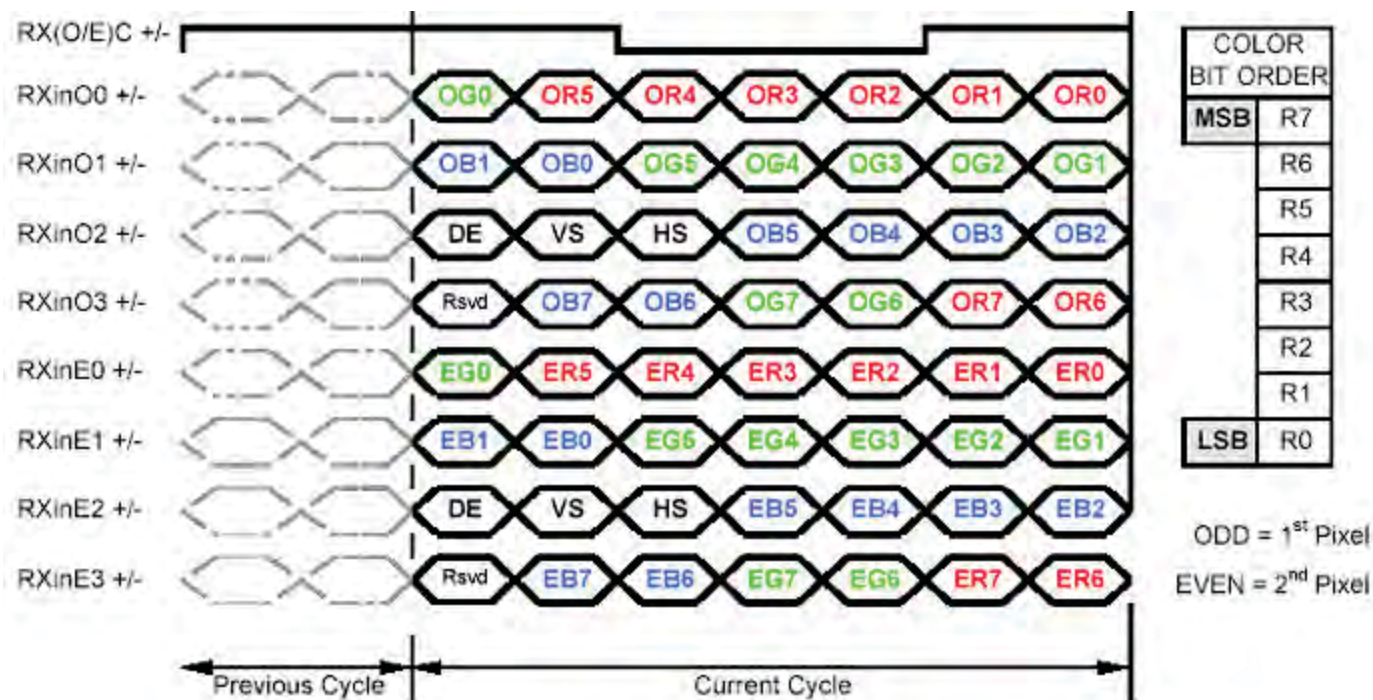

Note1: Normally, DE, VS, HS on EVEN channel are not used.

Note2: Please follow PSWG.

Note3: 8-bit in



Product Specification

3.5 Signal Electrical Characteristics

Each signal characteristics are as follows;

Symbol	Parameter	Min	Typ	Max	Units	Condition
VTH	Differential Input High Threshold	-	-	100	[mV]	VICM = 1.2V Note
VTL	Differential Input Low Threshold	-100	-	-	[mV]	VICM = 1.2V Note
VID	Input Differential Voltage	100	400	600	[mV]	Note
VICM	Differential Input Common Mode Voltage	1.1	-	1.45	[V]	VTH/VTL = $\pm 100\text{mV}$ Note

Note

LVDS Signal Waveform

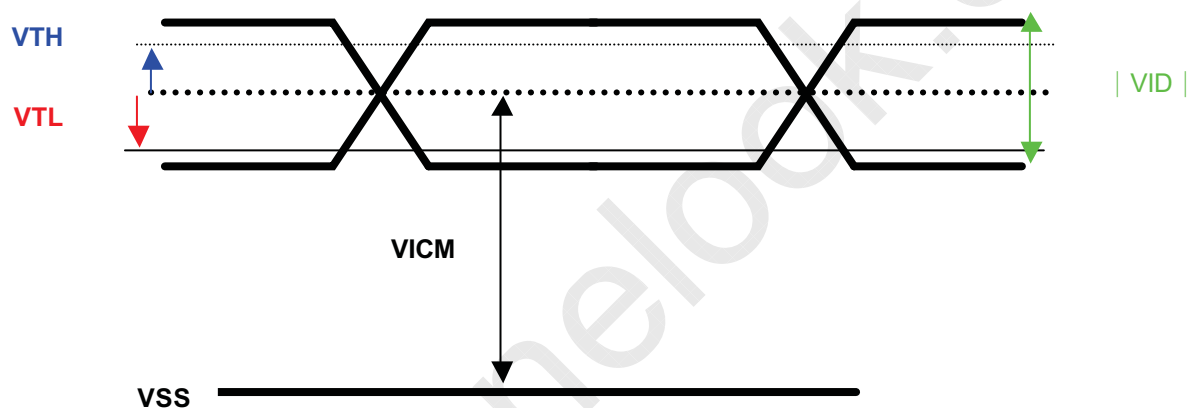

3.6 Interface Timings

3.6.1 Timing Characteristics

Item	Symbol	Min	Typ	Max	Unit
Data CLK	Tclk	40	54	70	MHz
H-section	Period	Th	685	844	Tclk
	Display Area	Tdisp(h)	640	640	Tclk
V-section	Period	Tv	1036	1066	Th
	Display Area	Tdisp(v)	1024	1024	Th
Frame Rate	F	49	60	76	Hz

Note : DE mode only

3.6.2 Timing Definition

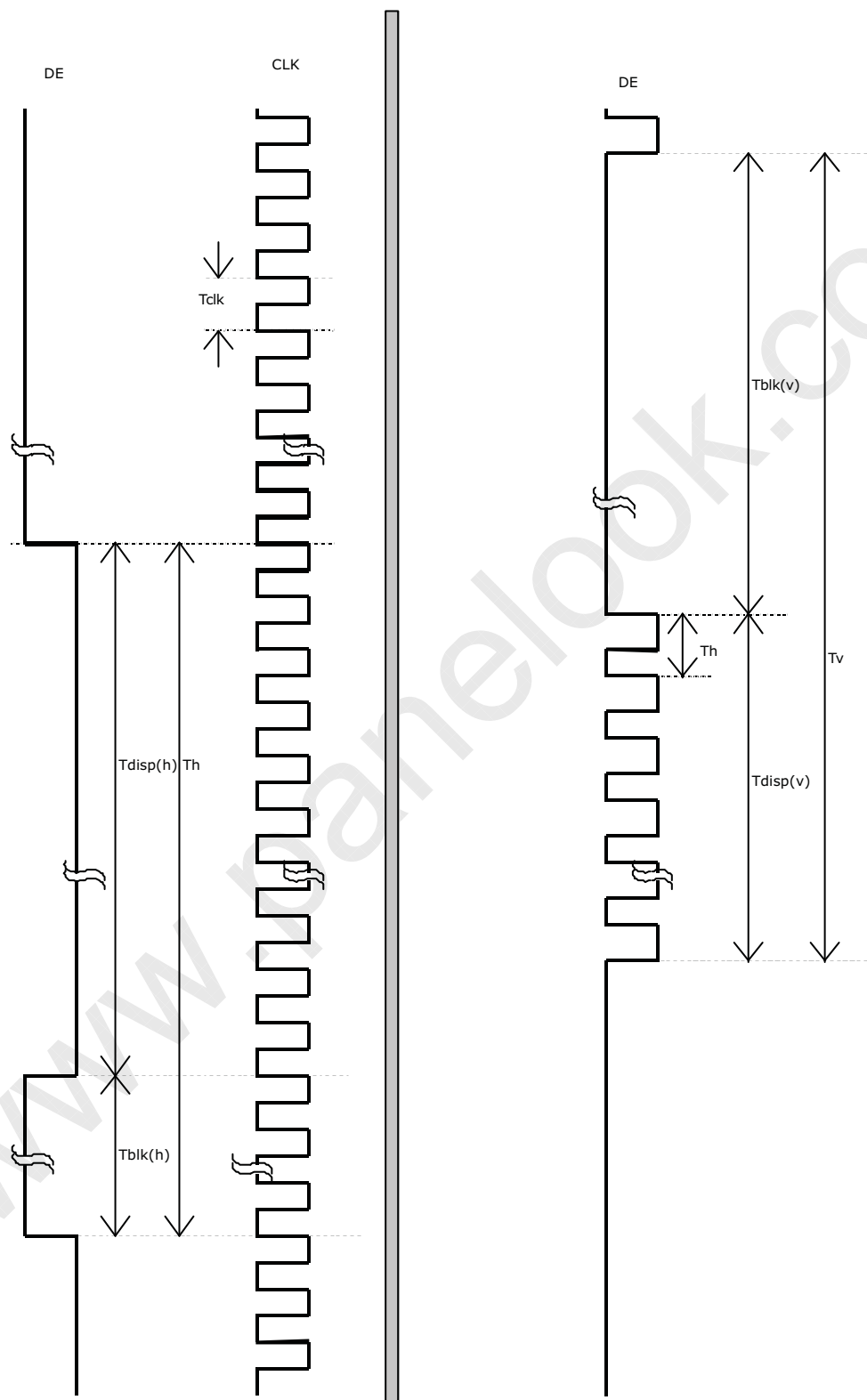



Product Specification

3.7 Power Consumption

Input power specifications are as follows;

Symbol	Parameter	Min	Typ	Max	Units	Condition
VDD	Logic/LCD Drive Voltage	4.5	5	5.5	[Volt]	± 10%
IDD	VDD current	-	1200	1560	[mA]	Vin=5V , All Black Pattern, at 75Hz
Irush	LCD Inrush Current	-	-	2.5	[A]	Note
PDD	VDD Power		6	7.8	[Watt]	Vin=5V , All Black Pattern, at 75Hz
VDDrp	Allowable Logic/LCD Drive Ripple Voltage			100	[mV] p-p	Vin=5V , All Black Pattern, at 75Hz

Note: Measurement conditions:

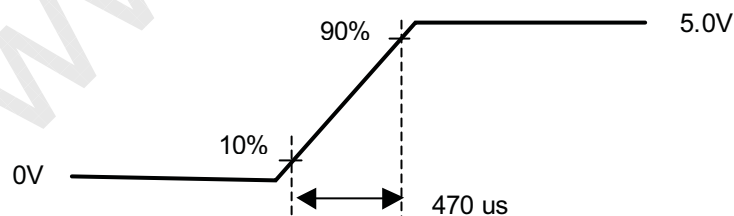
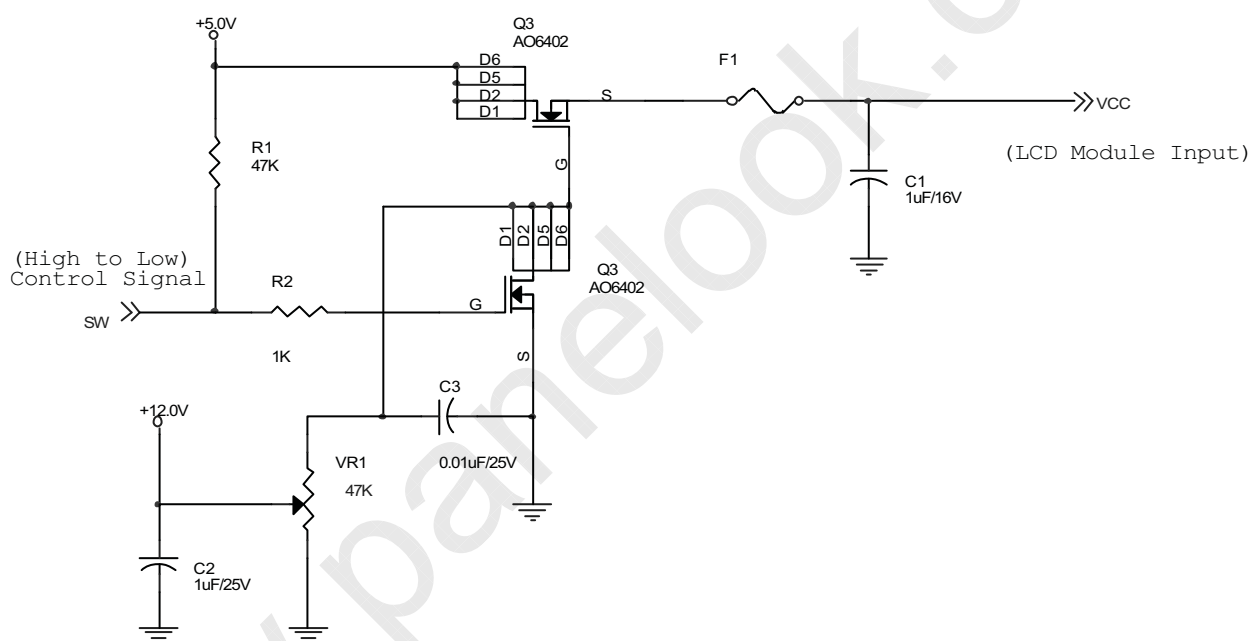

Vin rising time

3.8 Power ON/OFF Sequence

Vin and lamp power on/off sequence are as follows. The timing parameters of interface signal are shown in the table below. The signal please reference "3.4 Signal Description".

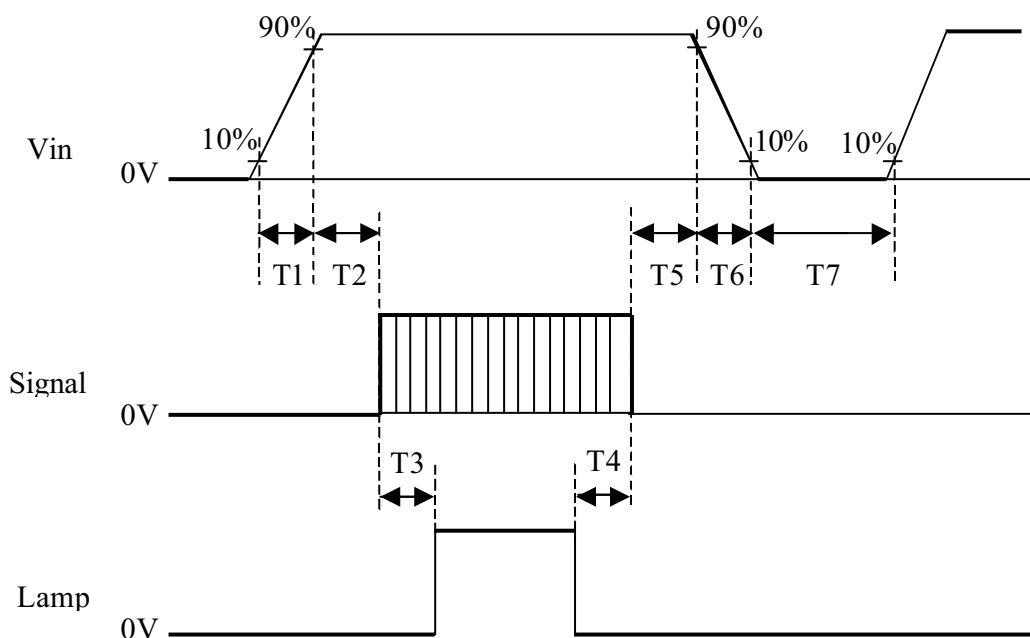

Symbol	Values			Unit
	Min.	Typ.	Max.	
T1	0.5	-	10	ms
T2	0	-	10	ms
T3	200	-	-	ms
T4	100	-	-	ms
T5	0	16	50	ms
T6	-	-	10	ms
T7	1000	-	-	ms

Note: The values of the table are follow PSWG.



4.0 Backlight Characteristics

4.1 Signal for Lamp connector

	Connector No.	Pin No.	Input	Color	Function
Upper	CN1	1	Hot1	Pink	High Voltage
		2	Cold1	White	Low Voltage
	CN2	1	Hot2	Blue	High Voltage
		2	Cold2	Black	Low Voltage
Lower	CN3	1	Hot1	Pink	High Voltage
		2	Cold1	White	Low Voltage
	CN4	1	Hot2	Blue	High Voltage
		2	Cold2	Black	Low Voltage

4.2 Parameter guideline for CCFL Inverter

Symbol	Parameter	Min.	Typ.	Max.	Unit	Condition
ISCFL	CCFL standard current	7.0	7.5	8.0	[mA] rms	(Ta=25°C) Note 1
IRCFL	CCFL operation range	3.0	7.5	8.0	[mA] rms	(Ta=25°C)
FCFL	CCFL Frequency	40	60	80	[KHz]	(Ta=25°C) Note 2
ViCFL (0°C)	CCFL Ignition Voltage (End of the lamp wire connector)	1500	-	-	[Volt] rms	(Ta=0°C)
ViCF (25°C)	CCFL Ignition Voltage (End of the lamp wire connector)	1150	-	-	[Volt] rms	(Ta=25°C)
VCFL	CCFL Operation Voltage	-	660 @7.5mA	700 @3.0mA	[Volt] rms	(Ta=25°C) Note 1
PCFL	CCFL Power consumption (for reference)	-	19.8	21.8	[Watt]	(Ta=25°C) Note 3
LTCFL	CCFL life Time	30,000	50,000	-	[Hour]	(Ta=25°C) Note 4

Note 1: CCFL standard current is measured at 25±2°C.

Note 2: CCFL Frequency should be carefully determined to avoid interference between inverter and TFT LCD

Note 3: The variance of CCFL power consumption is ±10%. Calculator value for reference (ICFL×VCFL×4=PCFL).

Note 4: CCFL life time is determined as the time at which brightness of lamp is 50%. The typical life time of CCFL is on the condition at 7.5 mA lamp current.



5.0 Vibration, Shock, and Drop

5.1 Vibration & Shock

Vibration Test Spec:

- Frequency: 10 - 200Hz
- Sweep: 30 Minutes each Axis (X, Y, Z)
- Acceleration: 1.5G(10~200Hz P- P)
- Test method:

Acceleration (G)	1.5
Frequency (Hz)	10~200~10
Active time (min)	30

Shock Test Spec:

Acceleration (G) -a	50
Active time -b	20 ms
Wave form	Half-sin
Times	1

- Direction: $\pm X$, $\pm Y$, $\pm Z$

5.2 Drop test

Package test: The drop height is 60cm.

6.0 Environment

The display module will meet the provision of this specification during operating condition or after storage or shipment condition specified below. Operation at 10% beyond the specified range will not cause physical damage to the unit.

6.1 Temperature and Humidity

6.1.1 Operating Conditions

The display module operates error free, when operated under the following conditions;

Temperature	0 °C to 50 °C
Relative Humidity	8% to 95%
Wet Bulb Temperature	39.0 °C

6.1.2 Shipping Conditions

The display module operates error free, after the following conditions;

Temperature	-20 °C to 60 °C
Relative Humidity	5% to 100%
Wet Bulb Temperature	39.0 °C



Product Specification

6.2 Atmospheric Pressure

The display assembly is capable of being operated without affecting its operations over the pressure range as following specified;

	Pressure	Note
Maximum Pressure	1040hPa	(sea level)
Minimum Pressure	674hPa	(3048m)

6.3 Thermal Shock

The display module will not sustain damage after being subjected to 100 cycles of rapid temperature change. A cycle of rapid temperature change consists of varying the temperature from -20°C to 60°C, and back again.

Thermal shock cycle -20 °C for 30min
 60 °C for 30min

Power is not applied during the test. After temperature cycling, the unit is placed in normal room ambient for at least 4 hours before powering on.

7.0 Reliability

This display module and the packaging of that will comply following standards.

7.1 Failure Criteria

The display assembly will be considered as failing unit when it no longer meets any of the requirements stated in this specification. Only as for maximum white luminance, following criteria is applicable.

- **Maximum white Luminance shall be 150cd/m² or more.**

7.2 Failure Rate

The average failure rate of the display module (from first power-on cycle till 1,000 hours later) will not exceed 1.0%. The average failure rate of the display module from 1,000 hours until 16,000 hours will not exceed 0.7% per 1000 hours.

7.2.1 Usage

The assumed usage for the above criteria is:

- 220 power-on hours per month
- 500 power on/off cycles per month
- Maximum brightness setting
- Operation to be within office environment (25°C typical)



8.0 Safety

8.1 Sharp Edge Requirements

There will be no sharp edges or comers on the display assembly that could cause injury.

8.2 Materials

8.2.1 Toxicity

There will be no carcinogenic materials used anywhere in the display module. If toxic materials are used, they will be reviewed and approved by the responsible ADT Toxicologist.

8.2.2 Flammability

All components including electrical components that do not meet the flammability grade UL94-V1 in the module will complete the flammability rating exception approval process.

The printed circuit board will be made from material rated 94-V1 or better. The actual UL flammability rating will be printed on the printed circuit board.

8.3 Capacitors

If any polarized capacitors are used in the display assembly, provisions will be made to keep them from being inserted backwards.



Product Specification

9.0 Other requirement

9.1 National Test Lab Requirement

The display module will satisfy all requirements for compliance to

UL 1950, First Edition

CSA C22.2 No.950-M89

EEC 950

EN 60 950

U.S.A. Information Technology Equipment

Canada, Information Technology Equipment

International, Information Technology Equipment

International, Information Processing Equipment

(European Norm for IEC950)

9.2 Label

The label is on the panel as shown below:

