



# Product Specification

M185XTN01.2

AU OPTRONICS CORPORATION

( V ) Preliminary Specification

( ) Final Specification

<b>Module</b>	18.5" Color TFT-LCD
<b>Model Name</b>	M185XTN01.2

<b>Customer</b>	<b>Date</b>
_____	_____
<b>Approved by</b>	
_____	_____

<b>Approved by</b>	<b>Date</b>
<i>Chiyin Wu</i>	_____
<b>Prepared by</b>	
<i>Glenn Chan</i>	2012/5/9

Note: This Specification is subject to change without notice.

Desktop Display Business Group /  
AU Optronics corporation

## Contents

<b>1.0 Handling Precautions.....</b>	<b>4</b>
<b>2.0 General Description .....</b>	<b>5</b>
2.1 Display Characteristics .....	5
2.2 Optical Characteristics.....	6
2.3 Mechanical Characteristics .....	10
<b>3.0 Functional Block Diagram .....</b>	<b>11</b>
<b>4.0 Absolute Maximum Ratings .....</b>	<b>12</b>
4.1 TFT LCD Module .....	12
4.2 Backlight Unit .....	12
4.3 Absolute Ratings of Environment.....	12
<b>5.0 Electrical characteristics .....</b>	<b>14</b>
5.1 TFT LCD Module .....	14
<b>5.1.1 Power Specification.....</b>	<b>14</b>
<b>5.1.2 Signal Electrical Characteristics .....</b>	<b>15</b>
5.2 Backlight Unit .....	17
<b>6.0 Signal Characteristic.....</b>	<b>18</b>
6.1 Pixel Format Image .....	18
6.2 The input data format.....	18
6.3 Signal Description .....	19
6.4 Timing Characteristics .....	21
6.5 Timing diagram .....	22
6.6 Power ON/OFF Sequence.....	23
<b>7.0 Connector &amp; Pin Assignment.....</b>	<b>24</b>
7.1 TFT LCD Module .....	24
<b>7.1.1 Pin Assignment .....</b>	<b>24</b>
7.2 LED Connector on Backlight Unit.....	25
<b>7.2.1 LED Pin assignment.....</b>	<b>25</b>
<b>7.2.2 LED Connector dimension.....</b>	<b>26</b>
<b>7.2.3 LED Mating housing dimension.....</b>	<b>26</b>
<b>8.0 Reliability Test.....</b>	<b>27</b>
<b>9.0 Shipping Label .....</b>	<b>28</b>
<b>10.0 Mechanical Characteristics.....</b>	<b>29</b>
<b>11. Packing Specification.....</b>	<b>30</b>

## Record of Revision

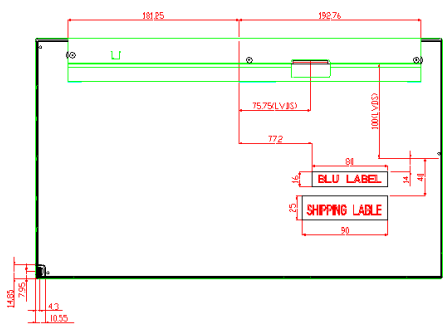
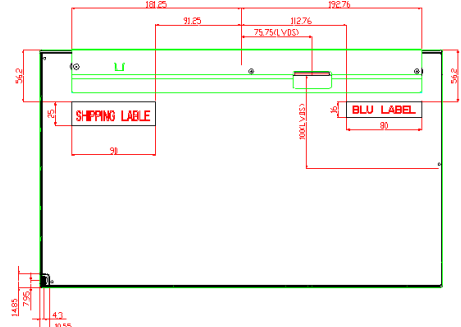
Version and Date	Page	Old description	New Description	Remark																																																
0.1 2012/05/09		Preliminary Version																																																		
0.2 2012/6/18	31	Update label positions. 																																																		
	13	Logic/LCD Drive Voltage VDD: +5.5V	Logic/LCD Drive Voltage VDD: +6.0V																																																	
	15	5.1.1 Power specification Irush Max. :2A	5.1.1 Power specification Irush Max. : TBD																																																	
	22	6.4 Timing characteristics Clock: Max. 90 MHz	6.4 Timing characteristics Clock: Max. 94 MHz																																																	
0.3 2012/7/4	6	“Energy Star 6.0 Compliance” : Yes	Remove “Energy Star 6.0 Compliance” because it’ll be tested not with panel only but completed set.																																																	
	27	Altitude test: Operation 15,000ft	Altitude test: Operation 18,000ft																																																	
0.3 2012/7/9	6	Color / Chromaticity Coordinates (CIE) <table border="1" data-bbox="367 1736 518 1848"> <tr><td>Red x<sup>o</sup></td><td>TBD<sup>o</sup></td><td>TBD<sup>o</sup></td><td>TBD<sup>o</sup></td></tr> <tr><td>Red y<sup>o</sup></td><td>TBD<sup>o</sup></td><td>TBD<sup>o</sup></td><td>TBD<sup>o</sup></td></tr> <tr><td>Green x<sup>o</sup></td><td>TBD<sup>o</sup></td><td>TBD<sup>o</sup></td><td>TBD<sup>o</sup></td></tr> <tr><td>Green y<sup>o</sup></td><td>TBD<sup>o</sup></td><td>TBD<sup>o</sup></td><td>TBD<sup>o</sup></td></tr> <tr><td>Blue x<sup>o</sup></td><td>TBD<sup>o</sup></td><td>TBD<sup>o</sup></td><td>TBD<sup>o</sup></td></tr> <tr><td>Blue y<sup>o</sup></td><td>TBD<sup>o</sup></td><td>TBD<sup>o</sup></td><td>TBD<sup>o</sup></td></tr> </table>	Red x <sup>o</sup>	TBD <sup>o</sup>	TBD <sup>o</sup>	TBD <sup>o</sup>	Red y <sup>o</sup>	TBD <sup>o</sup>	TBD <sup>o</sup>	TBD <sup>o</sup>	Green x <sup>o</sup>	TBD <sup>o</sup>	TBD <sup>o</sup>	TBD <sup>o</sup>	Green y <sup>o</sup>	TBD <sup>o</sup>	TBD <sup>o</sup>	TBD <sup>o</sup>	Blue x <sup>o</sup>	TBD <sup>o</sup>	TBD <sup>o</sup>	TBD <sup>o</sup>	Blue y <sup>o</sup>	TBD <sup>o</sup>	TBD <sup>o</sup>	TBD <sup>o</sup>	Color / Chromaticity Coordinates (CIE) <table border="1" data-bbox="837 1736 989 1848"> <tr><td>Red x<sup>o</sup></td><td>0.616</td><td>0.646</td><td>0.676</td></tr> <tr><td>Red y<sup>o</sup></td><td>0.303</td><td>0.333</td><td>0.363</td></tr> <tr><td>Green x<sup>o</sup></td><td>0.287</td><td>0.317</td><td>0.347</td></tr> <tr><td>Green y<sup>o</sup></td><td>0.595</td><td>0.625</td><td>0.655</td></tr> <tr><td>Blue x<sup>o</sup></td><td>0.124</td><td>0.154</td><td>0.184</td></tr> <tr><td>Blue y<sup>o</sup></td><td>0.031</td><td>0.061</td><td>0.091</td></tr> </table>	Red x <sup>o</sup>	0.616	0.646	0.676	Red y <sup>o</sup>	0.303	0.333	0.363	Green x <sup>o</sup>	0.287	0.317	0.347	Green y <sup>o</sup>	0.595	0.625	0.655	Blue x <sup>o</sup>	0.124	0.154	0.184	Blue y <sup>o</sup>	0.031	0.061	0.091	
Red x <sup>o</sup>	TBD <sup>o</sup>	TBD <sup>o</sup>	TBD <sup>o</sup>																																																	
Red y <sup>o</sup>	TBD <sup>o</sup>	TBD <sup>o</sup>	TBD <sup>o</sup>																																																	
Green x <sup>o</sup>	TBD <sup>o</sup>	TBD <sup>o</sup>	TBD <sup>o</sup>																																																	
Green y <sup>o</sup>	TBD <sup>o</sup>	TBD <sup>o</sup>	TBD <sup>o</sup>																																																	
Blue x <sup>o</sup>	TBD <sup>o</sup>	TBD <sup>o</sup>	TBD <sup>o</sup>																																																	
Blue y <sup>o</sup>	TBD <sup>o</sup>	TBD <sup>o</sup>	TBD <sup>o</sup>																																																	
Red x <sup>o</sup>	0.616	0.646	0.676																																																	
Red y <sup>o</sup>	0.303	0.333	0.363																																																	
Green x <sup>o</sup>	0.287	0.317	0.347																																																	
Green y <sup>o</sup>	0.595	0.625	0.655																																																	
Blue x <sup>o</sup>	0.124	0.154	0.184																																																	
Blue y <sup>o</sup>	0.031	0.061	0.091																																																	

--	--	--	--	--

## 1.0 Handling Precautions

- 1) Since front polarizer is easily damaged, pay attention not to scratch it.
- 2) Be sure to turn off power supply when inserting or disconnecting from input connector.
- 3) Wipe off water drop immediately. Long contact with water may cause discoloration or spots.
- 4) When the panel surface is soiled, wipe it with absorbent cotton or other soft cloth.
- 5) Since the panel is made of glass, it may break or crack if dropped or bumped on hard surface.
  
- 6) Since CMOS LSI is used in this module, take care of static electricity and insure human earth when handling.
- 7) Do not open or modify the Module Assembly.
- 8) Do not press the reflector sheet at the back of the module to any directions.
- 9) In case if a Module has to be put back into the packing container slot after once it was taken out from the container, do not press the center of the LED lightbar edge. Instead, press at the far ends of the LED light bar edge softly. Otherwise the TFT Module may be damaged.
- 10) At the insertion or removal of the Signal Interface Connector, be sure not to rotate nor tilt the Interface Connector of the TFT Module.
- 11) After installation of the TFT Module into an enclosure, do not twist nor bend the TFT Module even momentary. At designing the enclosure, it should be taken into consideration that no bending/twisting forces are applied to the TFT Module from outside. Otherwise the TFT Module may be damaged.
- 12) Small amount of materials having no flammability grade is used in the LCD module. The LCD module should be supplied by power complied with requirements of Limited Power Source (IEC60950 or UL1950), or be applied exemption.
- 13) Please avoid touching COF contact while handling or fitting the TFT module into your system.
- 14) When storing modules as spares for a long time, the following precaution is necessary:  
Store them in a dark place. Do not expose the module to sunlight or fluorescent light. Keep the temperature between 5°C and 35°C at normal humidity.

## 2.0 General Description

This specification applies to the 18.5 inch-wide Color a-Si TFT-LCD Module M185XW01. The display supports the WXGA - 1366(H) x 768(V) screen format and 16.7M colors (RGB 6-bits + Hi-FRC data). All input signals are 1-channel LVDS interface and this module doesn't contain an inverter board for backlight.

## 2.1 Display Characteristics

The following items are characteristics summary on the table under 25°C condition:

ITEMS	Unit	SPECIFICATIONS
Screen Diagonal	[mm]	470.1(18.51")
Active Area	[mm]	409.8 (H) x 230.4 (V)
Pixels H x V		1366(x3) x 768
Pixel Pitch	[um]	300 (per one triad) x 300
Pixel Arrangement		R.G.B. Vertical Stripe
Display Mode		TN Mode, Normally White
White Luminance ( Center )	[cd/m <sup>2</sup> ]	250 cd/m <sup>2</sup> (Typ.)
Contrast Ratio		1000 (Typ.)
Optical Response Time	[msec]	5ms (Typ., on/off)
Nominal Input Voltage VDD	[Volt]	+5.0 V (Typ)
Power Consumption (VDD line + LED line)	[Watt]	VDD line: PDD (typ)= 1.75W, All black pattern at 60Hz LED line : PBLU (typ) = 7.2W Total: 8.95W
Weight	[Grams]	1290 (Typ)
Physical Size	[mm]	430.4 (W) x 254.6 (H) Typ. x 9.9 (D) Typ
Interface		One channel LVDS
Support Color		16.7M colors (RGB 6-bit + Hi_FRC )
Surface Treatment		Anti-Glare, 3H
Temperature Range		
Operating	[°C]	0 to +50
Storage (Shipping)	[°C]	-20 to +60
TCO6.0 Compliance		Yes

## 2.2 Optical Characteristics

The optical characteristics are measured under stable conditions at 25°C:

Item	Unit	Conditions	Min.	Typ.	Max.	Note
Viewing Angle	[degree]	Horizontal (Right) CR = 10 (Left)	75 75	85 85	- -	<b>2</b>
		Vertical (Up) CR = 10 (Down)	70 70	80 80	- -	
Contrast ratio		Normal Direction	600	1000	-	<b>3</b>
Response Time	[msec]	Raising Time (T <sub>rR</sub> )	-	3.6	-	<b>4</b>
		Falling Time (T <sub>rF</sub> )	-	1.4	-	
		Raising + Falling	-	5	-	
Color / Chromaticity Coordinates (CIE)		Red x	0.616	0.646	0.676	<b>5</b>
		Red y	0.303	0.333	0.363	
		Green x	0.287	0.317	0.347	
		Green y	0.595	0.625	0.655	
		Blue x	0.124	0.154	0.184	
		Blue y	0.031	0.061	0.091	
Color Coordinates (CIE) White		White x	0.283	0.313	0.343	
		White y	0.299	0.329	0.359	
Central Luminance	[cd/m <sup>2</sup> ]		200	250	-	<b>6</b>
Luminance Uniformity	[%]		75	80	-	<b>7</b>
Crosstalk (in 60Hz)	[%]				1.5	<b>8</b>
Flicker	dB				-20	<b>9</b>

**Note 1: Measurement method**

The LCD module should be stabilized at given temperature for 30 minutes to avoid abrupt temperature change during measuring (at surface 35°C). In order to stabilize the luminance, the measurement should be executed after lighting Backlight for 30 minutes in a stable, windless and dark room.

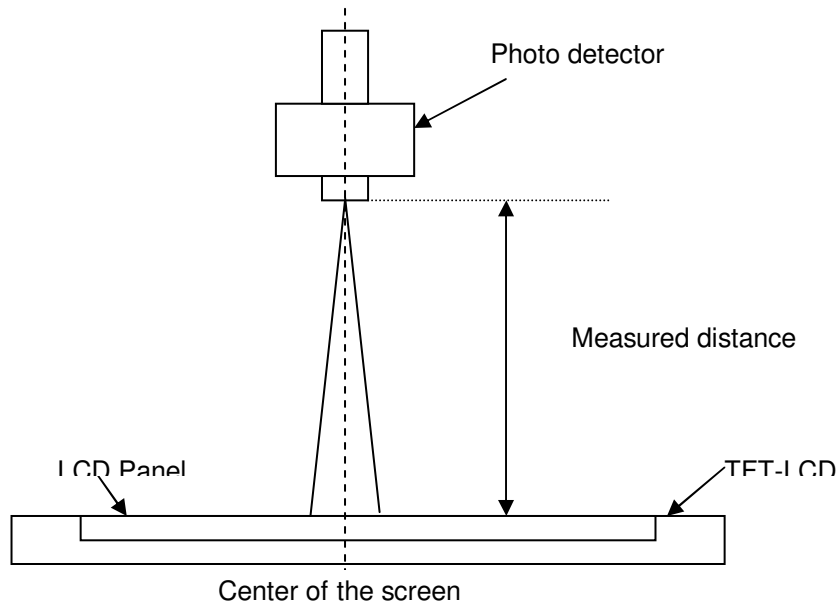

**Note 2: Definition of viewing angle** measured by ELDIM (EZContrast 88)

Viewing angle is the measurement of contrast ratio  $\geq 10$ , at the screen center, over a 180° horizontal and 180° vertical range (off-normal viewing angles). The 180° viewing angle range is broken down as follows; 90° ( $\theta$ ) horizontal left and right and 90° ( $\Phi$ ) vertical, high (up) and low (down). The measurement direction is typically perpendicular to the display surface with the screen rotated about its center to develop the desired measurement viewing angle.

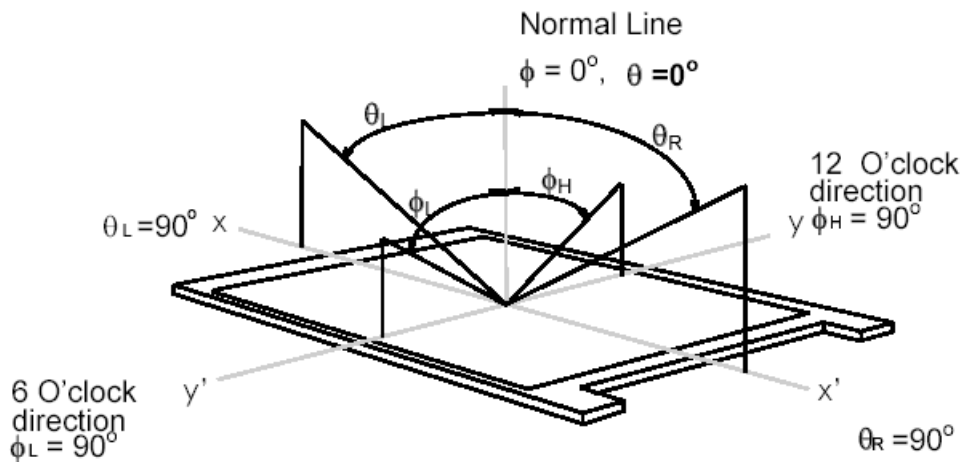

**Note 3: Contrast ratio** is measured by TOPCON SR-3

**Note 4: Definition of Response time** measured by Westar TRD-100A

The output signals of photo detector are measured when the input signals are changed from “Full Black” to “Full White” (rising time,  $T_{rR}$ ), and from “Full White” to “Full Black” (falling time,  $T_{rF}$ ), respectively. The response time is interval between the 10% and 90% (1 frame at 60 Hz) of amplitudes.

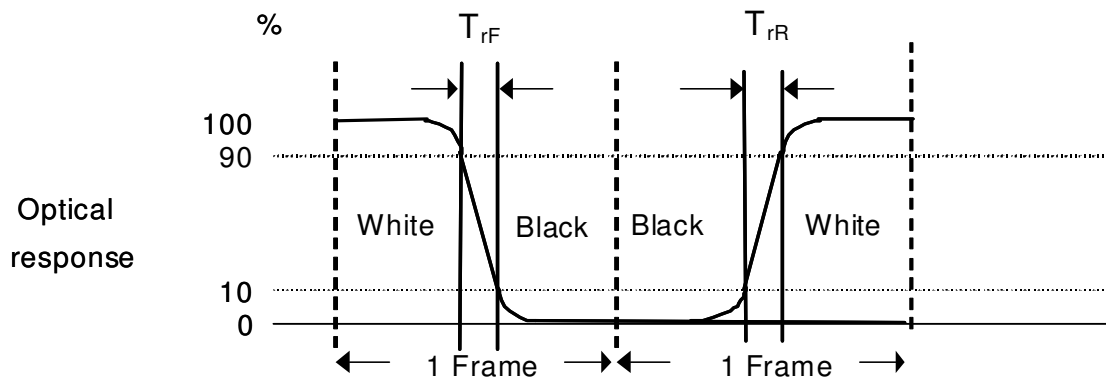

$T_{rR} + T_{rF} = 5$  msec (typ.).

**Note 5: Color chromaticity and coordinates (CIE)** is measured by TOPCON SR-3

**Note 6: Central luminance** is measured by TOPCON SR-3

**Note 7: Luminance uniformity of these 9 points** is defined as below and measured by TOPCON SR-3

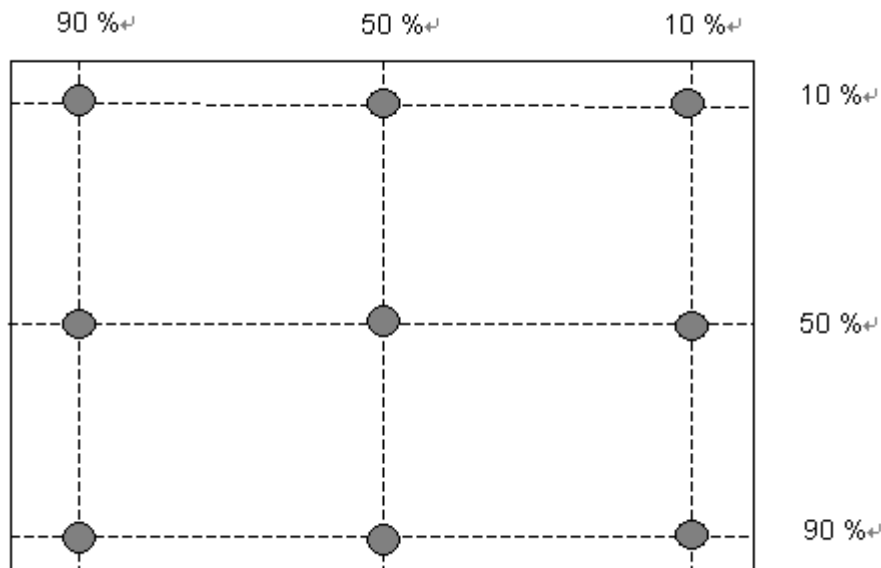

$$\text{Uniformity} = \frac{\text{Minimum Luminance in 9 points (1-9)}}{\text{Maximum Luminance in 9 Points (1-9)}}$$



**Note 8: Crosstalk is defined as below and measured by TOPCON SR-3**

$$CT = | YB - YA | / YA \times 100 (\%)$$

Where

YA = Luminance of measured location without gray level 0 pattern (cd/m<sup>2</sup>)

YB = Luminance of measured location with gray level 0 pattern (cd/m<sup>2</sup>)

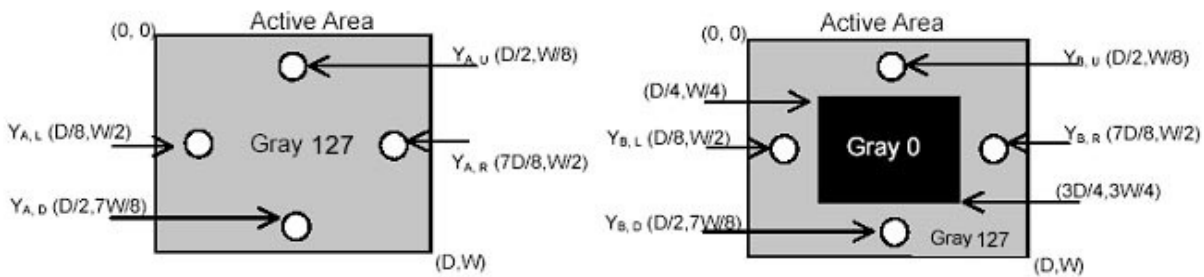

**Note 9: Test Pattern: Subchecker Pattern measured by TOPCON SR-3**

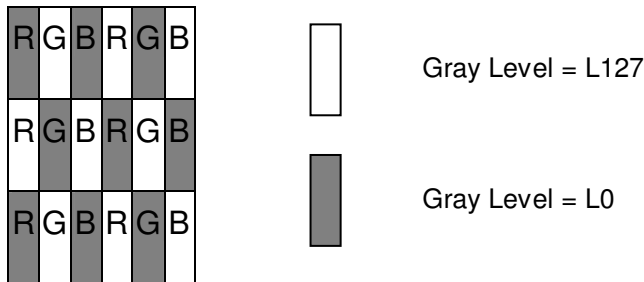

Method: Record dBV & DC value with TRD-100

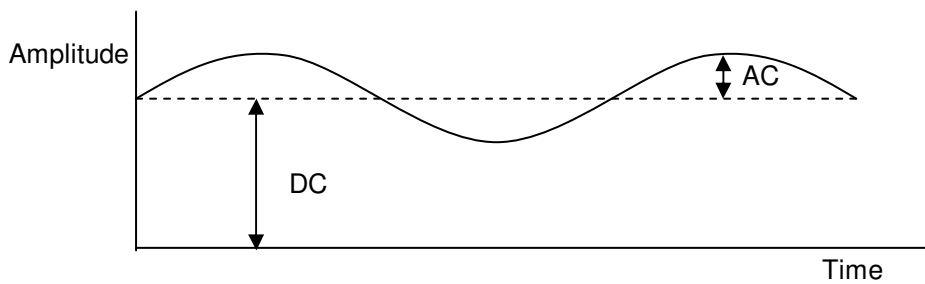

$$\text{Flicker (dB)} = 20 \log \frac{\text{AC Level(at 30 Hz)}}{\text{DC Level}}$$

## 2.3 Mechanical Characteristics

Item	Unit	Min.	Note
Compression Endurance	[Kgf]	2.5	1

Note 1: Test Method

- The point is at a distance from right-downside 25mm x 25mm defined as the Start Point of Measure Points, and the point is at a distance 25mm from left-side & around 10mm from PCB defined as the End Point.
- Align 50mm x 50mm block from Start Point on the Bezel Back, and the corners of each block are Measure Points.
- If the distance from the last block to each side of the End Point  $\geq 25$ mm, add other blocks to make sure that most area of Bezel Back can be measured.

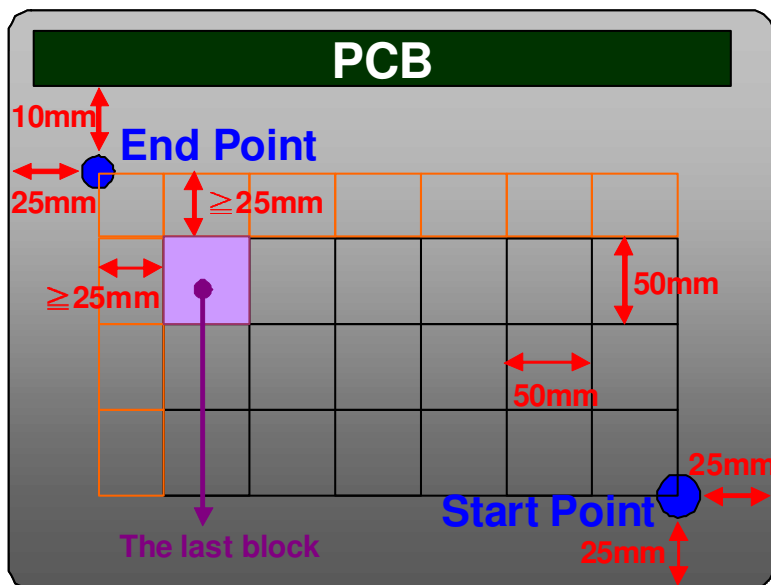

### 3.0 Functional Block Diagram

The following diagram shows the functional block of the 18.5 inch Color TFT-LCD Module:

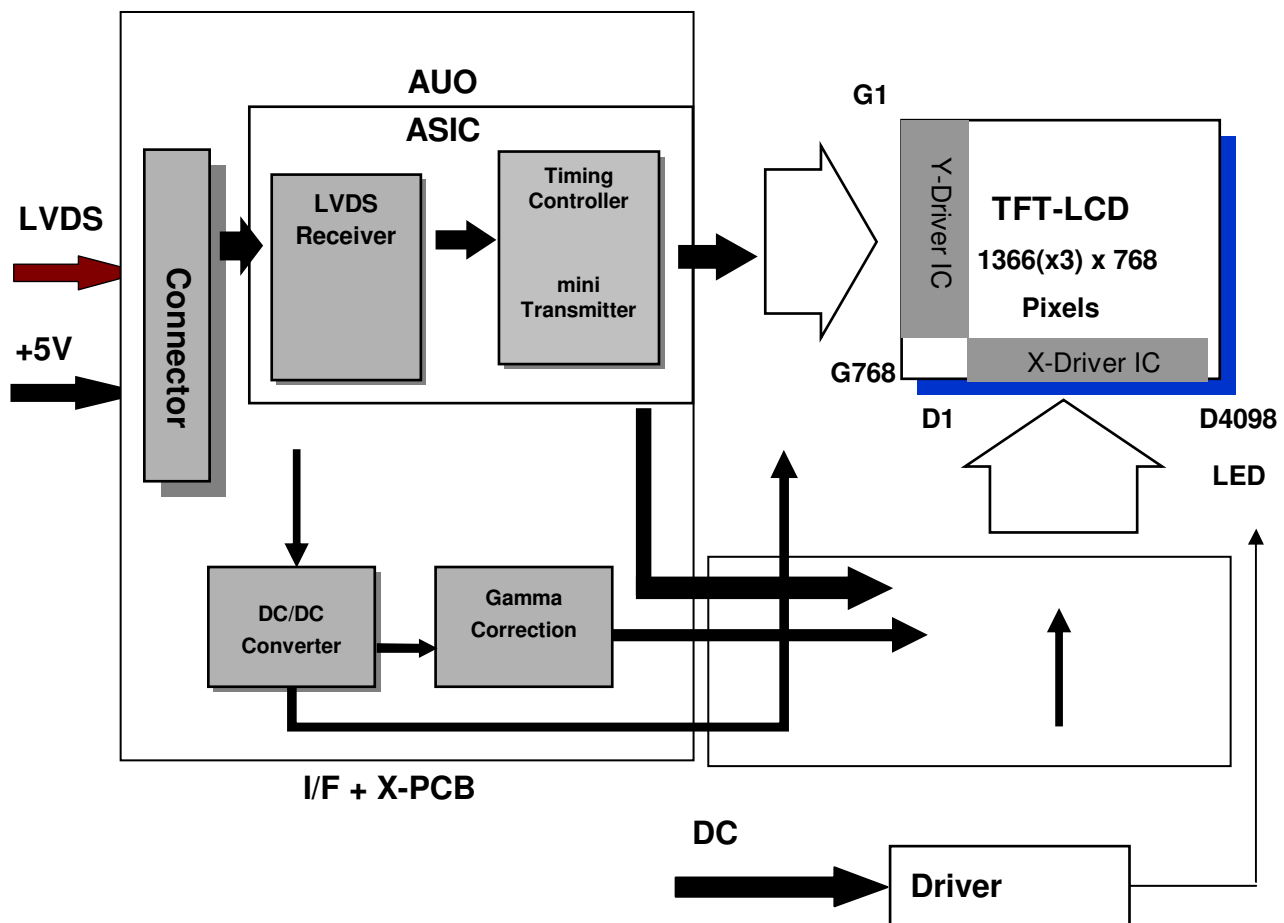

#### I/F PCB Interface:

MSCKT2407P30HB (STM) / AL230F-A0G1D-P (P-TWO)

#### Mating Type:

FI-X30HL(JAE) (Locked Type)

FI-X30H (JAE)(Unlocked Type)

## 4.0 Absolute Maximum Ratings

Absolute maximum ratings of the module are as following:

### 4.1 TFT LCD Module

Item	Symbol	Min	Max	Unit	Conditions
Logic/LCD Drive Voltage	VDD	0	+6.0	[Volt]	<b>Note 1,2</b>

### 4.2 Backlight Unit

Item	Symbol	Min	Max	Unit	Conditions
LED Forward Current	IRLED1	0	90	[mA]	<b>Note 1,2,5</b> 100% duty
	IRLED2				
	IRLED3				
	IRLED4				
LED Pulse Forward Current	IPLD1	-	150	[mA]	<b>Note 1,2,5</b> 10% duty @100Hz
	IPLD2				
	IPLD3				
	IPLD4				
LED forward Voltage variation (per string variation)	$\Delta V_f$	-	3.4	[Volt]	<b>Note 1,2</b>

### 4.3 Absolute Ratings of Environment

Item	Symbol	Min.	Max.	Unit	Conditions
Operating Temperature	TOP	0	+50	[°C]	<b>Note 3</b>
Glass surface temperature (operation)	TGS	0	+65	[°C]	<b>Note 3, Note 4</b>
Operation Humidity	HOP	5	90	[%RH]	<b>Note 3</b>
Storage Temperature	TST	-20	+60	[°C]	
Storage Humidity	HST	5	90	[%RH]	

**Note 1:** With in Ta (25°C)

**Note 2:** Permanent damage to the device may occur if exceeding maximum values

**Note 3:** Temperature and relative humidity range are shown as the below figure.

1. 90% RH Max ( Ta ≤ 39°C )
2. Max wet-bulb temperature at 39°C or less. ( Ta ≤ 39°C )
3. No condensation

**Note 4:** Function Judged only

**Note 5:** IRLED1,2,3,4 and IPLD1,2,3,4 define as per strings LED current.

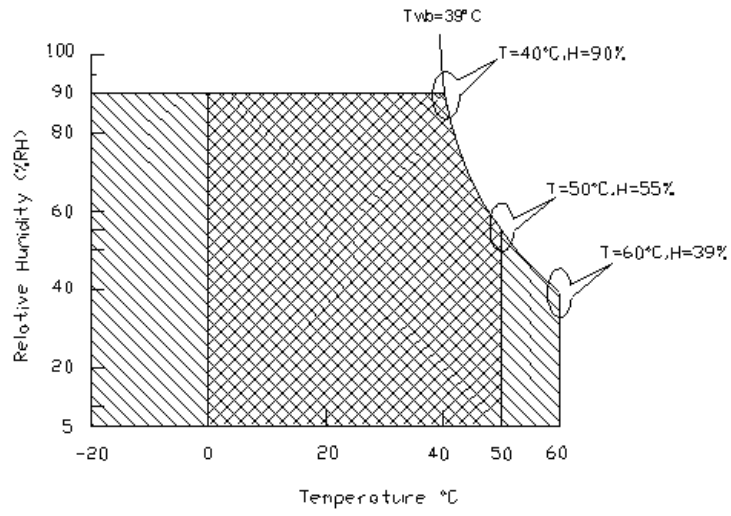

Operating Range



Storage Range

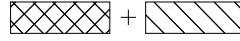

## 5.0 Electrical characteristics

### 5.1 TFT LCD Module

#### 5.1.1 Power Specification

Input power specifications are as following:

Symbol	Parameter	Min	Typ	Max	Unit	Conditions
VDD	Logic/LCD Drive Voltage	4.5	5.0	6	[Volt]	+/-10%
IDD	Input Current	-	0.35	0.42	[A]	VDD= 5.0V, All Black Pattern At 60Hz,
		-	0.42	0.5		VDD= 5.0V, All Black Pattern At 75Hz
PDD	VDD Power	-	1.75	2.1	[Watt]	VDD= 5.0V, All Black Pattern At 60Hz
		-	2.1	2.5		VDD= 5.0V, All Black Pattern At 75Hz
IRush	Inrush Current	-	-	TBD	[A]	Note 1
VDDrp	Allowable Logic/LCD Drive Ripple Voltage	-	-	350	[mV] p-p	VDD= 5.0V, All Black Pattern At 75Hz

**Note 1:** Measurement conditions:

The duration of rising time of power input is 470us.

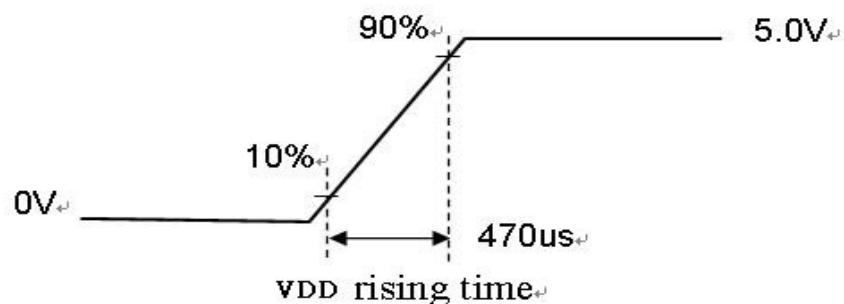
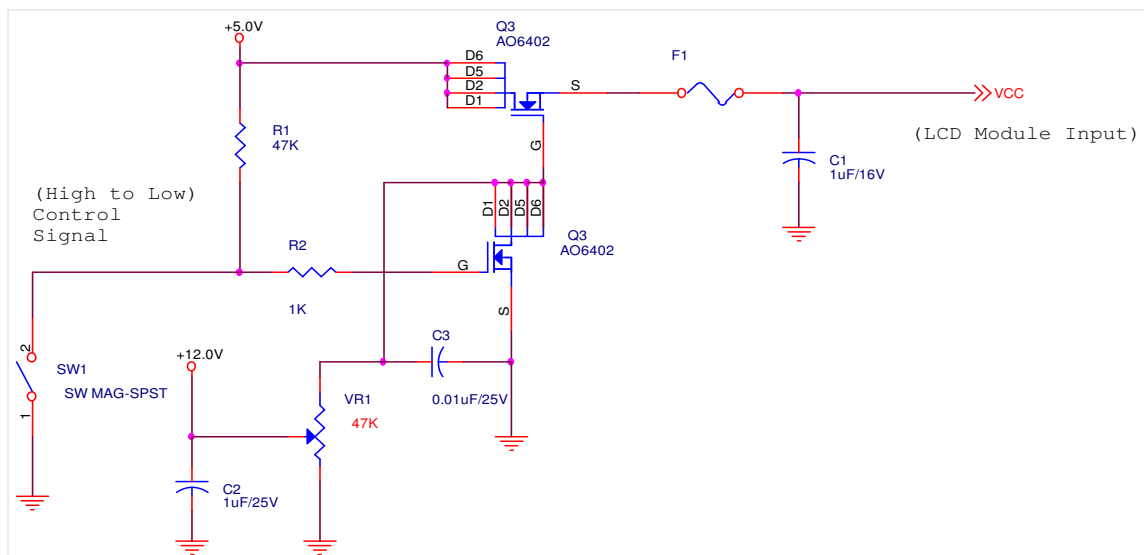

## 5.1.2 Signal Electrical Characteristics

Input signals shall be low or Hi-Z state when VDD is off. Please refer to specifications of SN75LVDS82DGG (Texas Instruments) in detail.

### 1. DC Characteristics of each signal are as following:

Symbol	Parameter	Min	Typ	Max	Units	Condition
V <sub>TH</sub>	Differential Input High Threshold	-	-	+100	[mV]	V <sub>CM</sub> = 1.2V <b>Note 1</b>
V <sub>TL</sub>	Differential Input Low Threshold	-100	-	-	[mV]	V <sub>CM</sub> = 1.2V <b>Note 1</b>
V <sub>ID</sub>	Input Differential Voltage	100	-	600	[mV]	<b>Note 1</b>
V <sub>CM</sub>	Differential Input Common Mode Voltage	+1.0	+1.2	+1.5	[V]	V <sub>TH</sub> -V <sub>TL</sub> = 200mV (max) <b>Note 1</b>

**Note 1:** LVDS Signal Waveform

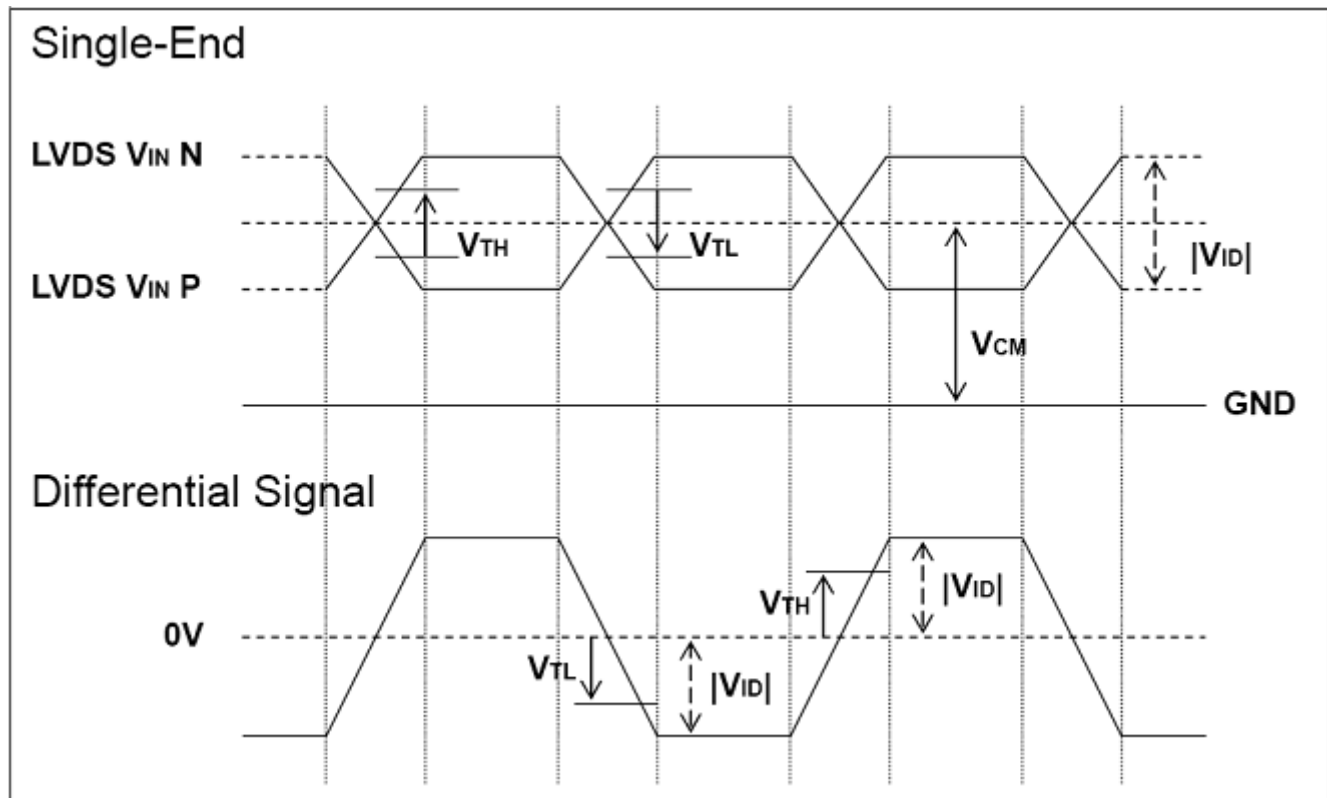

## 2. AC Characteristics

Description	Symbol	Min	Max	Unit	Note
Maximum deviation of input clock frequency during SSC	$F_{DEV}$	-	$\pm 3$	%	
Maximum modulation frequency of input clock during SSC	$F_{MOD}$	-	200	KHz	

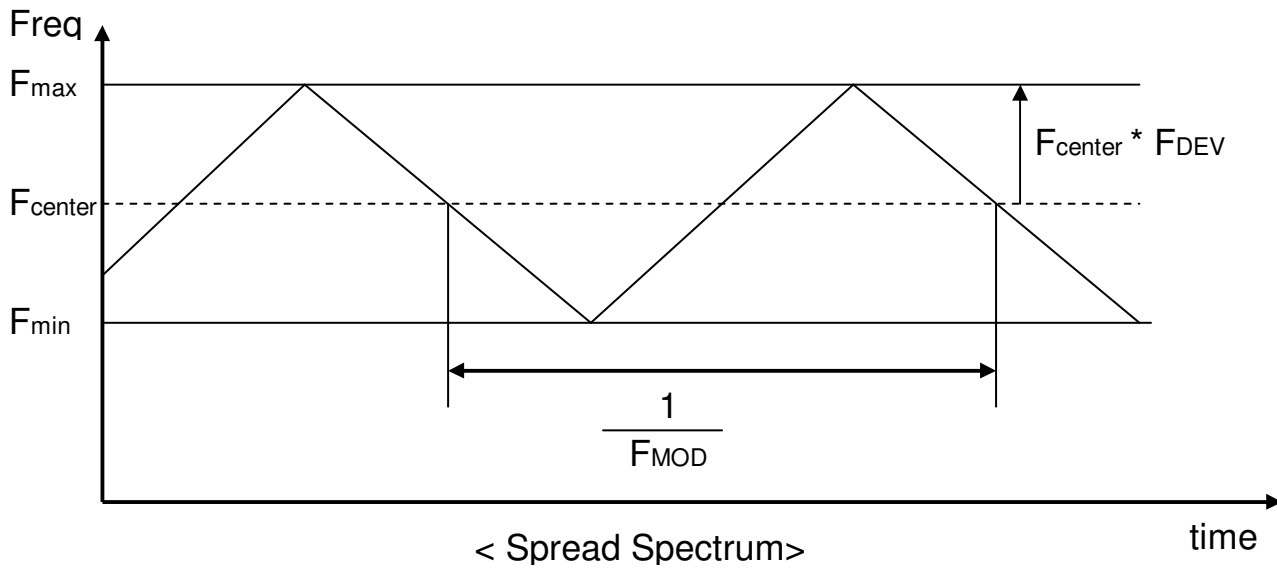



## 5.2 Backlight Unit

Parameter guideline for LED driving is under stable conditions at 25°C (Room Temperature):

Symbol	Description	Min.	Typ.	Max.	Unit	Note
IRLED1	LED Operation Current	67	70	73	[mA]	<b>Note 1</b>
IRLED2						
IRLED3						
IRLED4						
VLED	Light Bar Operation Voltage	24	25.6	27.2	[Volt]	<b>Note 2</b>
PBLU	BLU Power Consumption	6.4	7.2	7.9	[Watt]	<b>Note 3</b>
LTLED	LED Life Time (Typical)	30,000	-	-	[Hour]	<b>Note 4</b>

Each module consists of 32 pcs LED ( 4 strings x 8 pcs / string )

Note 1 : The specified current is 100% duty of LED chip input current, IRLED1,2,3,4 define as per strings LED current.

Note 2 : The value showed in the table is one light bar's operation voltage.

Note 3 :  $PBLU = VLED * ( IRLED1 + IRLED2 + IRLED3 + IRLED4 )$

Note 4: Definition of life time: Brightness becomes to 50% of its original value. The minimum life time of LED unit is on the condition of IRLED = 70mA and 25±2°C (Room Temperature).

## 6.0 Signal Characteristic

### 6.1 Pixel Format Image

Following figure shows the relationship of the input signals and LCD pixel format.

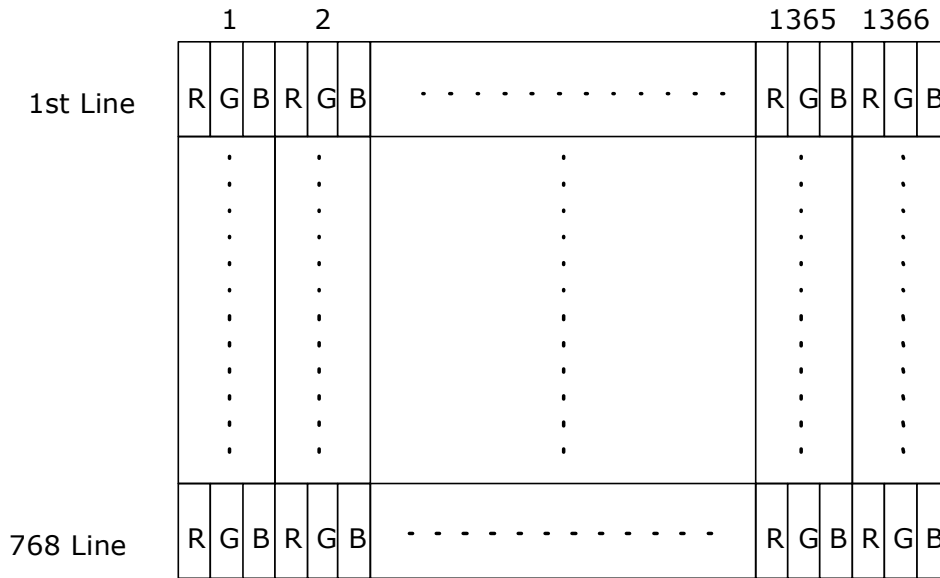

### 6.2 The input data format

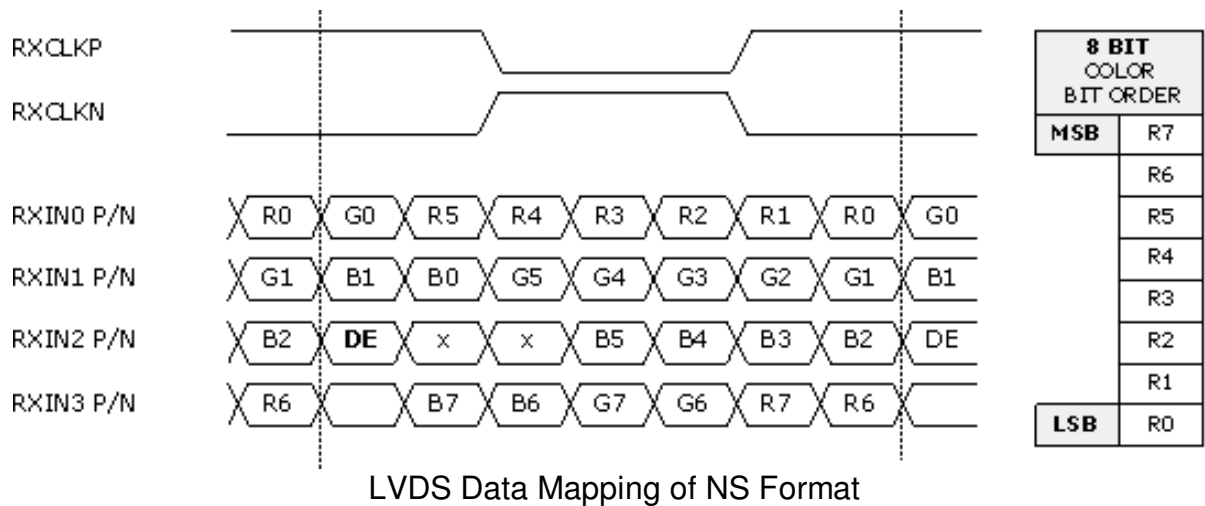

Note1: Normally, DE, VS, HS on EVEN channel are not used.

Note2: 8-bits signal input.

## 6.3 Signal Description

PIN #	SIGNAL NAME	DESCRIPTION
1	NC	No contact (For AUO internal use)
2	NC	No contact (For AUO internal use)
3	NC	No contact (For AUO internal use)
4	GND	Power Ground
5	RXIN0-	Negative LVDS differential data input (0)
6	RXIN0+	Positive LVDS differential data input (0)
7	GND	Power Ground
8	RXIN1-	Negative LVDS differential data input (1)
9	RXIN1+	Positive LVDS differential data input (1)
10	GND	Power Ground
11	RXIN2-	Negative LVDS differential data input (2)
12	RXIN2+	Positive LVDS differential data input (2)
13	GND	Power Ground
14	RXCLKIN-	Negative LVDS differential clock input (clock)
15	RXCLKIN+	Positive LVDS differential data input (clock)
16	GND	Power Ground
17	RXIN3-	Negative LVDS differential data input (3)
18	RXIN3+	Positive LVDS differential data input (3)
19	GND	Power Ground
20	NC	No contact (For AUO internal use)
21	NC	No contact (For AUO internal use)
22	NC	No contact (For AUO internal use)
23	GND	Power Ground
24	GND	Power Ground
25	GND	Power Ground
26	VCC	+5V power supply
27	VCC	+5V power supply
28	VCC	+5V power supply
29	VCC	+5V power supply
30	VCC	+5V power supply

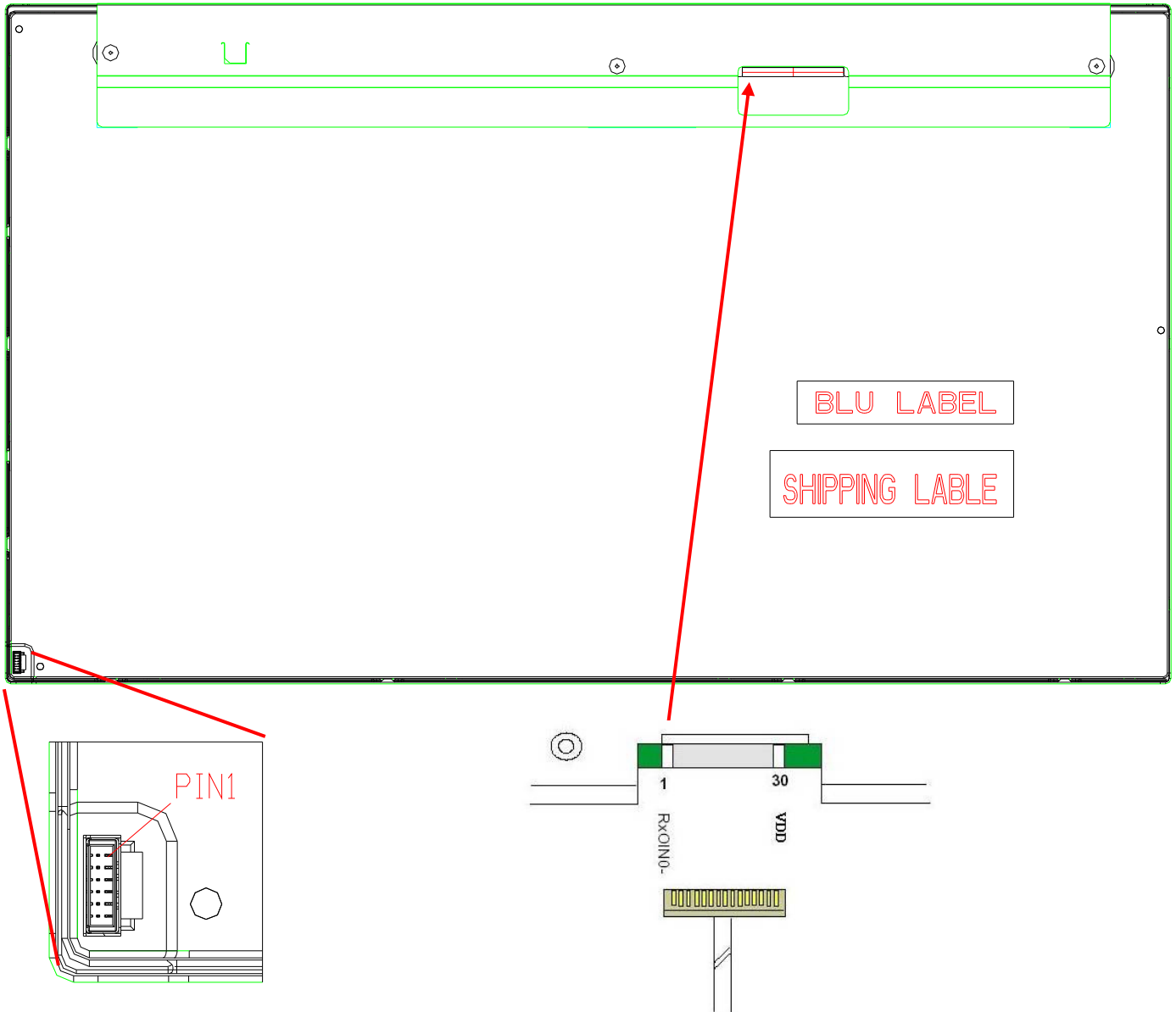

## 6.4 Timing Characteristics

Basically, interface timing described here is not actual input timing of LCD module but close to output timing of SN75LVDS82DGG (Texas Instruments) or equivalent.

Signal	Item	Symbol	Min	Typ	Max	Unit
<b>V-section</b>	Period	T <sub>v</sub>	776	808	1023	Th
	Active	T <sub>disp(v)</sub>	768	768	768	Th
	Blanking	T <sub>blk(v)</sub>	8	40	255	Th
<b>H-section</b>	Period	T <sub>h</sub>	1416	1606	2047	Tclk
	Active	T <sub>disp(h)</sub>	1366	1366	1366	Tclk
	Blanking	T <sub>blk(h)</sub>	50	240	681	Tclk
<b>Clock</b>	Period	Tclk	-	12.8	-	ns
	Frequency	Freq	55	78	94	MHz
<b>Frame Rate</b>	Frame Rate	F	50	60	75	Hz

**Note1** : DE mode only

**Note2** : Clock Frequency 94MHz(Max.)= 1480(H)\*847(V)\*75Hz

## 6.5 Timing diagram

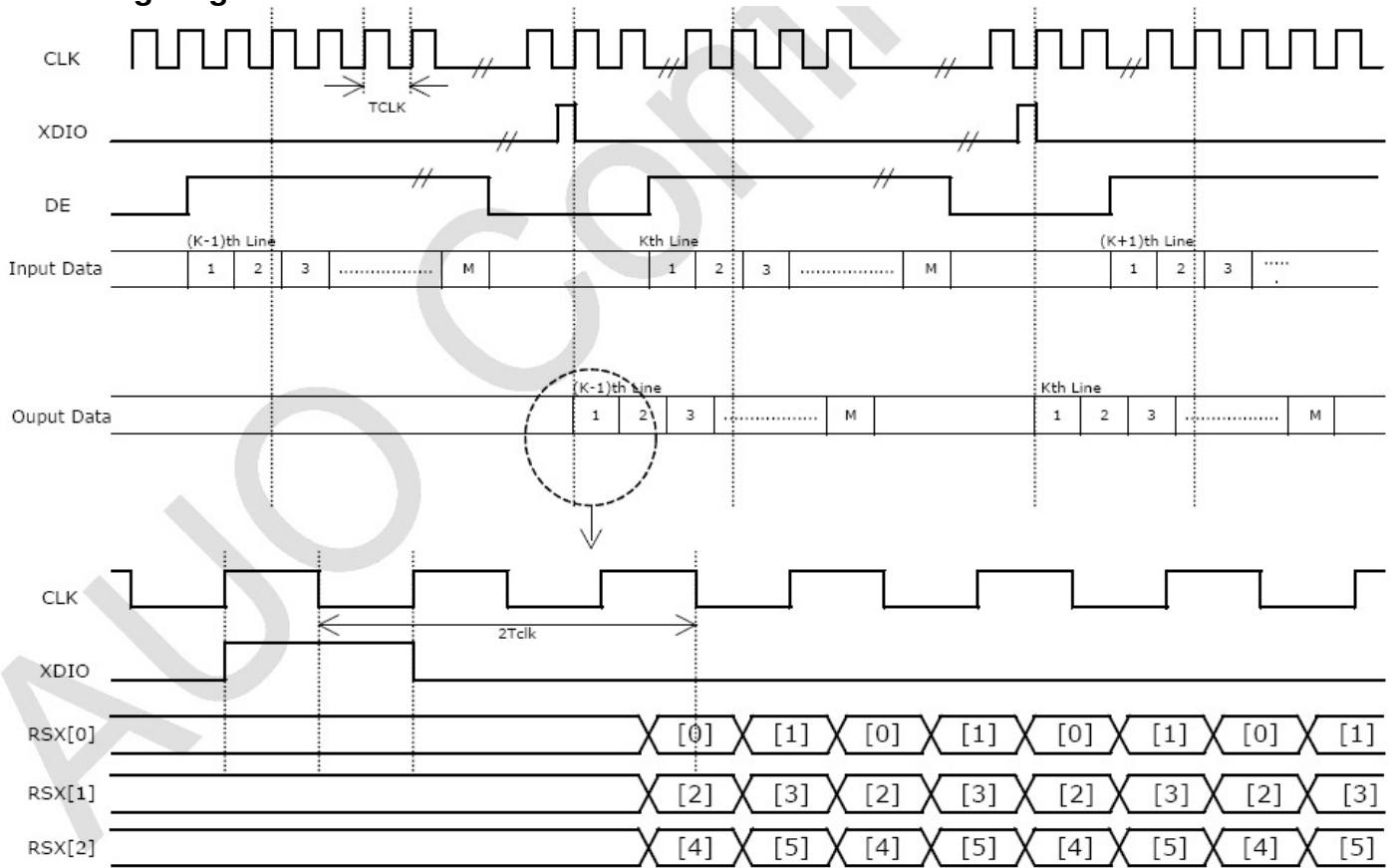

## 6.6 Power ON/OFF Sequence

VDD power and lamp on/off sequence are as follows. Interface signals are also shown in the chart. Signals from any system shall be Hi-Z state or low level when VDD is off.

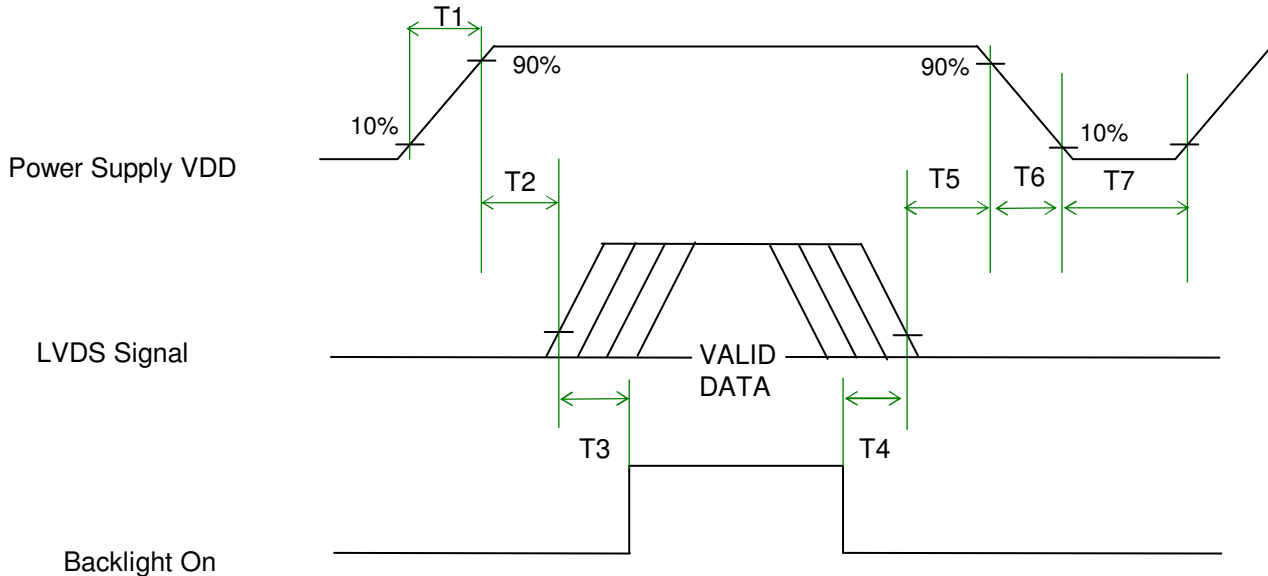

**Power Sequence Timing**

Parameter	Value			Unit
	Min.	Typ.	Max.	
T1	0.5	-	10	[ms]
T2	0	-	50	[ms]
T3	500	-	-	[ms]
T4	100	-	-	[ms]
T5	0	-	50	[ms] Note1,2
T6	5	-	100	[ms] Note1,2
T7	1000	-	-	[ms]

**Note1 :** Recommend setting T5 = 0ms to avoid electronic noise when VDD is off.

**Note2 :** During T5 and T6 period , please keep the level of input LVDS signals with Hi-Z state.

## 7.0 Connector & Pin Assignment

Physical interface is described as for the connector on module. These connectors are capable of accommodating the following signals and will be following components.

### 7.1 TFT LCD Module

Connector Name / Designation	Interface Connector / Interface card
Manufacturer	STM or P-TWO
Type Part Number	MSCKT2407P30HB (STM) / AL230F-A0G1D-P (P-TWO)
Mating Housing Part Number	FI-X30HL(JAE) (Locked Type) FI-X30H (JAE)(Unlocked Type)

#### 7.1.1 Pin Assignment

Pin#	Signal Name	Pin#	Signal Name
1	NC	2	NC
3	NC	4	GND
5	RXIN0-	6	RXIN0+
7	GND	8	RXIN1-
9	RXIN1+	10	GND
11	RXIN2-	12	RXIN2+
13	GND	14	RXCLKIN-
15	RXCLKIN+	16	GND
17	RXIN3-	18	RXIN3+
19	GND	20	NC
21	NC	22	NC
23	GND	24	GND
25	GND	26	VCC
27	VCC	28	VCC
29	VCC	30	VCC



## 7.2 LED Connector on Backlight Unit.

This connector is mounted on LED light-bar.

Connector Name / Designation	Light Bar Connector
Manufacturer	ENTERY (E&T) Corporation
Mating Type Part Number	<b>3707K-Q06N-01R</b> (Wire harness)

### 7.2.1 LED Pin assignment

Pin#	Signal Name
1	IRLED1 (current out)
2	IRLED2 (current out)
3	VLED (voltage in)
4	VLED (voltage in)
5	IRLED3 (current out)
6	IRLED4 (current out)

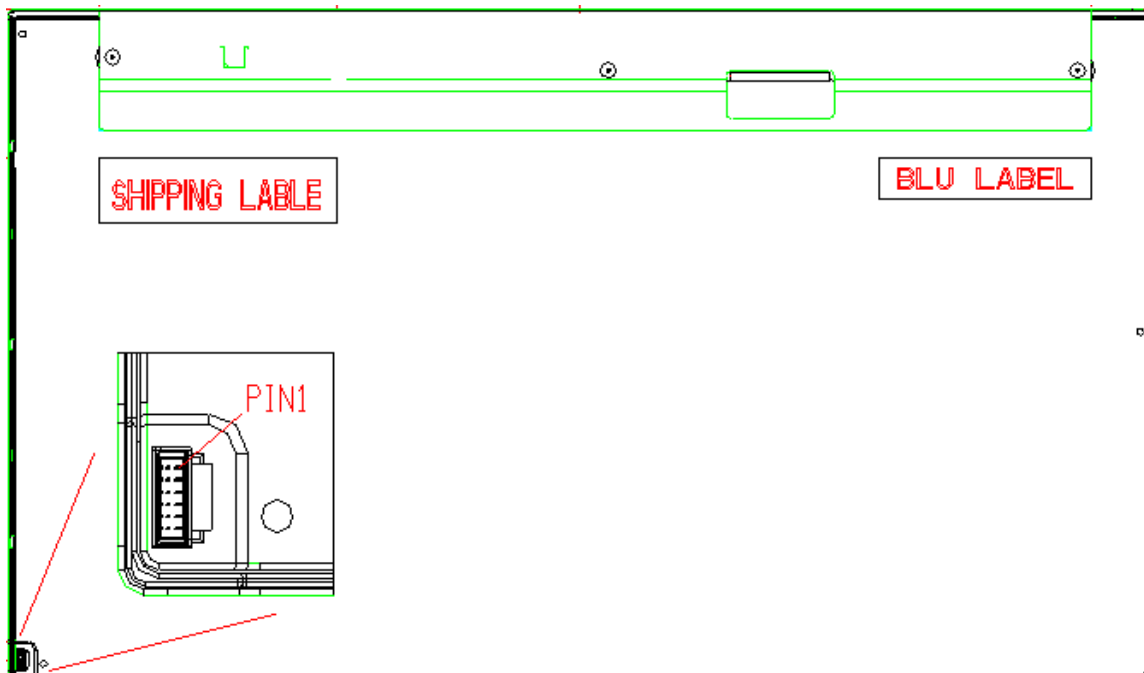

## 7.2.2 LED Connector dimension

$H \times V \times D = 13.9 \times 3.00 \times 4.25$ , Pitch = 1.0 (unit = mm)

$H \times V \times D = 13.9 \times 3.00 \times 4.25$ , Pitch = 1.0 (unit = mm)

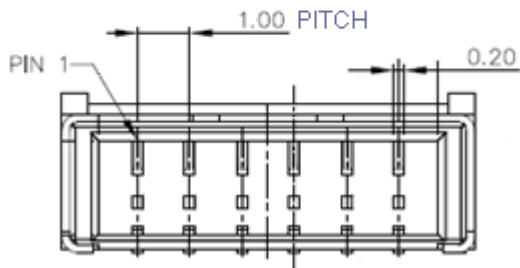
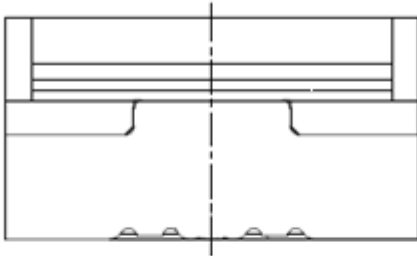

## 7.2.3 LED Mating housing dimension

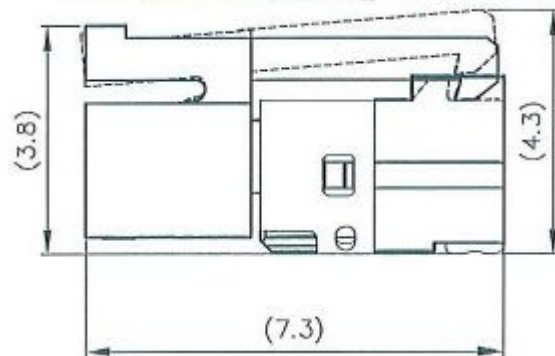
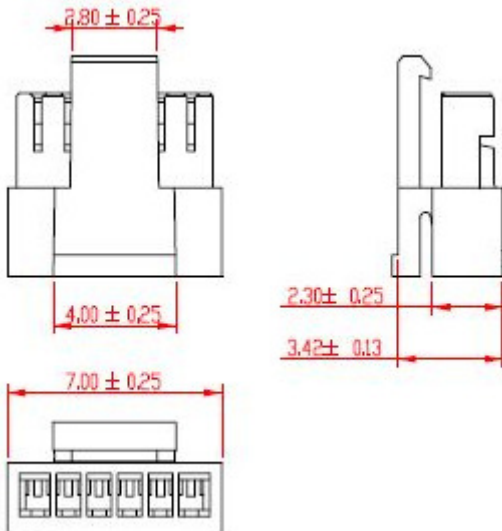

## 8.0 Reliability Test

Environment test conditions are listed as following table.

Items	Required Condition	Note
Temperature Humidity Bias (THB)	Ta= 50°C , 80%RH, 300hours	
High Temperature Operation (HTO)	Ta= 50°C , 50%RH, 300hours	
Low Temperature Operation (LTO)	Ta= 0°C , 300hours	
High Temperature Storage (HTS)	Ta= 60°C , 300hours	
Low Temperature Storage (LTS)	Ta= -20°C , 300hours	
Vibration Test (Non-operation)	Acceleration: 1.5 Grms Wave: Random Frequency: 10 - 200 Hz Duration: 30 Minutes each Axis (X, Y, Z)	
Shock Test (Non-operation)	Acceleration: 50 G Wave: Half-sine Active Time: 20 ms Direction: ±X, ±Y, ±Z (one time for each Axis)	
Drop Test	Height: 46 cm, package test	
Thermal Shock Test (TST)	-20°C/30min, 60°C/30min, 100 cycles	<b>1</b>
On/Off Test	On/10sec, Off/10sec, 30,000 cycles	
ESD (Electro Static Discharge)	Contact Discharge: ± 15KV, 150pF(330Ω ) 1sec, 15 points, 25 times/ point.	<b>2</b>
	Air Discharge: ± 15KV, 150pF(330Ω ) 1sec 15 points, 25 times/ point.	
Altitude Test	Operation:18,000 ft Non-Operation:40,000 ft	

**Note 1:** The TFT-LCD module will not sustain damage after being subjected to 100 cycles of rapid temperature change. A cycle of rapid temperature change consists of varying the temperature from -20°C to 60°C, and back again. Power is not applied during the test. After temperature cycling, the unit is placed in normal room ambient for at least 4 hours before power on.

**Note 2:** EN61000-4-2, ESD class B:

- Certain performance degradation allowed
- No data lost
- Self-recoverable
- No hardware failures.

## 9.0 Shipping Label

The label is on the panel as shown below:

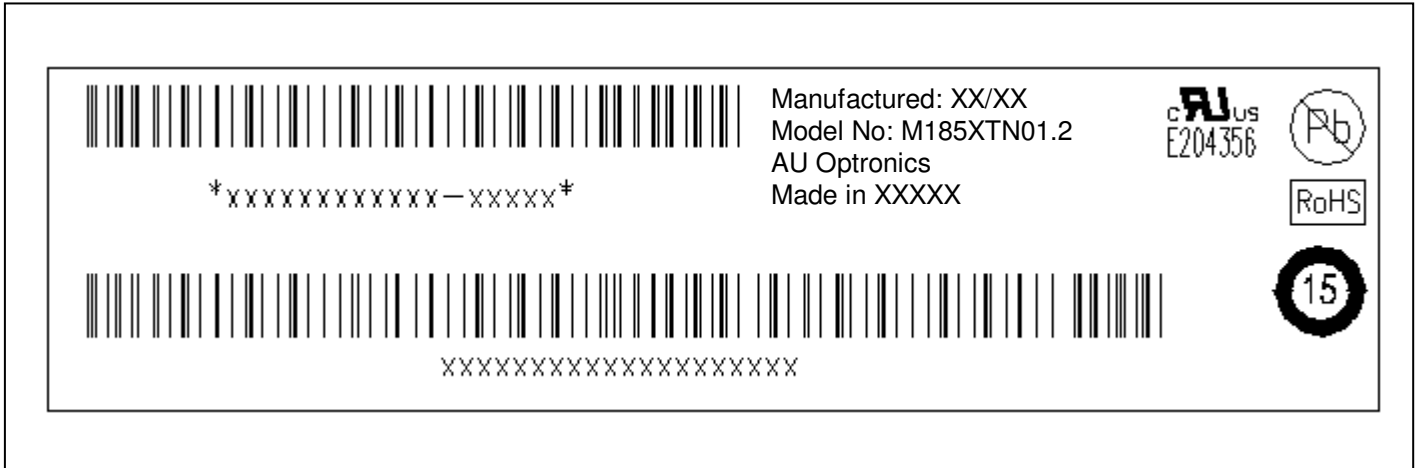

**Note 1:** For Pb Free products, AUO will add  for identification.

**Note 2:** For RoHS compatible products, AUO will add  for identification.

**Note 3:** For China RoHS compatible products, AUO will add  for identification.

**Note 4:** The Green Mark will be presented only when the green documents have been ready by AUO Internal Green Team.

### 10.0 Mechanical Characteristics

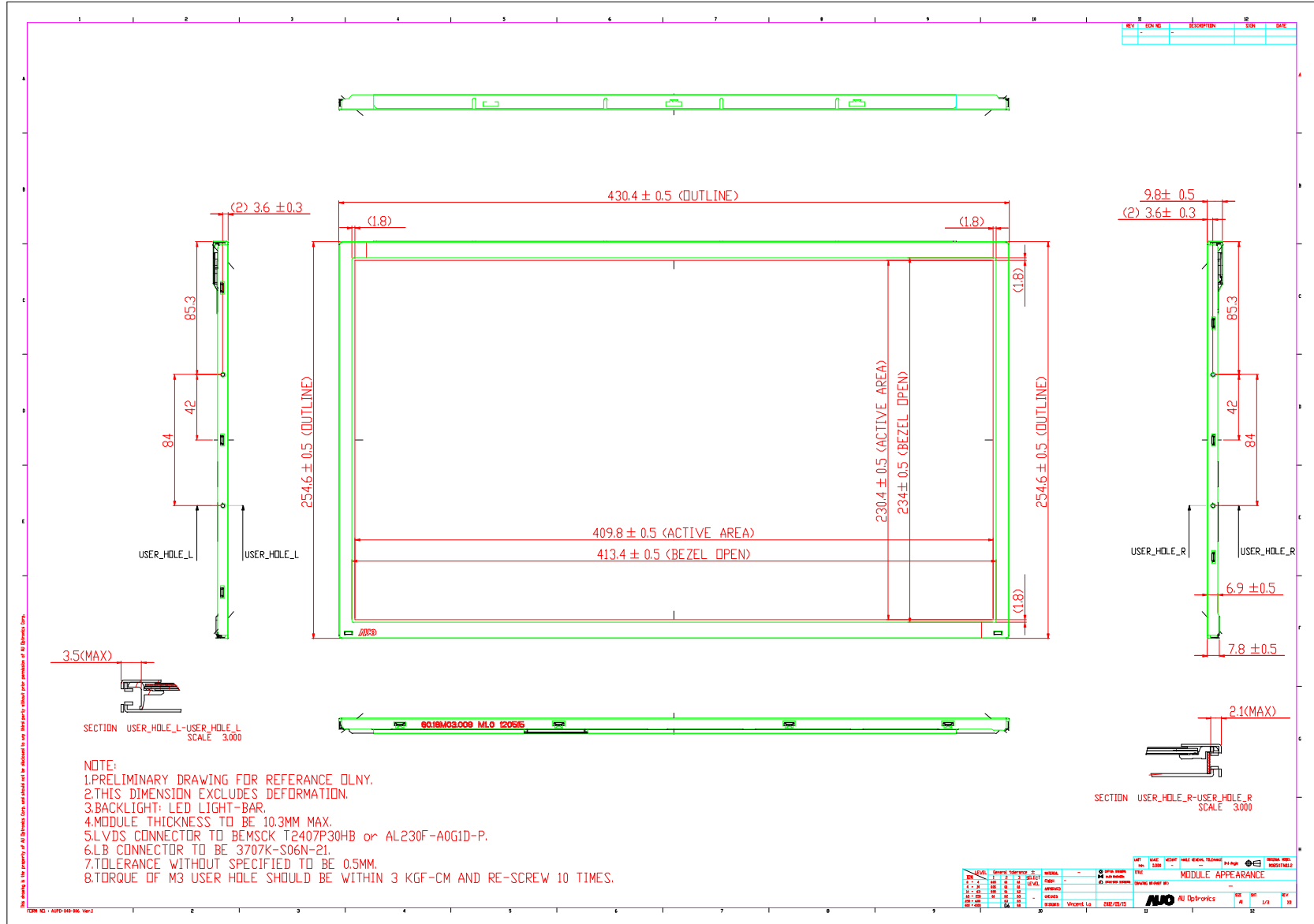



# Product Specification

M185XTN01.2

AU OPTRONICS CORPORATION

**NOTES :**

1. THE DIMENSION EXCLUDES DEFORMATION.
2. TOLERANCE WITHOUT NOTICED TO BE ±0.5MM.

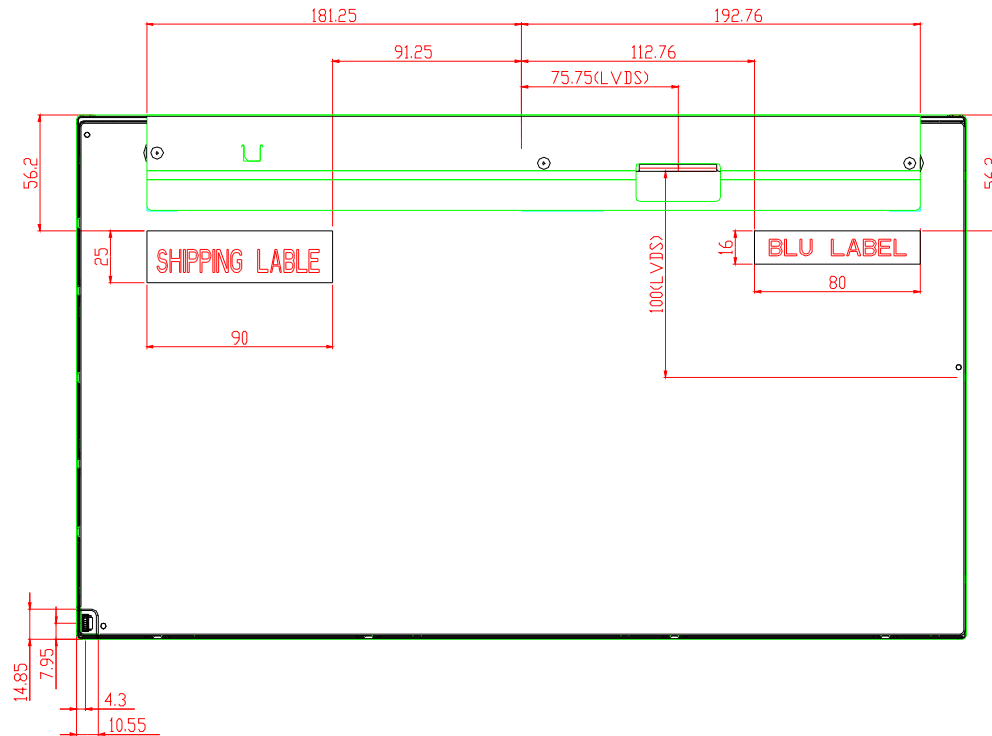

REV	REV NO	DESCRIPTION	BY	DATE
-	-	-	-	-

This drawing is the property of AU Optronics Corp and shall not be released to any third party without prior permission of AU Optronics Corp.

FORM NO. : AOPS-06-06\_V01.1

REV	REV NO	DESCRIPTION	BY	DATE
-	-	-	-	-

ITEM NO	LEVEL	DESCRIPTION	QTY	UNIT	REVISION
1	1	MODULE APPEARANCE	1	PCB	1
2	1	MODULE APPEARANCE	1	PCB	1
3	1	MODULE APPEARANCE	1	PCB	1
4	1	MODULE APPEARANCE	1	PCB	1
5	1	MODULE APPEARANCE	1	PCB	1
6	1	MODULE APPEARANCE	1	PCB	1
7	1	MODULE APPEARANCE	1	PCB	1
8	1	MODULE APPEARANCE	1	PCB	1
9	1	MODULE APPEARANCE	1	PCB	1
10	1	MODULE APPEARANCE	1	PCB	1
11	1	MODULE APPEARANCE	1	PCB	1
12	1	MODULE APPEARANCE	1	PCB	1
13	1	MODULE APPEARANCE	1	PCB	1
14	1	MODULE APPEARANCE	1	PCB	1
15	1	MODULE APPEARANCE	1	PCB	1
16	1	MODULE APPEARANCE	1	PCB	1
17	1	MODULE APPEARANCE	1	PCB	1
18	1	MODULE APPEARANCE	1	PCB	1
19	1	MODULE APPEARANCE	1	PCB	1
20	1	MODULE APPEARANCE	1	PCB	1
21	1	MODULE APPEARANCE	1	PCB	1
22	1	MODULE APPEARANCE	1	PCB	1
23	1	MODULE APPEARANCE	1	PCB	1
24	1	MODULE APPEARANCE	1	PCB	1
25	1	MODULE APPEARANCE	1	PCB	1
26	1	MODULE APPEARANCE	1	PCB	1
27	1	MODULE APPEARANCE	1	PCB	1
28	1	MODULE APPEARANCE	1	PCB	1
29	1	MODULE APPEARANCE	1	PCB	1
30	1	MODULE APPEARANCE	1	PCB	1

REV	REV NO	DESCRIPTION	BY	DATE
-	-	-	-	-

REV	REV NO	DESCRIPTION	BY	DATE
-	-	-	-	-

## 11. Packing Specification

**M185 14片裝:48.5\*37.2\*34.8cm**

料號:

Carton:81.18M02.008 /Cushion:84.18M02.037



將M185模組置入靜電袋中並折疊後  
依序放入包裝隔板中



放置14片，放入上蓋緩衝，封箱完成

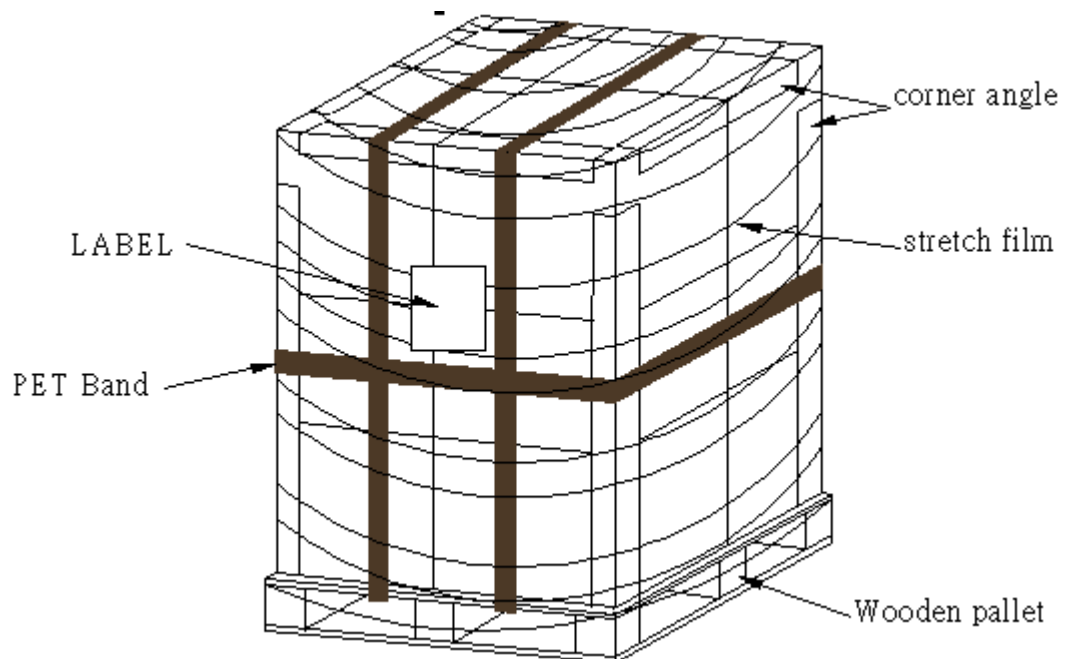
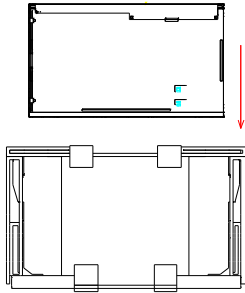

單層 pallet 打棧示意圖



## Pallet and shipment information

	Item	Specification			Remark
		Q'ty	Dimension	Weight(kg)	
1	Panel	1	430.37(H)mm x 254.6(V)mm x 9.9(D)mm	1.330	
2	Cushion	1	-	1.125	
3	Box	1	485(L)mm x 372(W)mm x 348(H)mm	1.00	without Panel & cushion
4	Packing Box	14 pcs/Box	485(L)mm x 372(W)mm x 348(H)mm	20.745	with panel & cushion
5	Pallet	1	1150(L)mm x 980(W)mm x 138(H)mm	15	
6	Pallet after Packing	24 boxes/pallet	1150(L)mm x 980(W)mm x 138(H)mm	509	