

# **Specification for AUO M190EN03 V1**

**Version February 2005**



## **Product Specification**

**19.0" SXGA Color TFT-LCD Module**

**Model Name: M190EN03**

**V.1**

**(◆) Preliminary Specifications**

**( ) Final Specifications**

**Note: This Specification is subject to change without notice.**



## Contents

<b>1.0 Handling Precautions.....</b>	<b>6</b>
<b>2.0 General Description .....</b>	<b>7</b>
2.1 Display Characteristics.....	7
2.2 Optical Characteristics.....	8
<b>3.0 Functional Block Diagram .....</b>	<b>11</b>
<b>4.0 Absolute Maximum Ratings.....</b>	<b>12</b>
4.1 TFT LCD Module .....	12
4.2 Backlight Unit.....	12
4.3 Absolute Ratings of Environment.....	12
<b>5.0 Electrical characteristics .....</b>	<b>13</b>
5.1 TFT LCD Module .....	13
5.1.1 Power Specification .....	13
5.1.2 Signal Electrical Characteristics.....	14
5.2 Backlight Unit.....	15
<b>6.0 Signal Characteristic.....</b>	<b>16</b>
6.1 Pixel Format Image .....	16
6.2 The Input Data Format.....	16
6.3 Signal Description.....	17
6.4.1 Timing Characteristics.....	19
6.4.2 Timing diagram.....	19
6.5 Power ON/OFF Sequence .....	20
<b>7.0 Connector &amp; Pin Assignment.....</b>	<b>21</b>
7.1 TFT LCD Module .....	21
7.2 Backlight Unit.....	22
7.3 Signal for Lamp Connector.....	22
<b>8.0 Vibration, Shock, and Drop .....</b>	<b>22</b>
8.1 Vibration & Shock.....	22
8.2 Drop Test .....	22
<b>9.0 Environment .....</b>	<b>23</b>
9.1 Temperature and Humidity.....	23
9.1.1 Operating Conditions.....	23
9.1.2 Shipping Conditions.....	23
9.2 Atmospheric Pressure.....	23
9.3 Thermal Shock.....	23
<b>10.0 Reliability .....</b>	<b>24</b>
10.1 Failure Criteria.....	24
10.2 Failure Rate.....	24



10.2.1 Usage.....	24
10.2.1 Component De-rating .....	24
10.3 On/OFF Cycle .....	24
<b>11.0 Safety .....</b>	<b>25</b>
11.1 Sharp Edge Requirements.....	25
11.2 Materials .....	25
11.2.1 Toxicity .....	25
11.2.2 Flammability.....	25
11.3 Capacitors.....	25
<b>12.0 Other requirement .....</b>	<b>25</b>
12.1 National Test Lab Requirement.....	25
12.2 Label.....	25
<b>13.0 Mechanical Characteristics.....</b>	<b>26</b>



## Record of Revision

Version and Date	Page	Old description	New Description	Remark
0.1 2004/05/18	All	First Edition for Customer	All	
0.2 2004/07/08	7	2.1 Display Characteristics Contrast Ratio=700:1 (Typ)	2.1 Display Characteristics Contrast Ratio=800:1 (Typ)	Modified
	8	2.2 Optical Chaaracteristics Contrast Ratio (Normal Direction) Min=400 Typ=700	2.2 Optical Chaaracteristics Contrast Ratio Normal Direction Min=500 Typ=800	Modified
	12	4.1 TFT LCD Module Logic/LCD Drive Voltage Min=+4.5	4.1 TFT LCD Module Logic/LCD Drive Voltage Min=-0.3	Modified
	14	5.1.2 Signal Electrical Characteristics VTH/VTL= $\pm 100$ MV	5.1.2 Signal Electrical Characteristics VTH/VTL = $\pm 100$ mV	Modified
	15	5.2 Backlight Unit CCFL Power Consumption Max=24	5.2 Backlight Unit CCFL Power Consumption Max=23.1	Modified



## 1.0 Handling Precautions

- 1) Since front polarizer is easily damaged, pay attention not to scratch it.
- 2) Be sure to turn off power supply when inserting or disconnecting from input connector.
- 3) Wipe off water drop immediately. Long contact with water may cause discoloration or spots.
- 4) When the panel surface is soiled, wipe it with absorbent cotton or other soft cloth.
- 5) Since the panel is made of glass, it may break or crack if dropped or bumped on hard surface.
- 6) Since CMOS LSI is used in this module, take care of static electricity and insure human earth when handling.
- 7) Do not open nor modify the Module Assembly.
- 8) Do not press the reflector sheet at the back of the module to any directions.
- 9) In case if a module has to be put back into the packing container slot after once it was taken out from the container, do not press the center of the CCFL reflector edge. Instead, press at the far ends of the CCFL reflector edge softly. Otherwise the TFT module may be damaged.
- 10) At the insertion or removal of the Signal Interface Connector, be sure not to rotate nor tilt the Interface Connector of the TFT module.
- 11) After installation of the TFT module into an enclosure (Desktop monitor Bezel, for example), do not twist nor bend the TFT Module even momentary. At designing the enclosure, it should be taken into consideration that no bending/twisting forces are applied to the TFT module from outside. Otherwise the TFT module may be damaged.



## 2.0 General Description

This specification applies to the 19.0 inch Color TFT-LCD Module M190EN03.

The display supports the SXGA (1280(H) x 1024(V)) screen format and 16.7M colors (RGB 8-bits data).

All input signals are 2 Channel LVDS interface compatible.

This module does not contain an inverter card for backlight.

## 2.1 Display Characteristics

The following items are characteristics summary on the table under 25 °C condition:

ITEMS	Unit	SPECIFICATIONS
Screen Diagonal	[mm]	480(19")
Active Area	[mm]	376.32 (H) x 301.056 (V)
Pixels H x V		1280(x3) x 1024
Pixel Pitch	[mm]	0.294 (per one triad) x 0.294
Pixel Arrangement		R.G.B. Vertical Stripe
Display Mode		Normally Black
White Luminance ( Center )	[cd/m <sup>2</sup> ]	250 cd/m <sup>2</sup> @7mA (Typ)
Contrast Ratio		800 : 1 (Typ)
Optical Response Time	[msec]	20ms (Typ, on/off)
Nominal Input Voltage VDD	[Volt]	+5.0 V
Power Consumption (VDD line + CCFL line)	[Watt]	30W(Typ) (w/o Inverter, All white pattern)
Weight	[Grams]	2500 (Max)
Physical Size	[mm]	396(W) x 324(H) x 17.5(D) (Typ)
Electrical Interface		Even/Odd R/G/B data, 3 sync signal, Clock
Support Color		16.7M colors (RGB 8-bit data )
Temperature Range		
Operating	[°C]	0 to +50
Storage (Shipping)	[°C]	-20 to +60

## 2.2 Optical Characteristics

The optical characteristics are measured under stable conditions at 25 °C :

Item	Unit	Conditions	Min.	Typ.	Max.	Note
Viewing Angle	[degree]	Horizontal (Right)	75	85	-	
	[degree]	CR = 10 (Left)	75	85	-	
	[degree]	Vertical (Up)	75	85	-	
	[degree]	CR = 10 (Down)	75	85	-	
Contrast Ratio		Normal Direction	500	800		
Response Time	[msec]	Rising Time	-	15	25	<b>Note 1</b>
	[msec]	Falling Time	-	5	15	<b>Note 1</b>
	[msec]	Rising + Falling	-	20	40	<b>Note 1</b>
Color / Chromaticity Coordinates (CIE)		Red x	0.611	0.641	0.671	
		Red y	0.323	0.353	0.383	
		Green x	0.259	0.289	0.319	
		Green y	0.596	0.626	0.656	
		Blue x	0.112	0.142	0.172	
		Blue y	0.048	0.078	0.108	
Color Coordinates (CIE) White		White x	0.283	0.313	0.343	
		White y	0.299	0.329	0.359	
White Luminance at CCFL 7.0mA (central point)	[cd/m <sup>2</sup> ]		200	250	-	
Luminance Uniformity	[%]		70	75	-	<b>Note 2</b>
Crosstalk (in75Hz)	[%]				1.5	<b>Note 3</b>
Flicker	DB				-20	<b>Note 4</b>

Equipment Pattern Generator, Power Supply, Digital Voltmeter, Luminance meter (PR 880, BM-5A , BM 7 ,CS-1000, & EZContrast\* )

Aperture 1 ° with 100cm VD or 2 ° with 50cm viewing distance

Test Point Center (VESA point 9)

Environment < 1 lux

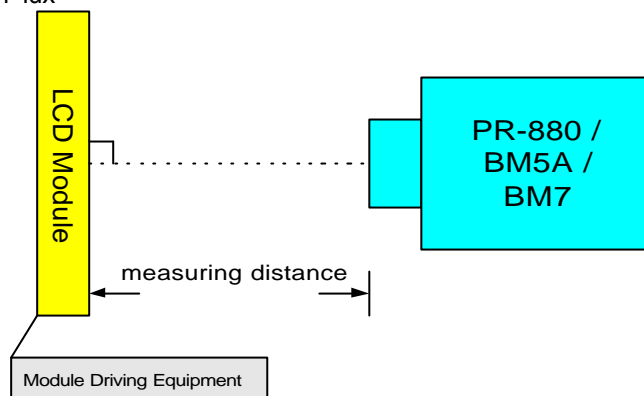

\*' EZ Contrast is different measurement tool with very close viewing distance.





**Note 1: Definition of Response time**

The output signals of photodetector are measured when the input signals are changed from 'Black' to 'White' (rising time), and from 'White' to 'Black' (falling time), respectively. The response time is interval between the 10% and 90% of amplitudes.

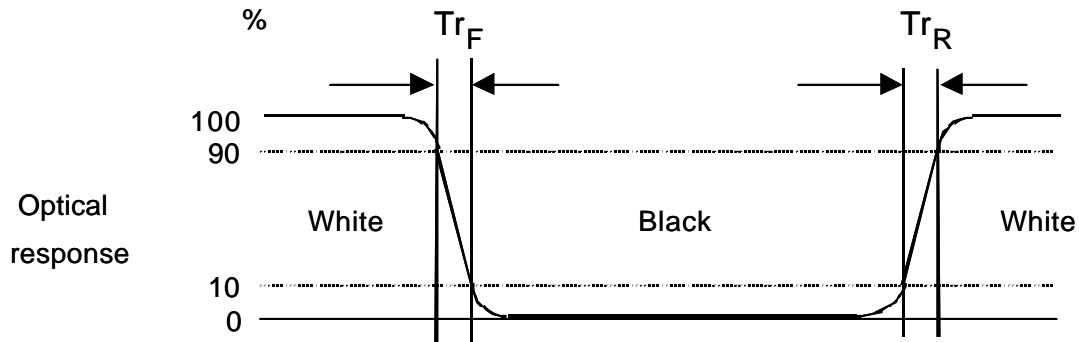

**Note 2: Brightness uniformity of these 9 points is defined as below**

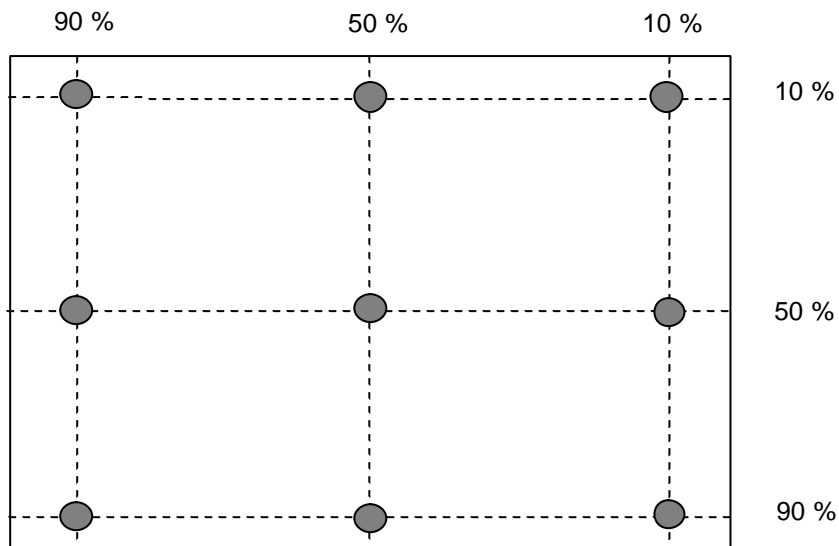

$$\text{Uniformity} = \frac{\text{Minimum Luminance in 9 points (1-9)}}{\text{Maximum Luminance in 9 Points (1-9)}}$$



**Note 3:** Crosstalk is defined as below :

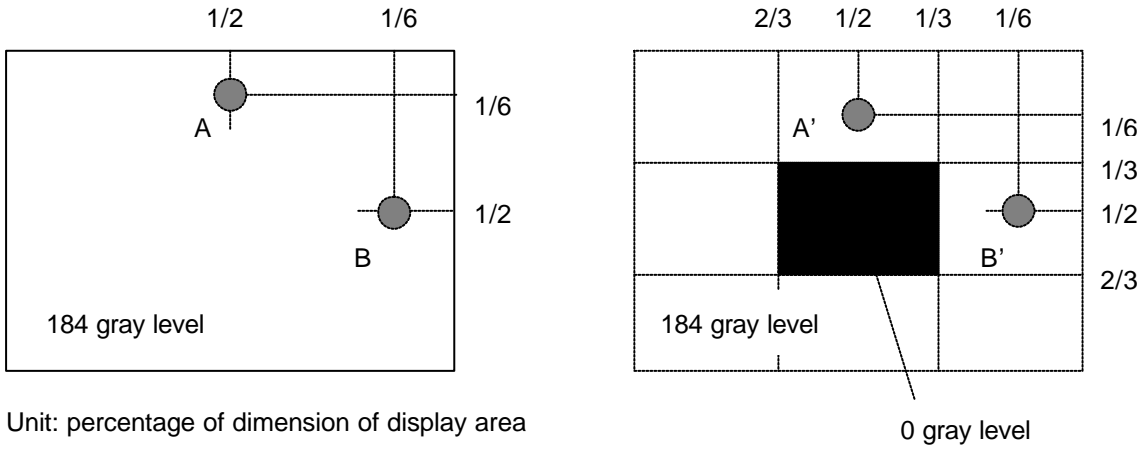

Unit: percentage of dimension of display area

$|L_A - L_{A'}| / L_A \times 100\% = 1.5\% \text{ max.}$ ,  $L_A$  and  $L_B$  are brightness at location A and B

$|L_B - L_{B'}| / L_B \times 100\% = 1.5\% \text{ max.}$ ,  $L_{A'}$  and  $L_{B'}$  are brightness at location A' and B'

**Note 4:** Test Pattern: Subchecker Pattern

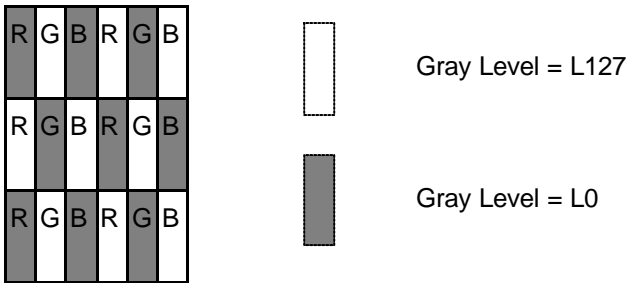

Method: Record dBV & DC value with (WESTAR)TRD-100

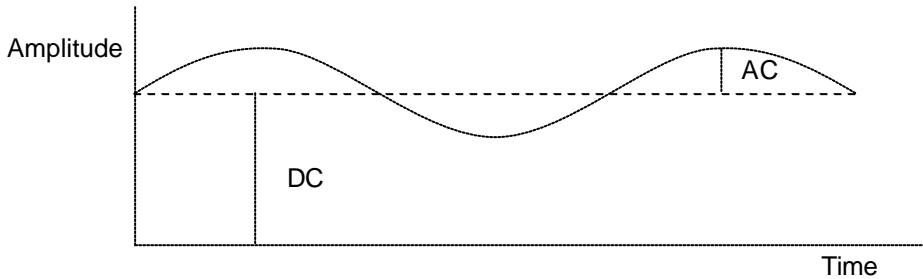

$$\text{Flicker (dB)} = 20 \log \frac{\text{AC Level(at 30 Hz)}}{\text{DC Level}}$$



### 3.0 Functional Block Diagram

The following diagram shows the functional block of the 19.0 inches Color TFT/LCD Module:

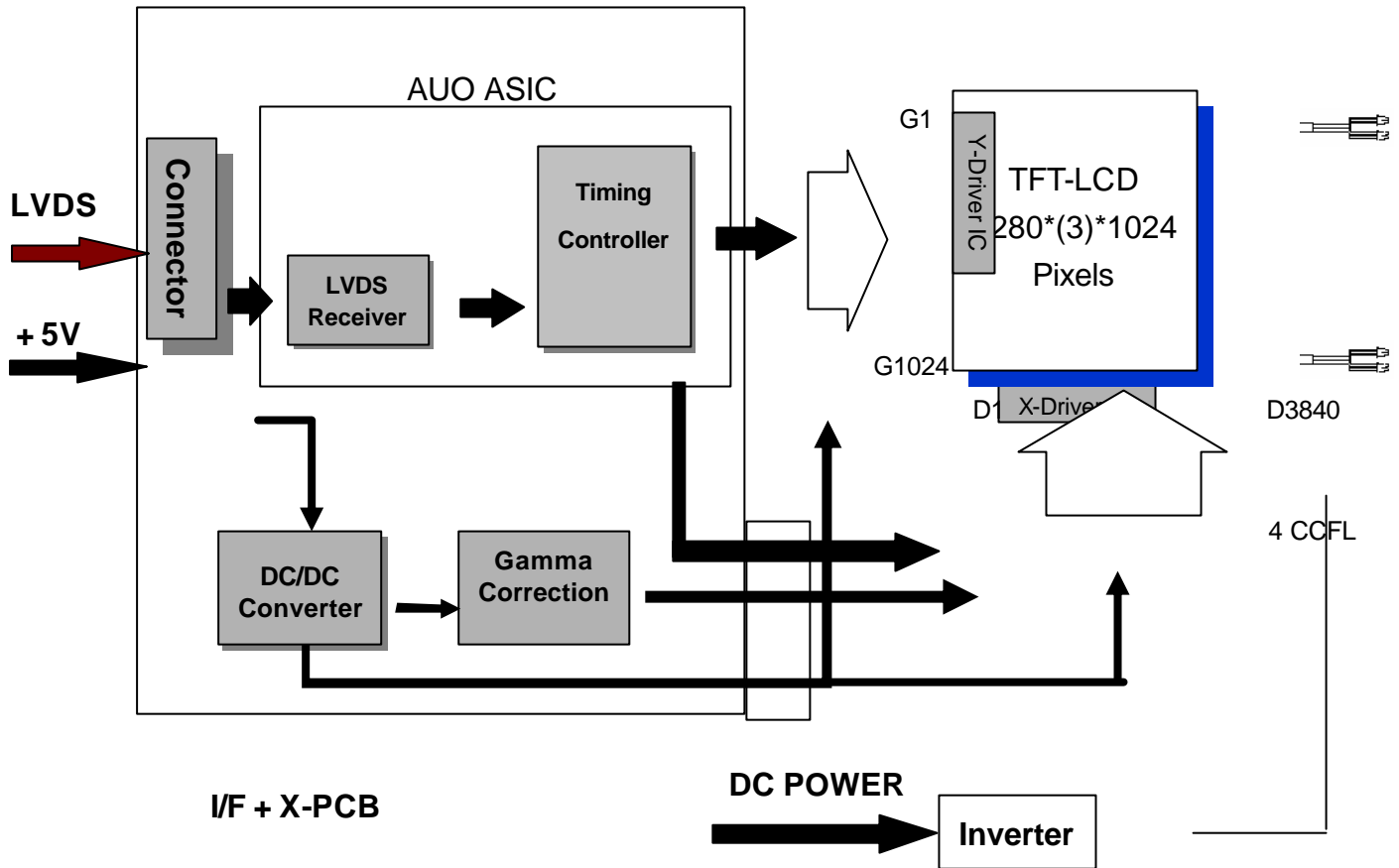

JAE FI-XB30SL-HF10

JST BHSR-02VS-1

Mating Type:

JAE FI-X30HL-T ( Locked Type )

JAE FI-X30S-H ( Unlocked Type )

Mating Type:

SM02B-BHSS-1-TB



## 4.0 Absolute Maximum Ratings

Absolute maximum ratings of the module is as following:

### 4.1 TFT LCD Module

Item	Symbol	Min	Max	Unit	Conditions
Logic/LCD Drive Voltage	VIN	-0.3	+5.5	[Volt]	<b>Note 1,2</b>

### 4.2 Backlight Unit

Item	Symbol	Min	Max	Unit	Conditions
CCFL Current	ICFL	-	7.5	[mA] rms	<b>Note 1,2</b>

### 4.3 Absolute Ratings of Environment

Item	Symbol	Min	Max	Unit	Conditions
Operating Humidity	HOP	8	95	[%RH]	<b>Note 3</b>
Storage Temperature	TST	-20	+60	[°C]	<b>Note 3</b>
Storage Humidity	HST	8	95	[%RH]	<b>Note 3</b>

**Note 1:** With in Ta (25 )

**Note 2:** Permanent damage to the device may occur if exceed maximum values

**Note 3:** For quality performance, please refer to AUO IIS(Incoming Inspection Standard).

#### Relative Humidity %

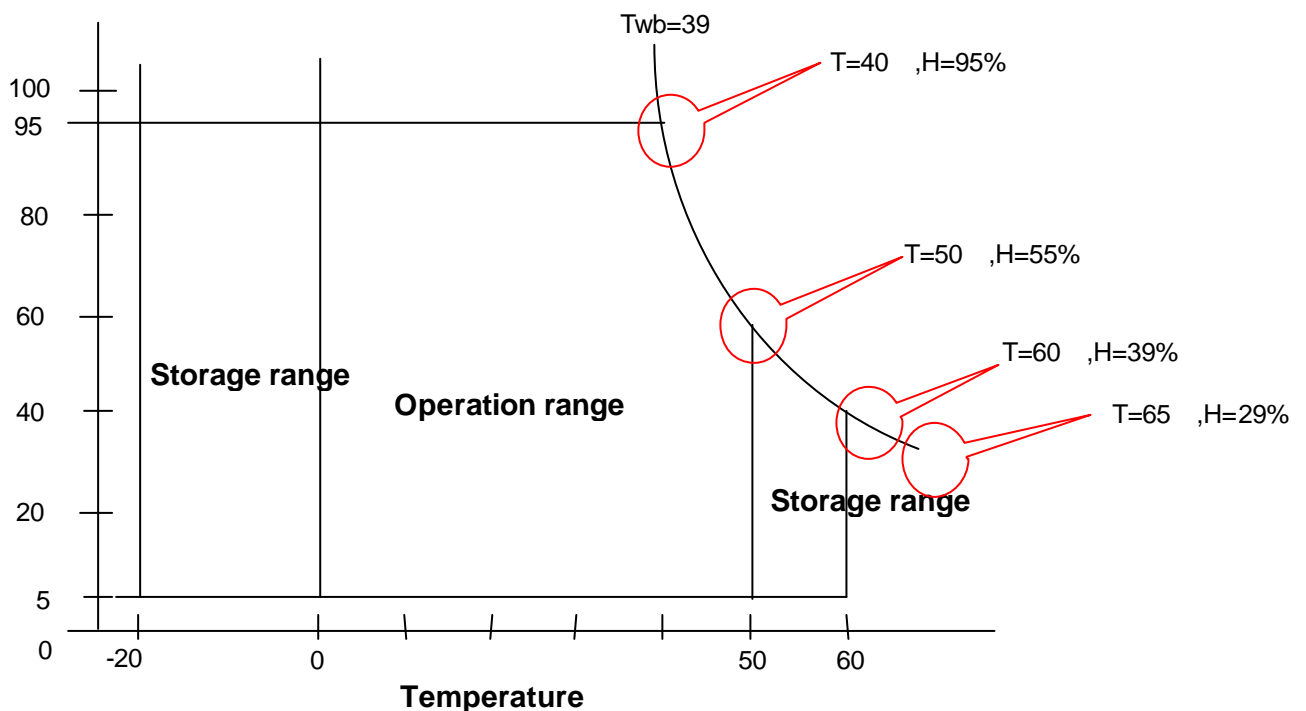



## 5.0 Electrical characteristics

### 5.1 TFT LCD Module

#### 5.1.1 Power Specification

Input power specifications are as follows;

Symbol	Parameter	Min	Typ	Max	Units	Condition
VDD	Logic/LCD Drive Voltage	4.5	5	5.5	[Volt]	± 10%
IDD	VDD current	-	TBD	TBD	[mA]	V <sub>in</sub> =5V , All White Pattern, +30%, at 75Hz
I <sub>rush</sub>	LCD Inrush Current	-	-	7	[A]	<b>Note</b>
PDD	VDD Power	-		8	[Watt]	V <sub>in</sub> =5V , All White Pattern, +30%, at 75Hz
VDD <sub>rp</sub>	Allowable Logic/LCD Drive Ripple Voltage			100	[mV] p-p	
VDD <sub>ns</sub>	Allowable Logic/LCD Drive Ripple Voltage			100	[mV] p-p	

**Note:** Measurement conditions:

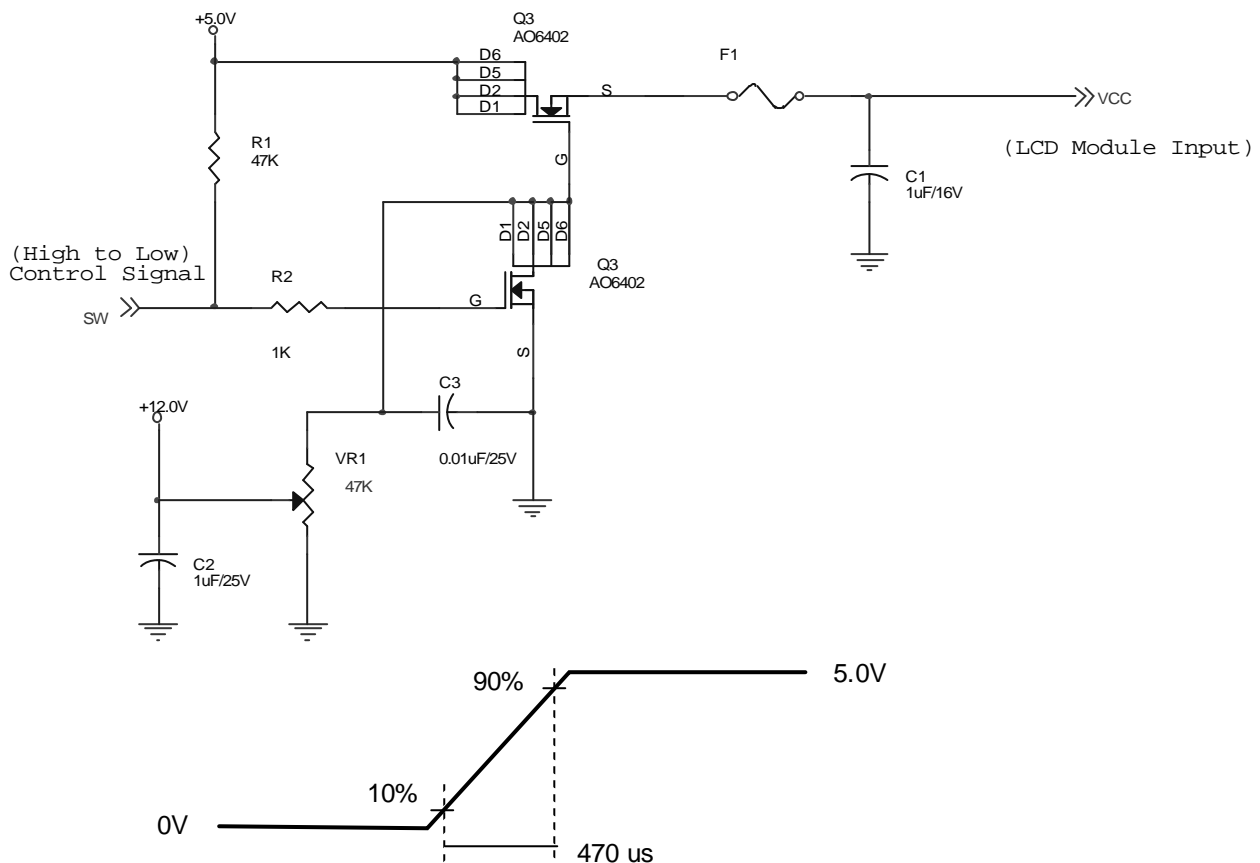

#### V<sub>in</sub> rising time



## 5.1.2 Signal Electrical Characteristics

Input signals shall be low or Hi-Z state when  $V_{in}$  is off

It is recommended to refer the specifications of SN75LVDS82DGG (Texas Instruments) in detail.

Each signal characteristics are as follows;

Symbol	Parameter	Min	Typ	Max	Units	Condition
$V_{TH}$	Differential Input High Threshold	-	-	+100	[mV]	$V_{ICM} = 1.2V$ <b>Note</b>
$V_{TL}$	Differential Input Low Threshold	-100	-	-	[mV]	$V_{ICM} = 1.2V$ <b>Note</b>
$ VID $	Input Differential Voltage	100	400	600	[mV]	<b>Note</b>
$V_{ICM}$	Differential Input Common Mode Voltage	+1.0	+1.2	+1.35	[V]	$V_{TH}/V_{TL} = \pm 100mV$ <b>Note</b>

**Note:** LVDS Signal Waveform

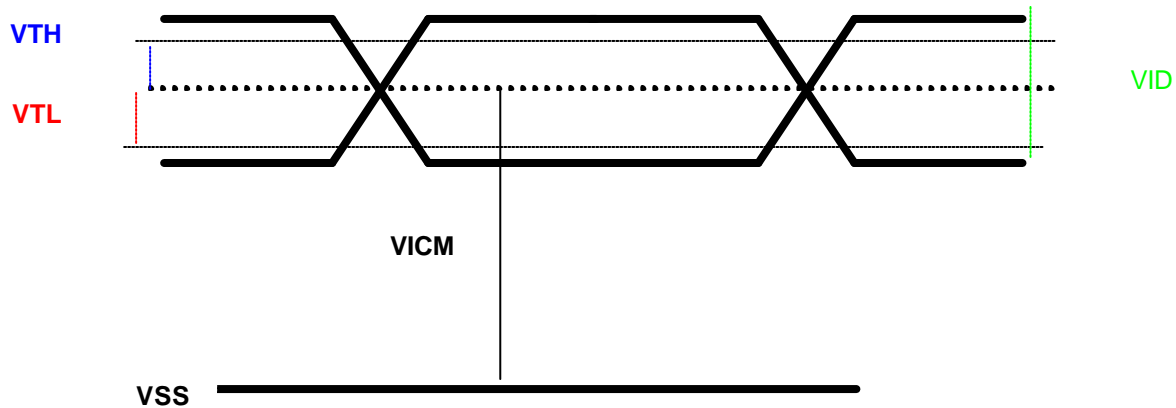



## 5.2 Backlight Unit

Parameter guideline for CCFL Inverter

Symbol	Parameter	Min.	Typ.	Max.	Unit	Condition
ISCFL	CCFL standard current	6.5	7.0	7.5	[mA] rms	(Ta=25°C) <b>Note 1</b>
IRCFL	CCFL operation range	3.0	7.0	7.5	[mA] rms	(Ta=25°C)
FCFL	CCFL Frequency	40	50	60	[KHz]	(Ta=25°C) <b>Note 2</b>
ViCFL (0°C)	CCFL Ignition Voltage (End of the lamp wire connector)	1810	-	-	[Volt] rms	(Ta=0°C) <b>Note 3</b>
ViCF (25°C)	CCFL Ignition Voltage (End of the lamp wire connector)	1540	-	-	[Volt] rms	(Ta=25°C) <b>Note 3</b>
VCFL	CCFL Operation Voltage	-	750 @7mA	800	[Volt] rms	(Ta=25°C) <b>Note 4</b>
PCFL	CCFL Power consumption (for reference)	-	21	23.1	[Watt]	(Ta=25°C) <b>Note 5</b>
LTCFL	CCFL life Time	40,000	50,000	-	[Hour]	(Ta=25°C) <b>Note 6</b>

**Note 1:** CCFL standard current is measured at 25 ±2 ..

**Note 2:** CCFL Frequency should be carefully determined to avoid interference between inverter and TFT LCD

**Note 3:** ViCFL means Ignition Voltage for both ends of the lamp, and CCFL inverter should be able to give out a power that has a generating capacity of over 1810 voltage. Lamp units need 1810 voltage minimum for ignition

**Note 4:** CCFL operation voltage is measured at 25 ±2 ..

**Note 5:** The variance of CCFL power consumption is ± 10%. Calculator value for reference (ICFL×VCFL×4=PCFL).

**Note 6:** Definition of life: brightness becomes 50% or less than the minimum luminance value of CCFL..The typical life time of CCFL is on the condition at 7.0mA lamp current.



## 6.0 Signal Characteristic

### 6.1 Pixel Format Image

Following figure shows the relationship of the input signals and LCD pixel format.

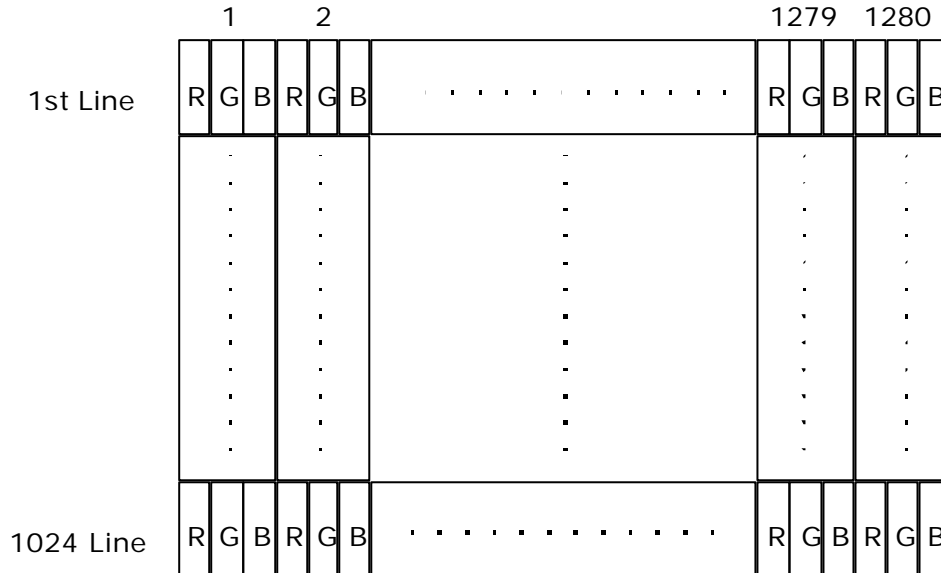

### 6.2 The input data format

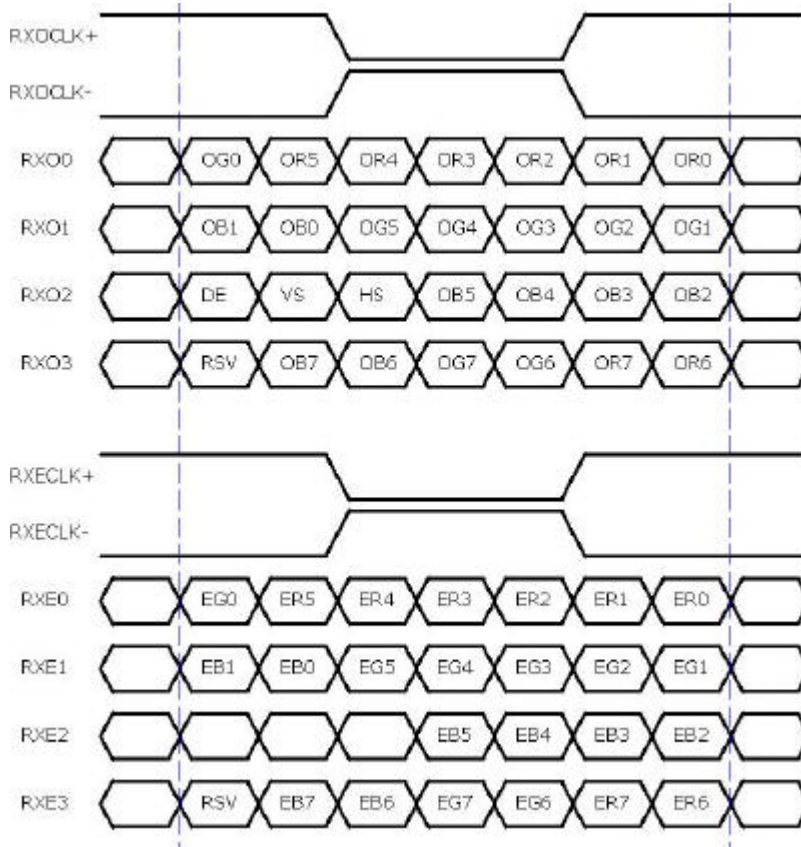

**Note 1:** R/G/B data 7:MSB, R/G/B data 0:LSB  
 O = "First Pixel Data"  
 E = "Second Pixel Data"





### 6.3 Signal Description

The module using one LVDS receiver SN75LVDS82(Texas Instruments) or compatible. LVDS is a differential signal technology for LCD interface and high speed data transfer device. Transmitter shall be SN75LVDS83(negative edge sampling) or compatible. The first LVDS port(RxOxxx) transmits odd pixels while the second LVDS port(RxExxx) transmits even pixels.

PIN #	SIGNAL NAME	DESCRIPTION
1	RxO0-	Negative LVDS differential data input (Odd data)
2	RxO0+	Positive LVDS differential data input (Odd data)
3	RxO1-	Negative LVDS differential data input (Odd data)
4	RxO1+	Positive LVDS differential data input (Odd data)
5	RxO2-	Negative LVDS differential data input (Odd data, H-Sync,V-Sync,DSPTMG)
6	RxO2+	Positive LVDS differential data input (Odd data, H-Sync,V-Sync,DSPTMG)
7	GND	Power Ground
8	RxOC-	Negative LVDS differential clock input (Odd clock)
9	RxOC+	Positive LVDS differential clock input (Odd clock)
10	RxO3-	Negative LVDS differential data input (Odd data)
11	RxO3+	Positive LVDS differential data input (Odd data)
12	RxE0-	Negative LVDS differential data input (Even clock)
13	RxE0+	Positive LVDS differential data input (Even data)
14	GND	Power Ground
15	RxE1-	Positive LVDS differential data input (Even data)
16	RxE1+	Negative LVDS differential data input (Even data)
17	GND	Power Ground
18	RxE2-	Negative LVDS differential data input (Even data)
19	RxE2+	Positive LVDS differential data input (Even data)
20	RxEC-	Negative LVDS differential clock input (Even clock)
21	RxEC+	Positive LVDS differential clock input (Even clock)
22	RxE3-	Negative LVDS differential data input (Even data)
23	RxE3+	Positive LVDS differential data input (Even data)
24	GND	Power Ground
25	NC	-
26	NC	-
27	NC	-
28	POWER	Power
29	POWER	Power
30	POWER	Power



**Note1:** Start from left side

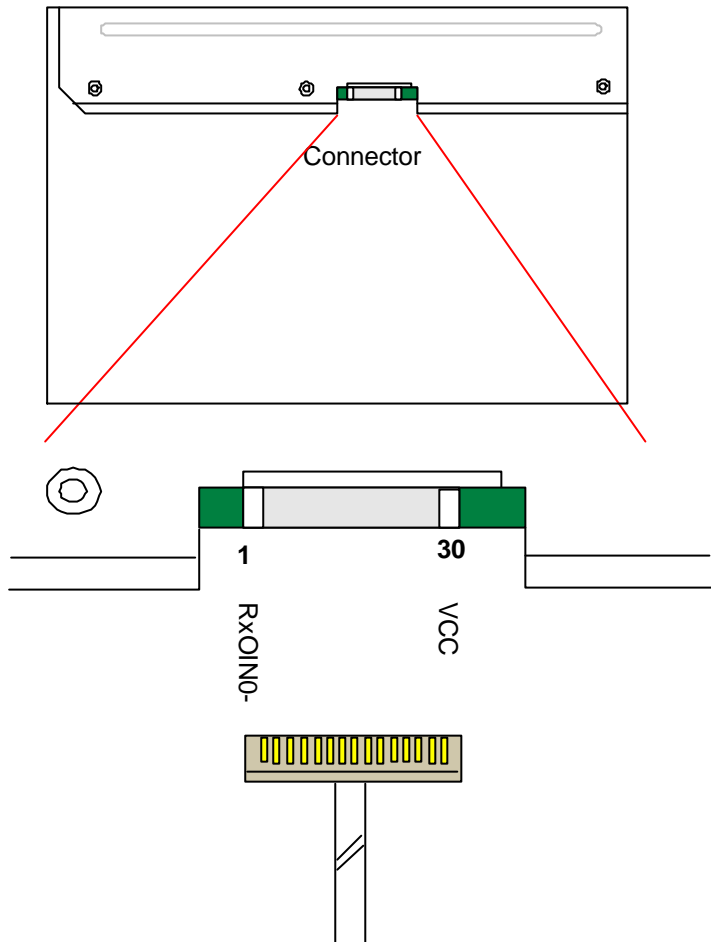

**Note2:** Input signals of odd and even clock shall be the same timing.



## 6.4.1 Timing Characteristics

Basically, interface timings described here is not actual input timing of LCD module but output timing of SN75LVDS82DGG (Texas Instruments) or equivalent. **Note:** Typical value refer to VESA STANDARD

Signal	Item	Symbol	MIN	TYP	MAX	Unit
DTCLK	Freq.	Fdck	50	67.5	70	MHz
DTCLK	Cycle	Tck	14.2	14.8	20	ns
+V-Sync	Frame Rate	1/Tv	56.25	75	77	Hz
+V-Sync	Cycle	Tv	13	13.33	17.78	ms
+V-Sync	Cycle	Tv	1035	1066	2047	lines
+V-Sync	Active level	Tva	3	3		lines
+V-Sync	V-back porch	Tvb	7	38	63	lines
+V-Sync	V-front porch	Tvf	1	1		lines
+DSPTMG	V-Line	m	-	1024	-	lines
+H-Sync	Scan rate	1/Th	-	80.06	-	KHz
+H-Sync	Cycle	Th	800	844	1023	Tck
+H-Sync	Active level	Tha (*1)	4	56		Tck
+H-Sync	Back porch	Thb (*1)	4	124		Tck
+H-Sync	Front porch	Thf	4	24		Tck
+DSPTMG	Display Pixels	n	-	640	-	Tck

## 6.4.2 Timing diagram

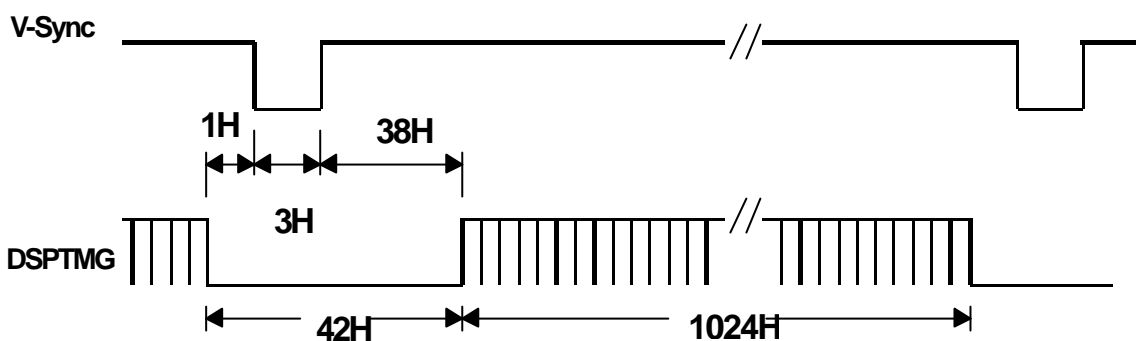
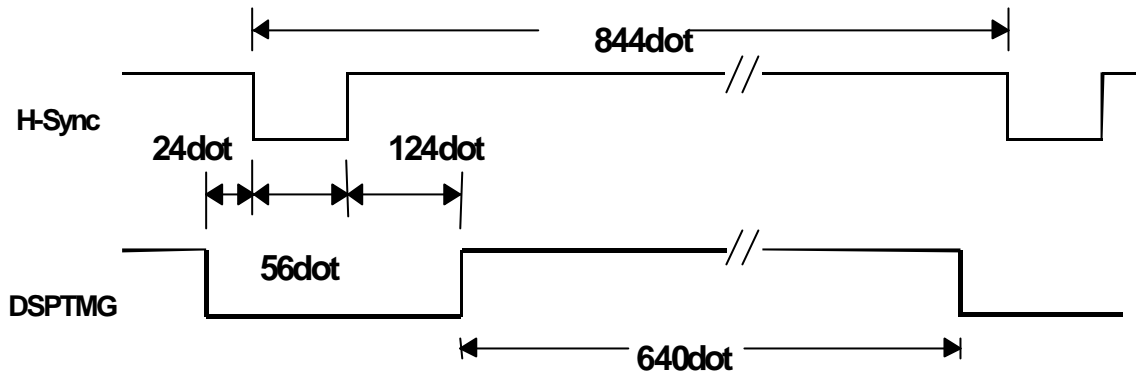



## 6.5 Power ON/OFF Sequence

Vin power and lamp on/off sequence is as follows. Interface signals are also shown in the chart. Signals from any system shall be Hi-Z state or low level when Vin is off.

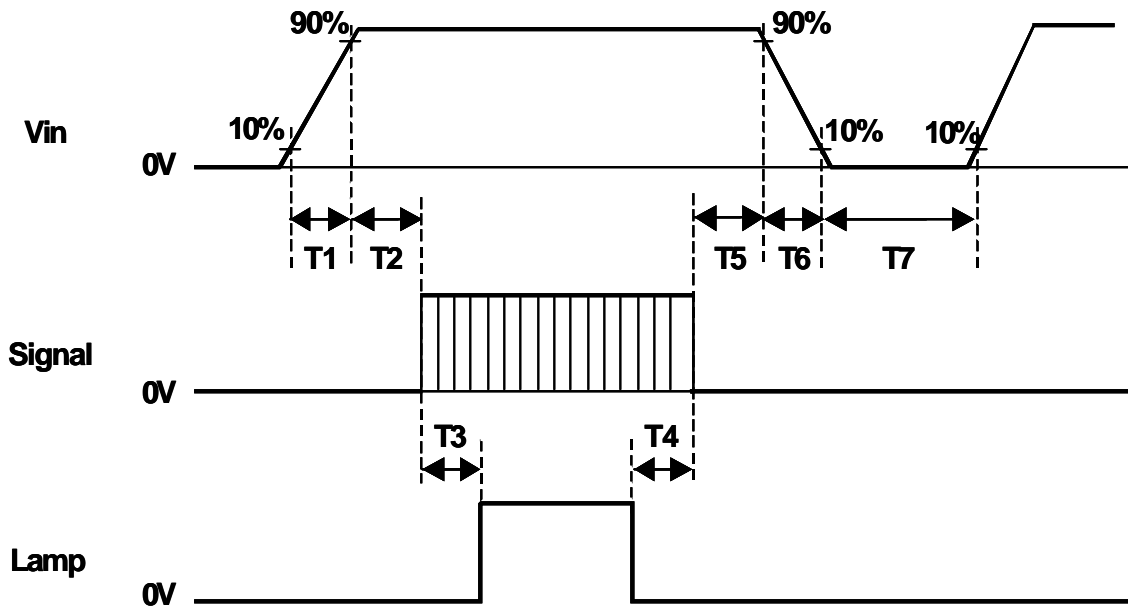

Symbol	Values			Unit
	Min	Typ	Max	
T1	0	-	10	[ms]
T2	0.5	40	50	[ms]
T3	300	-	-	[ms]
T4	300	-	-	[ms]
T5	0.5	16	50	[ms]
T6	0.5	-	10	[ms]
T7	1000	-	-	[ms]



## 7.0 Connector & Pin Assignment

Physical interface is described as for the connector on module.

These connectors are capable of accommodating the following signals and will be following components.

### 7.1 TFT LCD Module

<b>Connector Name / Designation</b>	Interface Connector / Interface card
<b>Manufacturer</b>	JAE or compatible
<b>Type Part Number</b>	FI-XB30SL-HF10
<b>Mating Housing Part Number</b>	FI-X30HL-T ( Locked Type ) FI-X30S-H ( Unlocked Type )

Pin#	Signal Name	Pin#	Signal Name
1	RxO0-	2	RxO0+
3	RxO1-	4	RxO1+
5	RxO2-	6	RxO2+
7	GND	8	RxOC-
9	RxOC+	10	RxO3-
11	RxO3+	12	RxE0-
13	RxE0+	14	GND
15	RxE1-	16	RxE1+
17	GND	18	RxE2-
19	RxE2+	20	RxEC-
21	RxEC+	22	RxE3-
23	RxE3+	24	GND
25	NC	26	NC
27	NC	28	Power
29	Power	30	Power



## 7.2 Backlight Unit

Connector Name / Designation	Lamp Connector / Backlight lamp
Manufacturer	JST
Type Part Number	BHSR-02VS-1
Mating Type Part Number	SM02B-BHSS-1-TB

## 7.3 Signal for Lamp connector

	Connector No.	Pin No.	Input	Color	Function
Upper	CN1	1	Hot1	Pink	High Voltage
		2	Cold1	White	Low Voltage
	CN2	1	Hot2	Pink	High Voltage
		2	Cold2	White	Low Voltage
Lower	CN3	1	Hot1	Pink	High Voltage
		2	Cold1	White	Low Voltage
	CN4	1	Hot2	Pink	High Voltage
		2	Cold2	White	Low Voltage

## 8.0 Vibration, Shock, and Drop

### 8.1 Vibration & Shock

#### Vibration Test Spec:

- Frequency: 10 - 200Hz
- Sweep: 30 Minutes each Axis (X, Y, Z)
- Acceleration: 1.5G(10~200Hz P- P)
- Test method:

Acceleration (G)	1.5
Frequency (Hz)	10~200~10
Active time (min)	30

#### Shock Test Spec:

Acceleration (G) -a	50
Active time -b	20 ms
Wave form	Half-sin
Times	1

- Direction:  $\pm X$ ,  $\pm Y$ ,  $\pm Z$

### 8.2 Drop test

Package test: The drop height is 60cm.



## 9.0 Environment

The display module will meet the provision of this specification during operating condition or after storage or shipment condition specified below. Operation at 10% beyond the specified range will not cause physical damage to the unit.

### 9.1 Temperature and Humidity

#### 9.1.1 Operating Conditions

The display module operates error free, when operated under the following conditions;

Temperature	0 °C to 50 °C
Relative Humidity	8% to 95%
Wet Bulb Temperature	39.0 °C

#### 9.1.2 Shipping Conditions

The display module operates error free, after the following conditions;

Temperature	-20 °C to 60 °C
Relative Humidity	8% to 95%
Wet Bulb Temperature	39.0 °C

### 9.2 Atmospheric Pressure

The display assembly is capable of being operated without affecting its operations over the pressure range as following specified;

	Pressure	Note
Maximum Pressure	1040hPa	0m = sea level
Minimum Pressure	674hPa	3048m = 10.000 feet

Note : Non-operation attitude limit of this display module = 30,000 feet. = 9145 m.

### 9.3 Thermal Shock

The display module will not sustain damage after being subjected to 100 cycles of rapid temperature change. A cycle of rapid temperature change consists of varying the temperature from -20°C to 60°C, and back again.

<b>Thermal shock cycle</b>	-20 °C for 30min
	60 °C for 30min

Power is not applied during the test. After temperature cycling, the unit is placed in normal room ambient for at least 4 hours before powering on.



## 10.0 Reliability

This display module and the packaging of that will comply following standards.

### 10.1 Failure Criteria

The display assembly will be considered as failing unit when it no longer meets any of the requirements stated in this specification. Only as for maximum white luminance, following criteria is applicable.

- **Maximum white Luminance shall be 125cd/m<sup>2</sup> or more.**

### 10.2 Failure Rate

The average failure rate of the display module (from first power-on cycle till 1,000 hours later) will not exceed 1.0%. The average failure rate of the display module from 1,000 hours until 16,000 hours will not exceed 0.7% per 1000 hours.

#### 10.2.1 Usage

The assumed usage for the above criteria is:

- 220 power-on hours per month
- 500 power on/off cycles per month
- Maximum brightness setting
- Operation to be within office environment (25°C typical)

#### 10.2.1 Component De-rating

All the components used in this device will be checked the load condition to meet the failure rate criteria.

### 10.3 On/OFF Cycle

The display module will be capable of being operated over the following ON/OFF Cycles.

ON/OFF	Value	Cycles
+Vin and CCFL power	30,000	10 seconds on / 10 seconds off





## 11.0 Safety

### 11.1 Sharp Edge Requirements

There will be no sharp edges or comers on the display assembly that could cause injury.

### 11.2 Materials

#### 11.2.1 Toxicity

There will be no carcinogenic materials used anywhere in the display module. If toxic materials are used, they will be reviewed and approved by the responsible ADT Toxicologist.

#### 11.2.2 Flammability

All components including electrical components that do not meet the flammability grade UL94-V1 in the module will complete the flammability rating exception approval process.

The printed circuit board will be made from material rated 94-V1 or better. The actual UL flammability rating will be printed on the printed circuit board.

### 11.3 Capacitors

If any polarized capacitors are used in the display assembly, provisions will be made to keep them from being inserted backwards.

## 12.0 Other requirement

### 12.1 National Test Lab Requirement

The display module will satisfy all requirements for compliance to

**UL 1950, First Edition**  
**CSA C22.2 No.950-M89**  
**EEC 950**  
**EN 60 950**

U.S.A. Information Technology Equipment  
 Canada, Information Technology Equipment  
 International, Information Technology Equipment  
 International, Information Processing Equipment  
 (European Norm for IEC950)

### 12.2 Label

The label is on the panel as shown below:

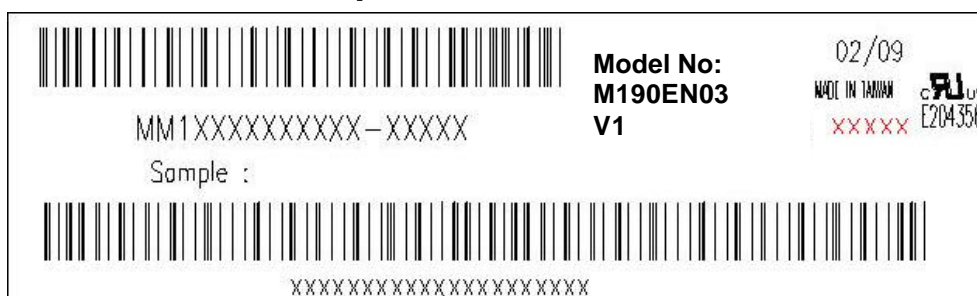

### 13.0 Mechanical Characteristics

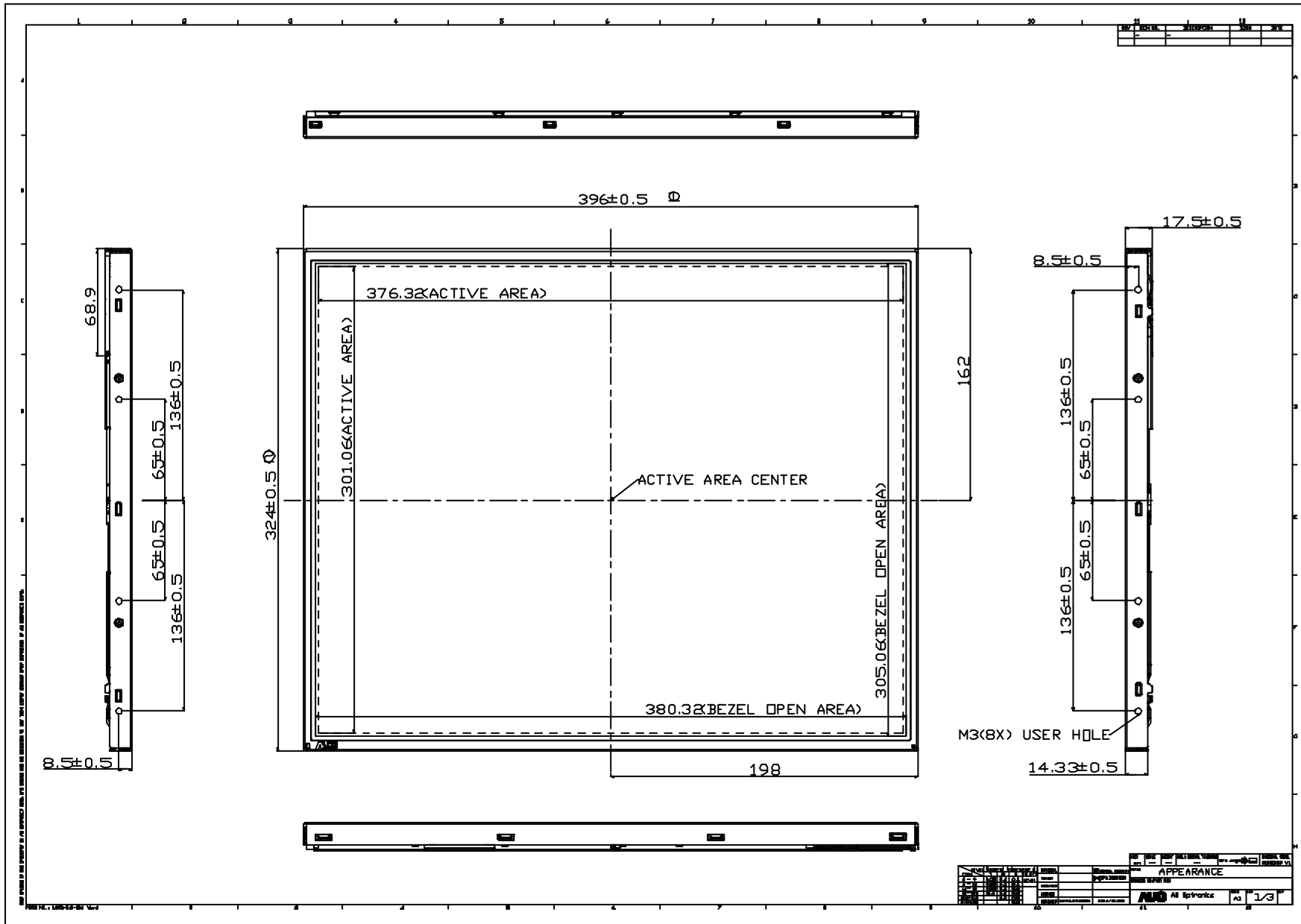

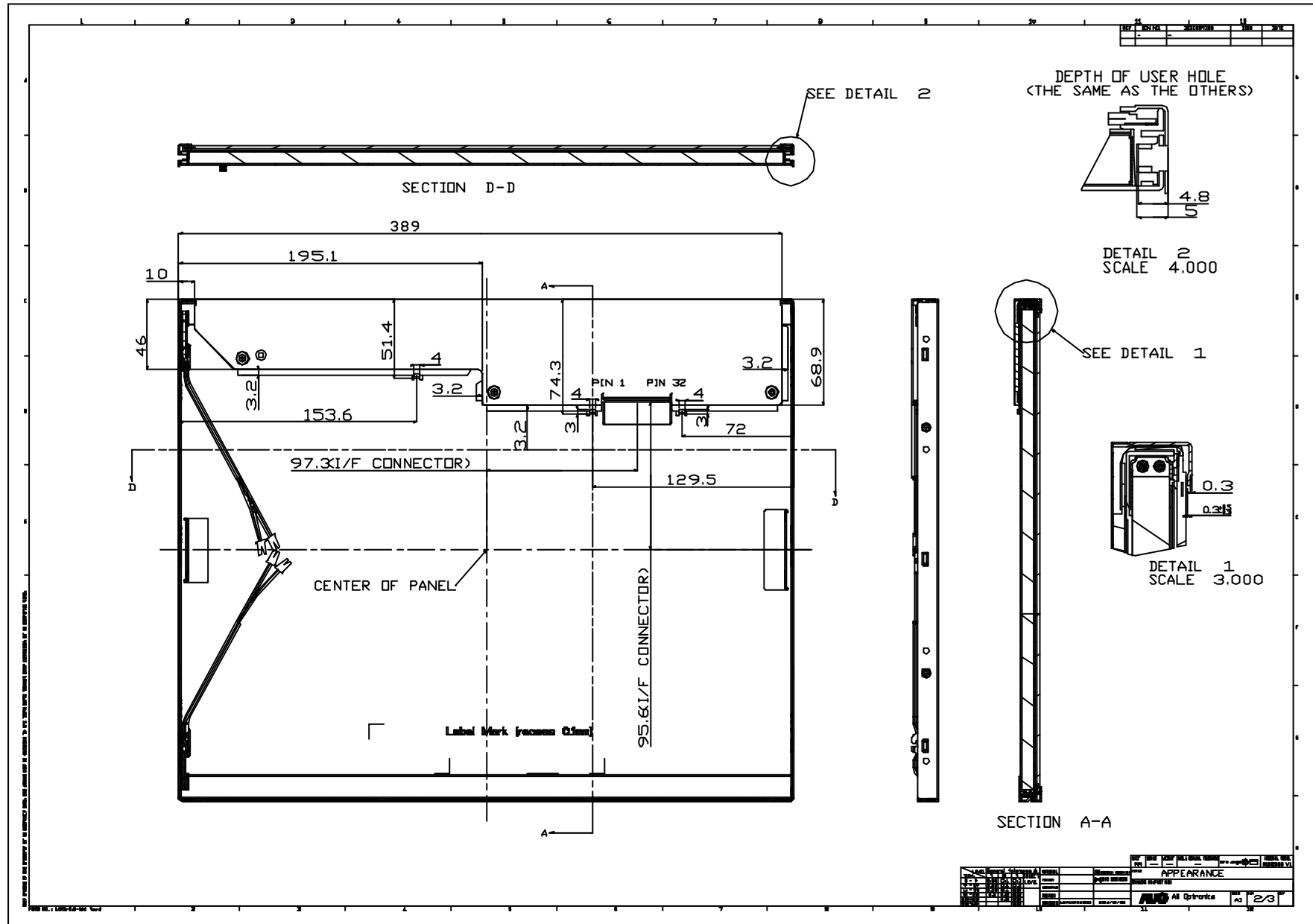

NOTE:

- 1.PRELIMINARY DRAWING FOR REFERENCE ONLY.
- 2.THE DIMENSION EXCLUDES DEFORMATION.
- 3.MODULE THICKNESS SHOULD BE 18mm MAX.
- 4.TOLERANCE WITHOUT NOTICED TO BE ±0.5mm.
- 5.LAMP CABLE CONNECTOR TO BE JST BHSR-02VS-1
- 6.I/F CONNECTOR TO BE JAE FI-XB30SL-HF10.
- 7.M3 USER HOLE SCREW TORQUE 4.0kg-cm MAX.
- 8.USER HOLE SCREW PENETRATION 4.5mm MAX.
- 9.DIMENSION TOLERANCE,ABSOLUTE VALUES OF A-B AND C-D MAX MUST BE 1.0
- 10.CABLE LENGTH FROM CONSTRAIN TO FREE END MUST BE 130±10 mm

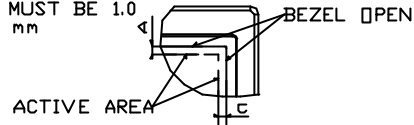

DETAIL A  
SCALE 2.000

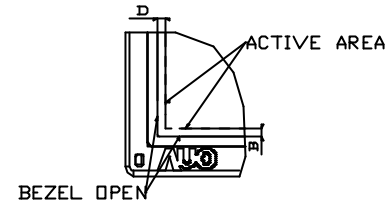

CHECK NOTE 9  
DETAIL B  
SCALE 2.000

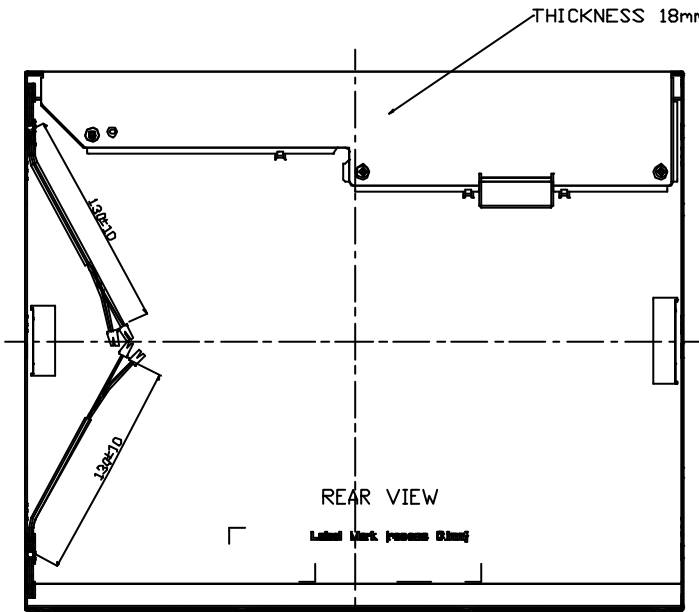

SCALE 0.800

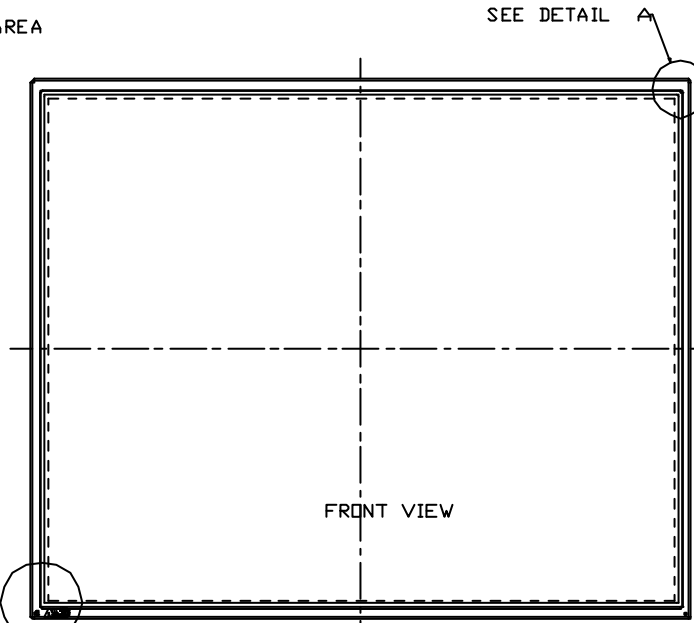

SCALE 0.800

SEE DETAIL B

PROJECT TITLE		DATE	SCALE
PROJECT NO.		DESIGNER	DATE
DRAWING NO.		CHECKER	DATE
REVISIONS		APPROVER	DATE
MATERIALS		All Electronics	