

Document Version: 0.4
Date: 2005/11/11

Product Functional Specification

20.1 inch WSXGA+ Color TFT LCD Module
Model Name: M201EW01 V2

Preliminary Specification
 Final Specification

Note: This Specification is subject to change without notice.

AU OPTRONICS CORPORATION

Product Specification

20.1" Wide SXGA+ Color TFT-LCD Module

Model Name: M201EW01 V.2

Approved by	Prepared by

DDBU Marketing Division / AU Optronics corporation

Customer	Checked & Approved by

Contents

1.0 Handling Precautions.....	7
2.0 General Description	8
2.1 Display Characteristics	8
2.2 Optical Characteristics	9
3.0 Functional Block Diagram	13
4.0 Absolute Maximum Ratings.....	14
4.1 TFT LCD Module	14
4.2 Backlight Unit	14
4.3 Absolute Ratings of Environment.....	14
5.0 Electrical characteristics	15
5.1 TFT LCD Module	15
5.1.1 Power Specification.....	15
5.1.2 Signal Electrical Characteristics.....	16
5.2 Backlight Unit	17
6.0 Signal Characteristic.....	18
6.1 Pixel Format Image.....	18
6.2 The input data format	19
6.3 Signal Description	20
6.4 Timing Characteristics.....	21
6.4.1 Timing diagram	22
6.5 Power ON/OFF Sequence.....	23
7.0 Connector & Pin Assignment.....	24
7.1 TFT LCD Module	24
7.2 Backlight Unit	25
7.3 Signal for Lamp connector.....	25
8.0 Reliability	27
9.0 Environment	28
9.1 Temperature and Humidity.....	28
9.1.1 Operating Conditions	28
9.1.2 Shipping Conditions	28
9.2 Atmospheric Pressure	28
10.0 Safety	29
10.1 Sharp Edge Requirements	29
10.2 Materials.....	29
10.2.1 Toxicity	29
10.2.2 Flammability	29

10.3 Capacitors 29

11.0 Other requirement 30

11.1 National Test Lab Requirement 30

11.2 Label 30

12.0 Mechanical Characteristics..... 31

Record of Revision

Version and Date	Page	Old description	New Description	Remark
0.1 2004/05/13	All	First Edition for Customer	All	
0.2 2005/05/11	29	11.2 Label (without TUV logo)	11.2 Label (with TUV logo)	Modified
	27	10.0 Reliability	NA	Removed
	26	NA	Drop test	Added
	7	TCO'03 compliance	NA	Removed
	7	2.1 Screen Diagonal 510.54mm	2.1 Screen Diagonal 511.13mm	Modified
	7	2.1 Response Time 20ms (Typ. On/Off)	2.1 Response Time 16ms (Typ. On/Off)	Modified
	8	2.2 Rising Time 15ms (Typ.)	2.2 Rising Time 11ms (Typ.)	Modified
	8	2.2 Rising+Falling 20ms (Typ.)	2.2 Rising+Falling 16ms (Typ.)	Modified
	16	5.2 IRCFL-CCFL Operation range 6.5 (Max.)	5.2 IRCFL-CCFL Operation range 8.0 (Max.)	Modified
	16	5.2 ViCFL(0°C)- CCFL Ignition voltage 1400(Min.)	5.2 ViCFL(0°C)- CCFL Ignition voltage 1500(Min.)	Modified
	16	5.2 ViCF(25°C)- CCFL Ignition voltage 1200(Min.)	5.2 ViCFL(25°C)- CCFL Ignition voltage 1150(Min.)	Modified
	16	5.2 VCFL-CCFL Operation voltage 765@6.5mA(Min.)	5.2 VCFL-CCFL Operation voltage 740@8mA(Min.)	Modified
	16	5.2 PCFL-CCFL power consumption 15(Max.)	NA	Modified
	20	NA	6.4 Vertical Section-Period 1087(Typ.) -Blanking 37(Typ.)	Modified
	20	NA	6.4 Horizontal Section-Period 1128(Typ.) -Blanking 288(Typ.)	Modified
	20	6.4 Clock Period- Min: 12; Typ: NA; Max: NA Frequency-Min: NA ; Max:85(MHz)	6.4 Clock Period- Min: 12.3; Typ: 13.6; Max: 16.67 Frequency-Min: 60; Max:81(MHz)	Modified
	8	2.1 Weight 3100 grams (Max)	2.1 Weight 2950 grams (Typ)	Modified
	9	2.2 Viewing angle 85/85/85/85 (Typ)	2.2 Viewing angle 88/88/88/88 (Typ)	Modified
	9	2.2 White lux@CCFL 6.0mA 250cd/m ² (Min)	2.2 White lux@CCFL 6.0mA 240cd/m ² (Min)	Modified
	14	4.1 LCD Drive Voltage +5.5V (Max)	4.1 LCD Drive Voltage 6V (Max)	Modified
	14	4.2 CCFL Current 6.5mA (Max)	4.2 CCFL Current 8 mA (Max)	Modified
	15	5.1.1 VDD current 1200mA (Typ)	5.1.1 VDD current 1300mA (Typ)	Modified

	15	5.1.1 VDD power NA(Typ); 8(Max)	5.1.1 VDD power 6.5(Typ); 7(Max)	Modified
	15	5.1.1 VDDns 100 (Max)	NA	Removed
	17	5.2 ViCFL (0°C) 1500V(Min)	5.2 ViCFL (0°C) 1950V(Min)	Modified
	17	5.2 ViCFL (25°C) 1150V(Min)	5.2 ViCFL (25°C) 1495V(Min)	Modified
	17	5.2 LTCFL 40,000hrs(Min); 50,000hrs(Typ)	5.2 LTCFL 50,000hrs(Min); 60,000hrs(Typ)	Modified
	20	6.3 PIN 25/26/27 (Description: NA)	6.3 PIN 25/26/27 (Description: For AUO test only)	Modified
	21	NA	6.4 Frame rate	Added
	23	6.5 T1: 0ms (Min); T6: 0.5ms (Min)	6.5 T1: 0.5ms (Min); T6: NIL	Modified
	30	11.2 Label (with TUV logo)	11.2 Label (without TUV logo)	Modified
	9	2.2 Response Time: 12ms GTG (Avg.)	2.2 Response Time: 8ms GTG (Avg.)	Modified
0.3 2005/11/07	9	2.2 Brightness uniformity: Min: 70%; Typ: 75%	2.2 Brightness uniformity: Min: 75%; Typ: 80%	Modified
	10			Modified
0.4 2005/11/11	8	NA	RoHS compliance	Added

1.0 Handling Precautions

- 1) Since front polarizer is easily damaged, pay attention not to scratch it.
- 2) Be sure to turn off power supply when inserting or disconnecting from input connector.
- 3) Wipe off water drop immediately. Long contact with water may cause discoloration or spots.
- 4) When the panel surface is soiled, wipe it with absorbent cotton or other soft cloth.
- 5) Since the panel is made of glass, it may break or crack if dropped or bumped on hard surface.
- 6) Since CMOS LSI is used in this module, take care of static electricity and insure human earth when handling.
- 7) Do not open nor modify the Module Assembly.
- 8) Do not press or pat the panel surface by fingers, hand or tooling
- 9) Do not press the reflector sheet at the back of the module to any directions.
- 10) In case if a module has to be put back into the packing container slot after once it was taken out from the container, do not press the center of the CCFL reflector edge. Instead, press at the far ends of the CCFL reflector edge softly. Otherwise the TFT module may be damaged.
- 11) At the insertion or removal of the Signal Interface Connector, be sure not to rotate nor tilt the Interface Connector of the TFT module.
- 12) After installation of the TFT module into an enclosure (Desktop monitor Bezel, for example), do not twist nor bend the TFT Module even momentary. At designing the enclosure, it should be taken into consideration that no bending/twisting forces are applied to the TFT module from outside. Otherwise the TFT module may be damaged.

2.0 General Description

This specification applies to the 20.1 inch-wide Color TFT-LCD Module M201EW01.

The display supports the WSXGA+ (1680(H) x 1050(V)) screen format and 16.7M colors (RGB 8-bits data).

All input signals are 2 Channel LVDS interface compatible.

This module does not contain an inverter card for backlight.

2.1 Display Characteristics

The following items are characteristics summary on the table under 25 °C condition:

ITEMS	Unit	SPECIFICATIONS
Screen Diagonal	[mm]	511.13 (20.1"Wide)
Active Area	[mm]	433.44 (H) x 270.90(V)
Pixels H x V		1680(x3) x 1050
Pixel Pitch	[mm]	0.258 (per one triad) x 0.258
Pixel Arrangement		R.G.B. Vertical Stripe
Display Mode		Normally Black
White Luminance (Center)	[cd/m ²]	300 cd/m ² @6mA (Typ)
Contrast Ratio		800 : 1 (Typ)
Optical Response Time	[msec]	16ms (Typ, on/off) ; 8ms (Average, grey to grey)
Color Saturation		72% NTSC
Nominal Input Voltage VDD	[Volt]	+5.0 V
Power Consumption (VDD line + CCFL line)	[Watt]	30W(Typ) (w/o Inverter, All white pattern)
Weight	[Grams]	2950 (Typ)
Physical Size	[mm]	459.4(W) x 296.4(H) x 22.8(D) (Typ)
Electrical Interface		Even/Odd R/G/B data, 3 sync signal, Clock
Support Color		16.7M colors (RGB 8-bit data)
Temperature Range		
Operating	[°C]	0 to +50
Storage (Shipping)	[°C]	-20 to +60
Surface Treatment		Hard-coating (3H), Glare treatment
RoHS		RoHS compliance

2.2 Optical Characteristics

The optical characteristics are measured under stable conditions at 25°C:

Item	Unit	Conditions	Min.	Typ.	Max.	Note
Viewing Angle	[degree]	Horizontal (Right) CR = 10 (Left)	75	88	-	
	[degree]		75	88	-	
	[degree]	Vertical (Up) CR = 10 (Down)	75	88	-	
	[degree]		75	88	-	
Contrast ratio		Normal Direction	400	800		
Response Time	[msec]	Rising Time	-	11	25	Note 1
	[msec]	Falling Time	-	5	15	Note 1
	[msec]	Rising + Falling	-	16	40	Note 1
	[msec]	Grey to Grey (average)	-	8	-	Note 2
Color / Chromaticity Coordinates (CIE)		Red x	0.610	0.640	0.670	
		Red y	0.322	0.352	0.382	
		Green x	0.258	0.288	0.318	
		Green y	0.598	0.628	0.658	
		Blue x	0.114	0.144	0.174	
		Blue y	0.046	0.076	0.106	
Color Coordinates (CIE) White		White x	0.283	0.313	0.343	
		White y	0.299	0.329	0.359	
White Luminance at CCFL 6.0mA (central point)	[cd/m ²]		240	300	-	
Luminance Uniformity	[%]		75	80	-	Note 3
Crosstalk (in75Hz)	[%]				1.5	Note 4
Flicker	DB				-20	Note 5

Equipment: Pattern Generator, Power Supply, Digital Voltmeter, Luminance meter (PR 880, BM-5A , BM 7 ,CS-1000, & EZContrast*)

Aperture : 1° with 100cm viewing distance (VD) or 2° with 50cm viewing distance (VD)

Test Point: Center (VESA point 9)

Environment: < 1 lux

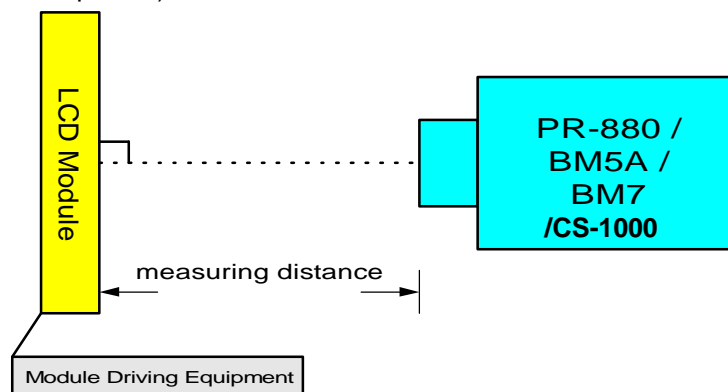

* EZ Contrast is different measurement tool with very close viewing distance.

Note 1: Definition of Response time

The output signals of photodetector are measured when the input signals are changed from “Black” to “White” (rising time), and from “White” to “Black” (falling time), respectively. The response time is interval between the 10% and 90% of amplitudes.

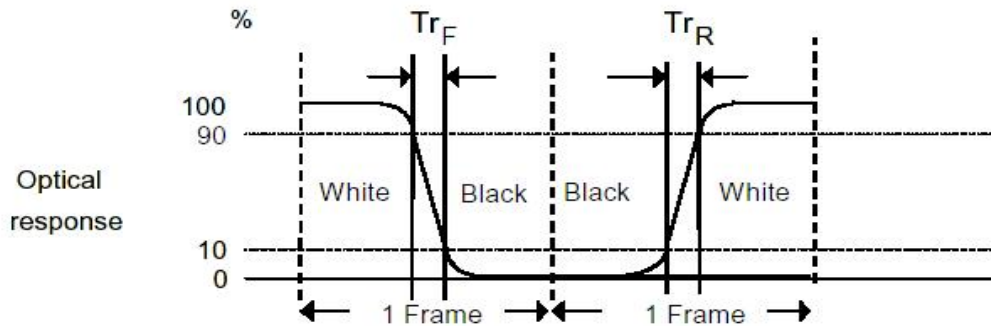

Note 2: Over-Drive and Response time:

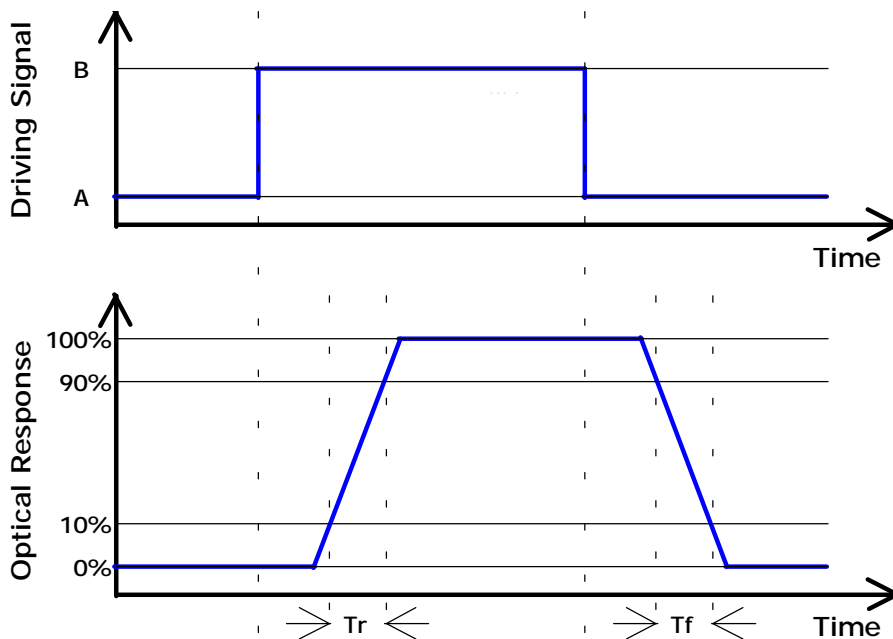

Algorithm:

$$| \text{Level A} - \text{Level B} | \geq 16 \text{ then average } Tr \leq 12\text{ms} \ \& \ \text{average } Tf \leq 12\text{ms}$$

Note 3: Brightness uniformity of these 9 points is defined as below

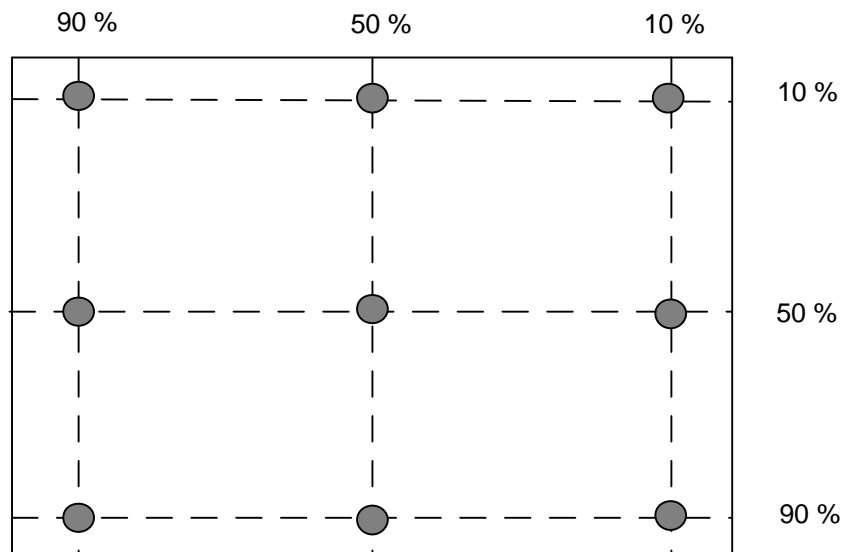

$$\text{Uniformity} = \frac{\text{Minimum Luminance in 9 points (1-9)}}{\text{Maximum Luminance in 9 Points (1-9)}} \times 100\%$$

Note 4: Crosstalk is defined as below :

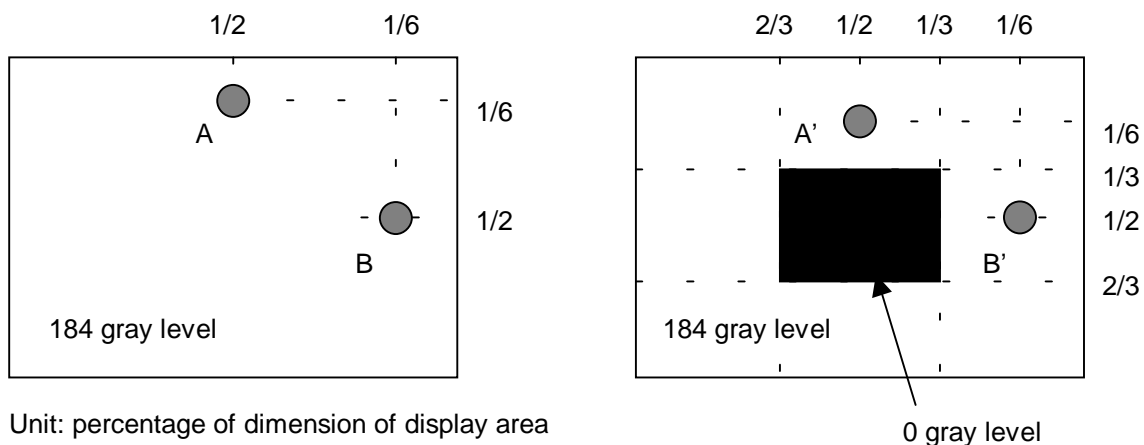

Unit: percentage of dimension of display area

$|L_A - L_{A'}| / L_A \times 100\% = 1.5\% \text{ max.}$, L_A and L_B are brightness at location A and B

$|L_B - L_{B'}| / L_B \times 100\% = 1.5\% \text{ max.}$, $L_{A'}$ and $L_{B'}$ are brightness at location A' and B'

Note5: Test Pattern: Subchecker Pattern

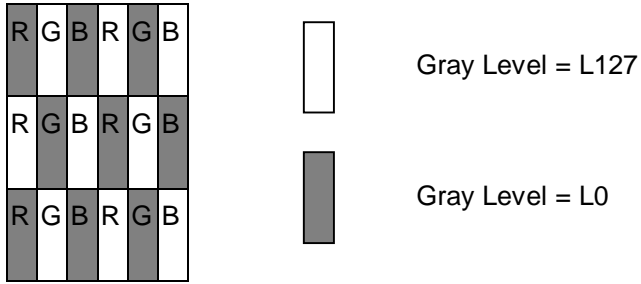

Method: Record dBV & DC value with (WESTAR)TRD-100

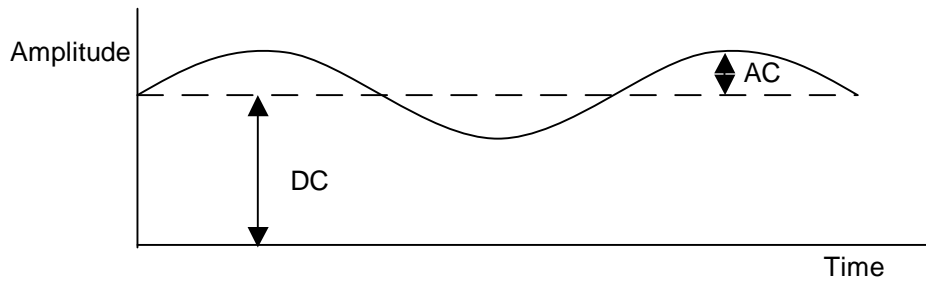

$$\text{Flicker (dB)} = 20 \log \frac{\text{AC Level(at 30 Hz)}}{\text{DC Level}}$$

3.0 Functional Block Diagram

The following diagram shows the functional block of the 20.1 inches wide Color TFT/LCD Module:

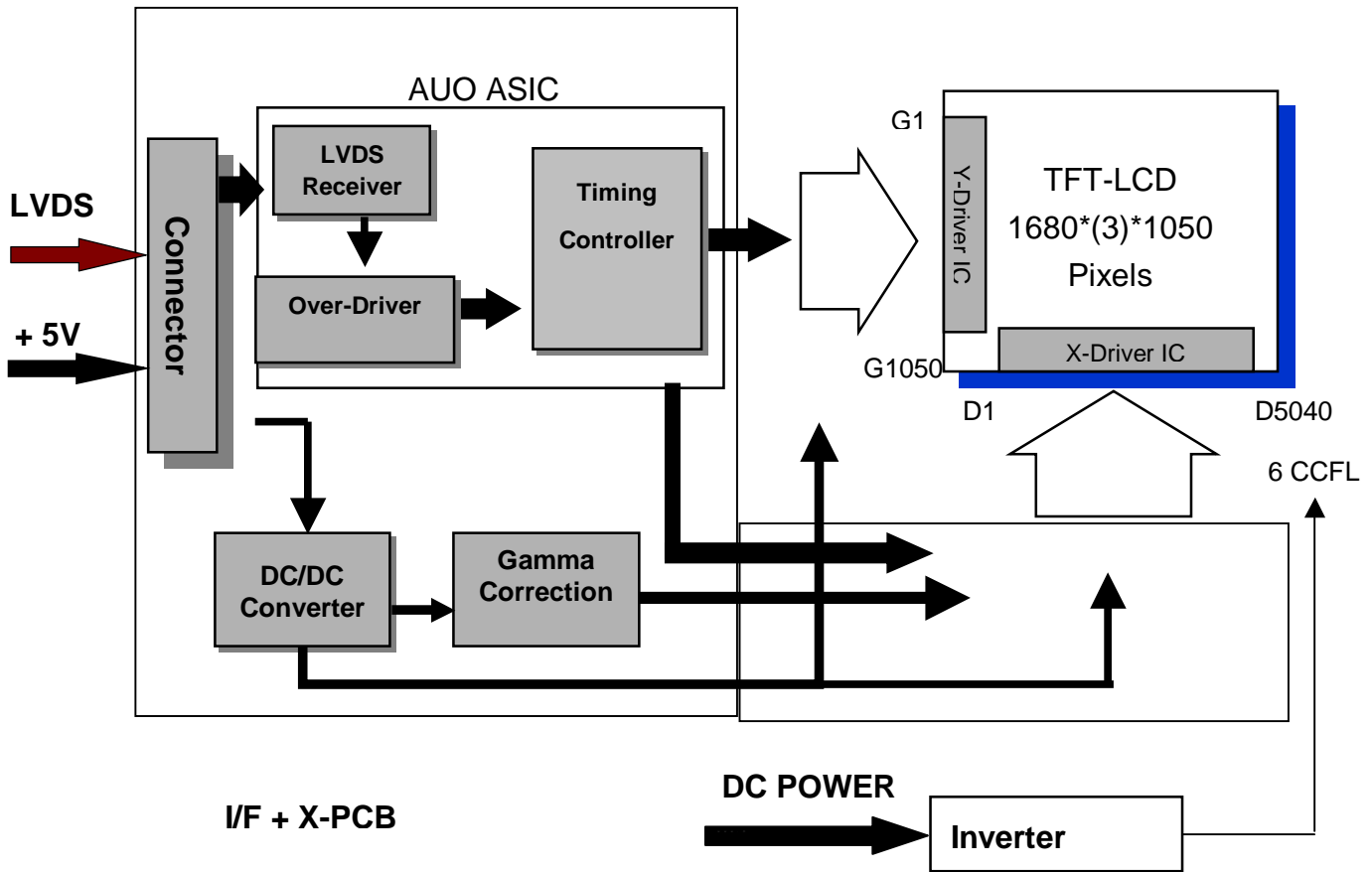

JAE FI-XB30SL-HF10

JST BHSR-02VS-1

Mating Type:

JAE FI-X30HL-T (Locked Type)

JAE FI-X30S-H (Unlocked Type)

Mating Type:

SM02B-BHSS-1-TB

4.0 Absolute Maximum Ratings

Absolute maximum ratings of the module is as following:

4.1 TFT LCD Module

Item	Symbol	Min	Max	Unit	Conditions
Logic/LCD Drive	VIN	-0.3	6	[Volt]	Note 1,2

4.2 Backlight Unit

Item	Symbol	Min	Max	Unit	Conditions
CCFL Current	ICFL	-	8	[mA] rms	Note 1,2

4.3 Absolute Ratings of Environment

Item	Symbol	Min	Max	Unit	Conditions
Operating Humidity	HOP	8	95	[%RH]	Note
Storage Temperature	TST	-20	+60	[°C]	Note
Storage Humidity	HST	8	95	[%RH]	Note

Note 1: With in Ta (25°C)

Note 2: Permanent damage to the device may occur if exceed maximum values

Relative Humidity %

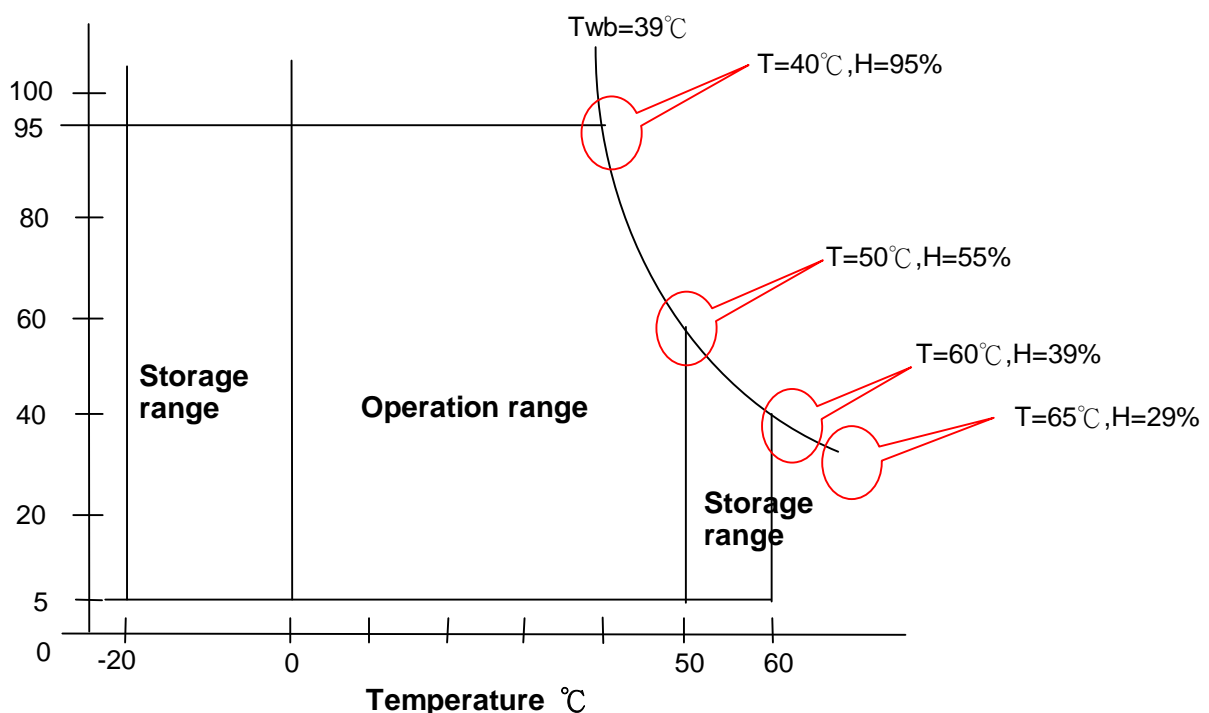

5.0 Electrical characteristics

5.1 TFT LCD Module

5.1.1 Power Specification

Input power specifications are as follows;

Symbol	Parameter	Min	Typ	Max	Units	Condition
VDD	Logic/LCD Drive Voltage	4.5	5	5.5	[Volt]	±10%
IDD	VDD current	-	1300	1400	[mA]	Vin=5V , All White Pattern, at 60Hz
Irush	LCD Inrush Current	-	-	7	[A]	Note
PDD	VDD Power	-	6.5	7	[Watt]	Vin=5V , All White Pattern, at 60Hz
VDDrp	Allowable Logic/LCD Drive Ripple Voltage			100	[mV] p-p	

Note: Measurement conditions:

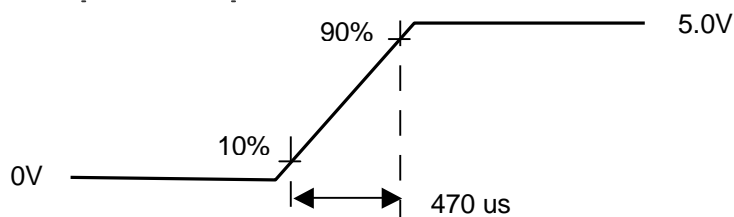
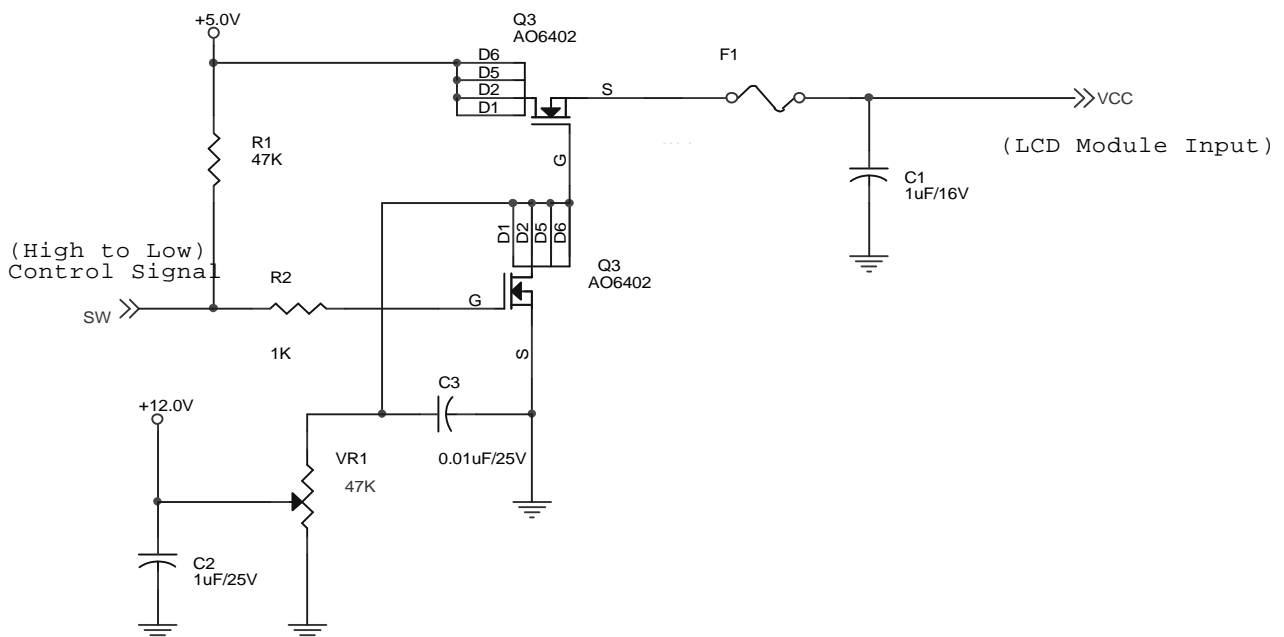

Vin rising time

5.1.2 Signal Electrical Characteristics

Input signals shall be low or Hi-Z state when V_{in} is off

It is recommended to refer the specifications of SN75LVDS82DGG (Texas Instruments) in detail.

Each signal characteristics are as follows;

Symbol	Parameter	Min	Typ	Max	Units	Condition
VTH	Differential Input High Threshold	-	-	+100	[mV]	$V_{ICM} = 1.2V$ Note
VTL	Differential Input Low Threshold	-100	-	-	[mV]	$V_{ICM} = 1.2V$ Note
VID	Input Differential Voltage	100	400	600	[mV]	Note
VICM	Differential Input Common Mode Voltage	+1.0	+1.2	+1.5	[V]	$V_{TH}/V_{TL} = \pm 100MV$ Note

Note: LVDS Signal Waveform

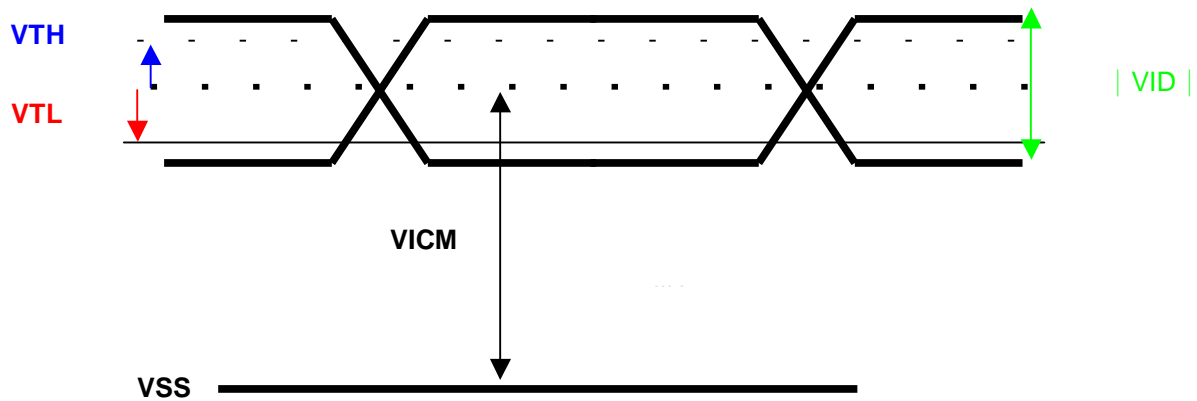

5.2 Backlight Unit

Parameter guideline for CCFL Inverter

Symbol	Parameter	Min.	Typ.	Max.	Unit	Condition
ISCFL	CCFL standard current	5.5	6.0	6.5	[mA] rms	(Ta=25°C) Note 1
IRCFL	CCFL operation range	3.0	6.0	8.0	[mA] rms	(Ta=25°C)
FCFL	CCFL Frequency	40	50	60	[KHz]	(Ta=25°C) Note 2
ViCFL (0°C)	CCFL Ignition Voltage (End of the lamp wire connector)	1950	-		[Volt] rms	(Ta=0°C) Note 3
ViCF (25°C)	CCFL Ignition Voltage (End of the lamp wire connector)	1495	-		[Volt] rms	(Ta=25°C) Note 3
VCFL	CCFL Operation Voltage	740 @8mA	780 @6mA	860 @3mA	[Volt] rms	(Ta=25°C) Note 4
PCFL	CCFL Power consumption (for reference)	-	28	-	[Watt]	(Ta=25°C) Note 5
LTCFL	CCFL life Time	50,000	60,000	-	[Hour]	(Ta=25°C) Note 6

Note 1: CCFL standard current is measured at 25±2°C.

Note 2: CCFL Frequency should be carefully determined to avoid interference between inverter and TFT LCD

Note 3: ViCFL means Ignition Voltage for both ends of the lamp, and CCFL inverter should be able to give out a power that has a generating capacity of over ViCFL for ignition

Note 4: CCFL operation voltage is measured at 25±2°C.

Note 5: The variance of CCFL power consumption is ±10%. Power is calculated for reference

(ICFL×VCFL×6=PCFL).

Note 6: Definition of life: brightness becomes 50% or less than the minimum luminance value of CCFL..The typical life time of CCFL is on the condition at 6.0 mA lamp current.

6.0 Signal Characteristic

6.1 Pixel Format Image

Following figure shows the relationship of the input signals and LCD pixel format.

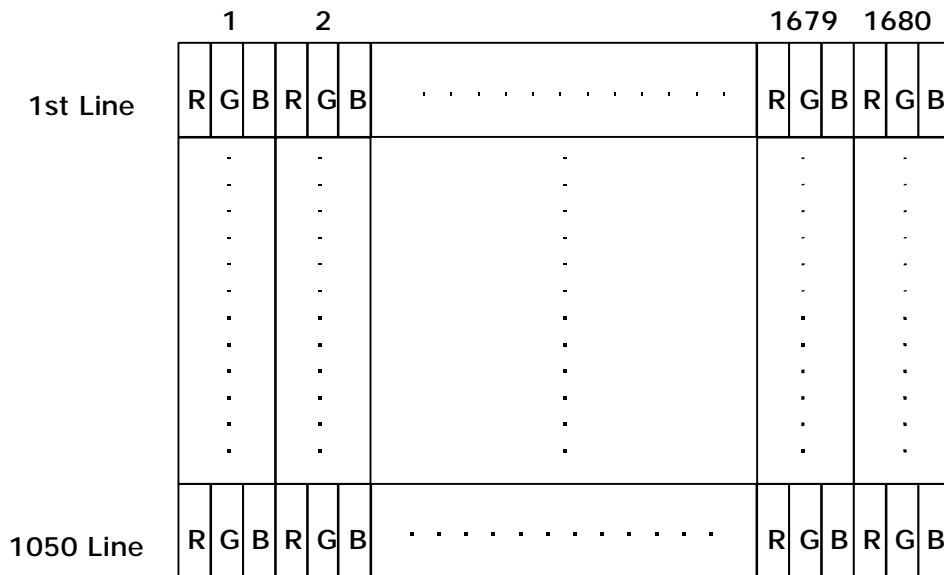

6.2 The input data format

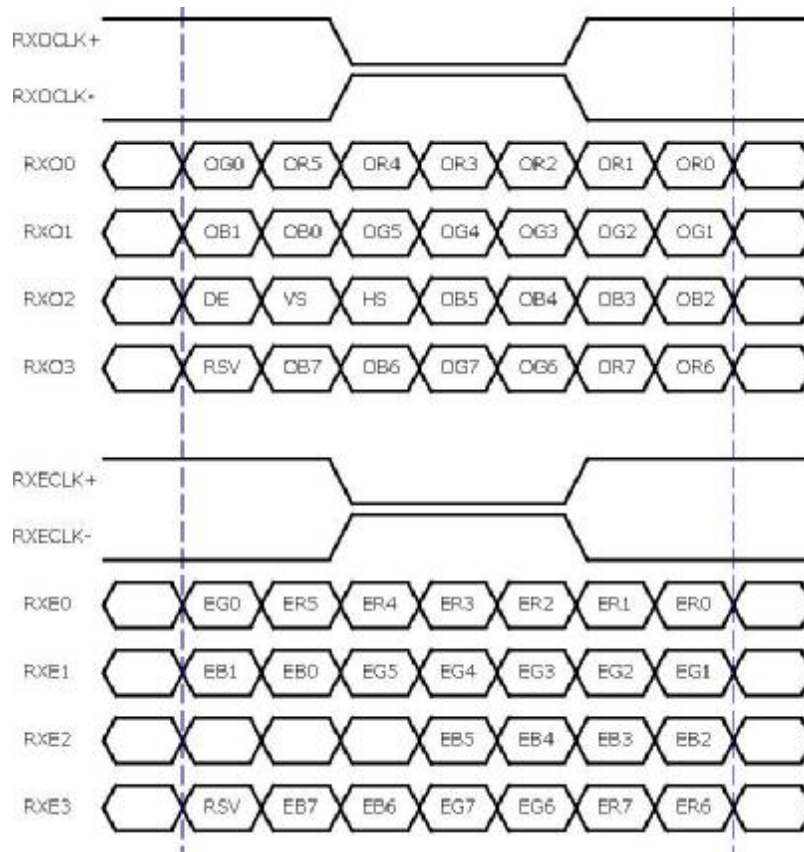

Note 1: R/G/B data 7:MSB, R/G/B data 0:LSB
 O = "First Pixel Data"
 E = "Second Pixel Data"

6.3 Signal Description

The module using one LVDS receiver SN75LVDS82(Texas Instruments) or compatible. LVDS is a differential signal technology for LCD interface and high speed data transfer device. Transmitter shall be SN75LVDS83(negative edge sampling) or compatible. The first LVDS port(RxOxxx) transmits odd pixels while the second LVDS port(RxExxx) transmits even pixels.

PIN #	SIGNAL NAME	DESCRIPTION
1	RxO0-	Negative LVDS differential data input (Odd data)
2	RxO0+	Positive LVDS differential data input (Odd data)
3	RxO1-	Negative LVDS differential data input (Odd data)
4	RxO1+	Positive LVDS differential data input (Odd data)
5	RxO2-	Negative LVDS differential data input (Odd data, H-Sync,V-Sync,DSPTMG)
6	RxO2+	Positive LVDS differential data input (Odd data, H-Sync,V-Sync,DSPTMG)
7	GND	Power Ground
8	RxOC-	Negative LVDS differential clock input (Odd clock)
9	RxOC+	Positive LVDS differential clock input (Odd clock)
10	RxO3-	Negative LVDS differential data input (Odd data)
11	RxO3+	Positive LVDS differential data input (Odd data)
12	RxE0-	Negative LVDS differential data input (Even clock)
13	RxE0+	Positive LVDS differential data input (Even data)
14	GND	Power Ground
15	RxE1-	Positive LVDS differential data input (Even data)
16	RxE1+	Negative LVDS differential data input (Even data)
17	GND	Power Ground
18	RxE2-	Negative LVDS differential data input (Even data)
19	RxE2+	Positive LVDS differential data input (Even data)
20	RxEC-	Negative LVDS differential clock input (Even clock)
21	RxEC+	Positive LVDS differential clock input (Even clock)
22	RxE3-	Negative LVDS differential data input (Even data)
23	RxE3+	Positive LVDS differential data input (Even data)
24	GND	Power Ground
25	NC	No contact (For AUO test only)
26	NC	No contact (For AUO test only)
27	NC	No contact (For AUO test only)
28	POWER	Power
29	POWER	Power
30	POWER	Power

Note1: Start from left side

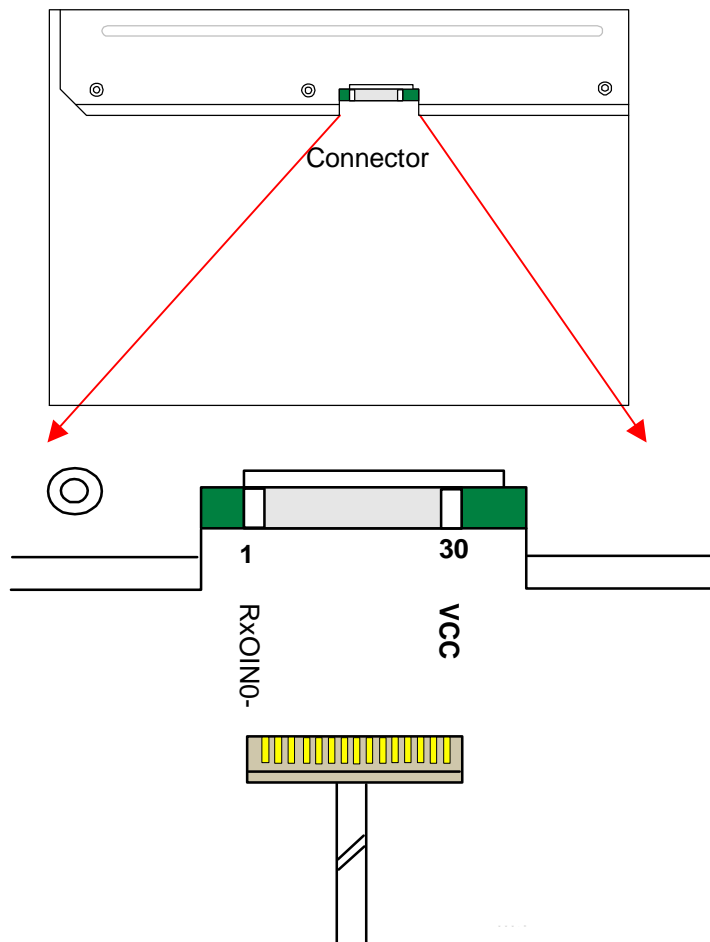

Note2: Input signals of odd and even clock shall be the same timing.

6.4 Timing Characteristics

Basically, interface timings described here is not actual input timing of LCD module but output timing of SN75LVDS82DGG (Texas Instruments) or equivalent.

Signal	Item	Symbol	Min	Typ	Max	Unit
Vertical Section	Period	T_v	1061	1087	1600	Th
	Active	$T_{disp(v)}$	1050	1050	1050	Th
	Blanking	$T_{bp(v)}+T_{fp(v)}+PW_{vs}$	11	37	550	Th
Horizontal Section	Period	T_h	920	1128	1400	Tclk
	Active	$T_{disp(h)}$	840	840	840	Tclk
	Blanking	$T_{bp(h)}+T_{fp(h)}+PW_{hs}$	80	288	560	Tclk
Clock	Period	Tclk	12.3	13.6	16.67	ns
	Frequency	Freq	60	73.5	81	MHz
Frame rate	Frame rate	F	60	60	75	Hz

Note : DE mode only

6.4.1 Timing diagram

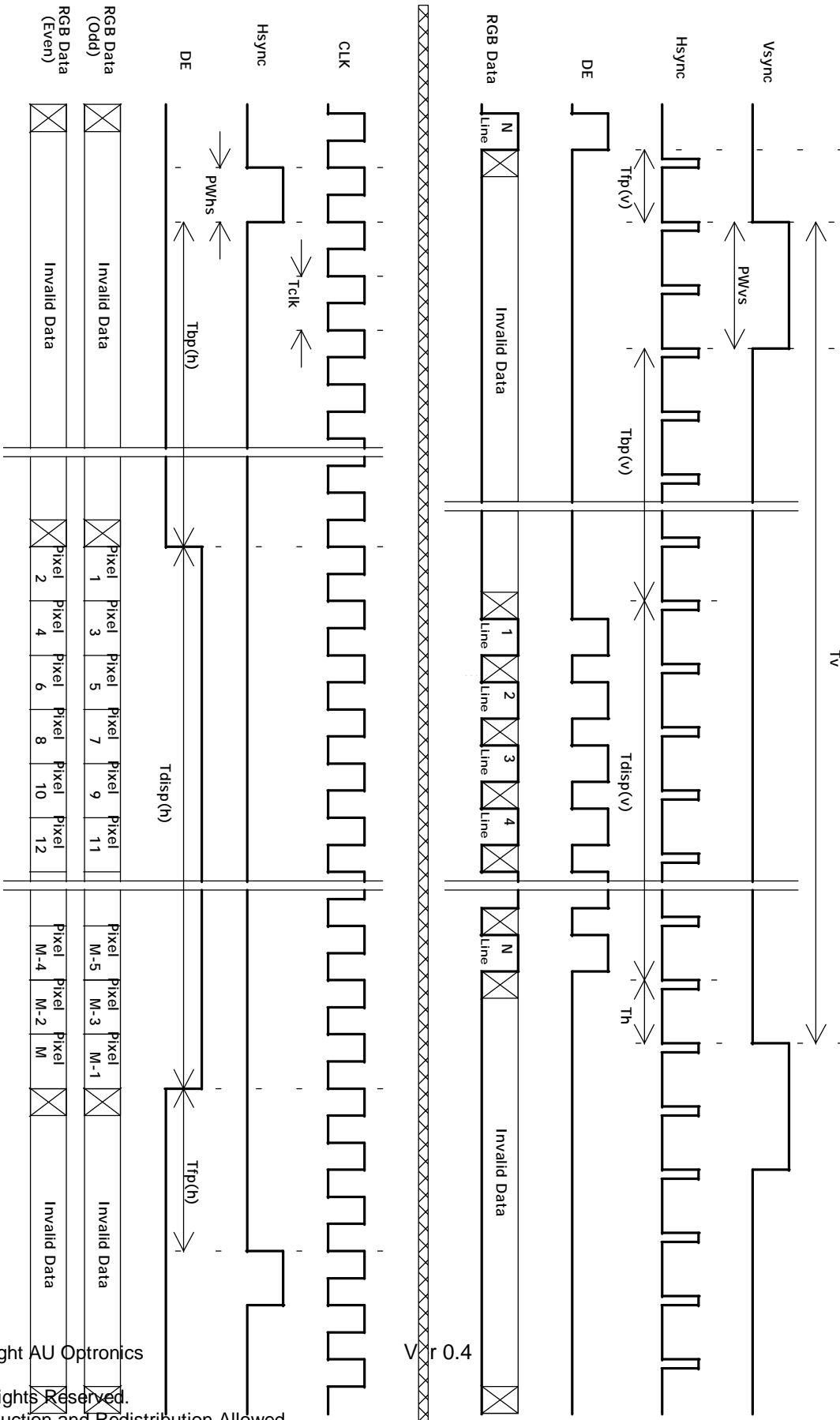

6.5 Power ON/OFF Sequence

Vin power and lamp on/off sequence is as follows. Interface signals are also shown in the chart. Signals from any system shall be Hi-Z state or low level when Vin is off.

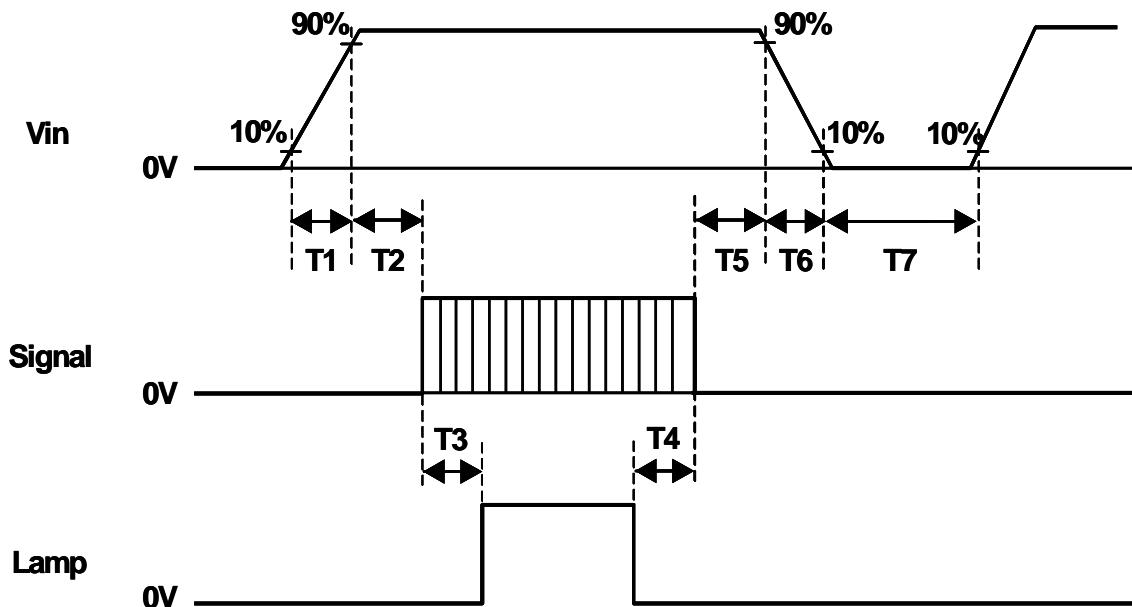

Symbol	Values			Unit
	Min	Typ	Max	
T1	0.5	-	10	[ms]
T2	0.5	40	50	[ms]
T3	200	-	-	[ms]
T4	200	-	-	[ms]
T5	0.5	16	50	[ms]
T6	-	-	10	[ms]
T7	1000	-	-	[ms]

7.0 Connector & Pin Assignment

Physical interface is described as for the connector on module.

These connectors are capable of accommodating the following signals and will be following components.

7.1 TFT LCD Module

Connector Name / Designation	Interface Connector / Interface card
Manufacturer	JAE or compatible
Type Part Number	FI-XB30SL-HF10
Mating Housing Part Number	FI-X30HL-T (Locked Type) FI-X30S-H (Unlocked Type)

Pin#	Signal Name	Pin#	Signal Name
1	RxO0-	2	RxO0+
3	RxO1-	4	RxO1+
5	RxO2-	6	RxO2+
7	GND	8	RxOC-
9	RxOC+	10	RxO3-
11	RxO3+	12	RxE0-
13	RxE0+	14	GND
15	RxE1-	16	RxE1+
17	GND	18	RxE2-
19	RxE2+	20	RxEC-
21	RxEC+	22	RxE3-
23	RxE3+	24	GND
25	NC	26	NC
27	NC	28	Power
29	Power	30	Power

7.2 Backlight Unit

Connector Name / Designation	Lamp Connector / Backlight lamp
Manufacturer	JST
Type Part Number	BHSR-02VS-1 (CN3/CN4) BHR-05VS-1 (CN2/CN5)
Mating Type Part Number	SM02B-BHSS-1-TB (2pin) SM04 (9-E2) B-BHS-1-TB (5pin)

7.3 Signal for Lamp connector

	Connector No.	Pin No.	Color	Function
Upper	CN2	1	Pink	High Voltage (Lamp 1)
		2	Sky Blue	High Voltage (Lamp 2)
		3	NC	NC
		4	Black	Low Voltage (Lamp 1)
		5	Dark Blue	Low Voltage (Lamp 2)
	CN3	1	White	High Voltage (Lamp 3)
		2	White	Low Voltage (Lamp 3)
Lower	CN4	1	White	High Voltage (Lamp 4)
		2	White	Low Voltage (Lamp 4)
	CN5	1	Pink	High Voltage (Lamp 6)
		2	Sky Blue	High Voltage (Lamp 5)
		3	NC	NC
		4	Black	Low Voltage (Lamp 6)
		5	Dark Blue	Low Voltage (Lamp 5)

Upper

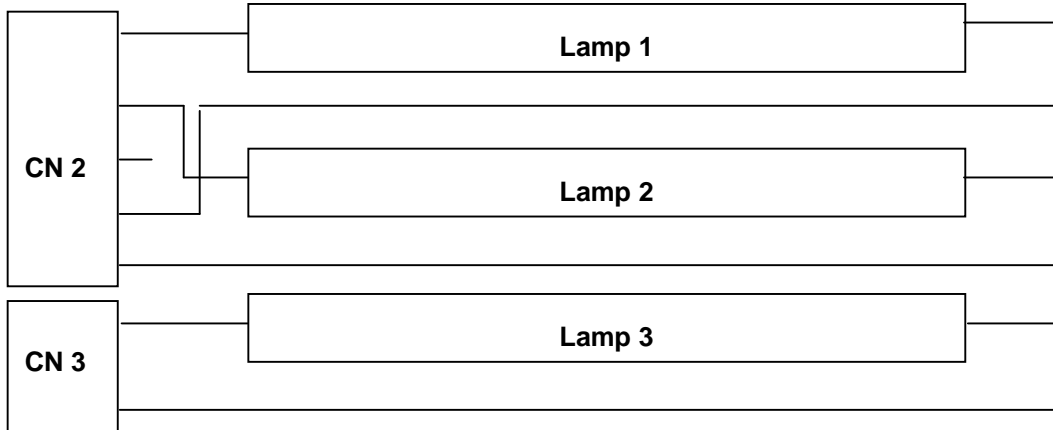

Lower

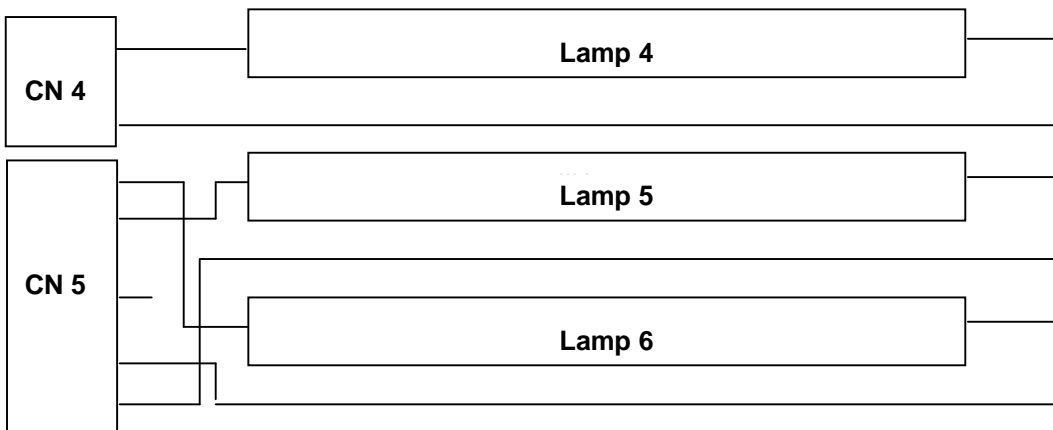

8.0 Reliability

Reliability test condition

No	Test Item	Test Condition
1	Temperature Humidity Bias (THB)	50°C, 80%, 300hours
2	High Temperature Operation (HTO)	50°C, 300hours
3	Low Temperature Operation (LTO)	0°C, 300hours
4	High Temperature Storage (HTS)	60°C, 300hours
5	Low Temperature Storage (LTS)	-20°C, 300hours
6	Thermal Shock Test (TST)	-20°C/30min, 60°C/30min, 100 cycles
7	On/Off Test	On/10sec, Off/10sec, 30,000 cycles
8	Shock Test (Non-Operating)	50G, 20ms, Half-sine wave (+ X, ±Y, ±Z)
9	Vibration Test (Non-Operating)	1.5G(10~200Hz P- P), 30 Minutes each Axis (X, Y, Z)
10	Drop test	Package test: The drop height is 60cm.
11	ESD (ElectroStatic Discharge)	Contact Discharge: ± 8KV, 150pF(330Ω) 1sec, 8 points, 25 times/ point Air Discharge: ± 15KV, 150pF(330Ω) 1sec, 8 points, 25 times/ point
12	Altitude Test	Operation:10,000 ft Non-Operation:30,000 ft

9.0 Environment

The display module will meet the provision of this specification during operating condition or after storage or shipment condition specified below. Operation at 10% beyond the specified range will not cause physical damage to the unit.

9.1 Temperature and Humidity

9.1.1 Operating Conditions

The display module operates error free, when operated under the following conditions;

Temperature	0 °C to 50 °C
Relative Humidity	8% to 95%
Wet Bulb Temperature	39.0 °C

9.1.2 Shipping Conditions

The display module operates error free, after the following conditions;

Temperature	-20 °C to 60 °C
Relative Humidity	8% to 95%
Wet Bulb Temperature	39.0 °C

9.2 Atmospheric Pressure

The display assembly is capable of being operated without affecting its operations over the pressure range as following specified;

	Pressure	Note
Maximum Pressure	1040hPa	0m = sea level
Minimum Pressure	674hPa	3048m = 10.000 feet

Note : Non-operation attitude limit of this display module = 30,000 feet. = 9145 m.

10.0 Safety

10.1 Sharp Edge Requirements

There will be no sharp edges or corners on the display assembly that could cause injury.

10.2 Materials

10.2.1 Toxicity

There will be no carcinogenic materials used anywhere in the display module. If toxic materials are used, they will be reviewed and approved by the responsible ADT Toxicologist.

10.2.2 Flammability

All components including electrical components that do not meet the flammability grade UL94-V1 in the module will complete the flammability rating exception approval process.

The printed circuit board will be made from material rated 94-V1 or better. The actual UL flammability rating will be printed on the printed circuit board.

10.3 Capacitors

If any polarized capacitors are used in the display assembly, provisions will be made to keep them from being inserted backwards.

11.0 Other requirement

11.1 National Test Lab Requirement

The display module will satisfy all requirements for compliance to

UL 1950, First Edition
CSA C22.2 No.950-M89
EEC 950
EN 60 950

U.S.A. Information Technology Equipment
Canada, Information Technology Equipment
International, Information Technology Equipment
International, Information Processing Equipment
(European Norm for IEC950)

11.2 Label

The label is on the panel as shown below:

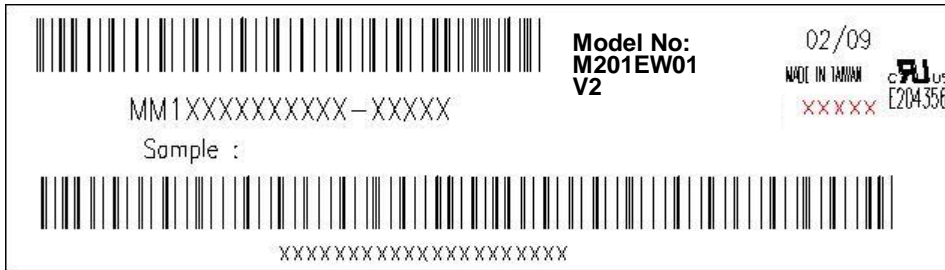

12.0 Mechanical Characteristics

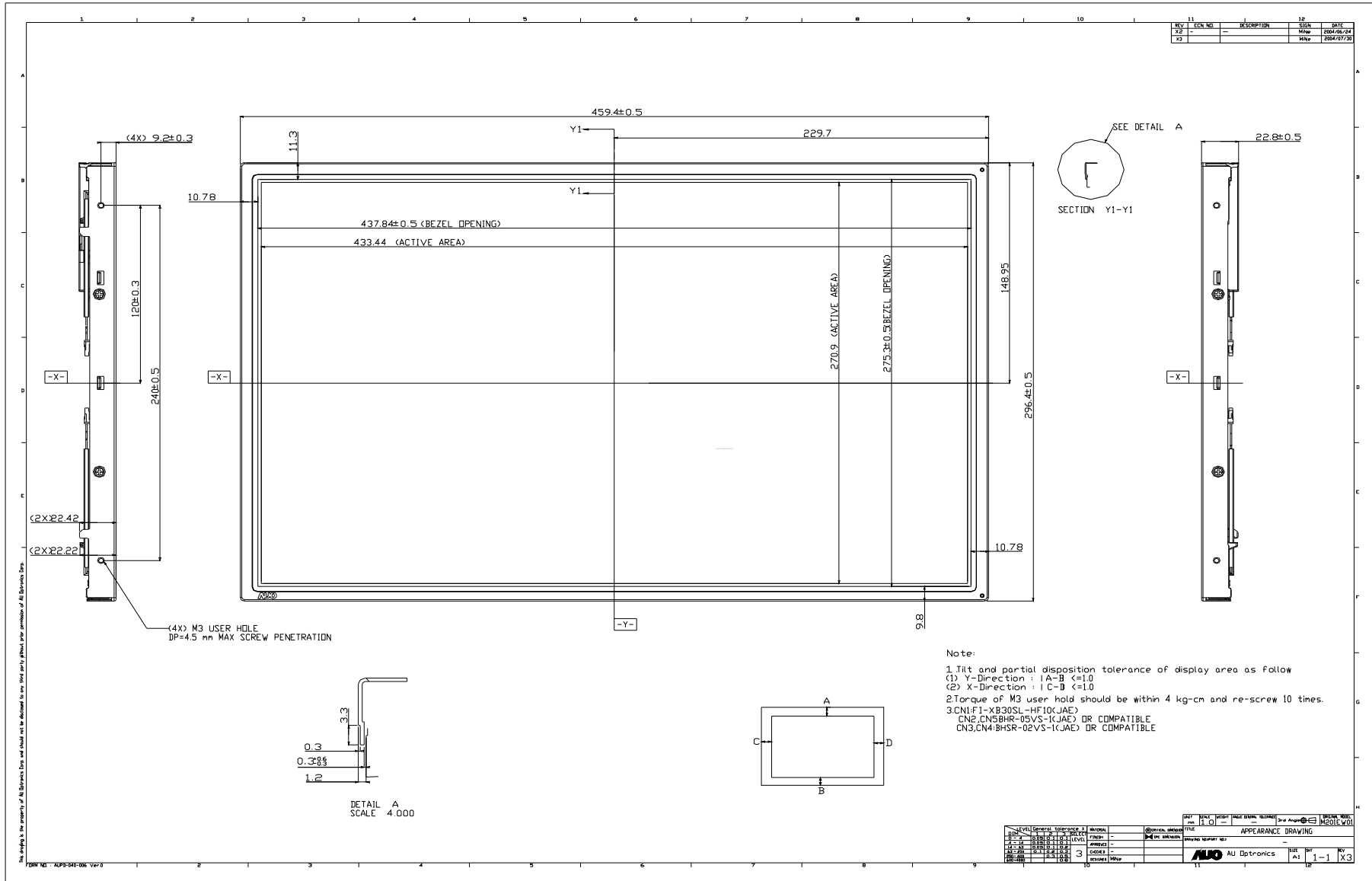

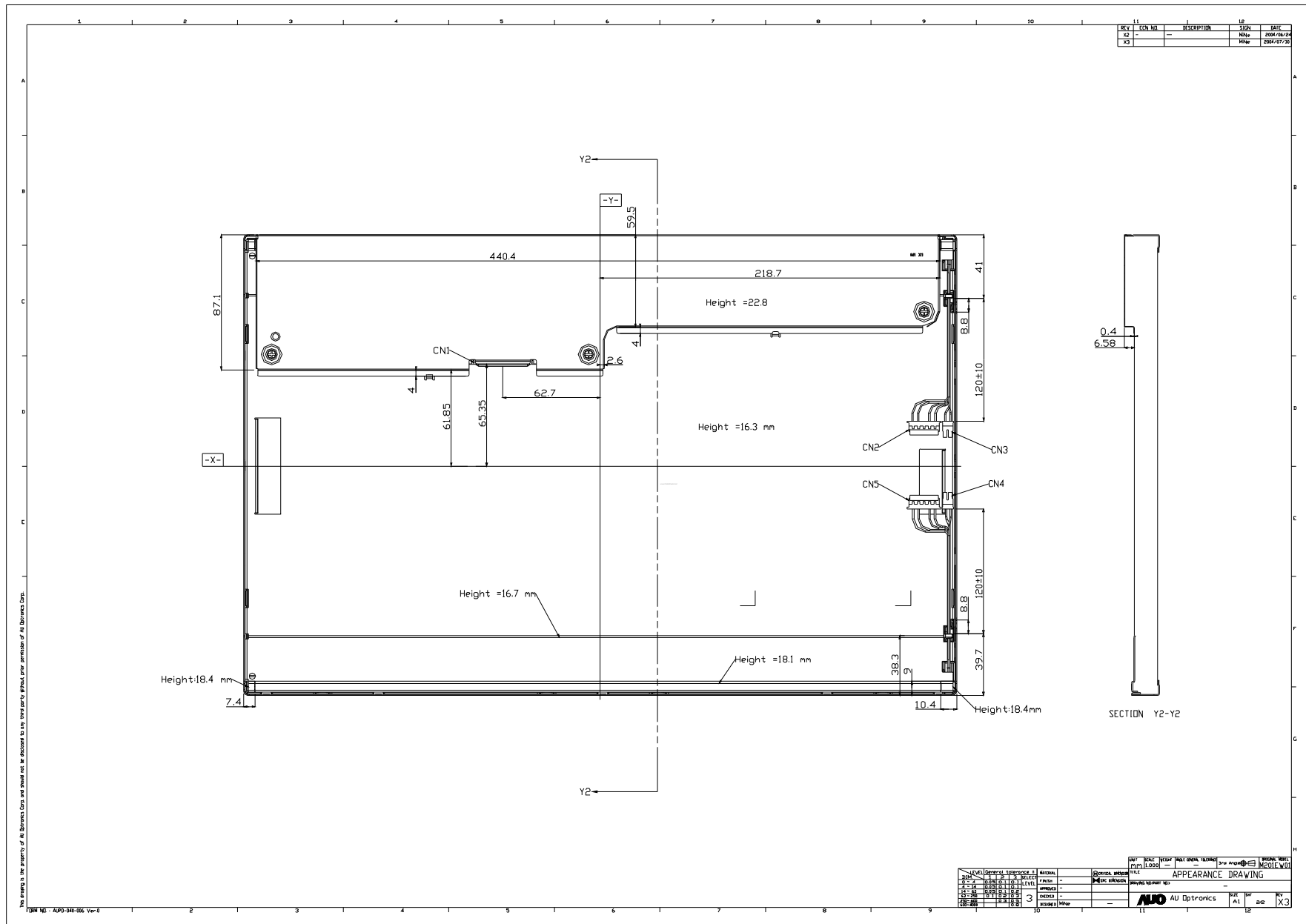

Ver0.4

32/32