

High-Voltage Trench MOS Barrier Schottky Rectifier

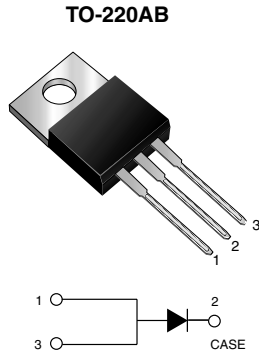

FEATURES

- Guardring for overvoltage protection
- Lower power losses, high efficiency
- Low forward voltage drop
- High forward surge capability
- High frequency operation
- Solder Dip 260 °C, 40 seconds
- Component in accordance to RoHS 2002/95/EC and WEEE 2002/96/EC



TYPICAL APPLICATIONS

For use in low voltage, high frequency rectifier of switching mode power supplies, free-wheeling diodes, dc-to-dc converters or polarity protection applications.

MECHANICAL DATA

Case: TO-220AB

Epoxy meets UL 94V-0 flammability rating

Terminals: Matte tin plated leads, solderable per J-STD-002B and JESD22-B102D

E3 suffix for commercial grade

Polarity: As marked

Mounting Torque: 10 in-lbs maximum

MAJOR RATINGS AND CHARACTERISTICS

$I_{F(AV)}$	20 A
V_{RRM}	35 V, 45 V
I_{FSM}	200 A
V_F at $I_F = 20$ A	0.55 V
T_j max.	150 °C

MAXIMUM RATINGS ($T_A = 25$ °C unless otherwise noted)

PARAMETER	SYMBOL	M2035S	M2045S	UNIT
Maximum repetitive peak reverse voltage	V_{RRM}	35	45	V
Maximum average forward rectified current (see Fig. 1)	$I_{F(AV)}$	20		A
Peak forward surge current 8.3 ms single half sine-wave superimposed on rated load	I_{FSM}	200		A
Peak repetitive reverse current per leg at $t_p = 2$ μ s, 1 kHz	I_{RRM}	2.0		A
Voltage rate of change (rated V_R)	dv/dt	10000		V/ μ s
Operating junction and storage temperature range	T_J, T_{STG}	- 55 to + 150		°C



ELECTRICAL CHARACTERISTICS (T _A = 25 °C unless otherwise noted)						
PARAMETER	TEST CONDITIONS		SYMBOL	TYP.	MAX.	UNIT
Instantaneous forward voltage ⁽¹⁾	at I _F = 10 A	T _J = 25 °C	V _F	0.52	-	V
	at I _F = 20 A			0.62	0.70	
	at I _F = 10 A	T _J = 125 °C		0.42	-	
	at I _F = 20 A			0.55	0.61	
Maximum reverse current at rated V _R ⁽¹⁾	T _J = 25 °C T _J = 125 °C		I _R	80 24	200 35	μA mA
Typical junction capacitance	at 4.0 V, 1 MHz		C _J	700		pF

Note:

(1) Pulse test: 300 μs pulse width, 1 % duty cycle

THERMAL CHARACTERISTICS (T _A = 25 °C unless otherwise noted)				
PARAMETER	SYMBOL	M2035S	M2045S	UNIT
Typical thermal resistance	R _{θJC}	2.0		°C/W

ORDERING INFORMATION				
PREFERRED P/N	UNIT WEIGHT (G)	PREFERRED PACKAGE CODE	BASE QUANTITY	DELIVERY MODE
M2045S-E3/4W	1.877	4W	50/Tube	Tube

RATINGS AND CHARACTERISTICS CURVES

(T_A = 25 °C unless otherwise noted)

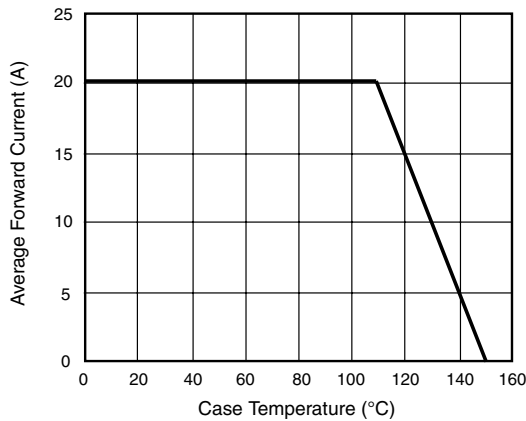

Figure 1. Forward Current Derating Curve

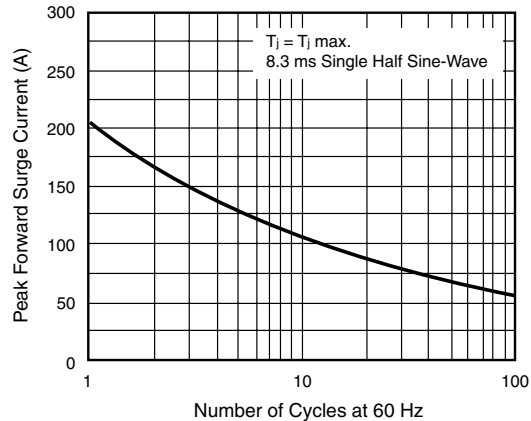

Figure 2. Maximum Non-Repetitive Peak Forward Surge Current

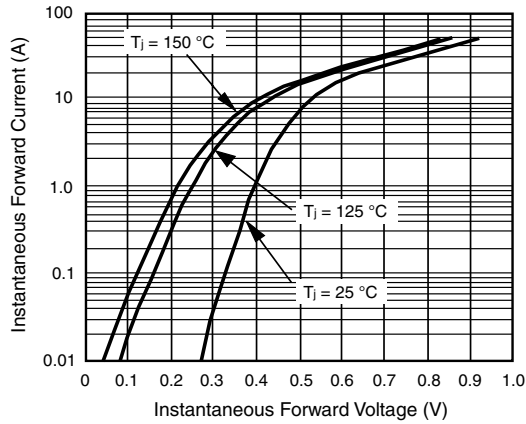

Figure 3. Typical Instantaneous Forward Characteristics

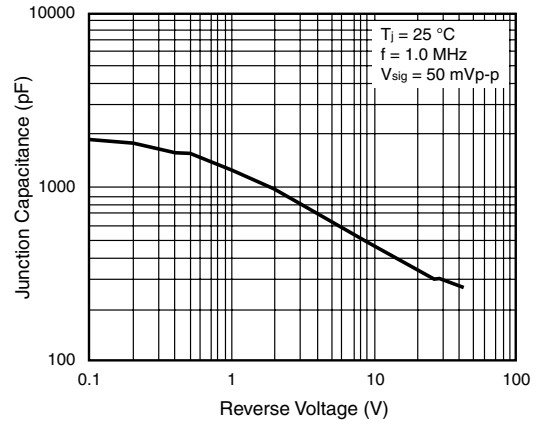

Figure 5. Typical Junction Capacitance

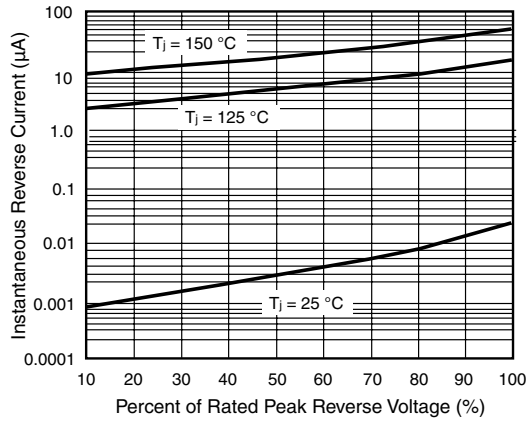
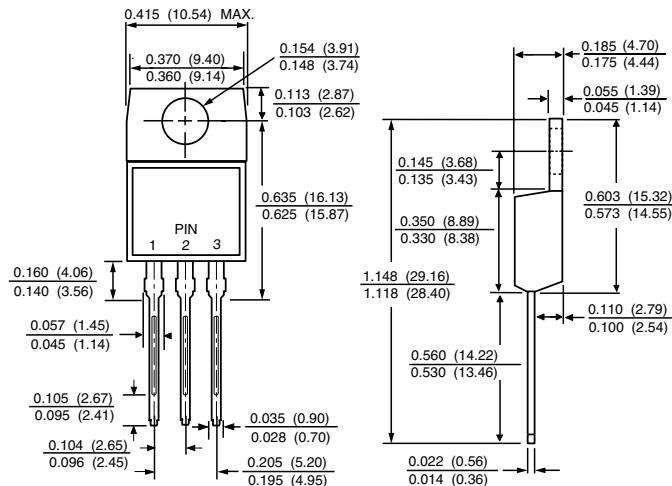

Figure 4. Typical Reverse Characteristics

PACKAGE OUTLINE DIMENSIONS in inches (millimeters)

TO-220AB





Notice

Specifications of the products displayed herein are subject to change without notice. Vishay Intertechnology, Inc., or anyone on its behalf, assumes no responsibility or liability for any errors or inaccuracies.

Information contained herein is intended to provide a product description only. No license, express or implied, by estoppel or otherwise, to any intellectual property rights is granted by this document. Except as provided in Vishay's terms and conditions of sale for such products, Vishay assumes no liability whatsoever, and disclaims any express or implied warranty, relating to sale and/or use of Vishay products including liability or warranties relating to fitness for a particular purpose, merchantability, or infringement of any patent, copyright, or other intellectual property right.

The products shown herein are not designed for use in medical, life-saving, or life-sustaining applications. Customers using or selling these products for use in such applications do so at their own risk and agree to fully indemnify Vishay for any damages resulting from such improper use or sale.