

# AU OPTRONICS CORPORATION

## Product Specification

### 23.0” Wide-UXGA Color TFT-LCD Module

**Model Name: M230UW01 V.0**

Approved by	Prepared by
<i>CC Chiu</i>	<i>GaryChen</i>

*DDBU Marketing Division / AU Optronics corporation*

Customer	Checked & Approved by

## Product Specification

### **23.0” Wide-UXGA Color TFT-LCD Module** **Model Name: M230UW01** **V.0**

Preliminary Specifications  
 Final Specifications

**Note: This Specification is subject to change without notice.**

## Contents

<b>1.0 Handling Precautions</b> .....	<b>5</b>
<b>2.0 General Description</b> .....	<b>6</b>
2.1 Display Characteristics.....	6
2.2 Optical Characteristics .....	7
<b>3.0 Functional Block Diagram</b> .....	<b>10</b>
<b>4.0 Absolute Maximum Ratings</b> .....	<b>11</b>
4.1 TFT LCD Module .....	11
4.2 Backlight Unit .....	11
4.3 Absolute Ratings of Environment (TETANTIVE) .....	11
<b>5.0 Electrical characteristics</b> .....	<b>12</b>
5.1 TFT LCD Module .....	12
5.1.1 Power Specification.....	12
5.1.2 Signal Electrical Characteristics.....	13
5.2 Backlight Unit .....	14
<b>6.0 Signal Characteristic</b> .....	<b>15</b>
6.1 Pixel Format Image .....	15
6.2 The input data format .....	15
6.3 Signal Description .....	16
6.4 Interface Timing.....	17
6.4.1 Timing Characteristics.....	17
6.4.2 Timing diagram .....	18
6.5 Power ON/OFF Sequence.....	19
<b>7.0 Connector &amp; Pin Assignment</b> .....	<b>20</b>
7.1 TFT LCD Module .....	20
7.2 Backlight Unit .....	20
7.3 Signal for LED Driver connector.....	21
<b>8.0 Reliability</b> .....	<b>22</b>
<b>9.0 Safety</b> .....	<b>23</b>
9.1 Sharp Edge Requirements .....	23
9.2 Materials.....	23
9.2.1 Toxicity .....	23
9.2.2 Flammability .....	23
9.3 Capacitors .....	23
<b>10.0 Other requirement</b> .....	<b>23</b>
10.1 National Test Lab Requirement .....	23
10.2 Label .....	23
<b>13.0 Mechanical Characteristics</b> .....	<b>24</b>

## Record of Revision

Version and Date	Page	Old description	New Description	Remark
0.1 2004/12/03	All	First Edition for Customer	All	

## 1.0 Handling Precautions

- 1) Since front polarizer is easily damaged, pay attention not to scratch it.
- 2) Be sure to turn off power supply when inserting or disconnecting from input connector.
- 3) Wipe off water drop immediately. Long contact with water may cause discoloration or spots.
- 4) When the panel surface is soiled, wipe it with absorbent cotton or other soft cloth.
- 5) Since the panel is made of glass, it may break or crack if dropped or bumped on hard surface.
- 6) Since CMOS LSI is used in this module, take care of static electricity and insure human earth when handling.
- 7) Do not open nor modify the Module Assembly.
- 8) Do not press the reflector sheet at the back of the module to any directions.
- 9) In case if a module has to be put back into the packing container slot after once it was taken out from the container, do not press the center of the LED reflector edge. Instead, press at the far ends of the LED reflector edge softly. Otherwise the TFT module may be damaged.
- 10) At the insertion or removal of the Signal Interface Connector, be sure not to rotate nor tilt the Interface Connector of the TFT module.
- 11) After installation of the TFT module into an enclosure (Desktop monitor Bezel, for example), do not twist nor bend the TFT Module even momentary. At designing the enclosure, it should be taken into consideration that no bending/twisting forces are applied to the TFT module from outside. Otherwise the TFT module may be damaged.

## 2.0 General Description

This specification applies to the 23.0 inch Color TFT-LCD Module M230UW01.

The display supports the Wide-UXGA (1920(H) x 1200(V)) screen format and 16.7M colors (RGB 8-bits data).

All input signals are 2 Channel LVDS interface compatible.

This module contains two LED driver cards for backlight.

## 2.1 Display Characteristics

The following items are characteristics summary on the table under 25 °C condition:

ITEMS	Unit	SPECIFICATIONS			
Screen Diagonal	[mm]	584.15 (23")			
Active Area	[mm]	495.36 (H) x 309.6 (V)			
Pixels H x V		1920(x3) x 1200			
Pixel Pitch	[mm]	0.258 (per one triad) x 0.258			
Pixel Arrangement		R.G.B. Vertical Stripe			
Display Mode		Normally Black			
White Luminance ( Center )	[cd/m <sup>2</sup> ]	200 (Typ, Center at R: 350mA ; G,B: 480mA )			
Contrast Ratio		700 : 1 (Typ)			
Optical Response Time (Gray to Gray)	[msec]	8 ms (Typ, average)			
Nominal Input Voltage VDD	[Volt]	+12.0 V			
Power Consumption (VDD line + LED B/L )	[Watt]	135W (Typ) (With LED Driver, All white pattern)			
Weight	[Grams]	6500 (Max)			
Physical Size	[mm]		Min.	Typ.	Max.
		Horizatal(H)	637.5	638.3	639.1
		Vertical(V)	388.1	388.9	389.7
		Depth(D)	60.9	61.5	62.1
Electrical Interface		2 Channel LVDS			
Support Color		16.7M colors (RGB 8-bit data )			
Surface Treatment		Glare type, Hard Coating (2H)			
Temperature Range					
Operating	[°C]	0 to +40			
Storage (Shipping)	[°C]	-20 to +60			

## 2.2 Optical Characteristics

The optical characteristics are measured under stable conditions at 25°C and after lighting the B/L 30~40 minutes:

Item	Unit	Conditions	Min.	Typ.	Max.	Note
Viewing Angle	[degree]	Horizontal (Right)	75	85	-	
		CR = 10 (Left)	75	85	-	
	[degree]	Vertical (Up)	75	85	-	
		CR = 10 (Down)	75	85	-	
Contrast ratio		Normal Direction	400	700	-	
Response Time	[msec]	Gray to Gray (average)	-	8	12	<b>Note 1</b>
Color / Chromaticity Coordinates (CIE)		Red x	0.660	0.690	0.720	
		Red y	0.270	0.300	0.330	
		Green x	0.183	0.213	0.243	
		Green y	0.656	0.686	0.716	
		Blue x	0.114	0.144	0.174	
		Blue y	0.066	0.096	0.126	
Color Coordinates (CIE) White		White x	0.283	0.313	0.343	
		White y	0.299	0.329	0.359	
White Luminance at LED driving current R:350.0mA;G,B:480mA (central point)	[cd/m <sup>2</sup> ]		150	200	-	
Luminance Uniformity	[%]		75	80	-	<b>Note 2</b>
Crosstalk (in 60Hz)	[%]				1.5	<b>Note 3</b>
Flicker	dB				-20	<b>Note 4</b>

Equipment Pattern Generator, Power Supply, Digital Voltmeter, Luminance meter (PR 880, BM-5A , BM 7 ,CS-1000, & EZContrast\* )

Aperture 1° with 100cm VD or 2° with 50cm viewing distance

Test Point Center (VESA point 9)

Environment < 1 lux

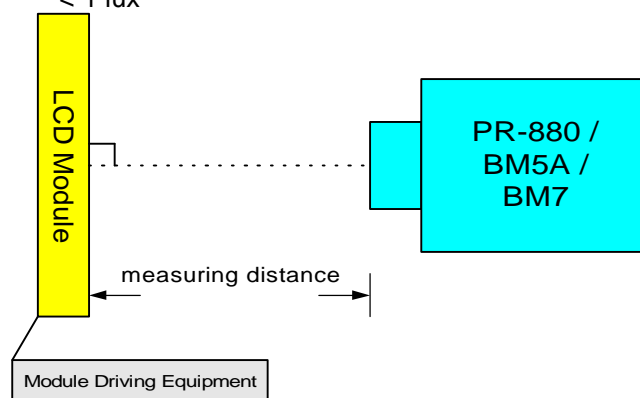

\*' EZ Contrast is different measurement tool with very close viewing distance.

**Note 1: The Definition of Response time**

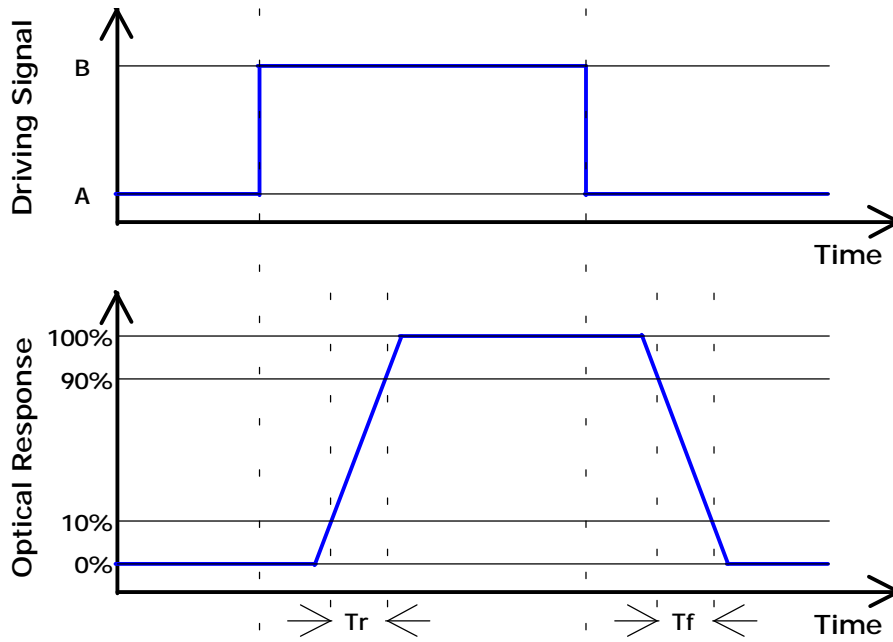

Algorithm:

$| \text{Level A} - \text{Level B} | \geq 16$  then the average of Gray-to-Gray response time is 8ms(Typ). At frame rate= 60 Hz condition.

$T_{rR}$ (On/Off rising time; from “Black” to “White”) +  $T_{rF}$ (On/Off falling time; from “White” to “Black”) = 15 + 5= 20ms(Typ).

**Note 2: Brightness uniformity of these 9 points is defined as below**

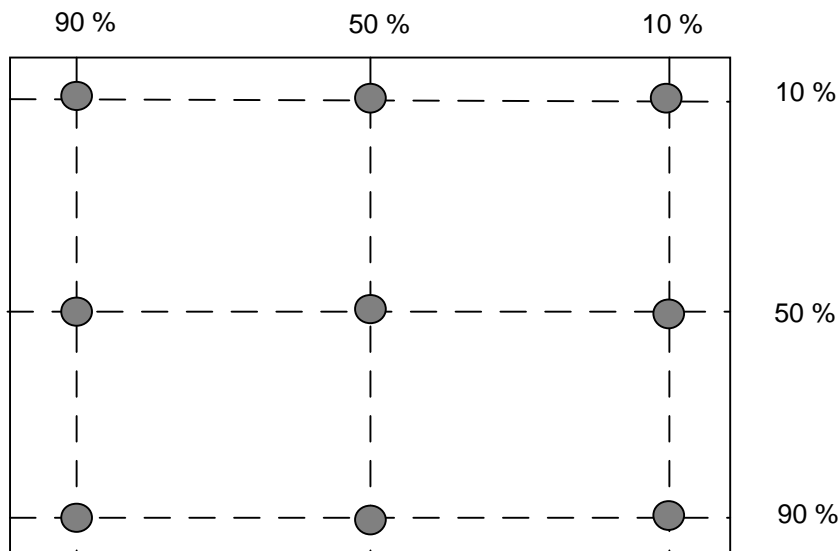

$$\text{Uniformity} = \frac{\text{Minimum Luminance in 9 points (1-9)}}{\text{Maximum Luminance in 9 Points (1-9)}}$$



**Note 3: Crosstalk is defined as below:**

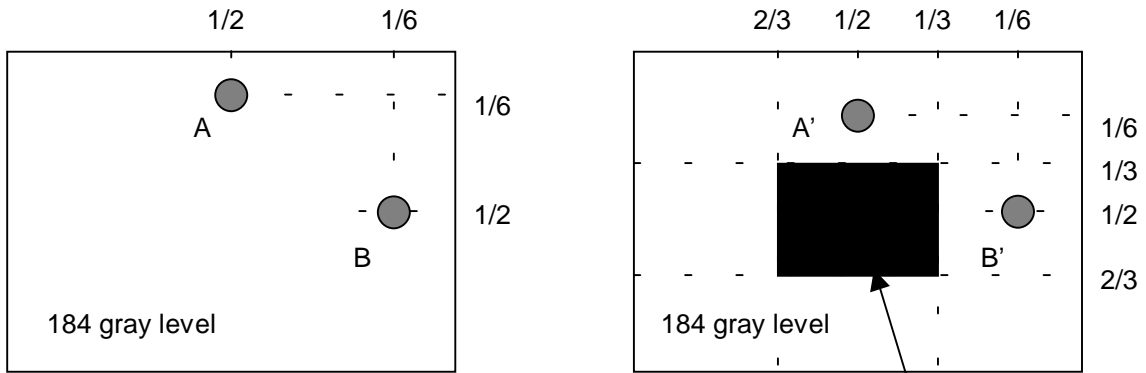

Unit: percentage of dimension of display area

$|L_A - L_{A'}| / L_A \times 100\% = 1.5\% \text{ max.}$ ,  $L_A$  and  $L_B$  are brightness at location A and B

$|L_B - L_{B'}| / L_B \times 100\% = 1.5\% \text{ max.}$ ,  $L_{A'}$  and  $L_{B'}$  are brightness at location A' and B'

**Note 4: Test Patern: Subchecker Pattern**

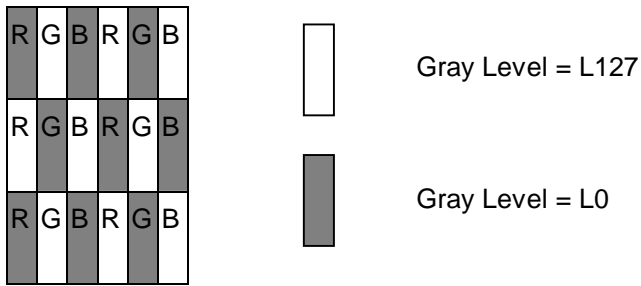

Method: Record dBV & DC value with (WESTAR)TRD-100

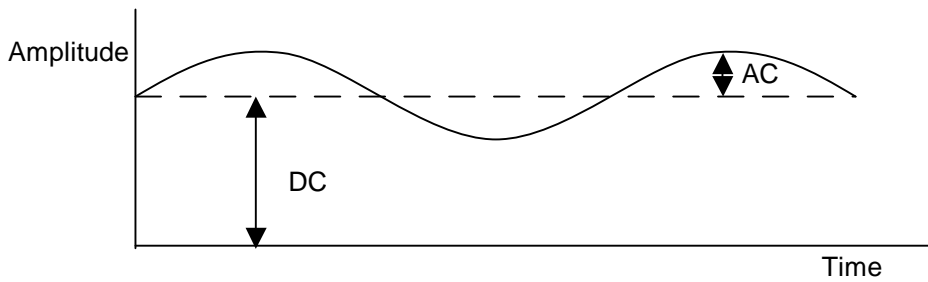

$$\text{Flicker (dB)} = 20 \log \frac{\text{AC Level(at 30 Hz)}}{\text{DC Level}}$$

### 3.0 Functional Block Diagram

The following diagram shows the functional block of the 23.0 inches wide Color TFT/LCD Module:

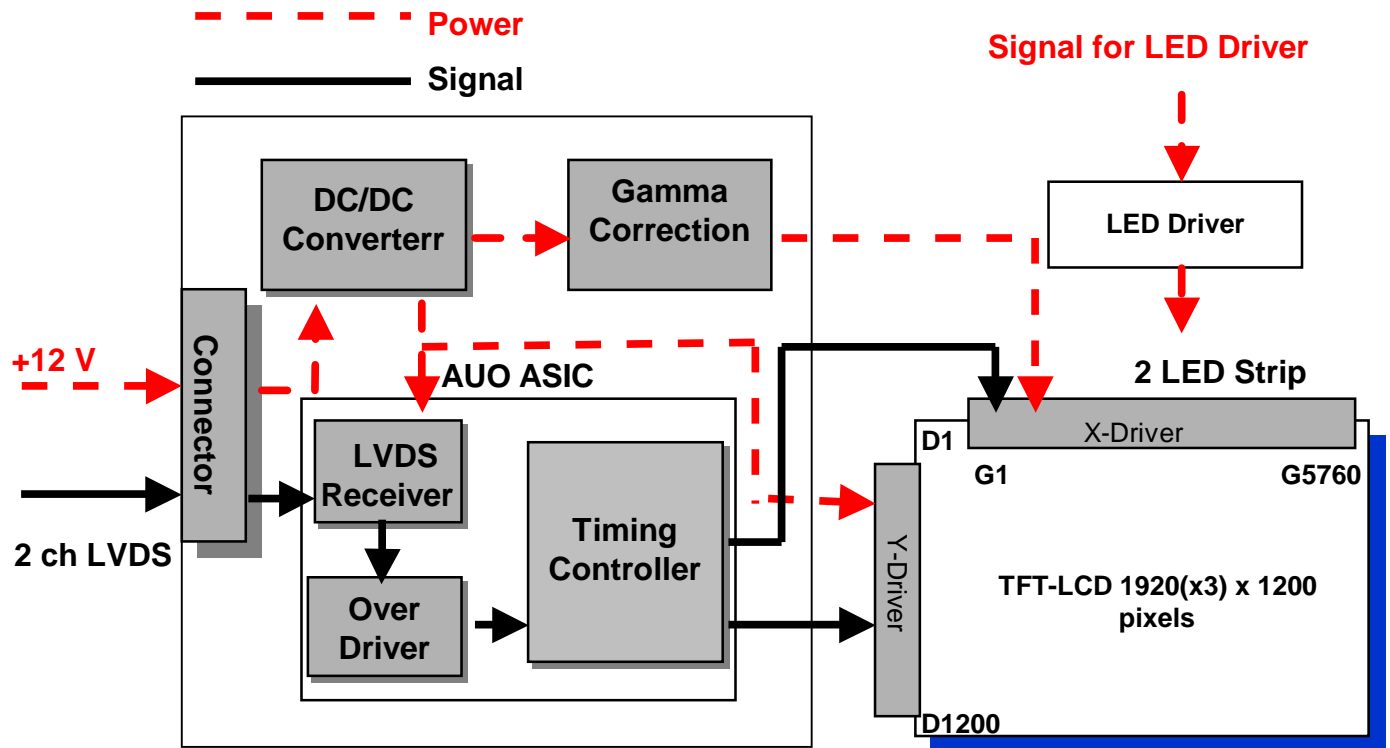

#### I/F PCB Interface:

JAE or compatible FI-X30SSL-HF (On board Strong type)

#### Mating Type:

FI-X30HL-T (Locked Type)  
 FI-X30S-H (Unlocked Type)

#### Backlight Unit

DC input	(J01)	JWT A3963WR2-3P
Enable signal	(J02)	JWT A2502WR02-2P
Master/Slave connection	(J03)	JWT A2502WR02-4P
I2C Interface	(J04)	JWT A2502WR02-4P
LED output	(J06/J07)	JWT A2502WR02-6P

#### Mating Type:

DC input	(J01)	JWT A3963H03-3P
Enable signal	(J02)	JWT A2502H02-2P
Master/Slave connection	(J03)	JWT A2502H02-4P
I2C Interface	(J04)	JWT A2502H02-4P
LED output	(J06/J07)	JWT A2502H02-6P

### 4.0 Absolute Maximum Ratings

Absolute maximum ratings of the module is as following:

#### 4.1 TFT LCD Module

Item	Symbol	Min	Max	Unit	Conditions
Logic/LCD Drive	VIN	+10.8	+13.2	[Volt]	<b>Note 1,2</b>

#### 4.2 Backlight Unit

Item	Symbol	Min	Max	Unit	Conditions
LED R current	$I_{rLED}$	413.2	435	[mA] rms	<b>Note 1,2</b>
LED G current	$I_{gLED}$	456.0	480	[mA] rms	
LED B current	$I_{bLED}$	456.0	480	[mA] rms	

#### 4.3 Absolute Ratings of Environment (TETANTIVE)

Item	Symbol	Min	Max	Unit	Conditions
Operating	TOP	0	40	[°C]	<b>Note 3</b>
Operating Humidity	HOP	8	60	[%RH]	
Storage Temperature	TST	-20	60	[°C]	
Storage Humidity	HST	8	60	[%RH]	

**Note 1:** With in  $T_a$  (25°C )

**Note 2:** Permanent damage to the device may occur if exceed maximum values

**Note 3:** For quality performance, please refer to AUO IIS(Incoming Inspection Standard).

#### Relative Humidity %

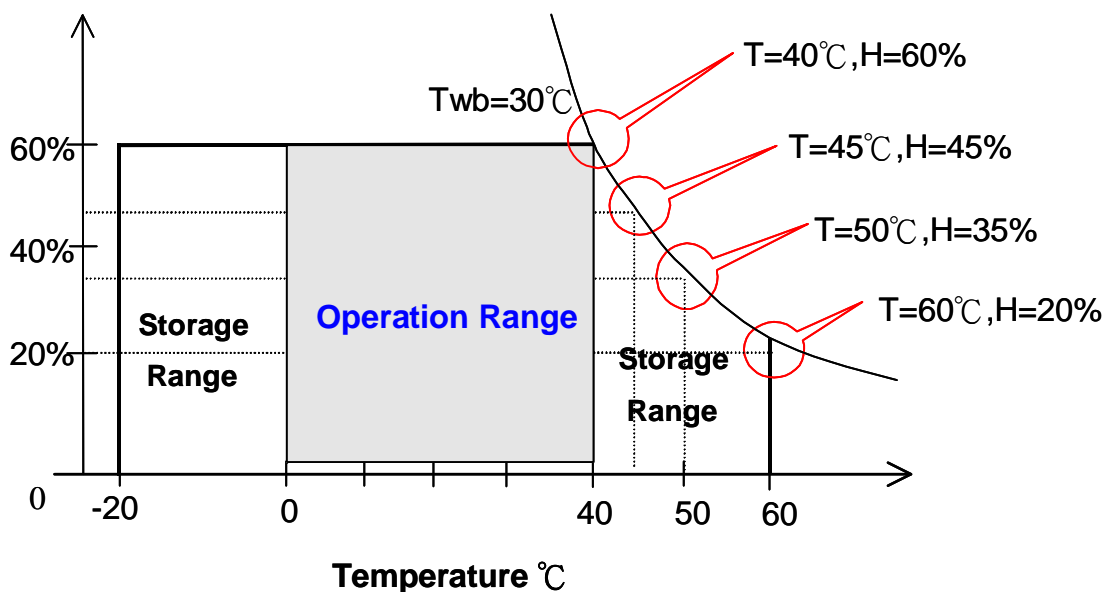

## 5.0 Electrical characteristics

### 5.1 TFT LCD Module

#### 5.1.1 Power Specification

Input power specifications are as follows;

Symbol	Parameter	Min	Typ	Max	Units	Condition
VDD	Logic/LCD Drive Voltage	11.4	12	12.6	[Volt]	±5%
IDD	VDD current	-	850	1200	[mA]	Vin=12V , All White Pattern, +30%, at 60Hz
Irush	LCD Inrush Current	-	-	7.5	[A]	<b>Note</b>
PDD	VDD Power	-	10.2	16	[Watt]	Vin=12V , All White Pattern, +30%, at 60Hz
VDDrp	Allowable Logic/LCD Drive Ripple Voltage	-	-	240	[mV] p-p	

**Note:** Measurement conditions:

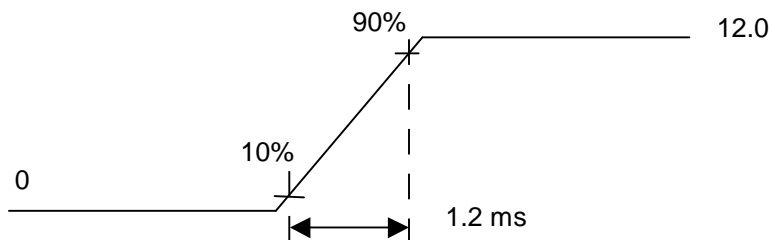
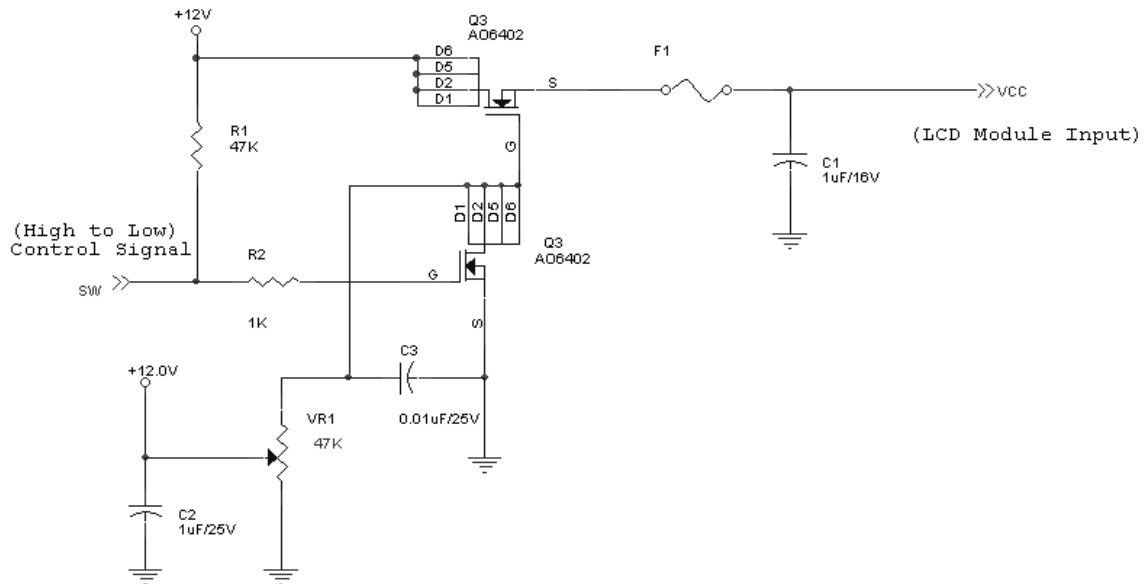

**Vin rising time**

### 5.1.2 Signal Electrical Characteristics

Input signals shall be low or Hi-Z state when  $V_{in}$  is off

It is recommended to refer the specifications of SN75LVDS82DGG (Texas Instruments) in detail.

Each signal characteristics are as follows;

Symbol	Parameter	Min	Typ	Max	Units	Condition
$V_{TH}$	Differential Input High Threshold	-	-	+ 100	[mV]	$V_{ICM} = 1.2V$ <b>Note</b>
$V_{TL}$	Differential Input Low Threshold	- 100	-	-	[mV]	$V_{ICM} = 1.2V$ <b>Note</b>
$ VID $	Input Differential Voltage	100		600	[mV]	<b>Note</b>
$V_{ICM}$	Differential Input Common Mode Voltage	+1.0	+1.2	+1.5	[V]	$V_{TH}/V_{TL} = \pm 200mV$ <b>Note</b>

**Note:** LVDS Signal Waveform

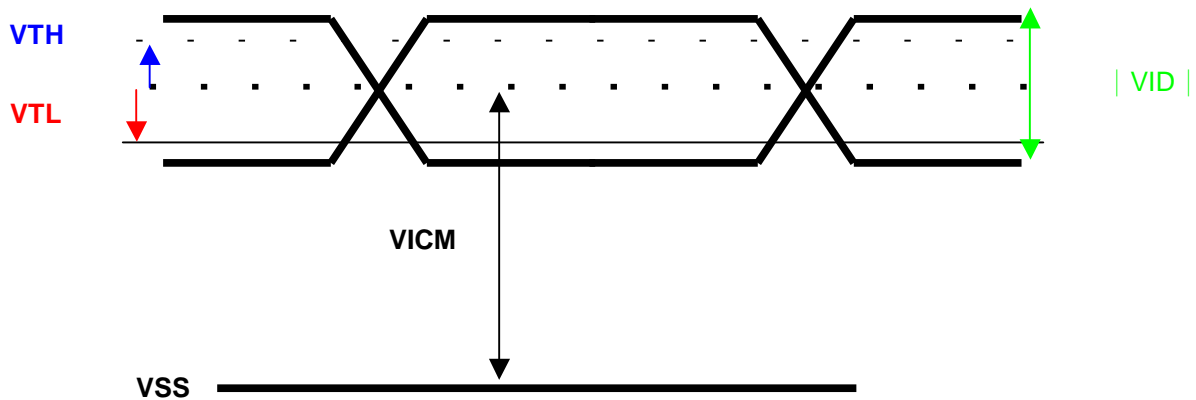

## 5.2 Backlight Unit

Parameter guideline for LED Driver

Symbol	Parameter	Min.	Typ.	Max.	Unit	Condition
IS <sub>rLED</sub>	LED R standard current	413.2	435.0	456.7	[mA] rms	(Ta=25°C) <b>Note 1</b>
IS <sub>gLED</sub>	LED G standard current	456.0	480.0	504.0		
IS <sub>bLED</sub>	LED B standard current	456.0	480.0	504.0		
IR <sub>rLED</sub>	LED R operation range	413.2	435.0	456.7	[mA] rms	(Ta=25°C)
IR <sub>gLED</sub>	LED G operation range	456.0	480.0	504.0		
IR <sub>bLED</sub>	LED B operation range	456.0	480.0	504.0		
F <sub>LED</sub>	LED Frequency	609	610	611	[Hz]	(Ta=25°C) <b>Note 2</b>
V <sub>rLED</sub>	LED R Operation Voltage	13.4	14.7	15.9	[Volt] rms	(Ta=25°C) <b>Note 3</b>
V <sub>gLED</sub>	LED G Operation Voltage	34.4	37.6	40.5		
V <sub>bLED</sub>	LED B Operation Voltage	12.4	13.7	15.9		
P <sub>LED</sub>	LED Power consumption (for reference)	-	124.0	136.0	[Watt]	(Ta=25°C) <b>Note 4</b>
LT <sub>LED</sub>	LED life Time	30,000	50,000	-	[Hour]	(Ta=25°C) <b>Note 5</b>

**Note 1:** LED standard current is measured at 25±2°C..

**Note 2:** LED Frequency should be carefully determined to avoid interference between LED Driver and TFT LCD

**Note 3:** LED operation voltage is measured at 25±2°C.

**Note 4:** The variance of LED power consumption is ± 10%. Calculator value for reference

$$(I_{LEDrms} \times V_{LEDrms} \times 4 \times \text{Duty cycle (100\%)} = P_{LED}).$$

**Note 5:** Definition of life: brightness becomes 50% or less than the minimum luminance value of LED..The typical life time of LED is on the condition at 350.0mA for R and 480mA for G and B driving current.

## 6.0 Signal Characteristic

### 6.1 Pixel Format Image

Following figure shows the relationship of the input signals and LCD pixel format.

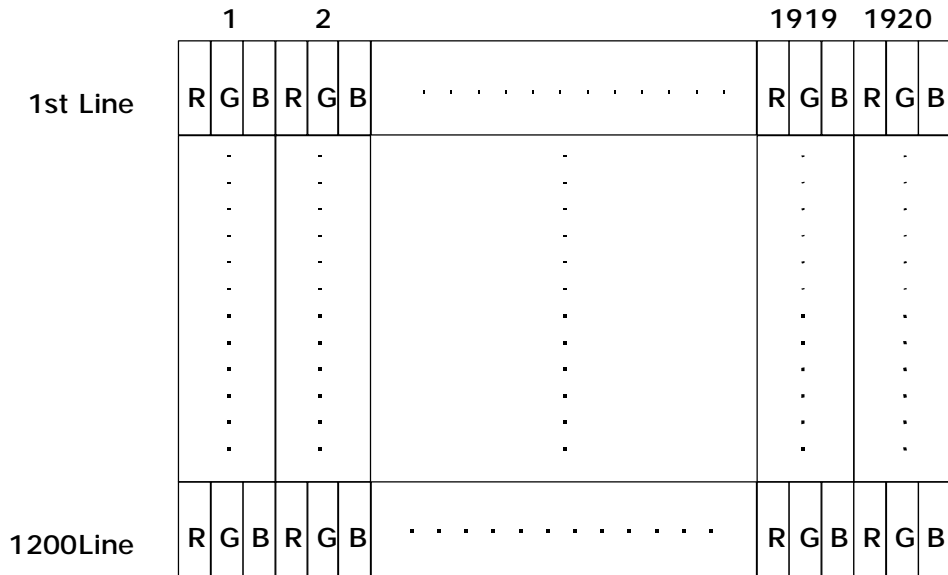

### 6.2 The input data format

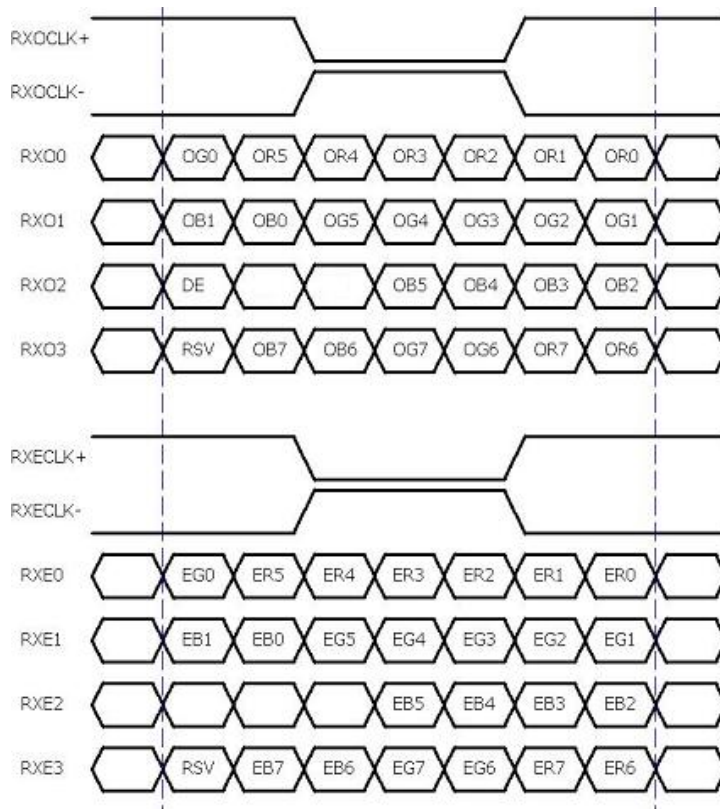

**Note:** R/G/B data 7:MSB, R/G/B data 0:LSB  
 O = "First Pixel Data"  
 E = "Second Pixel Data"

### 6.3 Signal Description

The module using one LVDS receiver SN75LVDS82(Texas Instruments) or compatible. LVDS is a differential signal technology for LCD interface and high speed data transfer device. Transmitter shall be SN75LVDS83(negative edge sampling) or compatible The first LVDS port(RxOxxx) transmits odd pixels while the second LVDS port(RxExxx) transmits even pixels.

PIN	SIGNAL NAME	DESCRIPTION
1	RxOIN0-	Negative LVDS differential data input (Odd data)
2	RxOIN0+	Positive LVDS differential data input (Odd data)
3	RxOIN1-	Negative LVDS differential data input (Odd data)
4	RxOIN1+	Positive LVDS differential data input (Odd data)
5	RxOIN2-	Negative LVDS differential data input (Odd data)
6	RxOIN2+	Positive LVDS differential data input (Odd data)
7	VSS	Power Ground
8	RxOCLK-	Negative LVDS differential clock input (Odd clock)
9	RxOCLK+	Positive LVDS differential clock input (Odd clock)
10	RxOIN3-	Negative LVDS differential data input (Odd data)
11	RxOIN3+	Positive LVDS differential data input (Odd data)
12	RxEIN0-	Negative LVDS differential data input (Even clock)
13	RxEIN0+	Positive LVDS differential data input (Even data)
14	VSS	Power Ground
15	RxEIN1-	Positive LVDS differential data input (Even data)
16	RxEIN1+	Negative LVDS differential data input (Even data)
17	VSS	Power Ground
18	RxEIN2-	Negative LVDS differential data input (Even data)
19	RxEIN2+	Positive LVDS differential data input (Even data)
20	RxECLK-	Negative LVDS differential clock input (Even clock)
21	RxECLK+	Positive LVDS differential clock input (Even clock)
22	RxEIN3-	Negative LVDS differential data input (Even data)
23	RxEIN3+	Positive LVDS differential data input (Even data)
24	VSS	Power Ground
25	NC	No Connection
26	NC	No Connection
27	NC	No Connection
28	VDD	+12.0 V power supply
29	VDD	+12.0 V power supply
30	VDD	+12.0 V power supply

**Note 1:** All GND (ground) pins should be connected together and to VSS which should also be connected to the LCD's metal frame.

**Note 2:** All VDD (power input) pins should be connected together.

**Note 3:** Input signals of odd and even clock shall be the same timing



**Note 4:** The drawing of connector.

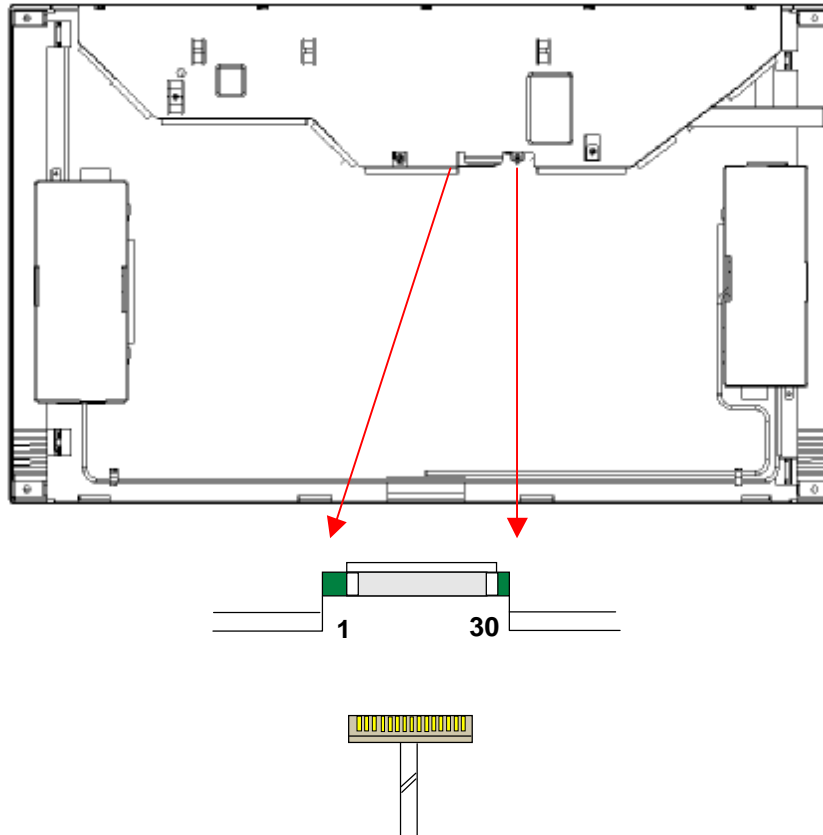

## 6.4 Interface Timing

### 6.4.1 Timing Characteristics

Basically, interface timings described here is not actual input timing of LCD module but output timing of SN75LVDS82DGG (Texas Instruments) or equivalent.

Signal	Item	Symbol	Min	Typ	Max	Unit
Vertical Section	Period	$T_v$	1211	1250	2048	Th
	Active	$T_{disp(v)}$	1200	1200	1200	Th
	Blanking	$T_{bp(v)}+T_{fp(v)}+PW_{vs}$	11	50	-	Th
Horizontal Section	Period	$T_h$	1040	1300	2048	Tclk
	Active	$T_{disp(h)}$	960	960	960	Tclk
	Blanking	$T_{bp(h)}+T_{fp(h)}+PW_{hs}$	80	340	-	Tclk
Clock	Period	$T_{clk}$	11.76	-	-	ns
	Frequency	$F_{req}$	-	-	85	MHz
Frame Rate	Frequency	$F$	55	60	61	Hz

**Note:** DE mode only.

### 6.4.2 Timing diagram

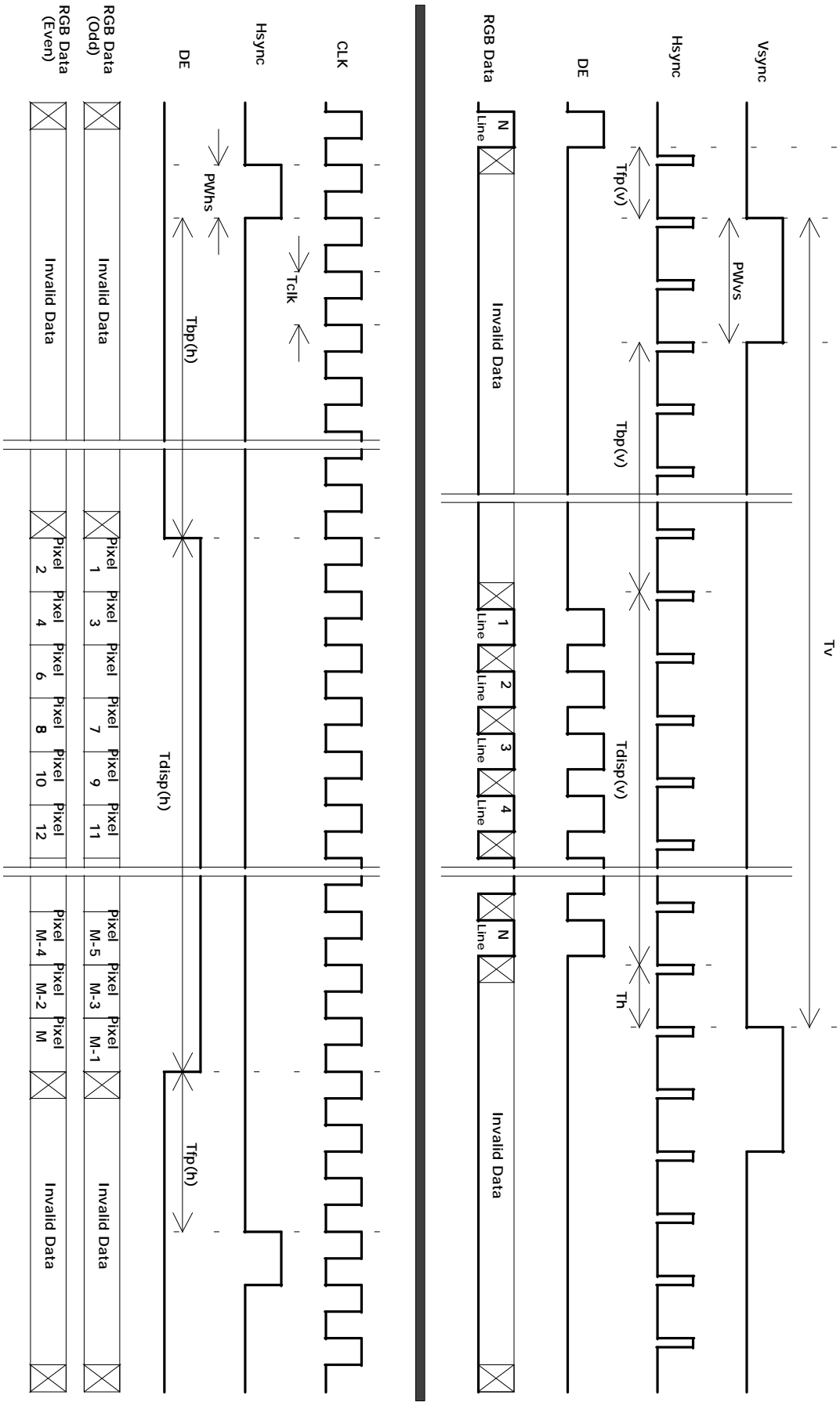

## 6.5 Power ON/OFF Sequence

Vin power and B/L on/off sequence is as follows. Interface signals are also shown in the chart. Signals from any system shall be Hi-Z state or low level when Vin is off.

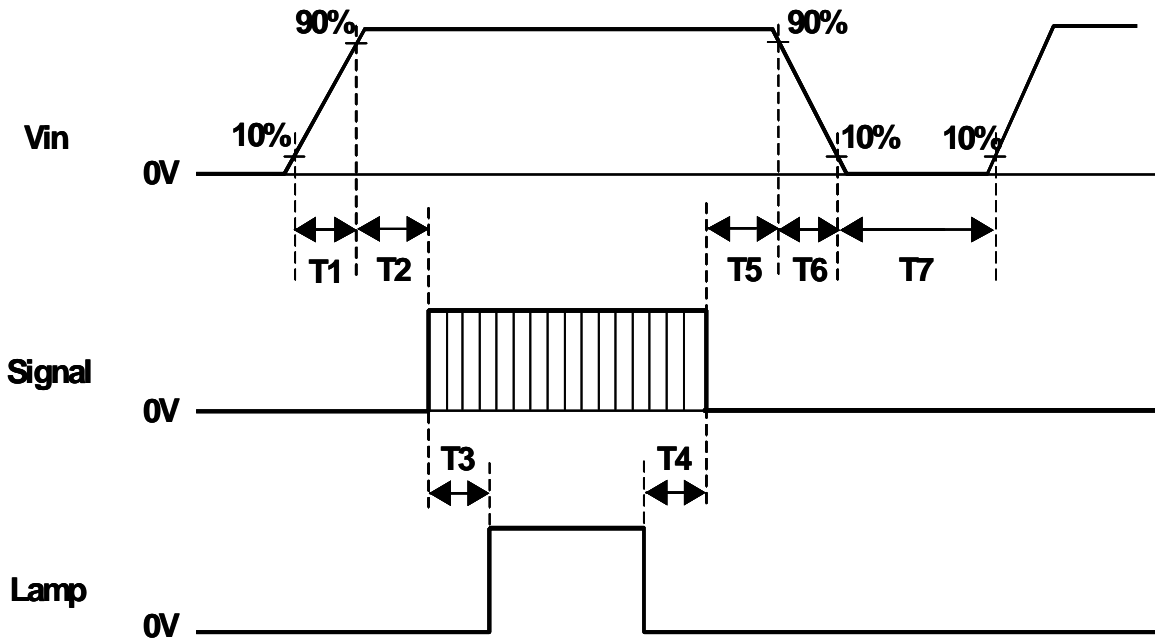

Symbol	Values			Unit
	Min	Typ	Max	
T1	0.5	-	10	[ms]
T2	0.5	40	50	[ms]
T3	300	-	-	[ms]
T4	300	-	-	[ms]
T5	0.5	16	50	[ms]
T6	0.5	-	50	[ms]
T7	1000	-	-	[ms]

## 7.0 Connector & Pin Assignment

Physical interface is described as for the connector on module.

These connectors are capable of accommodating the following signals and will be following components.

### 7.1 TFT LCD Module

<b>Connector Name / Designation</b>	Interface Connector / Interface card
<b>Manufacturer</b>	JAE or compatible
<b>Type Part Number</b>	FI-XB30SL-HF10
<b>Mating Housing Part Number</b>	FI-X30HL-T ( Locked Type ) FI-X30S-H ( Unlocked Type )

### 7.2 Backlight Unit

<b>Connector Name / Designation</b>	LED Driver connector	LED Driver mating connector
<b>DC input (J01)</b>	JWT A3963WR2-3P	JWT A3963H03-3P
<b>Enable signal (J02)</b>	JWT A2502WR02-2P	JWT A2502H02-2P
<b>Master/Slave connection (J03)</b>	JWT A2502WR02-4P	JWT A2502H02-4P
<b>I2C Interface (J04)</b>	JWT A2502WR02-4P	JWT A2502H02-4P
<b>LED output (J06/J07)</b>	JWT A2502WR02-6P	JWT A2502H02-6P

### 7.3 Signal for LED Driver connector

Connector No.	Pin No.	Input	Function
J01	1	12V DC input	+12.0 V Power supply
	2	GND	Power Ground
	3	NC	No Connection
J02	1	In	- A TTL signal L will force the driver into standby mode - A TTL signal H will enable the driver
	2	GND	Power Ground
J03	1	PWM G	PWM signal connection for G LED between Master and Slave
	2	PWM R	PWM signal connection for R LED between Master and Slave
	3	PWM B	PWM signal connection for B LED between Master and Slave
	4	GND	Power Ground
J04	1	+Vcc	5V out
	2	SDA	I2C data
	3	SCL	I2C clock signal
	4	GND	Power Ground
J06/J07	1	R+	Current output driving R LED
	2	R-	Return for R LED only
	3	G+	Current output driving G LED
	4	G-	Return for G LED only
	5	B+	Current output driving B LED
	6	B-	Return for B LED only

## 8.0 Reliability

Reliability item and test condition

No	Test Item	Test Condition	Note
1	Temperature Humidity Bias (THB)	40°C , 60% , 300hours	
2	High Temperature Operation (HTO)	40°C , 300hours	Note
3	Low Temperature Operation (LTO)	0°C , 300hours	
4	High Temperature Storage (HTS)	60°C , 300hours	
5	Low Temperature Storage (LTS)	-20°C , 300hours	
6	Thermal Shock Test (TST)	-20°C/30min, 40°C/30min, 100 cycles	
7	On/Off Test	On/10sec, Off/10sec, 30,000 cycles	
8	Shock Test (Non-Operating)	50G, 11ms, Half-sine wave (± X, ±Y, ±Z)	
9	Vibration Test (Non-Operating)	1G(10~200~10 Hz P-P), 30 Minutes each Axis(X, Y, Z)	
10	ESD (ElectroStatic Discharge)	1. Contact Discharge: ± 8KV, 150pF(330Ω ) 1sec, 8 points, 25 times/ point.	
		2. Air Discharge: ± 15KV, 150pF(330Ω ) 1sec, 8 points, 25 times/ point.	
11	Altitude Test	Operation:10,000 ft Non-Operation:30,000 ft	
12	Drop Test	The drop height is 60cm	

**Note:**

The display module operates error free, when operated under the following conditions;  
 Temperature 0 °C to 40 °C  
 Relative Humidity 8% to 60%  
 Wet Bulb Temperature 39.0 °C  
 (**Condition:** Panel at white pattern and LED Driver 80% output)

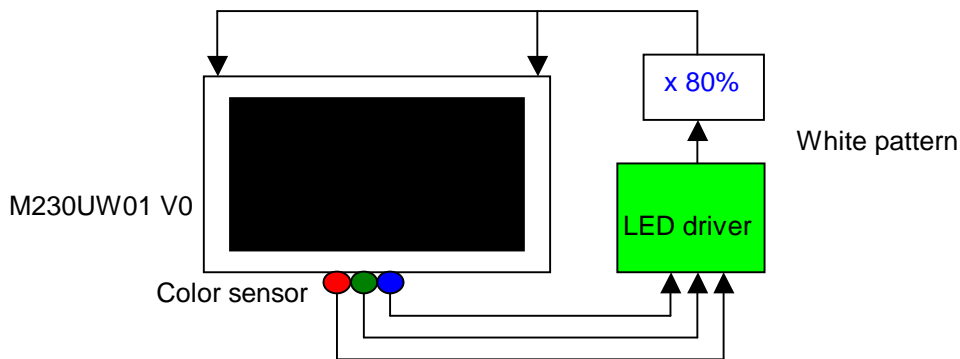

## 9.0 Safety

### 9.1 Sharp Edge Requirements

There will be no sharp edges or comers on the display assembly that could cause injury.

## 9.2 Materials

### 9.2.1 Toxicity

There will be no carcinogenic materials used anywhere in the display module. If toxic materials are used, they will be reviewed and approved by the responsible AUO Toxicologist.

### 9.2.2 Flammability

All components including electrical components that do not meet the flammability grade UL94-V1 in the module will complete the flammability rating exception approval process.

The printed circuit board will be made from material rated 94-V1 or better. The actual UL flammability rating will be printed on the printed circuit board.

## 9.3 Capacitors

If any polarized capacitors are used in the display assembly, provisions will be made to keep them from being inserted backwards.

## 10.0 Other requirement

### 10.1 National Test Lab Requirement

The display module will satisfy all requirements for compliance to

<b>UL 1950, First Edition</b>	U.S.A. Information Technology Equipment
<b>CSA C22.2 No.950-M89</b>	Canada, Information Technology Equipment
<b>EEC 950</b>	International, Information Technology Equipment
<b>EN 60 950</b>	International, Information Processing Equipment (European Norm for IEC950)

### 10.2 Label

The label is on the panel as shown below:

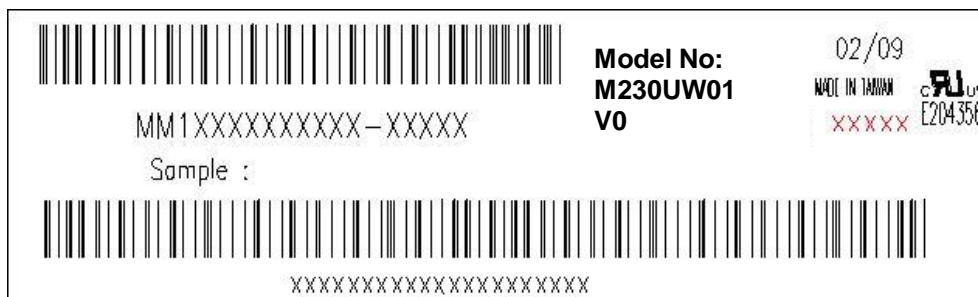





REV	DATE	DESCRIPTION	BY	CHK

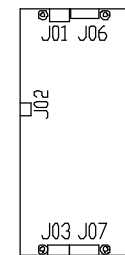
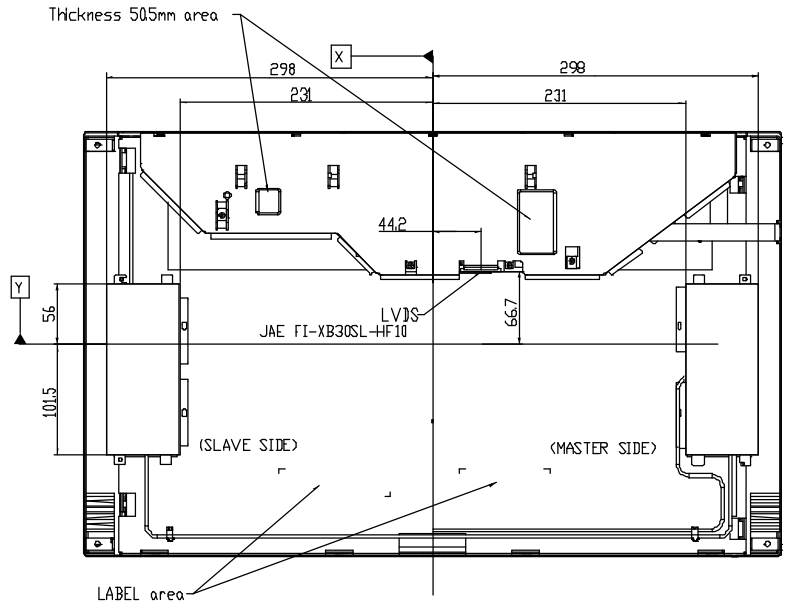

<SLAVE SIDE>

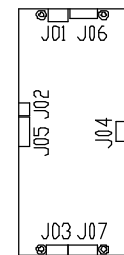

<MASTER SIDE>

LED DRIVER CONNECTOR

SYM	CONNECTOR	DESCRIPTION	NOTE
J01	JWT A3963WR2-3P	12V INPUT	Master/Slave
J02	JWT A2502H02-2P	ENABLE	Master/Slave
J04	JWT A2502H02-4P	I2C INTERFACE	Master only
J05	JST S 6B-PH-K-S	COLOR SENSOR	Master only

This drawing is the property of AU Optonics. It is not to be used, copied, reproduced or distributed without the written permission of AU Optonics.

REV	DATE	DESCRIPTION	BY	CHK

PROJECT		DATE	
DESIGNER		CHECKER	
DRAWING NO.			

REFERENCE

APPEARANCE DRAWING

AU Optonics