

**M2N68-LA
(Narra 3)**

ASUS[®]

Motherboard

Contents

- M2N68-LA (Narra 3) specifications summary iii**
- 1. Motherboard layout..... 1**
- 2. Central Processing Unit (CPU) 2**
 - 2.1 Overview 2
 - 2.2 Installing the CPU 2
- 3. System memory 4**
 - 3.1 Memory configurations..... 4
 - 3.2 Installing a DIMM 5
 - 3.3 Removing a DIMM 5
- 4. Expansion slots 6**
 - 4.1 PCI Express x16 slot..... 6
 - 4.2 PCI Express x1 slot..... 6
 - 4.3 PCI slots..... 6
- 5. Jumpers 7**
- 6. Connectors 9**
 - 6.1 Rear panel connectors..... 9
 - 6.2 Internal connectors 11

M2N68-LA (Narra 3) specifications summary

CPU	Socket AM2 for AMD Athlon™ 64 / Athlon™ 64 X2 / Sempron™ Rev F / Rev G 89W/ Phenom X4 9600 95W/ Phenom X2 65W and 89W (Socket-AM2+) processor CPU FSB supports up to 2000MT/sec
Chipset	NVIDIA® MCP61P (co-layout with MCP68)
Memory	Dual-channel memory architecture 4 x 240-pin DIMM sockets support up to 8 GB non-ECC 1.8V Dual Channel DDR2 800/667 SDRAM memory (registered DIMMs are not supported)
Expansion slots	1 x PCI Express™ x16 slot for discrete graphics card 2 x PCI Express™ x1 slot 1 x PCI slots
Onboard I/O	1 x PS/2 keyboard port 1 x PS/2 mouse port 1 x VGA port 6 x Audio jacks 1 x RJ-45 10/100 LAN connector 10 x USB 2.0 ports (support hot-plug function) 1 x Floppy connector 1 x IDE connector 4 x SATA 3G connectors
Onboard IDE	NVIDIA® MCP61 embedded one channel Bus Master IDE port supports Ultra DMA 66/100, PIO Mode 3/4 NVIDIA® MCP61 embedded 4 SATA ports ATAPI IDE DVD-ROM, CD-ROM, CD-R, CD-RW and LS-120 supported
Onboard audio	Supports HD audio codec that includes line-in, line-out (7.1 channel), microphone-in, and S/PDIF-out Audio Jack Presence Detection (all front and rear jacks) must comply with Intel® High Definition audio specification 1.0 section 7.4.2 Using Realtek® audio codec ALC888S
Onboard LAN	Realtek® RTL8201n 10/100Mbps Ethernet PHY
PC health monitoring	ASUS F8000 for CPU/System fan control, linear fan speed control and CPU temperature monitoring

(continued on the next page)

M2N68-LA (Narra 3) specifications summary

Front panel and back panel	<p>Front panel:</p> <ul style="list-style-type: none"> 1 x 9-pin header for Power Button, Reset Button, Power LED, HDD LED 2 x 9-pin header for USB front panel (4 ports) 2 x 4-pin header for USB mini PMD use (2 ports) 1 x 9-pin header for Audio 1 x 9-pin header for IEEE 1394 <p>Back panel:</p> <ul style="list-style-type: none"> 1 x PS/2 keyboard 1 x PS/2 mouse 1 x 15-pin VGA 2 x USB + RJ-45 LAN connector 2 x USB + 1 x IEEE 1394 Azalia 6 ports audio jack: 4 x Line-out, 1 x Line-in, 1 x Mic-in (with jack retasking support)
Onboard connector	<ul style="list-style-type: none"> 24-pin ATX power connector 4-pin ATX 12V power connector 1 x Intel® HD audio front panel 2x5-pin header 1 x Front line-in 2 x USB front panel 9-pin headers 2 x USB front panel 4-pin headers 1 x IEEE 1394 9-pin header 1 x S/PDIF-out (for HDMI) 1 x HDMI 2x8-pin header 1 x CPU fan connector 1 x System fan connector
BIOS features	<ul style="list-style-type: none"> Award code base 4Mb SPI Serial Flash HP BIOS with Enhanced ACPI, DMI, Green, PnP Features Plus
Form factor	<p>uATX form factor: 9.6" x 9.6"</p>

*Specifications are subject to change without notice.

1. Motherboard layout

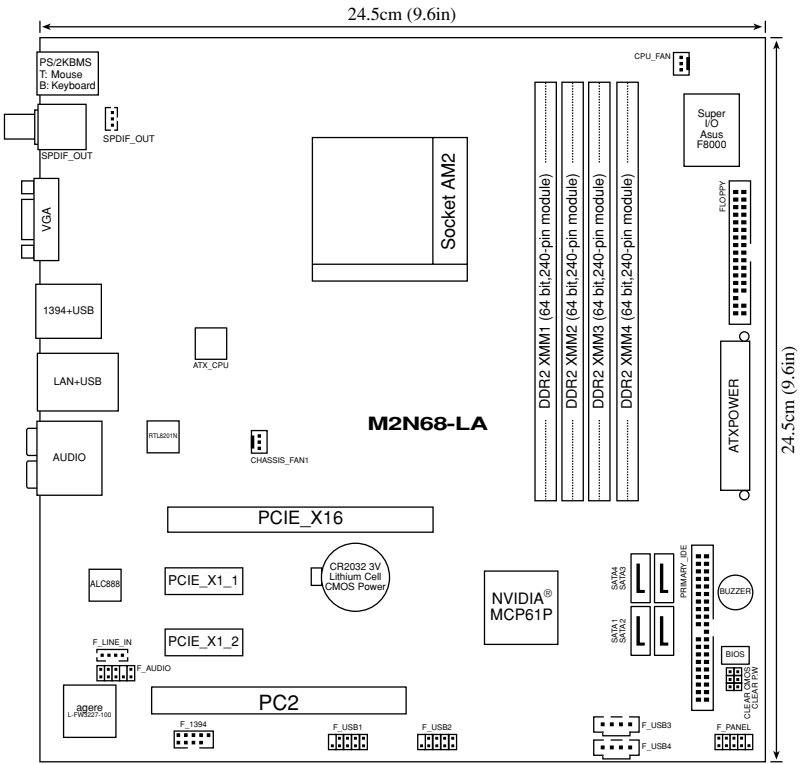

2. Central Processing Unit (CPU)

2.1 Overview

The motherboard comes with a 940-pin AM2 socket designed for the AMD Athlon™ 64/ Athlon™ 64 X2/Sempron™ Rev F/Rev G 89W processor.



The AM2 socket has a different pinout from the 940-pin socket designed for the AMD Opteron™ processor. Make sure you use a CPU designed for the AM2 socket. The CPU fits in only one correct orientation. DO NOT force the CPU into the socket to prevent bending the connectors on the socket and damaging the CPU!

2.2 Installing the CPU

To install a CPU:

1. Locate the CPU socket on the motherboard.

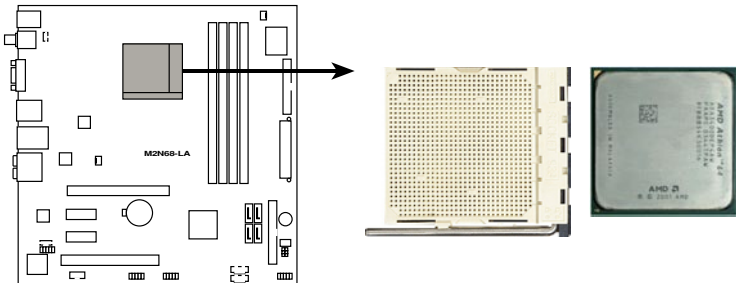

M2N68-LA CPU Socket AM2

2. Unlock the socket by pressing the lever sideways, then lift it up to a 90° angle.

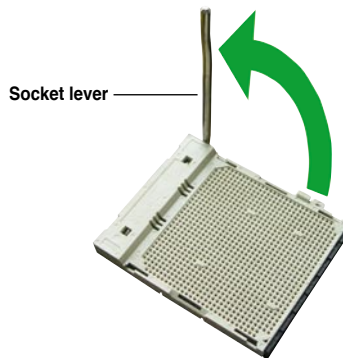

Make sure that the socket lever is lifted up to a 90° angle; otherwise, the CPU will not fit in completely.

3. Position the CPU above the socket such that the CPU corner with the gold triangle matches the socket corner with a small triangle.
4. Carefully insert the CPU into the socket until it fits in place.

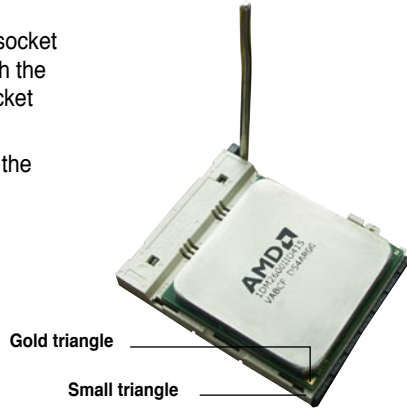

5. When the CPU is in place, push down the socket lever to secure the CPU. The lever clicks on the side tab to indicate that it is locked.
6. Install a CPU heatsink and fan following the instructions that came with the heatsink package.



3. System memory

The motherboard comes with four Double Data Rate 2 (DDR2) Dual Inline Memory Modules (DIMM) sockets.

A DDR2 module has the same physical dimensions as a DDR DIMM but has a 240-pin footprint compared to the 184-pin DDR DIMM. DDR2 DIMMs are notched differently to prevent installation on a DDR DIMM socket.

The following figure illustrates the location of the DDR2 DIMM sockets:

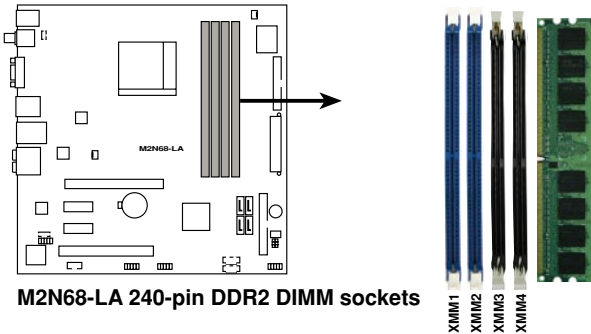

3.1 Memory configurations

You may install 256 MB, 512 MB, and 1 GB DDR2 SDRAM DIMMs into the DIMM sockets.



- Always use **identical** (the same type and size) DDR2 DIMM pairs for dual channel mode. For optimum compatibility, we recommend that you obtain memory modules from the same vendor.
- This motherboard does not support double-sided 16-bit DDR DIMMs.

3.2 Installing a DIMM



Unplug the power supply before adding or removing DIMMs or other system components. Failure to do so can cause severe damage to both the motherboard and the components.

To install a DIMM:

1. Unlock a DIMM socket by pressing the retaining clips outward.
2. Align a DIMM on the socket such that the notch on the DIMM matches the break on the socket.
3. Firmly insert the DIMM into the socket until the retaining clips snap back in place and the DIMM is properly seated.

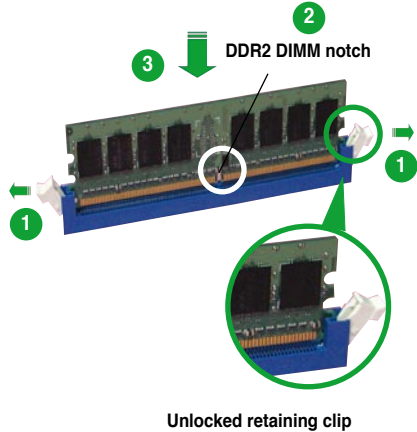

Unlocked retaining clip



- A DDR2 DIMM is keyed with a notch so that it fits in only one direction. Do not force a DIMM into a socket to avoid damaging the DIMM.
- The DDR2 DIMM sockets do not support DDR DIMMs. DO not install DDR DIMMs to the DDR2 DIMM sockets.

3.3 Removing a DIMM

To remove a DIMM:

1. Simultaneously press the retaining clips outward to unlock the DIMM.



Support the DIMM lightly with your fingers when pressing the retaining clips. The DIMM might get damaged when it flips out with extra force.

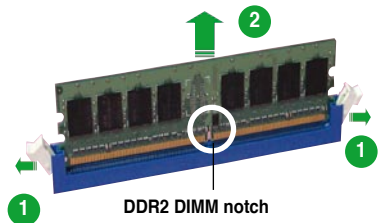

2. Remove the DIMM from the socket.

4. Expansion slots

4.1 PCI Express x16 slot

This motherboard supports PCI Express x16 graphic cards that comply with the PCI Express specifications. The figure shows a graphics card installed on the PCI Express x16 slot.

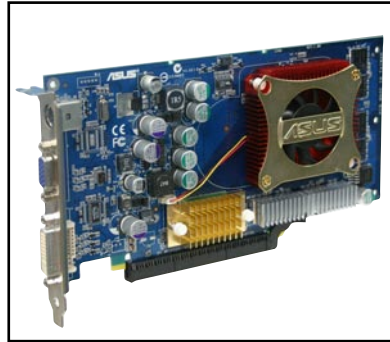

4.2 PCI Express x1 slot

This motherboard supports PCI Express x1 network cards, SCSI cards and other cards that comply with the PCI Express specifications. The figure shows a network card installed on the PCI Express x1 slot.

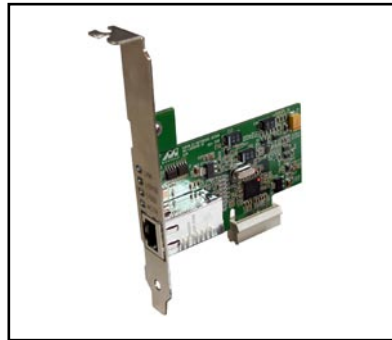

4.3 PCI slots

The PCI slots support cards such as a LAN card, SCSI card, USB card, and other cards that comply with PCI specifications. The figure shows a LAN card installed on a PCI slot.

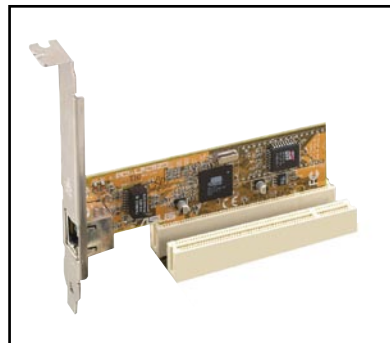

5. Jumpers

1. Clear RTC RAM (3-pin CLRRTC)

This jumper allows you to clear the Real Time Clock (RTC) RAM in CMOS. You can clear the CMOS memory of date, time, and system setup parameters by erasing the CMOS RTC RAM data. The onboard button cell battery powers the RAM data in CMOS, which include system setup information such as system passwords.

To erase the RTC RAM:

1. Turn OFF the computer and unplug the power cord.
2. Remove the onboard battery.
3. Move the jumper cap from pins 2-3 (Normal) to pins 1-2 (Clear CMOS). Keep the cap on pins 1-2 for about 5~10 seconds, then move the cap back to pins 2-3.
4. Reinstall the battery.
5. Plug the power cord and turn ON the computer.
6. Hold down the <F1> key during the boot process and enter BIOS setup to re-enter data.



Except when clearing the RTC RAM, never remove the cap on CLRRTC jumper default position. Removing the cap will cause system boot failure!

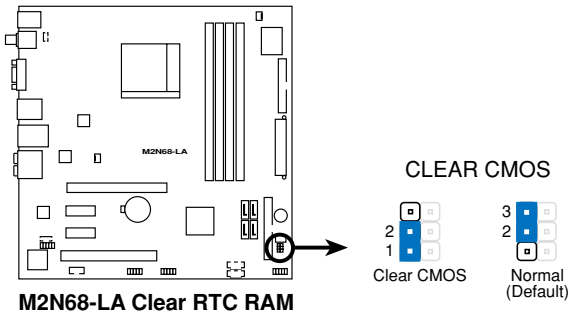

2. Clear password (3-pin CLRPW)

This jumper allows you to clear the password if you forgot your password.

To erase the password:

1. Turn OFF the computer and unplug the power cord.
2. Move the jumper cap from pins 2-3 (Normal) to pins 1-2 (Clear Password).
3. Plug the power cord and turn ON the computer.
4. After the computer boots up, turn OFF the computer.
5. Move the jumper cap from pins 1-2 to pins 2-3.
6. Hold down the <F1> key during the boot process and enter BIOS setup to verify that the password has been cleared.

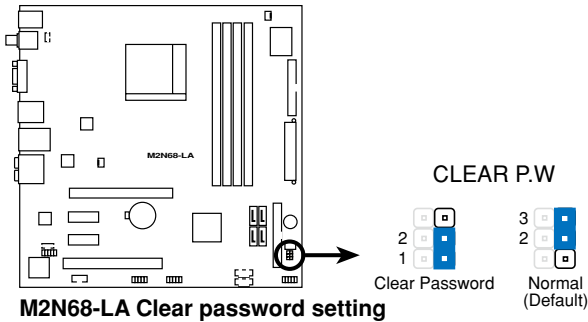

6. Connectors

6.1 Rear panel connectors

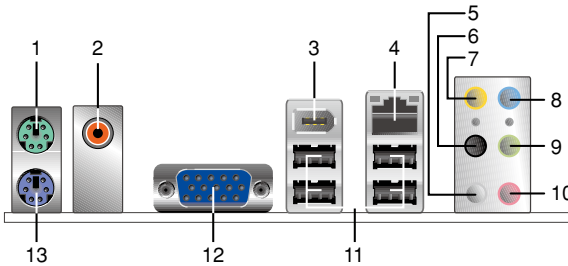

1. **PS/2 mouse port (green).** This port is for a PS/2 mouse.
2. **Coaxial S/PDIF Out port.** This port connects an external audio output device via a coaxial S/PDIF cable.
3. **IEEE 1394a port.** This 6-pin IEEE 1394a port provides high-speed connectivity for audio/video devices, storage peripherals, PCs, or portable devices.
4. **LAN (RJ-45) port.** This port allows 10/100 connection to a Local Area Network (LAN) through a network hub. Refer to the table below for the LAN port LED indications.

LAN port LED indications

LINK LED		ACT LED	
Status	Description	Status	Description
OFF	No link	OFF	Not Transmitting
GREEN	Linked	ORANGE	Transmitting

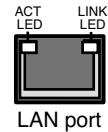

5. **Side Speaker Out port (gray).** This port connects to the side speakers in an 8-channel audio configuration.
6. **Rear Speaker Out port (black).** This port connects to the rear speakers on a 4-channel, 6-channel, or 8-channel audio configuration.
7. **Center/Subwoofer port (yellow orange).** This port connects the center/subwoofer speakers.
8. **Line In port (light blue).** This port connects the tape, CD, DVD player, or other audio sources.
9. **Line Out port (lime).** This port connects a headphone or a speaker. In 4-channel, 6-channel, and 8-channel mode, the function of this port becomes Front Speaker Out.
10. **Microphone port (pink).** This port connects a microphone.



Refer to the audio configuration table for the function of the audio ports in 2, 4, 6, or 8-channel configuration.

Audio 2, 4, 6, or 8-channel configuration

Port	Headset 2-channel	4-channel	6-channel	8-channel
Light Blue	Line In	Line In	Line In	Line In
Lime	Line Out	Front Speaker Out	Front Speaker Out	Front Speaker Out
Pink	Mic In	Mic In	Mic In	Mic In
Orange	–	–	Center/Subwoofer	Center/Subwoofer
Black	–	Rear Speaker Out	Rear Speaker Out	Rear Speaker Out
Gray	–	–	–	Side Speaker Out

- 11. USB 2.0 ports.** These four 4-pin Universal Serial Bus (USB) ports are available for connecting USB 2.0 devices.
- 12. VGA port.** This 15-pin VGA port connects to a VGA monitor.
- 13. PS/2 keyboard port (purple).** This port is for a PS/2 keyboard.

6.2 Internal connectors

This section describes and illustrates the internal connectors on the motherboard.

1. Floppy disk drive connector (34-1 pin FLOPPY)

This connector is for the provided floppy disk drive (FDD) signal cable. Insert one end of the cable to this connector, then connect the other end to the signal connector at the back of the floppy disk drive.



Pin 5 on the connector is removed to prevent incorrect cable connection when using a FDD cable with a covered Pin 5.

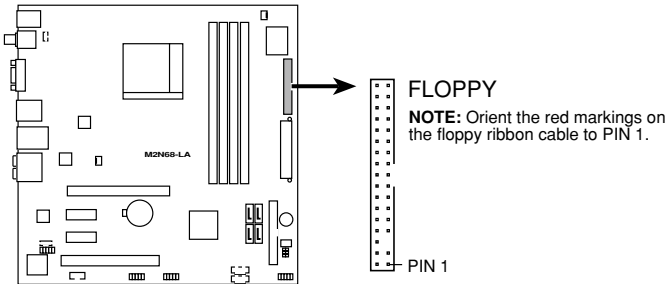

M2N68-LA Floppy disk drive connector

2. IDE connector (40-1 pin PRIMARY_IDE)

The onboard IDE connector is for the Ultra DMA 133/100/66 signal cable. There are three connectors on each Ultra DMA 133/100/66 signal cable: blue, black, and gray. Connect the blue connector to the motherboard's IDE connector, then select one of the following modes to configure your device.

	Drive jumper setting	Mode of device(s)	Cable connector
Single device	Cable-Select or Master	-	Black
Two devices	Cable-Select	Master	Black
		Slave	Gray
	Master	Master	Black or gray
		Slave	



- Pin 20 on the IDE connector is removed to match the covered hole on the Ultra DMA cable connector. This prevents incorrect insertion when you connect the IDE cable.
- Use the 80-conductor IDE cable for Ultra DMA 100/66 IDE devices.



If any device jumper is set as "Cable-Select," make sure all other device jumpers have the same setting.

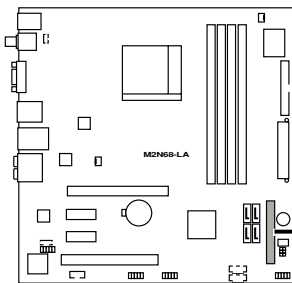

M2N68-LA IDE connector



PRIMARY_IDE

NOTE: Orient the red markings (usually zigzag) on the IDE ribbon cable to PIN 1.

PIN 1

3. ATX power connectors (24-pin ATXPOWER, 4-pin ATX_CPU)

These connectors are for ATX power supply plugs. The power supply plugs are designed to fit these connectors in only one orientation. Find the proper orientation and push down firmly until the connectors completely fit.

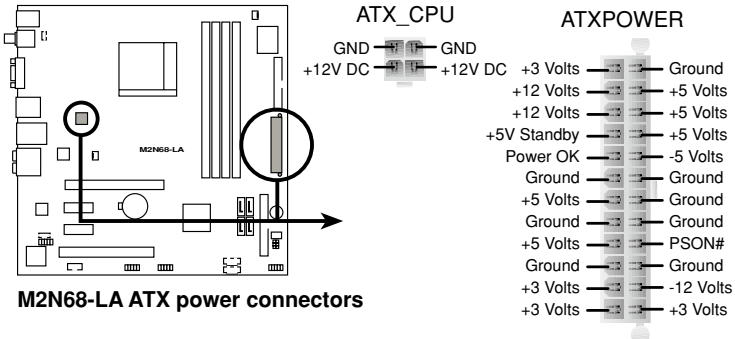

M2N68-LA ATX power connectors



- Do not forget to connect the 4-pin ATX +12 V power plug; otherwise, the system will not boot up.
- Make sure that your ATX 12V power supply can provide 8A on the +12V lead and at least 1A on the +5-volt standby lead (+5VSB). The minimum recommended wattage is 230 W, or 300W for a fully configured system. The system can become unstable and might experience difficulty powering up if the power supply is inadequate.
- Use of a PSU with a higher power output is recommended when configuring a system with more power-consuming devices. The system may become unstable or may not boot up if the power is inadequate.

4. Serial ATA connectors (7-pin SATA1, SATA2, SATA3, SATA4)

These connectors are for the Serial ATA signal cables for Serial ATA hard disk drives.

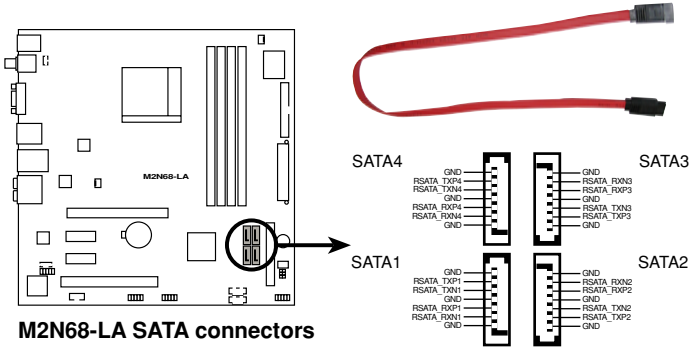

You must install Windows® 2000 Service Pack 4 or the Windows® XP Service Pack1 before using Serial ATA hard disk drive.

5. USB connectors (10-1 pin P24 F_USB1, 10-1 pin P150 F_USB2, 5-1 pin P151 F_USB1, 5-1 pin P152 F_USB2)

These connectors are for USB 2.0 ports. Connect the USB/GAME module cable to any of these connectors, then install the module to a slot opening at the back of the system chassis. These USB connectors comply with USB 2.0 specification that supports up to 480 Mbps connection speed.

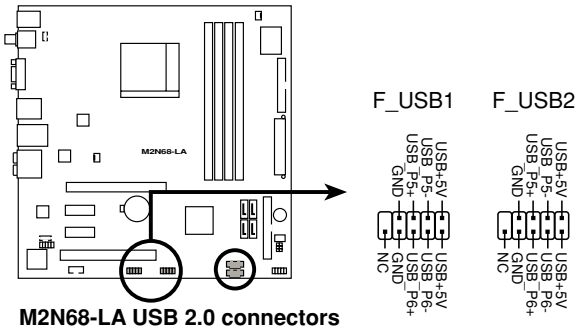

Never connect a 1394 cable to the USB connectors. Doing so will damage the motherboard!

6. CPU and Chassis fan connectors (3-pin CPU_FAN, 3-pin CHASSIS_FAN1)

The fan connectors support cooling fans of 350mA~740mA (8.88W max.) or a total of 1A~2.22A (26.64W max.) at +12V. Connect the fan cables to the fan connectors on the motherboard, making sure that the black wire of each cable matches the ground pin of the connector.



Do not forget to connect the fan cables to the fan connectors. Insufficient air flow inside the system may damage the motherboard components. These are not jumpers! DO NOT place jumper caps on the fan connectors.

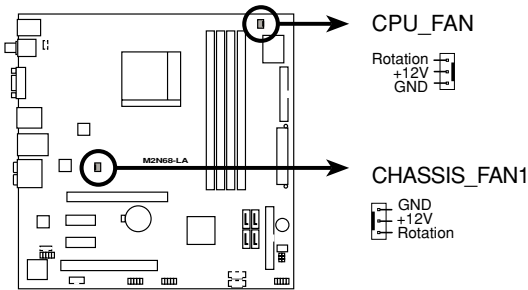

M2N68-LA Fan connectors

7. Front panel audio connector (10-1 pin F_AUDIO)

This connector is for a chassis-mounted front panel audio I/O module that supports Azalia audio standard.

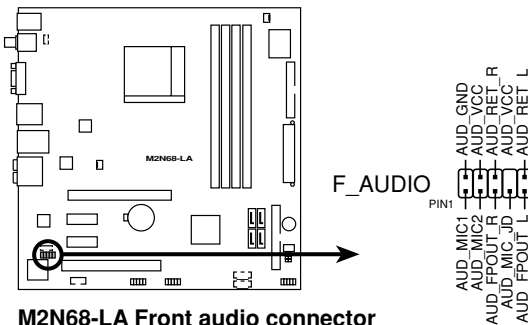

M2N68-LA Front audio connector

8. Internal audio connector (4-pin F_LINE_IN)

This connector allows you to receive stereo audio input from sound sources such as a CD-ROM, TV tuner, or MPEG card.

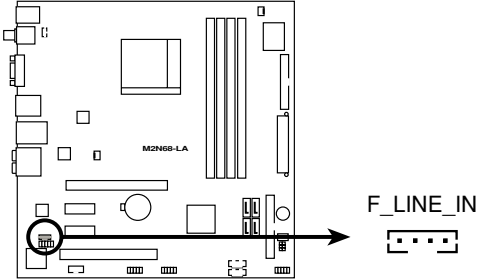

M2N68-LA Internal audio connector

9. System panel connector (10-1 pin F_PANEL)

This connector supports several chassis-mounted functions.

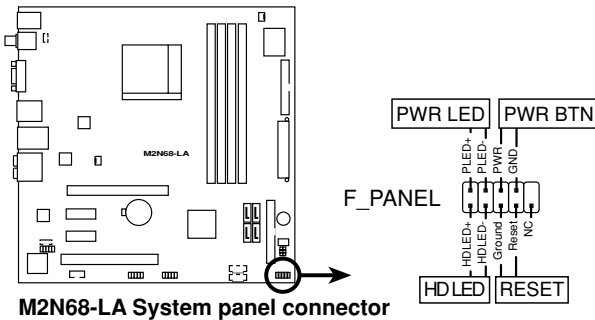

- **System power LED (2-pin PLED)**

This 2-pin connector is for the system power LED. Connect the chassis power LED cable to this connector. The system power LED lights up when you turn on the system power, and blinks when the system is in sleep mode.

- **Hard disk drive activity LED (2-pin HDLED)**

This 2-pin connector is for the HDD Activity LED. Connect the HDD Activity LED cable to this connector. The IDE LED lights up or flashes when data is read from or written to the HDD.

- **ATX power button/soft-off button (2-pin PWR)**

This connector is for the system power button. Pressing the power button turns the system on or puts the system in sleep or soft-off mode depending on the BIOS settings. Pressing the power switch for more than four seconds while the system is ON turns the system OFF.

- **Reset button (2-pin RESET)**

This 2-pin connector is for the chassis-mounted reset button for system reboot without turning off the system power.

