

MITSUBISHI MICROCOMPUTERS M35046-XXXSP/FP

SCREEN CHARACTER and PATTERN DISPLAY CONTROLLERS

DESCRIPTION

The M35046-XXXSP/FP is a character pattern display control IC can display on the liquid crystal display and the plasma display. It uses a silicon gate CMOS process and it housed in a 20-pin shrink DIP package (M35046-XXXSP) or a 20-pin shrink SOP package (M35046-XXXFP).

For M35046-001SP/FP that is a standard ROM version of M35046-XXXSP/FP respectively, the character pattern is also mentioned.

FEATURES

- Screen composition 24 columns × 12 lines
- Number of characters displayed 288 (Max.)
- Character composition 12 × 18 dot matrix
- Characters available 256 characters
- Character sizes available 4 (horizontal) × 4 (vertical)
- Display locations available
 - Horizontal direction 1000 locations
 - Vertical direction 1023 locations
- Blinking Character units
 - Cycle : division of vertical synchronization signal into 32 or 64
 - Duty : 25%, 50%, or 75%
- Data input By the 16-bit serial input function
- Coloring
 - Character color Character unit
 - Background coloring Character unit
 - Matrix-outline (shadow) coloring 8 colors (RGB output)
 - Specified by register
 - Border coloring 8 colors (RGB output)
 - Specified by register
 - Raster coloring 8 colors (RGB output)
 - Specified by register
- Blanking
 - Character size blanking
 - Border size blanking
 - Matrix-outline blanking
 - All blanking (all raster area)
- Output ports
 - 4 shared output ports (toggled between RGB output)
 - 4 dedicated output ports
- Display RAM erase function
- Display input frequency range Fosc = 20MHz to 80MHz
- Horizontal synchronous input frequency
 - H.sync = 15 kHz to 130 kHz
- Display oscillation stop function

APPLICATION

Liquid crystal display, Plasma display, Video projector

PIN CONFIGURATION (TOP VIEW)

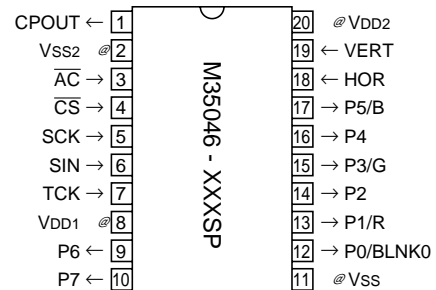

Outline 20P4B

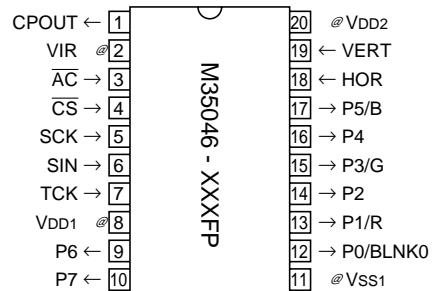

Outline 20P2Q-A

PIN DESCRIPTION

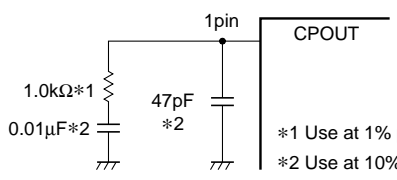
Pin Number	Symbol	Pin name	Input/Output	Function
1	CPOUT	Phase difference	Output	<p>Connect loop filter to this pin.</p>  <p>*1 Use at 1% precision *2 Use at 10% precision</p>
2	VSS2	Earthing pin	–	Connect to GND.
3	\overline{AC}	Auto-clear input	Input	When "L", this pin resets the internal IC circuit. Hysteresis input. Built-in pull-up resistor.
4	\overline{CS}	Chip select input	Input	This is the chip select input pin, and when serial data transmission is being carried out, it goes to "L". Hysteresis input. Built-in pull-up resistor.
5	SCK	Serial clock input	Input	When \overline{CS} pin is "L", SIN serial data is taken in when SCK rises. Hysteresis input. Built-in pull-up resistor.
6	SIN	Serial data input	Input	This is the pin for serial input of data and addresses for the display control register and the display data memory. Hysteresis input. Built-in pull-up resistor.
7	TCK	External clock	Input	This is the pin for external clock input.
8	VDD1	Power pin	–	Please connect to +5V with the power pin.
9	P6	Port P6 output	Output	This is the output port. Port data is set by PTD6.
10	P7	Port P7 output	Output	This is the output port. Port data is set by PTD7.
11	VSS1	Earthing pin	–	Please connect to GND using circuit earthing pin.
12	P0/BLNK0	Port P0 output	Output	This pin can be toggled between port pin output and BLNK0 signal output.
13	P1/R	Port P1 output	Output	This pin can be toggled between port pin output and R signal output.
14	P2	Port P2 output	Output	This is the output port. Port data is set by PTD2.
15	P3/G	Port P3 output	Output	This pin can be toggled between port pin output and G signal output.
16	P4	Port P4 output	Output	This is the output port. Port data is set by PTD4.
17	P5/B	Port P5 output	Output	This pin can be toggled between port pin output and B signal output.
18	HOR	Horizontal synchronous signal input	Input	This pin inputs the horizontal synchronous signal. Hysteresis input.
19	VERT	Vertical synchronous signal input	Input	This pin inputs the vertical synchronous signal. Hysteresis input.
20	VDD2	Power pin	–	Please connect to +5V with the power pin.

SCREEN CHARACTER and PATTERN DISPLAY CONTROLLERS

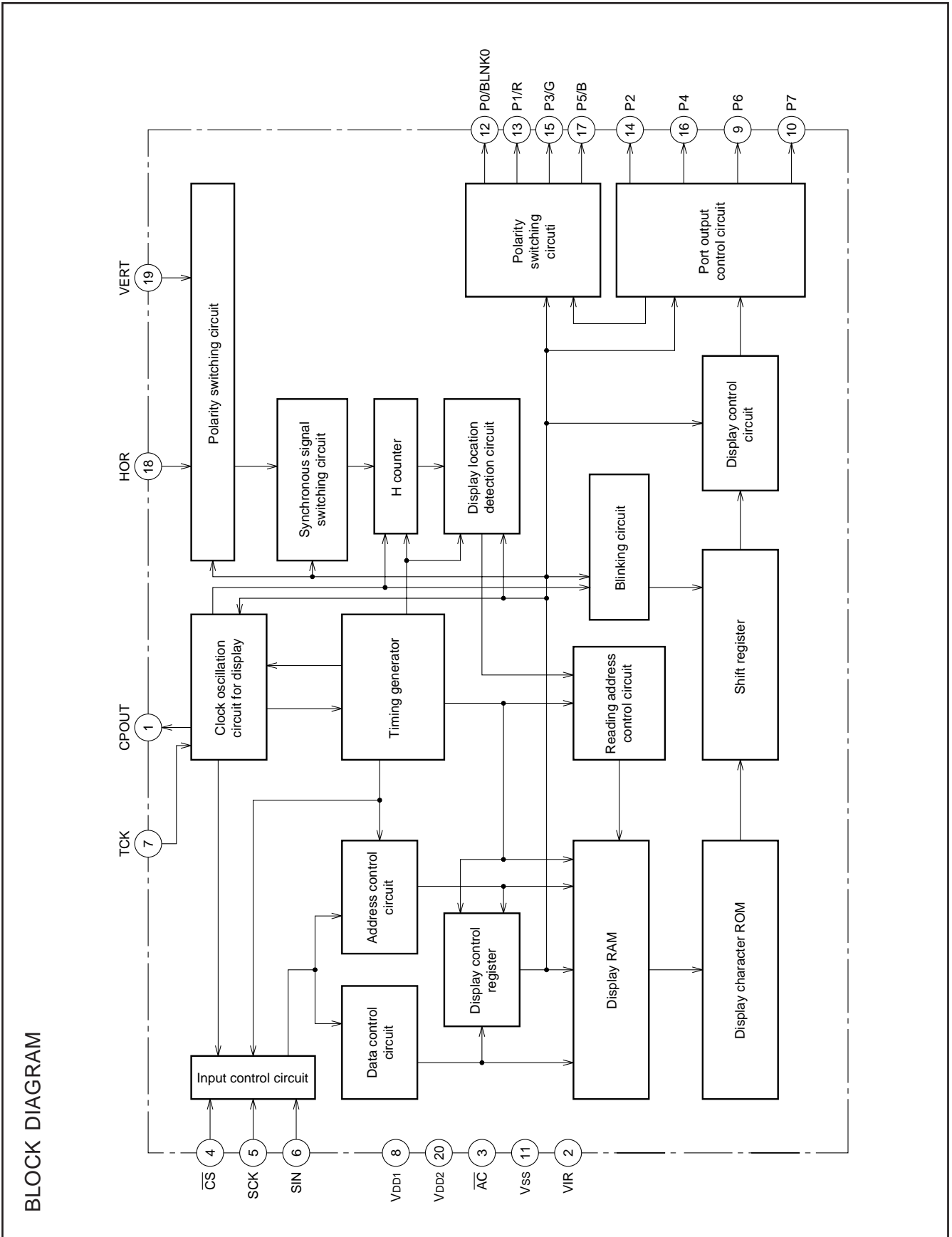

SCREEN CHARACTER and PATTERN DISPLAY CONTROLLERS

MEMORY CONSTITUTION

Address 000₁₆ to 11F₁₆ are assigned to the display RAM, address 120₁₆ to 128₁₆ are assigned to the display control registers. The internal circuit is reset and all display control registers (address 120₁₆ to 128₁₆) are set to "0" when the AC pin level is "L". And then RAM is erased.

Memory constitution is shown in Figure 1.

SCREEN CONSTITUTION

The screen lines and rows are determined from each address of the display RAM. The screen constitution is shown in Figure 2.

	DAF	DAE	DAD	DAC	DAB	DAA	DA9	DA8	DA7	DA6	DA5	DA4	DA3	DA2	DA1	DA0
000 ₁₆	0	BB	BG	BR	BLINK	B	G	R	C7	C6	C5	C4	C3	C2	C1	C0
⋮	⋮	Background coloring			Blinking	Character color			Character code							
11F ₁₆	0	BB	BG	BR	BLINK	B	G	R	C7	C6	C5	C4	C3	C2	C1	C0
120 ₁₆	0	EXCK0	VJT	DIVS1	DIVS0	DIV10	DIV9	DIV8	DIV7	DIV6	DIV5	DIV4	DIV3	DIV2	DIV1	DIV0
121 ₁₆	0	RSEL0	PTD7	PTD6	PTD5	PTD4	PTD3	PTD2	PTD1	PTD0	PTC5	PTC4	PTC3	PTC2	PTC1	PTC0
122 ₁₆	0	RSEL1	SPACE2	SPACE1	SPACE0	TEST9	HP9	HP8	HP7	HP6	HP5	HP4	HP3	HP2	HP1	HP0
123 ₁₆	0	EXCK1	TEST3	TEST2	TEST1	TEST0	VP9	VP8	VP7	VP6	VP5	VP4	VP3	VP2	VP1	VP0
124 ₁₆	0	TEST14	TEST5	TEST4	DSP11	DSP10	DSP9	DSP8	DSP7	DSP6	DSP5	DSP4	DSP3	DSP2	DSP1	DSP0
125 ₁₆	0	TEST10	VSZ1H1	VSZ1H0	VSZ1L1	VSZ1L0	V1SZ1	V1SZ0	LIN9	LIN8	LIN7	LIN6	LIN5	LIN4	LIN3	LIN2
126 ₁₆	0	TEST11	VSZ2H1	VSZ2H0	VSZ2L1	VSZ2L0	V18SZ1	V18SZ0	LIN17	LIN16	LIN15	LIN14	LIN13	LIN12	LIN11	LIN10
127 ₁₆	0	TEST12	HSZ21	HSZ20	HSZ11	HSZ10	BETA14	TEST8	TEST7	TEST6	FB	FG	FR	RB	RG	RR
128 ₁₆	0	TEST13	BLINK2	BLINK1	BLINK0	DSPON	STOP	RAMERS	SYAD	BLK1	BLK0	POLH	POLV	VMASK	B/F	BCOL

Fig. 1 Memory constitution

Row Line \	1	2	3	4	5	6	7	8	9	10	11	12	13	14	15	16	17	18	19	20	21	22	23	24
1	000 ₁₆	001 ₁₆	002 ₁₆	003 ₁₆	004 ₁₆	005 ₁₆	006 ₁₆	007 ₁₆	008 ₁₆	009 ₁₆	00A ₁₆	00B ₁₆	00C ₁₆	00D ₁₆	00E ₁₆	00F ₁₆	010 ₁₆	011 ₁₆	012 ₁₆	013 ₁₆	014 ₁₆	015 ₁₆	016 ₁₆	017 ₁₆
2	018 ₁₆	019 ₁₆	01A ₁₆	01B ₁₆	01C ₁₆	01D ₁₆	01E ₁₆	01F ₁₆	020 ₁₆	021 ₁₆	022 ₁₆	023 ₁₆	024 ₁₆	025 ₁₆	026 ₁₆	027 ₁₆	028 ₁₆	029 ₁₆	02A ₁₆	02B ₁₆	02C ₁₆	02D ₁₆	02E ₁₆	02F ₁₆
3	030 ₁₆	031 ₁₆	032 ₁₆	033 ₁₆	034 ₁₆	035 ₁₆	036 ₁₆	037 ₁₆	038 ₁₆	039 ₁₆	03A ₁₆	03B ₁₆	03C ₁₆	03D ₁₆	03E ₁₆	03F ₁₆	040 ₁₆	041 ₁₆	042 ₁₆	043 ₁₆	044 ₁₆	045 ₁₆	046 ₁₆	047 ₁₆
4	048 ₁₆	049 ₁₆	04A ₁₆	04B ₁₆	04C ₁₆	04D ₁₆	04E ₁₆	04F ₁₆	050 ₁₆	051 ₁₆	052 ₁₆	053 ₁₆	054 ₁₆	055 ₁₆	056 ₁₆	057 ₁₆	058 ₁₆	059 ₁₆	05A ₁₆	05B ₁₆	05C ₁₆	05D ₁₆	05E ₁₆	05F ₁₆
5	060 ₁₆	061 ₁₆	062 ₁₆	063 ₁₆	064 ₁₆	065 ₁₆	066 ₁₆	067 ₁₆	068 ₁₆	069 ₁₆	06A ₁₆	06B ₁₆	06C ₁₆	06D ₁₆	06E ₁₆	06F ₁₆	070 ₁₆	071 ₁₆	072 ₁₆	073 ₁₆	074 ₁₆	075 ₁₆	076 ₁₆	077 ₁₆
6	078 ₁₆	079 ₁₆	07A ₁₆	07B ₁₆	07C ₁₆	07D ₁₆	07E ₁₆	07F ₁₆	080 ₁₆	081 ₁₆	082 ₁₆	083 ₁₆	084 ₁₆	085 ₁₆	086 ₁₆	087 ₁₆	088 ₁₆	089 ₁₆	08A ₁₆	08B ₁₆	08C ₁₆	08D ₁₆	08E ₁₆	08F ₁₆
7	090 ₁₆	091 ₁₆	092 ₁₆	093 ₁₆	094 ₁₆	095 ₁₆	096 ₁₆	097 ₁₆	098 ₁₆	099 ₁₆	09A ₁₆	09B ₁₆	09C ₁₆	09D ₁₆	09E ₁₆	09F ₁₆	0A0 ₁₆	0A1 ₁₆	0A2 ₁₆	0A3 ₁₆	0A4 ₁₆	0A5 ₁₆	0A6 ₁₆	0A7 ₁₆
8	0A8 ₁₆	0A9 ₁₆	0AA ₁₆	0AB ₁₆	0AC ₁₆	0AD ₁₆	0AE ₁₆	0AF ₁₆	0B0 ₁₆	0B1 ₁₆	0B2 ₁₆	0B3 ₁₆	0B4 ₁₆	0B5 ₁₆	0B6 ₁₆	0B7 ₁₆	0B8 ₁₆	0B9 ₁₆	0BA ₁₆	0BB ₁₆	0BC ₁₆	0BD ₁₆	0BE ₁₆	0BF ₁₆
9	0C0 ₁₆	0C1 ₁₆	0C2 ₁₆	0C3 ₁₆	0C4 ₁₆	0C5 ₁₆	0C6 ₁₆	0C7 ₁₆	0C8 ₁₆	0C9 ₁₆	0CA ₁₆	0CB ₁₆	0CC ₁₆	0CD ₁₆	0CE ₁₆	0CF ₁₆	0D0 ₁₆	0D1 ₁₆	0D2 ₁₆	0D3 ₁₆	0D4 ₁₆	0D5 ₁₆	0D6 ₁₆	0D7 ₁₆
10	0D8 ₁₆	0D9 ₁₆	0DA ₁₆	0DB ₁₆	0DC ₁₆	0DD ₁₆	0DE ₁₆	0DF ₁₆	0E0 ₁₆	0E1 ₁₆	0E2 ₁₆	0E3 ₁₆	0E4 ₁₆	0E5 ₁₆	0E6 ₁₆	0E7 ₁₆	0E8 ₁₆	0E9 ₁₆	0EA ₁₆	0EB ₁₆	0EC ₁₆	0ED ₁₆	0EE ₁₆	0EF ₁₆
11	0F0 ₁₆	0F1 ₁₆	0F2 ₁₆	0F3 ₁₆	0F4 ₁₆	0F5 ₁₆	0F6 ₁₆	0F7 ₁₆	0F8 ₁₆	0F9 ₁₆	0FA ₁₆	0FB ₁₆	0FC ₁₆	0FD ₁₆	0FE ₁₆	0FF ₁₆	100 ₁₆	101 ₁₆	102 ₁₆	103 ₁₆	104 ₁₆	105 ₁₆	106 ₁₆	107 ₁₆
12	108 ₁₆	109 ₁₆	10A ₁₆	10B ₁₆	10C ₁₆	10D ₁₆	10E ₁₆	10F ₁₆	110 ₁₆	111 ₁₆	112 ₁₆	113 ₁₆	114 ₁₆	115 ₁₆	116 ₁₆	117 ₁₆	118 ₁₆	119 ₁₆	11A ₁₆	11B ₁₆	11C ₁₆	11D ₁₆	11E ₁₆	11F ₁₆

f The hexadecimal numbers in the boxes show the display RAM address.

Fig. 2 Screen constitution

REGISTERS DESCRIPTION

(1) Address 120₁₆

DA	Register	Contents		Remarks															
		Status	Function																
0	DIV0	0	Set external clock frequency value of horizontal oscillation frequency.	Set display frequency by frequency value setting. Set N1 to be "N1=fosc/fH". fosc(MHz) : External clock frequency for TCK pin (=display frequency) fH(kHz) : Horizontal synchronous signal frequency for HOR pin Set registers DIVS0, DIVS1 (address 120 ₁₆), RSEL0 (address 121 ₁₆) and RSEL1 (address 122 ₁₆) according to external clock frequency. For details, see (2) Setting display frequencies under Register Supplementary Description. Any of this settings above is required only when EXCK1=1, EXCK0=1.															
		1																	
1	DIV1	0																	
		1																	
2	DIV2	0	$N1 = \sum_{n=0}^{10} (DIVn \times 2^n)$ N1: frequency value																
		1																	
3	DIV3	0																	
		1																	
4	DIV4	0																	
		1																	
5	DIV5	0																	
		1																	
6	DIV6	0																	
		1																	
7	DIV7	0																	
		1																	
8	DIV8	0																	
		1																	
9	DIV9	0																	
		1																	
A	DIV10	0																	
		1																	
B	DIVS0	0	For details, see (2) Setting display frequencies under Register Supplementary Description.	Set display frequency area.															
		1																	
C	DIVS1	0																	
		1																	
D	VJT	0	It should be fixed to "0".																
		1	Alleviates continuous vertical jitters.																
E	EXCK0	0	<table border="1"> <thead> <tr> <th>EXCK1</th> <th>EXCK0</th> <th>Display clock input</th> </tr> </thead> <tbody> <tr> <td>0</td> <td>0</td> <td>20 to 30MHz</td> </tr> <tr> <td>0</td> <td>1</td> <td>Do not set</td> </tr> <tr> <td>1</td> <td>0</td> <td>Do not set</td> </tr> <tr> <td>1</td> <td>1</td> <td>20 to 80MHz</td> </tr> </tbody> </table>	EXCK1	EXCK0	Display clock input	0	0	20 to 30MHz	0	1	Do not set	1	0	Do not set	1	1	20 to 80MHz	See setting External Clock Input Mode (to be input from the TCK terminal). EXCK1 : address 123 ₁₆
		EXCK1	EXCK0	Display clock input															
0	0	20 to 30MHz																	
0	1	Do not set																	
1	0	Do not set																	
1	1	20 to 80MHz																	
1																			

SCREEN CHARACTER and PATTERN DISPLAY CONTROLLERS

(2) Address 121₁₆

DA	Register	Contents		Remarks
		Status	Function	
0	PTC0	0	P0 output (port P0). Port data is set by PTD0.	BLNK0 outputs blanking signal. Blanking status is determined by BLK0, BLK1, and DSP0 to DSP11 settings.
		1	BLNK0 output. Polarity is set by PTD0.	
1	PTC1	0	P1 output (port P1). Port data is set by PTD1.	
		1	R signal output. Polarity is set by PTD1.	
2	PTC2	0	P2 output (port P2). Port data is set by PTD2.	
		1	Can not be used.	
3	PTC3	0	P3 output (port P3). Port data is set by PTD3.	
		1	G signal output. Polarity is set by PTD3.	
4	PTC4	0	P4 output (port P4). Port data is set by PTD4.	
		1	Can not be used.	
5	PTC5	0	P5 output (port P5). Port data is set by PTD5.	
		1	B signal output. Polarity is set by PTD5.	
6	PTD0 (Note)	0	"L" output (P0 output) or negative polarity output (BLNK0 output).	P0 pin data control.
		1	"H" output (P0 output) or positive polarity output (BLNK0 output).	
7	PTD1 (Note)	0	"L" output (P1 output) or negative polarity output (R signal output).	P1 pin data control.
		1	"H" output (P1 output) or positive polarity output (R signal output).	
8	PTD2 (Note)	0	"L" output (P2 output).	P2 pin exclusive port output state control.
		1	"H" output (P2 output).	
9	PTD3 (Note)	0	"L" output (P3 output) or negative polarity output (G signal output).	P3 pin data control.
		1	"H" output (P3 output) or positive polarity output (G signal output).	
A	PTD4 (Note)	0	"L" output (P2 output).	P4 pin exclusive port output state control.
		1	"H" output (P2 output).	
B	PTD5 (Note)	0	"L" output (P5 output) or negative polarity output (B signal output).	P5 pin data control.
		1	"H" output (P5 output) or positive polarity output (B signal output).	
C	PTD6 (Note)	0	"L" output (P6 output).	P6 pin exclusive port output state control.
		1	"H" output (P6 output).	
D	PTD7 (Note)	0	"L" output (P7 output).	P7 pin exclusive port output state control.
		1	"H" output (P7 output).	
E	RSEL0	0	For details, see (2) Setting display frequencies under Register Supplementary Description.	Set display frequency area.
		1	To be used when EXCK0=1 and EXCK1=1.	

Note. To determined this register, input clock (at least one clock) to the external clock pin (TCK).

SCREEN CHARACTER and PATTERN DISPLAY CONTROLLERS

(3) Address 122₁₆

DA	Register	Contents		Remarks																																							
		Status	Function																																								
0	HP0 (LSB)	0	If HS is the horizontal display start location, $HS = T \times \sum_{n=0}^9 2^n HP_n + 6$	Horizontal display start location is specified using the 10 bits from HP9 to HP0. HP9 to HP0 = (0000000002) and (00000101112) setting is forbidden. Note : In case of B/ \bar{F} register is "0".																																							
		1																																									
1	HP1	0	T: The cycle of display frequency 1000 settings are possible.																																								
		1																																									
2	HP2	0																																									
		1																																									
3	HP3	0																																									
		1																																									
4	HP4	0																																									
		1																																									
5	HP5	0																																									
		1																																									
6	HP6	0																																									
		1																																									
7	HP7	0																																									
		1																																									
8	HP8	0																																									
		1																																									
9	HP9 (MSB)	0																																									
		1																																									
A	TEST9	0	It should be fixed to "0".																																								
		1	Can not be used.																																								
B	SPACE0	0	<table border="1"> <thead> <tr> <th colspan="3">SPACE</th> <th rowspan="2">Number of Lines and Space (⊕ represents space)</th> </tr> <tr> <th>2</th> <th>1</th> <th>0</th> </tr> </thead> <tbody> <tr> <td>0</td> <td>0</td> <td>0</td> <td>12</td> </tr> <tr> <td>0</td> <td>0</td> <td>1</td> <td>1 ⊕ 10 í 1</td> </tr> <tr> <td>0</td> <td>1</td> <td>0</td> <td>2 ⊕ 8 í 2</td> </tr> <tr> <td>0</td> <td>1</td> <td>1</td> <td>3 ⊕ 6 í 3</td> </tr> <tr> <td>1</td> <td>0</td> <td>0</td> <td>4 ⊕ 4 í 4</td> </tr> <tr> <td>1</td> <td>0</td> <td>1</td> <td>5 ⊕ 2 í 5</td> </tr> <tr> <td>1</td> <td>1</td> <td>0</td> <td>6 ⊕ 6</td> </tr> <tr> <td>1</td> <td>1</td> <td>1</td> <td>6 ⊕ í 6</td> </tr> </tbody> </table>	SPACE			Number of Lines and Space (⊕ represents space)	2	1	0	0	0	0	12	0	0	1	1 ⊕ 10 í 1	0	1	0	2 ⊕ 8 í 2	0	1	1	3 ⊕ 6 í 3	1	0	0	4 ⊕ 4 í 4	1	0	1	5 ⊕ 2 í 5	1	1	0	6 ⊕ 6	1	1	1	6 ⊕ í 6	Leave one line worth of space in the vertical direction. For example, 6 ⊕ 6 indicates two sets of 6 lines with a line of spaces between lines 6 and 7. A line is 18 × N horizontal scan lines. N is determined by the character size in the vertical direction as follows: ×1 ... N = 1 ×2 ... N = 2 ×3 ... N = 3 ×4 ... N = 4
		SPACE			Number of Lines and Space (⊕ represents space)																																						
2	1	0																																									
0	0	0		12																																							
0	0	1		1 ⊕ 10 í 1																																							
0	1	0		2 ⊕ 8 í 2																																							
0	1	1		3 ⊕ 6 í 3																																							
1	0	0		4 ⊕ 4 í 4																																							
1	0	1		5 ⊕ 2 í 5																																							
1	1	0		6 ⊕ 6																																							
1	1	1	6 ⊕ í 6																																								
1																																											
C	SPACE1	0																																									
		1																																									
D	SPACE2	0																																									
		1	⊕ represents one line worth of spaces.																																								
E	RSEL1	0	For details, see (2) Setting display frequencies under Register Supplementary Description. To be used when EXCK0=1 and EXCK1=1.	Set display frequency area.																																							
		1																																									

SCREEN CHARACTER and PATTERN DISPLAY CONTROLLERS

(4) Address 123₁₆

DA	Register	Contents		Remarks
		Status	Function	
0	VP0 (LSB)	0	If VS is the vertical display start location, $VS = H \times \sum_{n=0}^9 2^n VP_n$ H: Cycle with the horizontal synchronizing pulse 1023 settings are possible.	The vertical start location is specified using the 10 bits from VP9 to VP0. VP9 to VP0 = (0000000000 ₂) setting is forbidden. Note : In case of B/F register is "0".
		1		
1	VP1	0		
		1		
2	VP2	0		
		1		
3	VP3	0		
		1		
4	VP4	0		
		1		
5	VP5	0		
		1		
6	VP6	0		
		1		
7	VP7	0		
		1		
8	VP8	0		
		1		
9	VP9 (MSB)	0		
		1		
A	TEST0	0	It should be fixed to "0".	
		1	Can not be used.	
B	TEST1	0	It should be fixed to "0".	
		1	Can not be used.	
C	TEST2	0	It should be fixed to "0".	
		1	Can not be used.	
D	TEST3	0	It should be fixed to "0".	
		1	Can not be used.	
E	EXCK1	0	For setting. See Register EXCK0 (address 120 ₁₆).	Sets input mode of external clock (input from TCK pin).
		1		

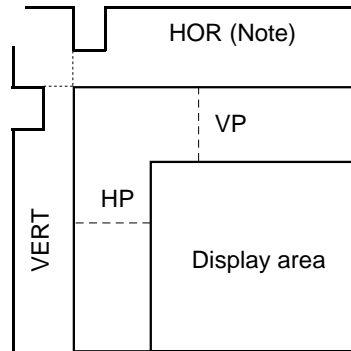

SCREEN CHARACTER and PATTERN DISPLAY CONTROLLERS

(5) Address 124₁₆

DA	Register	Contents		Remarks
		Status	Function	
0	DSP0	0	Blanking is in the display mode specified by BLK0 and BLK1. (Note)	Sets the display mode of line 1.
		1	Blanking is in the display mode specified by except BLK0 and BLK1. (Note)	
1	DSP1	0	Blanking is in the display mode specified by BLK0 and BLK1. (Note)	Sets the display mode of line 2.
		1	Blanking is in the display mode specified by except BLK0 and BLK1. (Note)	
2	DSP2	0	Blanking is in the display mode specified by BLK0 and BLK1. (Note)	Sets the display mode of line 3.
		1	Blanking is in the display mode specified by except BLK0 and BLK1. (Note)	
3	DSP3	0	Blanking is in the display mode specified by BLK0 and BLK1. (Note)	Sets the display mode of line 4.
		1	Blanking is in the display mode specified by except BLK0 and BLK1. (Note)	
4	DSP4	0	Blanking is in the display mode specified by BLK0 and BLK1. (Note)	Sets the display mode of line 5.
		1	Blanking is in the display mode specified by except BLK0 and BLK1. (Note)	
5	DSP5	0	Blanking is in the display mode specified by BLK0 and BLK1. (Note)	Sets the display mode of line 6.
		1	Blanking is in the display mode specified by except BLK0 and BLK1. (Note)	
6	DSP6	0	Blanking is in the display mode specified by BLK0 and BLK1. (Note)	Sets the display mode of line 7.
		1	Blanking is in the display mode specified by except BLK0 and BLK1. (Note)	
7	DSP7	0	Blanking is in the display mode specified by BLK0 and BLK1. (Note)	Sets the display mode of line 8.
		1	Blanking is in the display mode specified by except BLK0 and BLK1. (Note)	
8	DSP8	0	Blanking is in the display mode specified by BLK0 and BLK1. (Note)	Sets the display mode of line 9.
		1	Blanking is in the display mode specified by except BLK0 and BLK1. (Note)	
9	DSP9	0	Blanking is in the display mode specified by BLK0 and BLK1. (Note)	Sets the display mode of line 10.
		1	Blanking is in the display mode specified by except BLK0 and BLK1. (Note)	
A	DSP10	0	Blanking is in the display mode specified by BLK0 and BLK1. (Note)	Sets the display mode of line 11.
		1	Blanking is in the display mode specified by except BLK0 and BLK1. (Note)	
B	DSP11	0	Blanking is in the display mode specified by BLK0 and BLK1. (Note)	Sets the display mode of line 12.
		1	Blanking is in the display mode specified by except BLK0 and BLK1. (Note)	
C	TEST4	0	It should be fixed to "0".	
		1	Can not be used.	
D	TEST5	0	It should be fixed to "0".	
		1	Can not be used.	
E	TEST14	0	Can not be used.	
		1	It should be fixed to "1".	

Note: Refer to DISPLAY FORM1.

SCREEN CHARACTER and PATTERN DISPLAY CONTROLLERS

(6) Address 125₁₆

DA	Register	Contents		Remarks												
		Status	Function													
0	LIN2	0	The first line is set by VSZ1L0 and VSZ1L1. The second to 12th lines are set by VSZ2L0 and VSZ2L1.	Character size setting in the vertical direction for the 2nd line.												
		1	The first line is set by VSZ1H0 and VSZ1H1. The second to 12th lines are set by VSZ2H0 and VSZ2H1.													
1	LIN3	0	The first line is set by VSZ1L0 and VSZ1L1. The second to 12th lines are set by VSZ2L0 and VSZ2L1.	Character size setting in the vertical direction for the 3rd line.												
		1	The first line is set by VSZ1H0 and VSZ1H1. The second to 12th lines are set by VSZ2H0 and VSZ2H1.													
2	LIN4	0	The first line is set by VSZ1L0 and VSZ1L1. The second to 12th lines are set by VSZ2L0 and VSZ2L1.	Character size setting in the vertical direction for the 4th line.												
		1	The first line is set by VSZ1H0 and VSZ1H1. The second to 12th lines are set by VSZ2H0 and VSZ2H1.													
3	LIN5	0	The first line is set by VSZ1L0 and VSZ1L1. The second to 12th lines are set by VSZ2L0 and VSZ2L1.	Character size setting in the vertical direction for the 5th line.												
		1	The first line is set by VSZ1H0 and VSZ1H1. The second to 12th lines are set by VSZ2H0 and VSZ2H1.													
4	LIN6	0	The first line is set by VSZ1L0 and VSZ1L1. The second to 12th lines are set by VSZ2L0 and VSZ2L1.	Character size setting in the vertical direction for the 6th line.												
		1	The first line is set by VSZ1H0 and VSZ1H1. The second to 12th lines are set by VSZ2H0 and VSZ2H1.													
5	LIN7	0	The first line is set by VSZ1L0 and VSZ1L1. The second to 12th lines are set by VSZ2L0 and VSZ2L1.	Character size setting in the vertical direction for the 7th line.												
		1	The first line is set by VSZ1H0 and VSZ1H1. The second to 12th lines are set by VSZ2H0 and VSZ2H1.													
6	LIN8	0	The first line is set by VSZ1L0 and VSZ1L1. The second to 12th lines are set by VSZ2L0 and VSZ2L1.	Character size setting in the vertical direction for the 8th line.												
		1	The first line is set by VSZ1H0 and VSZ1H1. The second to 12th lines are set by VSZ2H0 and VSZ2H1.													
7	LIN9	0	The first line is set by VSZ1L0 and VSZ1L1. The second to 12th lines are set by VSZ2L0 and VSZ2L1.	Character size setting in the vertical direction for the 9th line.												
		1	The first line is set by VSZ1H0 and VSZ1H1. The second to 12th lines are set by VSZ2H0 and VSZ2H1.													
8	V1SZ0	0	H: Cycle with the horizontal synchronizing pulse	Character size setting in the vertical direction for the 1st line. (display monitor 1 to 12 line)												
		1	<table border="1"> <thead> <tr> <th>V1SZ1</th> <th>V1SZ0</th> <th>Vertical direction size</th> </tr> </thead> <tbody> <tr> <td>0</td> <td>0</td> <td>1H/dot</td> </tr> <tr> <td>0</td> <td>1</td> <td>2H/dot</td> </tr> <tr> <td>1</td> <td>0</td> <td>3H/dot</td> </tr> <tr> <td>1</td> <td>1</td> <td>4H/dot</td> </tr> </tbody> </table>		V1SZ1	V1SZ0	Vertical direction size	0	0	1H/dot	0	1	2H/dot	1	0	3H/dot
V1SZ1	V1SZ0	Vertical direction size														
0	0	1H/dot														
0	1	2H/dot														
1	0	3H/dot														
1	1	4H/dot														
9	V1SZ1	0														
		1														
A	VSZ1L0	0	H: Cycle with the horizontal synchronizing pulse	Character size setting in the vertical direction (display monitor 1 line) at "0" state in register LIN2 to LIN17.												
		1	<table border="1"> <thead> <tr> <th>VSZ1L1</th> <th>VSZ1L0</th> <th>Vertical direction size</th> </tr> </thead> <tbody> <tr> <td>0</td> <td>0</td> <td>1H/dot</td> </tr> <tr> <td>0</td> <td>1</td> <td>2H/dot</td> </tr> <tr> <td>1</td> <td>0</td> <td>3H/dot</td> </tr> <tr> <td>1</td> <td>1</td> <td>4H/dot</td> </tr> </tbody> </table>		VSZ1L1	VSZ1L0	Vertical direction size	0	0	1H/dot	0	1	2H/dot	1	0	3H/dot
VSZ1L1	VSZ1L0	Vertical direction size														
0	0	1H/dot														
0	1	2H/dot														
1	0	3H/dot														
1	1	4H/dot														
B	VSZ1L1	0														
		1														
C	VSZ1H0	0	H: Cycle with the horizontal synchronizing pulse	Character size setting in the vertical direction (display monitor 1 line) at "1" state in register LIN2 to LIN17.												
		1	<table border="1"> <thead> <tr> <th>VSZ1H1</th> <th>VSZ1H0</th> <th>Vertical direction size</th> </tr> </thead> <tbody> <tr> <td>0</td> <td>0</td> <td>1H/dot</td> </tr> <tr> <td>0</td> <td>1</td> <td>2H/dot</td> </tr> <tr> <td>1</td> <td>0</td> <td>3H/dot</td> </tr> <tr> <td>1</td> <td>1</td> <td>4H/dot</td> </tr> </tbody> </table>		VSZ1H1	VSZ1H0	Vertical direction size	0	0	1H/dot	0	1	2H/dot	1	0	3H/dot
VSZ1H1	VSZ1H0	Vertical direction size														
0	0	1H/dot														
0	1	2H/dot														
1	0	3H/dot														
1	1	4H/dot														
D	VSZ1H1	0														
		1														
E	TEST10	0	It should be fixed to "0".													
		1	Test mode													

SCREEN CHARACTER and PATTERN DISPLAY CONTROLLERS

(7) Address 126₁₆

DA	Register	Contents		Remarks												
		Status	Function													
0	LIN10	0	The first line is set by VSZ1L0 and VSZ1L1. The second to 12th lines are set by VSZ2L0 and VSZ2L1.	Character size setting in the vertical direction for the 10th line.												
		1	The first line is set by VSZ1H0 and VSZ1H1. The second to 12th lines are set by VSZ2H0 and VSZ2H1.													
1	LIN11	0	The first line is set by VSZ1L0 and VSZ1L1. The second to 12th lines are set by VSZ2L0 and VSZ2L1.	Character size setting in the vertical direction for the 11th line.												
		1	The first line is set by VSZ1H0 and VSZ1H1. The second to 12th lines are set by VSZ2H0 and VSZ2H1.													
2	LIN12	0	The first line is set by VSZ1L0 and VSZ1L1. The second to 12th lines are set by VSZ2L0 and VSZ2L1.	Character size setting in the vertical direction for the 12th line.												
		1	The first line is set by VSZ1H0 and VSZ1H1. The second to 12th lines are set by VSZ2H0 and VSZ2H1.													
3	LIN13	0	The first line is set by VSZ1L0 and VSZ1L1. The second to 12th lines are set by VSZ2L0 and VSZ2L1.	Character size setting in the vertical direction for the 13th line.												
		1	The first line is set by VSZ1H0 and VSZ1H1. The second to 12th lines are set by VSZ2H0 and VSZ2H1.													
4	LIN14	0	The first line is set by VSZ1L0 and VSZ1L1. The second to 12th lines are set by VSZ2L0 and VSZ2L1.	Character size setting in the vertical direction for the 14th line.												
		1	The first line is set by VSZ1H0 and VSZ1H1. The second to 12th lines are set by VSZ2H0 and VSZ2H1.													
5	LIN15	0	The first line is set by VSZ1L0 and VSZ1L1. The second to 12th lines are set by VSZ2L0 and VSZ2L1.	Character size setting in the vertical direction for the 15th line.												
		1	The first line is set by VSZ1H0 and VSZ1H1. The second to 12th lines are set by VSZ2H0 and VSZ2H1.													
6	LIN16	0	The first line is set by VSZ1L0 and VSZ1L1. The second to 12th lines are set by VSZ2L0 and VSZ2L1.	Character size setting in the vertical direction for the 16th line.												
		1	The first line is set by VSZ1H0 and VSZ1H1. The second to 12th lines are set by VSZ2H0 and VSZ2H1.													
7	LIN17	0	The first line is set by VSZ1L0 and VSZ1L1. The second to 12th lines are set by VSZ2L0 and VSZ2L1.	Character size setting in the vertical direction for the 17th line.												
		1	The first line is set by VSZ1H0 and VSZ1H1. The second to 12th lines are set by VSZ2H0 and VSZ2H1.													
8	V18SZ0	0	H: Cycle with the horizontal synchronizing pulse	Character size setting in the vertical direction for the 18th line. (display monitor 1 to 12 line)												
		1	<table border="1"> <thead> <tr> <th>V18SZ1</th> <th>V18SZ0</th> <th>Vertical direction size</th> </tr> </thead> <tbody> <tr> <td>0</td> <td>0</td> <td>1H/dot</td> </tr> <tr> <td>0</td> <td>1</td> <td>2H/dot</td> </tr> <tr> <td>1</td> <td>0</td> <td>3H/dot</td> </tr> <tr> <td>1</td> <td>1</td> <td>4H/dot</td> </tr> </tbody> </table>		V18SZ1	V18SZ0	Vertical direction size	0	0	1H/dot	0	1	2H/dot	1	0	3H/dot
V18SZ1	V18SZ0	Vertical direction size														
0	0	1H/dot														
0	1	2H/dot														
1	0	3H/dot														
1	1	4H/dot														
9	V18SZ1	0														
		1														
A	VSZ2L0	0	H: Cycle with the horizontal synchronizing pulse	Character size setting in the vertical direction (display monitor for 2 to 12 line) at "0" state in register LIN2 to LIN17.												
		1	<table border="1"> <thead> <tr> <th>VSZ2L1</th> <th>VSZ2L0</th> <th>Vertical direction size</th> </tr> </thead> <tbody> <tr> <td>0</td> <td>0</td> <td>1H/dot</td> </tr> <tr> <td>0</td> <td>1</td> <td>2H/dot</td> </tr> <tr> <td>1</td> <td>0</td> <td>3H/dot</td> </tr> <tr> <td>1</td> <td>1</td> <td>4H/dot</td> </tr> </tbody> </table>		VSZ2L1	VSZ2L0	Vertical direction size	0	0	1H/dot	0	1	2H/dot	1	0	3H/dot
VSZ2L1	VSZ2L0	Vertical direction size														
0	0	1H/dot														
0	1	2H/dot														
1	0	3H/dot														
1	1	4H/dot														
B	VSZ2L1	0														
		1														
C	VSZ2H0	0	H: Cycle with the horizontal synchronizing pulse	Character size setting in the vertical direction (display monitor for 2 to 12 line) at "1" state in register LIN2 to LIN17.												
		1	<table border="1"> <thead> <tr> <th>VSZ2H1</th> <th>VSZ2H0</th> <th>Vertical direction size</th> </tr> </thead> <tbody> <tr> <td>0</td> <td>0</td> <td>1H/dot</td> </tr> <tr> <td>0</td> <td>1</td> <td>2H/dot</td> </tr> <tr> <td>1</td> <td>0</td> <td>3H/dot</td> </tr> <tr> <td>1</td> <td>1</td> <td>4H/dot</td> </tr> </tbody> </table>		VSZ2H1	VSZ2H0	Vertical direction size	0	0	1H/dot	0	1	2H/dot	1	0	3H/dot
VSZ2H1	VSZ2H0	Vertical direction size														
0	0	1H/dot														
0	1	2H/dot														
1	0	3H/dot														
1	1	4H/dot														
D	VSZ2H1	0														
		1														
E	TEST11	0	It should be fixed to "0".													
		1	Test mode													

SCREEN CHARACTER and PATTERN DISPLAY CONTROLLERS

(8) Address 127₁₆

DA	Register	Contents				Remarks	
		Status	Function				
0	RR	0	RB	RG	RR	Color	Sets the color of all blankings.
		1	0	0	0	Black	
1	RG	0	0	0	1	Red	
		1	0	1	0	Green	
2	RB	0	0	1	1	Yellow	
		1	1	0	0	Blue	
3	FR	0	1	0	1	Magenta	
		1	1	1	0	Cyan	
4	FG	0	1	1	1	White	
		1					
5	FB	0					
		1					
6	TEST6	0	It should be fixed to "0".				
		1	Can not be used.				
7	TEST7	0	It should be fixed to "0".				
		1	Can not be used.				
8	TEST8	0	It should be fixed to "0".				
		1	Can not be used.				
9	BETA14	0	Matrix-outline display (12 × 18 dot)			Set this register to the character font set by display RAM BR, BG and BB.	
		1	Matrix-outline display (14 × 18 dot)				
A	HSZ10	0	T: Display frequency cycle			Character size setting in the horizontal direction for the first line.	
		1	HSZ11	HSZ10	Horizontal direction size		
B	HSZ11	0	0	0	1T/dot		
		1	0	1	2T/dot		
C	HSZ20	0	1	0	3T/dot		
		1	1	1	4T/dot		
D	HSZ21	0	0	0	1T/dot		
		1	0	1	2T/dot		
E	TEST12	0	It should be fixed to "0".				
		1	Test mode				

SCREEN CHARACTER and PATTERN DISPLAY CONTROLLERS

(9) Address 128₁₆

DA	Register	Contents		Remarks																		
		Status	Function																			
0	BCOL	0	Blanking of BLK0, BLK1	Sets all raster blanking																		
		1	All raster blanking																			
1	B/F	0	Synchronize with the leading edge of horizontal synchronization.	Synchronize with the front porch or back porch of the horizontal synchronazation signal.																		
		1	Synchronize with the trailing edge of horizontal synchronization.																			
2	VMASK	0	Do not mask by VERT input signal	This register has or do not have mask at phase comparison operating.																		
		1	Mask by VERT input signal																			
3	POLV	0	VERT pin is negative polarity	Set VERT pin polarity.																		
		1	VERT pin is positive polarity																			
4	POLH	0	HOR pin is negative polarity	Set HOR pin polarity.																		
		1	HOR pin is positive polarity																			
5	BLK0	0	<table border="1"> <thead> <tr> <th colspan="2">BLK</th> <th rowspan="2">Blanking mode</th> </tr> </thead> <tbody> <tr> <td>1</td> <td>0</td> <td></td> </tr> <tr> <td>0</td> <td>0</td> <td>Matrix-outline size</td> </tr> <tr> <td>0</td> <td>1</td> <td>Character size</td> </tr> <tr> <td>1</td> <td>0</td> <td>Border size</td> </tr> <tr> <td>1</td> <td>1</td> <td>Matrix-outline size</td> </tr> </tbody> </table>	BLK		Blanking mode	1	0		0	0	Matrix-outline size	0	1	Character size	1	0	Border size	1	1	Matrix-outline size	Set blanking mode. (Note 1) An example of blanking mode at BCOL = "0", DSPn = "0" (n = 0 to 11) shown left.
		BLK		Blanking mode																		
1	0																					
0	0	Matrix-outline size																				
0	1	Character size																				
1	0	Border size																				
1	1	Matrix-outline size																				
1																						
6	BLK1	0																				
		1																				
7	SYAD	0	Border display of character	(Note 2)																		
		1	Shadow display of character																			
8	RAMERS	0	RAM not erased	There is no need to reset because there is no register for this bit.																		
		1	RAM erased																			
9	STOP	0	Oscillation of clock for display	R, G, B and BLNK0 output can be altered.																		
		1	Stop the oscillation of clock for display																			
A	DSPON	0	Display OFF	Display can be altered.																		
		1	Display ON																			
B	BLINK0	0	<table border="1"> <thead> <tr> <th colspan="2">BLINK</th> <th rowspan="2">Duty</th> </tr> </thead> <tbody> <tr> <td>1</td> <td>0</td> <td></td> </tr> <tr> <td>0</td> <td>0</td> <td>Blinking OFF</td> </tr> <tr> <td>0</td> <td>1</td> <td>25%</td> </tr> <tr> <td>1</td> <td>0</td> <td>50%</td> </tr> <tr> <td>1</td> <td>1</td> <td>75%</td> </tr> </tbody> </table>	BLINK		Duty	1	0		0	0	Blinking OFF	0	1	25%	1	0	50%	1	1	75%	Blinking duty ratio can be altered.
		BLINK		Duty																		
1	0																					
0	0	Blinking OFF																				
0	1	25%																				
1	0	50%																				
1	1	75%																				
1																						
C	BLINK1	0																				
		1																				
D	BLINK2	0	Divided into 64 of vertical synchronous signal	Blinking frequency can be altered.																		
		1	Divided into 32 of vertical synchronous signal																			
E	TEST13	0	It should be fixed to "0".																			
		1	Test mode																			

Notes 1: Refer to DISPLAY FORM 1 2: Refer to DISPLAY FORM 3

REGISTER SUPPLEMENTARY DESCRIPTION

(1) Setting external clock input mode (by use of EXCK0 (120₁₆) and EXCK1 (123₁₆))

Two modes given below are available for the external clock signal input. (the settings (EXCK1, EXCK0) = (0, 1), (1, 0) are forbidden.)

(a) When (EXCK1, EXCK0) = (0, 0), Fosc = 20 to 30 MHz

Input from the TCK pin a constant-period continuous external clock that synchronizes with the horizontal synchronization signal. And input from HOR pin a constant-period continuous horizontal synchronous signal.

Never stop inputting the clock while displaying.

Do not have to set a display frequency because the clock just as it is entered from outside is used as the display clock.

(b) When (EXCK1, EXCK0) = (1, 1), Fosc = 20 to 80 MHz

Input from the TCK pin a constant-period continuous external clock that synchronizes with the horizontal synchronization signal.

Never stop inputting the clock while displaying.

Be sure to set a display frequency because the internal clock made to synchronize with the clock input from outside is used as the display clock (see the next page).

(Example for input)

Horizontal synchronous signal

External clock

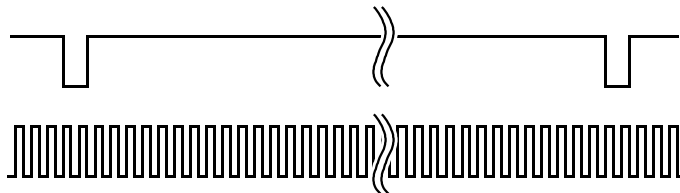

SCREEN CHARACTER and PATTERN DISPLAY CONTROLLERS

(2) Setting display frequencies

Set a display frequency by setting a frequency value for the horizontal synchronization signal by use of DIV10 to DIV0 (120₁₆).

Set display frequency area in conformity with the frequency of the external clock signal.

Set display frequency area by use of DIVS0, DIVS1 (120₁₆), RSEL0 (121₁₆), and RSEL1 (122₁₆). Frequency area are as follows.

RSEL1	RSEL0	DIVS1	DIVS0	Display frequency area
0	1	0	0	70.0 to 80.0
0	0	0	0	63.0 to 70.0
1	0	0	1	56.6 to 63.0
0	1	0	1	46.6 to 56.6
0	0	0	1	45.0 to 46.6
1	0	1	0	42.5 to 45.0
0	1	1	0	35.0 to 42.5
0	0	1	0	31.5 to 35.0
1	0	1	1	28.3 to 31.5
0	1	1	1	23.3 to 28.3
0	0	1	1	20.0 to 23.3

Cautions in setting a display frequency

To change the external clock frequency or the horizontal synchronization frequency, follow the steps in sequence given below.

- (a) Display OFF (DSPON = 0)
- (b) Set the display frequency (Use DIV10 to DIV0 (120₁₆), DIVS0, DIVS1 (120₁₆), RSEL0 (121₁₆), and RSEL1 (122₁₆).
- (c) 20-ms waiting time with the horizontal synchronization signal and the external clock signal being input
- (d) Display ON (DSPON = 1)

SCREEN CHARACTER and PATTERN DISPLAY CONTROLLERS

DISPLAY FORM1

Table 1 shows display form of blanking.

Table 1. Display mode

BCOL	Standard blanking		When the all of registers DSPn (Note 2) are set to "0"	When some of registers DSPn are set to "1"		BLNK0 output
	BLK1	BLK0		DSPn = 0	DSPn = 1	
0	0	0	Matrix-outline and border display. color set: FR, FG, FB or display RAM (Note 4)	Matrix-outline and border display. color set: FR, FG, FB or display RAM (Note 4)	Matrix-outline display color set: display RAM (Note 3)	DSPn = "0" line } DSPn = "1" line } Matrix-outline size
	0	1	Character	Character	Border display color set: display RAM (Note 3)	DSPn = "0" line → Character size DSPn = "1" line → Border size
	1	0	Border display color set: display RAM (Note 3)	Border display color set: display RAM (Note 3)	Matrix-outline display color set: display RAM (Note 3)	DSPn = "0" line → Border size DSPn = "1" line → Matrix-outline size
	1	1	Matrix-outline display color set: display RAM (Note 3)	Matrix-outline display color set: display RAM (Note 3)	Character	DSPn = "0" line → Matrix-outline size DSPn = "1" line → Character size
1 (Note 1)	0	0	Matrix-outline and border display. color set: FR, FG, FB or display RAM (Note 4)	Matrix-outline and border display. color set: FR, FG, FB or display RAM (Note 4)	Matrix-outline display color set: display RAM (Note 3)	All blanking size
	0	1	Character	Character	Border display color set: display RAM (Note 3)	
	1	0	Border display color set: display RAM (Note 3)	Border display color set: display RAM (Note 3)	Matrix-outline display color set: display RAM (Note 3)	
	1	1	Matrix-outline display color set: display RAM (Note 3)	Matrix-outline display color set: display RAM (Note 3)	Character	

Notes 1: Color setting of raster area is set by register RR, RG and RB.

2: DSPn (n = 0 to 11)

3: Set by BR, BG and BB of display RAM.

4: Set border by register FR, FG and FB. Set matrix-outline by BR, BG and BB of display RAM.

DISPLAY FORM 2

M35046-XXXSP/FP has the following four display forms.

- (1) Character size
: Blanking same as the character size.
- (2) Border size
: Blanking the background as a size from character.
- (3) Matrix-outline size
: Blanking the background 12 × 18 dot.
When set register BETA14 to "1", setting of blanking the background 14 × 18 dot is possible.
- (4) All blanking size
: When set register BCOL to "1", all raster area is blanking.

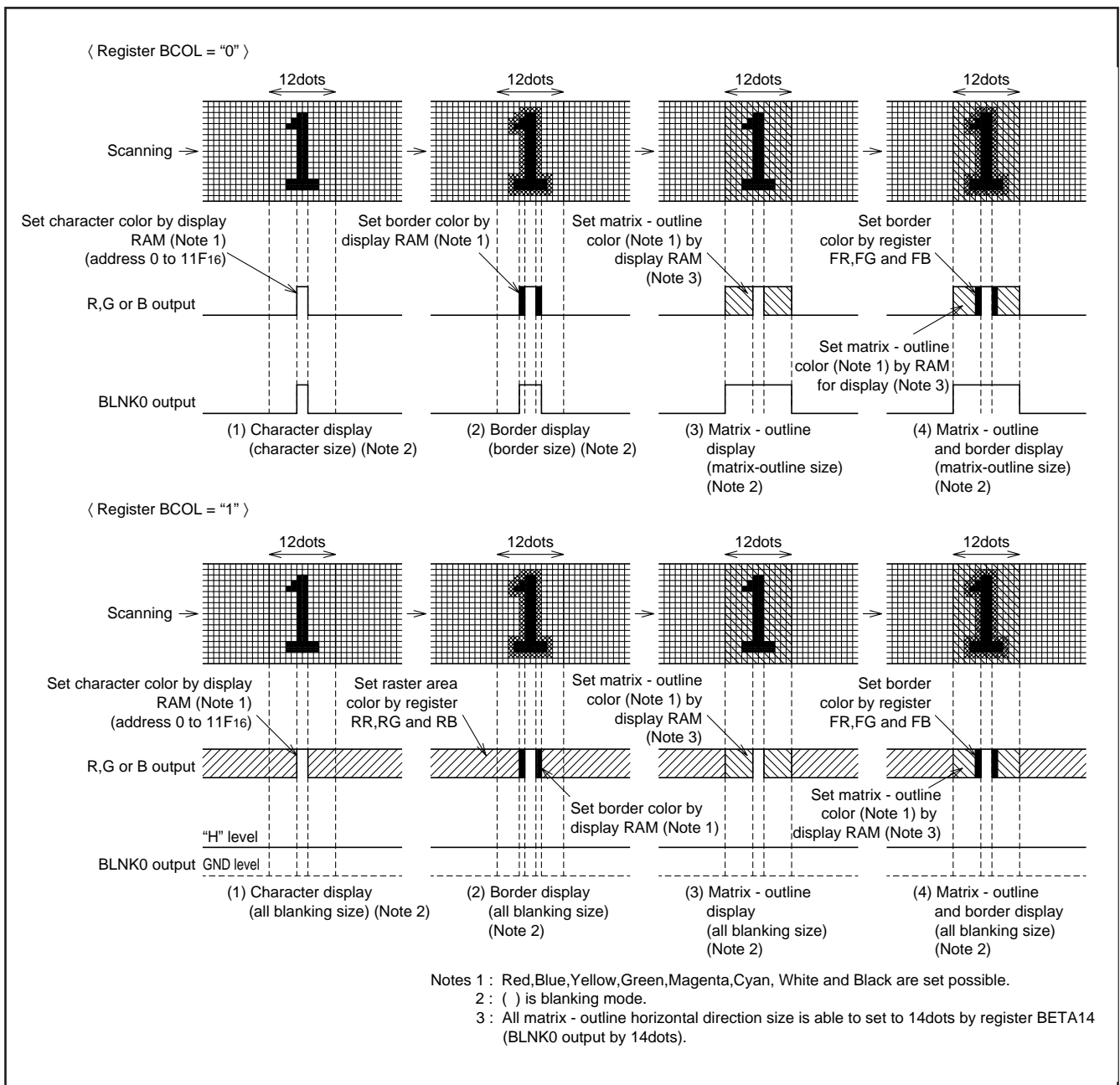

Fig. 3 Display form

DISPLAY FORM 3

When border display mode, if set SYAD = "0" to "1", it change to shadow display mode.

Border and shadow display are shown below.

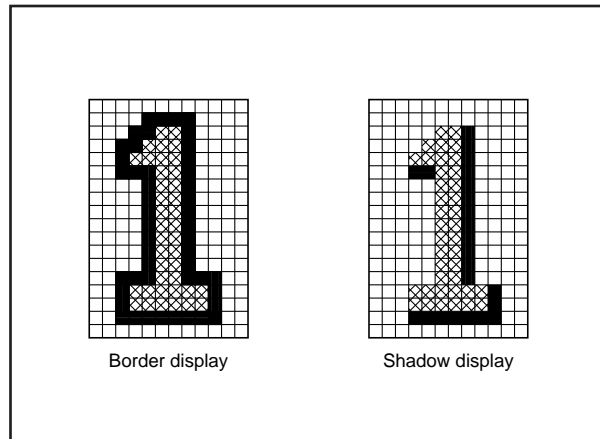

Fig. 4 Border and shadow display

Set shadow display color by display RAM or register FR, FG and FB.

DATA INPUT EXAMPLE

Data of display RAM and display control registers can be set by the serial input function. Example of data setting is shown in Figure 5 and Figure 6.

(1) At EXCK0 = "0", EXCK1 = "0" setting

		DAF	DAE	DAD	DAC	DAB	DAA	DA9	DA8	DA7	DA6	DA5	DA4	DA3	DA2	DA1	DA0	Addition
		200 msec hold																System set-up
1	address 120 ₁₆	0	0	0	0	0	0	0	1	0	0	1	0	0	0	0	0	Address set
2	data 120 ₁₆	0	0	1	0	0	0	0	0	0	0	0	0	0	0	0	0	(Note 1)
3	data 121 ₁₆	0	0	PTD7	PTD6	1	PTD4	1	PTD2	1	1	1	0	1	0	1	1	Output setting
4	data 122 ₁₆	0	0	0	0	0	0	HP9	HP8	HP7	HP6	HP5	HP4	HP3	HP2	HP1	HP0	Horizontal display location setting
5	data 123 ₁₆	0	0	0	0	0	0	VP9	VP8	VP7	VP6	VP5	VP4	VP3	VP2	VP1	VP0	Vertical display location setting
6	data 124 ₁₆	0	0	0	0	0	0	0	0	0	0	0	0	0	0	0	0	Display form setting
7	data 125 ₁₆	0	0	0	0	0	0	0	0	0	0	0	0	0	0	0	0	Character size setting
8	data 126 ₁₆	0	0	0	0	0	0	0	0	0	0	0	0	0	0	0	0	Character size setting
9	data 127 ₁₆	0	0	0	0	0	0	0	0	0	0	0	0	0	0	0	0	Color, character size setting
10	data 128 ₁₆	0	0	0	0	0	0	0	1	0	1	1	POLH	POLV	0	0	0	Display OFF, display form (Note 2)
11	data 000 ₁₆	0	BB	BG	BR	BLINK	B	G	R	C7	C6	C5	C4	C3	C2	C1	C0	
12 ⋮ ⋮ ⋮ 297	⋮ ⋮ ⋮ ⋮ ⋮	⋮ ⋮ ⋮ ⋮ ⋮	Character background color			Blinking	Character color			Character code								Character setting
298	data 11F ₁₆	0	BB	BG	BR	BLINK	B	G	R	C7	C6	C5	C4	C3	C2	C1	C0	
299	address 128 ₁₆	0	0	0	0	0	0	0	1	0	0	1	0	1	0	0	0	Address setting
300	data 128 ₁₆	0	0	0	0	0	1	0	0	0	1	1	POLH	POLV	0	0	0	Display ON, display form (Note 2)

Notes 1 : Input the horizontal synchronous signal to the HOR pin and the vertical synchronous signal to the VERT pin. If serrated pulses are present in the vertical synchronous signal, set the register VMASK to 1.
 2 : Matrix-outline display in this data.

Fig. 5 Example of data setting by the serial input function (1)

SCREEN CHARACTER and PATTERN DISPLAY CONTROLLERS

(2) At EXCK0 = "1", EXCK1 = "1" setting

		DAF	DAE	DAD	DAC	DAB	DAA	DA9	DA8	DA7	DA6	DA5	DA4	DA3	DA2	DA1	DA0	Addition
		200 msec hold																System set-up
1	address 120 ₁₆	0	0	0	0	0	0	0	1	0	0	1	0	0	0	0	0	Address set
2	data 120 ₁₆	0	1	1	DIVS1	DIVS0	DIV10	DIV9	DIV8	DIV7	DIV6	DIV5	DIV4	DIV3	DIV2	DIV1	DIV0	Set frequency value of horizontal synchronous frequency(Note 1)
3	data 121 ₁₆	0	RSEL0	PTD7	PTD6	1	PTD4	1	PTD2	1	1	1	0	1	0	1	1	Output setting Oscillation circuit setting
4	data 122 ₁₆	0	RSEL1	0	0	0	0	HP9	HP8	HP7	HP6	HP5	HP4	HP3	HP2	HP1	HP0	Horizontal display location setting Oscillation circuit setting
5	data 123 ₁₆	0	1	0	0	0	0	VP9	VP8	VP7	VP6	VP5	VP4	VP3	VP2	VP1	VP0	Vertical display location setting
6	data 124 ₁₆	0	1	0	0	0	0	0	0	0	0	0	0	0	0	0	0	Display form setting
7	data 125 ₁₆	0	0	0	0	0	0	0	0	0	0	0	0	0	0	0	0	Character size setting
8	data 126 ₁₆	0	0	0	0	0	0	0	0	0	0	0	0	0	0	0	0	Character size setting
9	data 127 ₁₆	0	0	0	0	0	0	0	0	0	0	0	0	0	0	0	0	Color, character size setting
10	data 128 ₁₆	0	0	0	0	0	0	0	1	0	1	1	POLH	POLV	0	0	0	Display OFF, display form (Note 2)
		Hold the time length as 1V of vertical synchronous signal																
11	data 000 ₁₆	0	BB	BG	BR	BLINK	B	G	R	C7	C6	C5	C4	C3	C2	C1	C0	Character setting
12	⋮	⋮	Character background color			BLINK-ING	Character color			Character code								
⋮	⋮	⋮																
297	⋮	⋮																
298	data 11F ₁₆	0	BB	BG	BR	BLINK	B	G	R	C7	C6	C5	C4	C3	C2	C1	C0	
299	address 128 ₁₆	0	0	0	0	0	0	0	1	0	0	1	0	1	0	0	0	Address setting
300	data 128 ₁₆	0	0	0	0	0	1	0	0	0	1	1	POLH	POLV	0	0	0	Display ON, display form (Note 2)

Notes 1 : From this time, input clock to TCK pin. And, input the horizontal synchronous signal to the HOR pin and the vertical synchronous signal to the VERT pin. If serrated pulses are present in the vertical synchronous signal, set the register VMASK to 1.
2 : Matrix-outline display in this data.

Fig. 6 Example of data setting by the serial input function (2)

SERIAL DATA INPUT TIMING

- (1) Serial data should be input with the LSB first.
- (2) The address consists of 16 bits.
- (3) The data consists of 16 bits.
- (4) The 16 bits in the SCK after the \overline{CS} signal has fallen are the address, and for succeeding input data, the address is incremented every 16 bits. Therefore, it is not necessary to input the address from the second data.

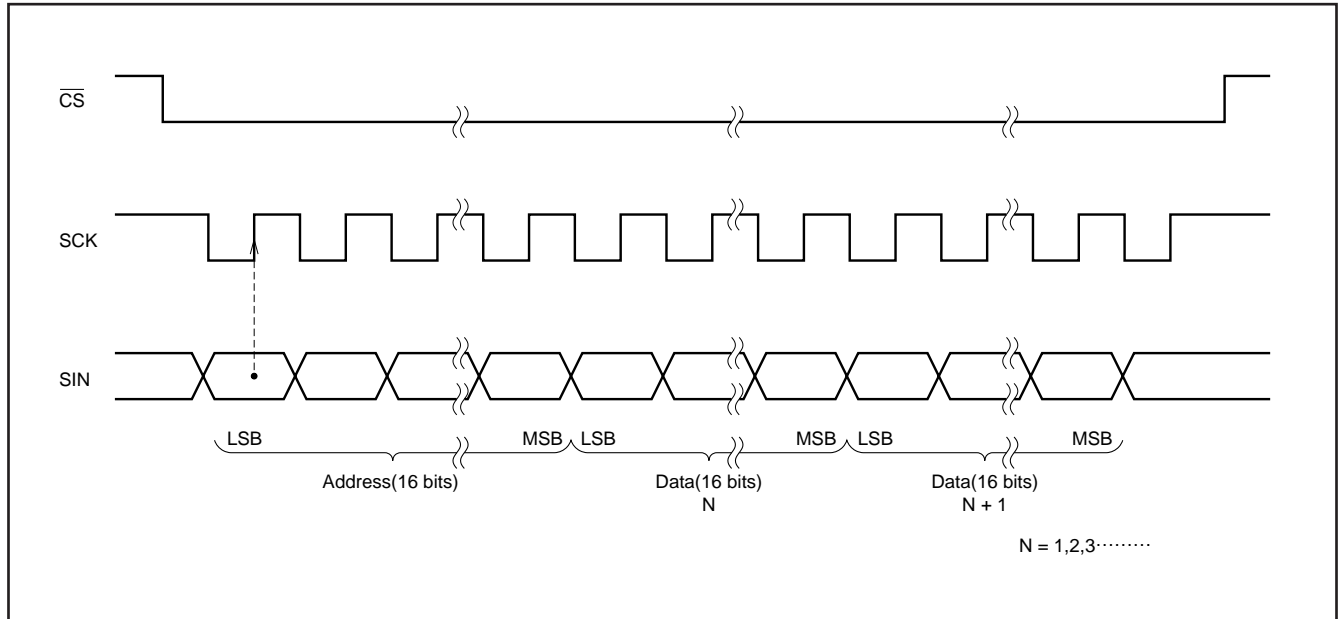

Fig. 7 Serial input timing

CHARACTER FONT

Images are composed on a 12 × 18 dot matrix, and characters can be linked vertically and horizontally with other characters to allow the display the continuous symbols.

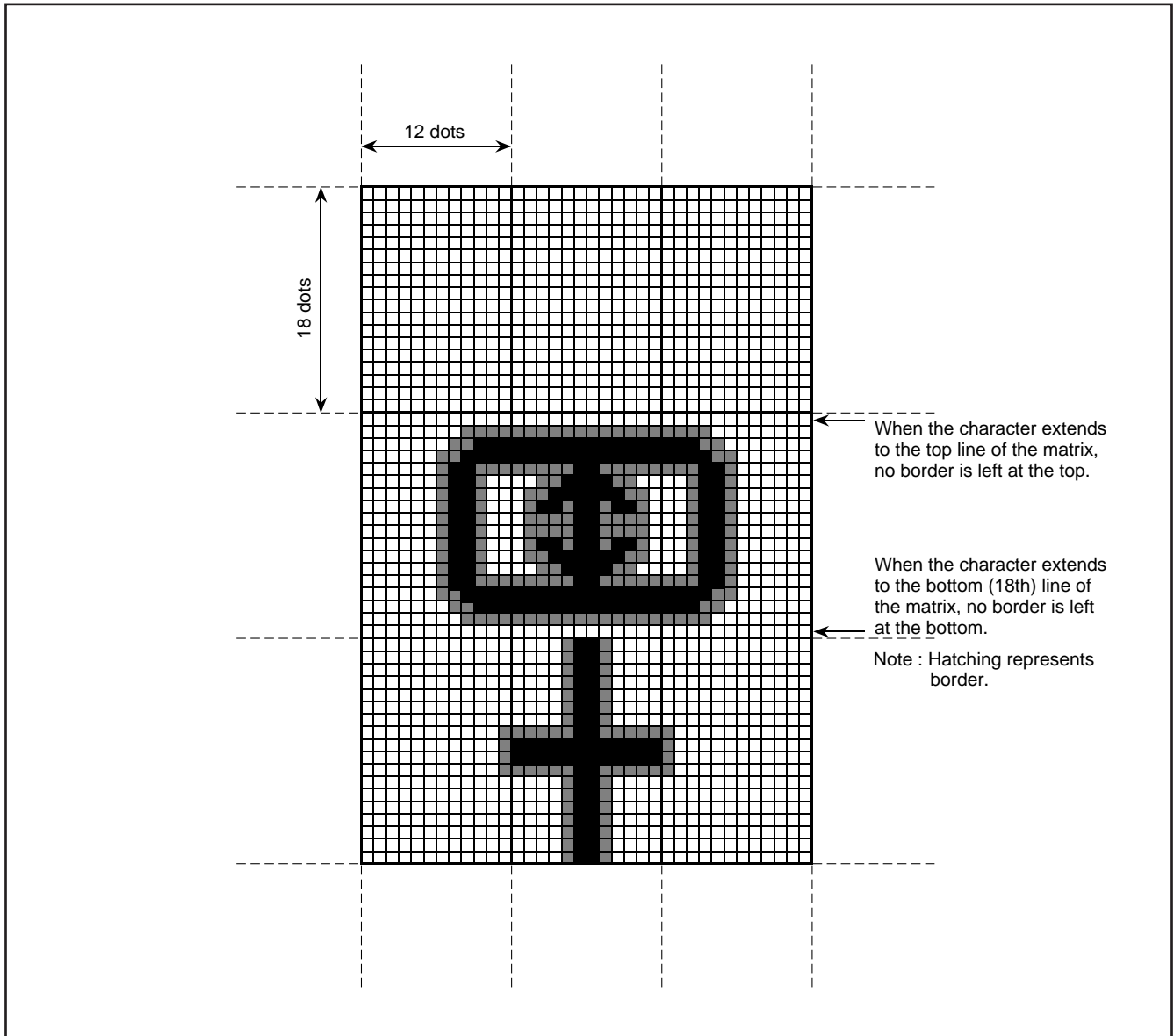

Fig. 8 Example for displaying a continuous pattern after combining characters in the horizontal or vertical direction

Character code FF16 is fixed as a blank without background. Therefore, cannot register a character font in this code.

TIMING REQUIREMENTS ($T_a = -20^{\circ}\text{C}$ to $+85^{\circ}\text{C}$, $V_{DD} = 5 \pm 0.25\text{V}$, unless otherwise noted)

Symbol	Parameter	Limits			Unit	Remarks
		Min.	Typ.	Max.		
$t_w(\text{SCK})$	SCK width	200	—	—	ns	See Figure 9
$t_{su}(\overline{\text{CS}})$	$\overline{\text{CS}}$ setup time	200	—	—	ns	
$t_h(\overline{\text{CS}})$	$\overline{\text{CS}}$ hold time	2	—	—	μs	
$t_{su}(\text{SIN})$	SIN setup time	200	—	—	ns	
$t_h(\text{SIN})$	SIN hold time	200	—	—	ns	
t_{word}	1 word writing time	10	—	—	μs	

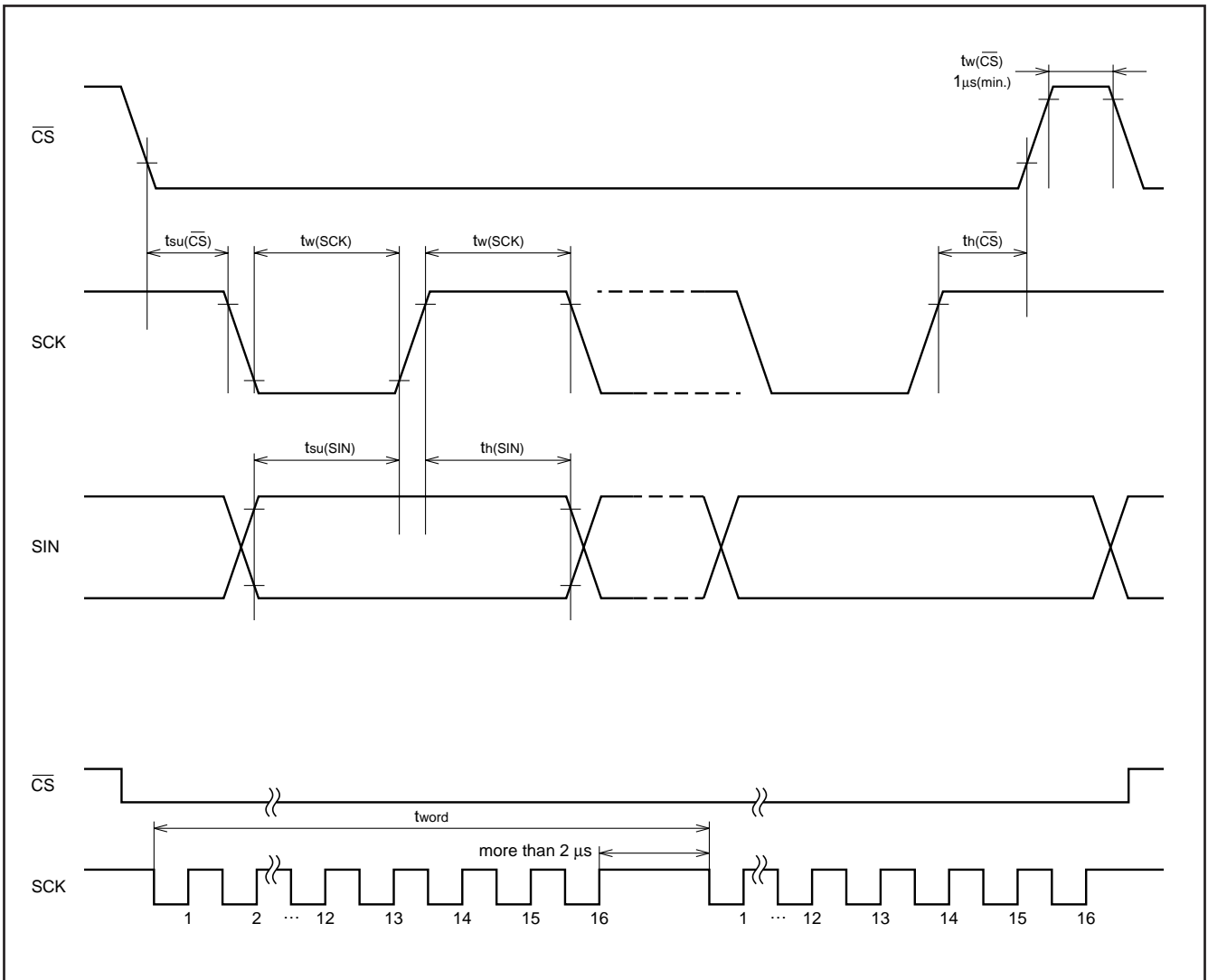

Fig. 9 Serial input timing requirements

SCREEN CHARACTER and PATTERN DISPLAY CONTROLLERS

ABSOLUTE MAXIMUM RATINGS

Symbol	Parameter	Conditions	Ratings	Unit
V _{DD}	Supply voltage	With respect to V _{SS} .	-0.3 to +6.0	V
V _I	Input voltage		V _{SS} - 0.3 ≤ V _I ≤ V _{DD} + 0.3	V
V _O	Output voltage		V _{SS} ≤ V _O ≤ V _{DD}	V
P _d	Power dissipation	T _a = 25°C	300	mW
T _{opr}	Operating temperature		-20 to +85	°C
T _{stg}	Storage temperature		-40 to +125	°C

RECOMMENDED OPERATING CONDITIONS (V_{DD} = 5V, T_a = -20 to +85°C, unless otherwise noted)

Symbol	Parameter	Limits			Unit
		Min.	Typ.	Max.	
V _{DD}	Supply voltage	4.75	5.0	5.25	V
V _{IH}	"H" level input voltage SIN, SCK, CS, AC HOR, VERT	0.8V _{DD}	V _{DD}	V _{DD}	V
V _{IL}	"L" level input voltage SIN, SCK, CS, AC HOR, VERT	0	0	0.2V _{DD}	V
F _{osc}	Oscillating frequency for display	20.0	—	80.0	MHz
Hsync	Horizontal synchronous signal input frequency	15.0	—	130.0	kHz

ELECTRICAL CHARACTERISTICS (V_{DD} = 5V, T_a = 25°C, unless otherwise noted)

Symbol	Parameter	Test conditions	Limits			Unit
			Min.	Typ.	Max.	
V _{DD}	Supply voltage	T _a = -20 to +85°C	4.75	5.0	5.25	V
I _{DD}	Supply current	V _{DD} = 5.25V	—	30	50	mA
V _{OH}	"H" level output voltage	P0 to P7	3.5	—	—	V
		CPOUT				
V _{OL}	"L" level output voltage	P0 to P7	—	—	0.4	V
		CPOUT				
R _I	Pull-up resistance SCK, AC, CS, SIN	V _{DD} = 5.0V	10	30	100	kΩ
V _{TCK}	External clock input width	4.75V < V _{DD} ≤ 5.25V	0.7V _{DD}	—	0.9V _{DD}	V _{PP}

NOTE FOR SUPPLYING POWER

Timing of power supplying to \overline{AC} pin

The internal circuit of M35046-XXXSP/FP is reset when the level of the auto clear input pin \overline{AC} is "L". This pin is hysteresis input with the pull-up resistor. The timing about power supplying of \overline{AC} pin is shown in Figure 11.

Timing of power supplying to V_{DD1} and V_{DD2} .
Supply power to V_{DD1} and V_{DD2} at the same time.

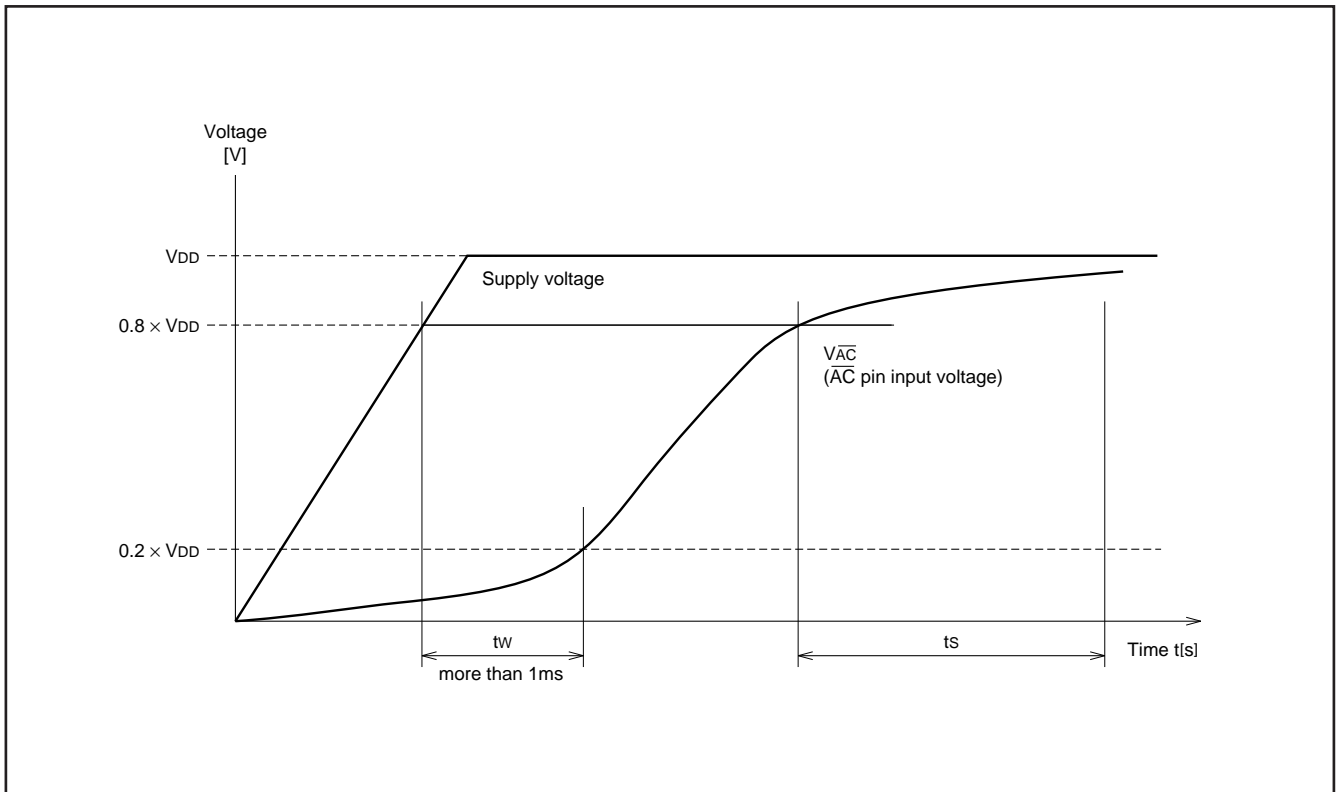

Fig. 11 Timing of power supplying to \overline{AC} pin

After supplying the power (V_{DD} and V_{SS}) to M35046-XXXSP/FP and the supply voltage becomes more than $0.8 \times V_{DD}$, it needs to keep V_{IL} time; t_w of the \overline{AC} pin for more than 1ms.

Start inputting from microcomputer after \overline{AC} pin supply voltage becomes more than $0.8 \times V_{DD}$ and keeping 200ms wait time.

PRECAUTION FOR USE

Notes on noise and latch-up

In order to avoid noise and latch-up, connect a bypass capacitor ($\approx 0.1\mu F$) directly between the V_{DD1} pin and V_{SS} pin, and the V_{DD2} pin and V_{SS} pin using a heavy wire.

DATA REQUIRED FOR MASK ROM ORDERING

Please send the following data for mask orders.

- (1) M35046-XXXSP/FP mask ROM order confirmation form
- (2) 20P4B mask specification form
- (3) 20P2Q-A mask specification form
- (4) ROM data (EPROM 3 sets)
- (5) Floppy disks containing the character font generating program + character data

STANDARD ROM TYPE : M35046-001SP/FP

M35046-001SP/FP is a standard ROM type of M35046-XXXSP/FP.

The character patterns are fixed to the contents of Figure 12 to 15.

SCREEN CHARACTER and PATTERN DISPLAY CONTROLLERS

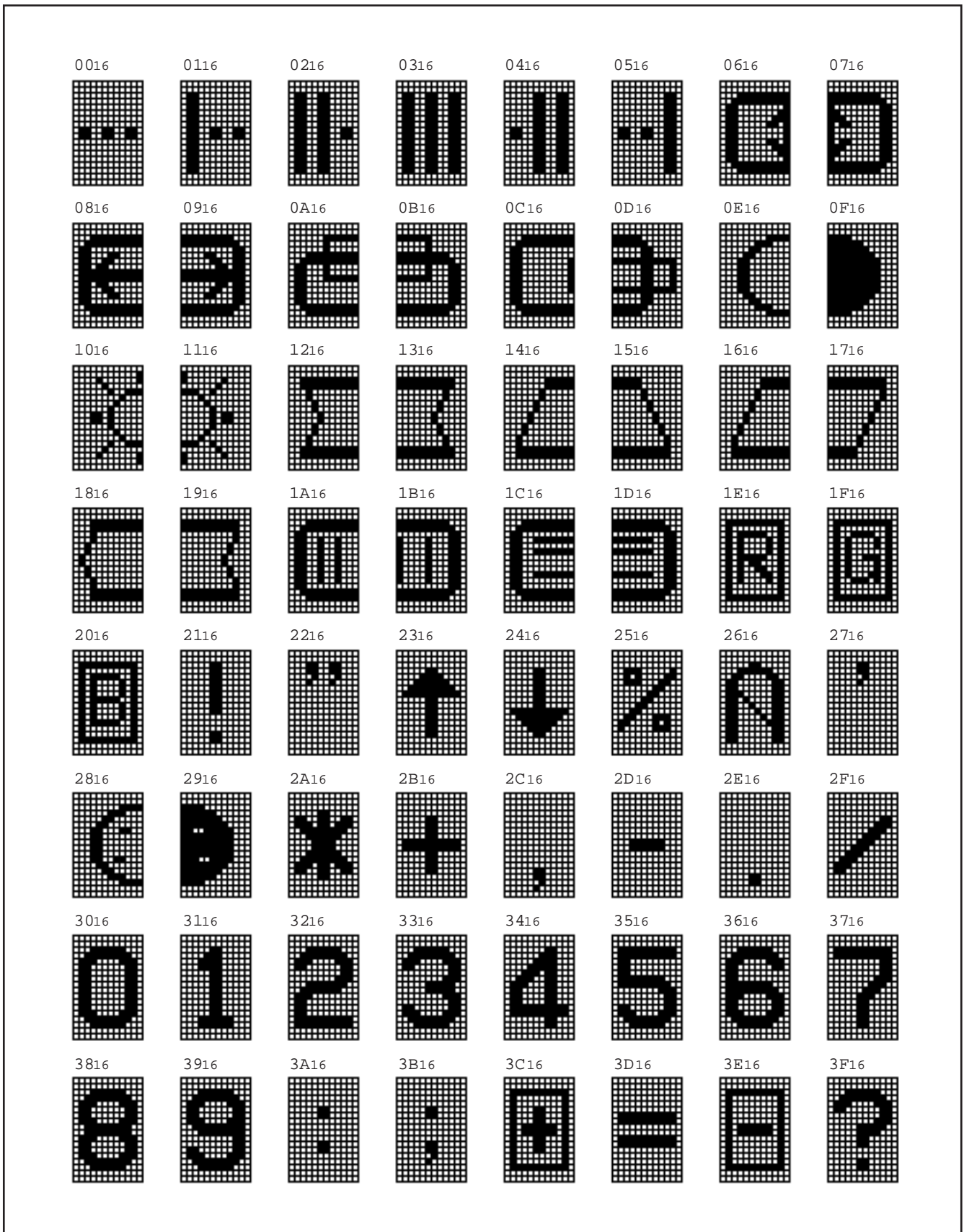

Fig. 12 M35046-001SP/FP character pattern (1)

SCREEN CHARACTER and PATTERN DISPLAY CONTROLLERS



Fig. 13 M35046-001SP/FP character pattern (2)

SCREEN CHARACTER and PATTERN DISPLAY CONTROLLERS

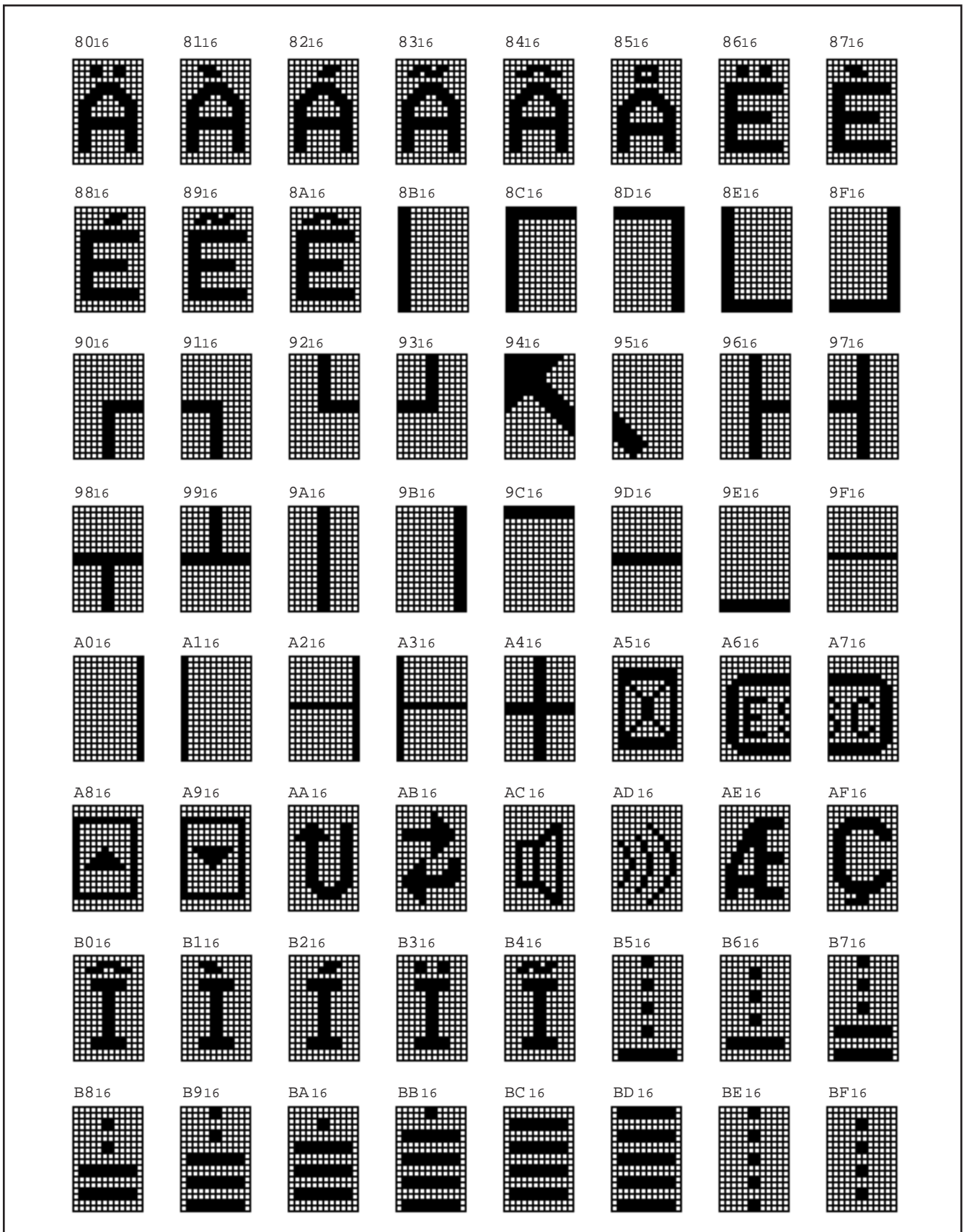

Fig. 14 M35046-001SP/FP character pattern (3)

SCREEN CHARACTER and PATTERN DISPLAY CONTROLLERS

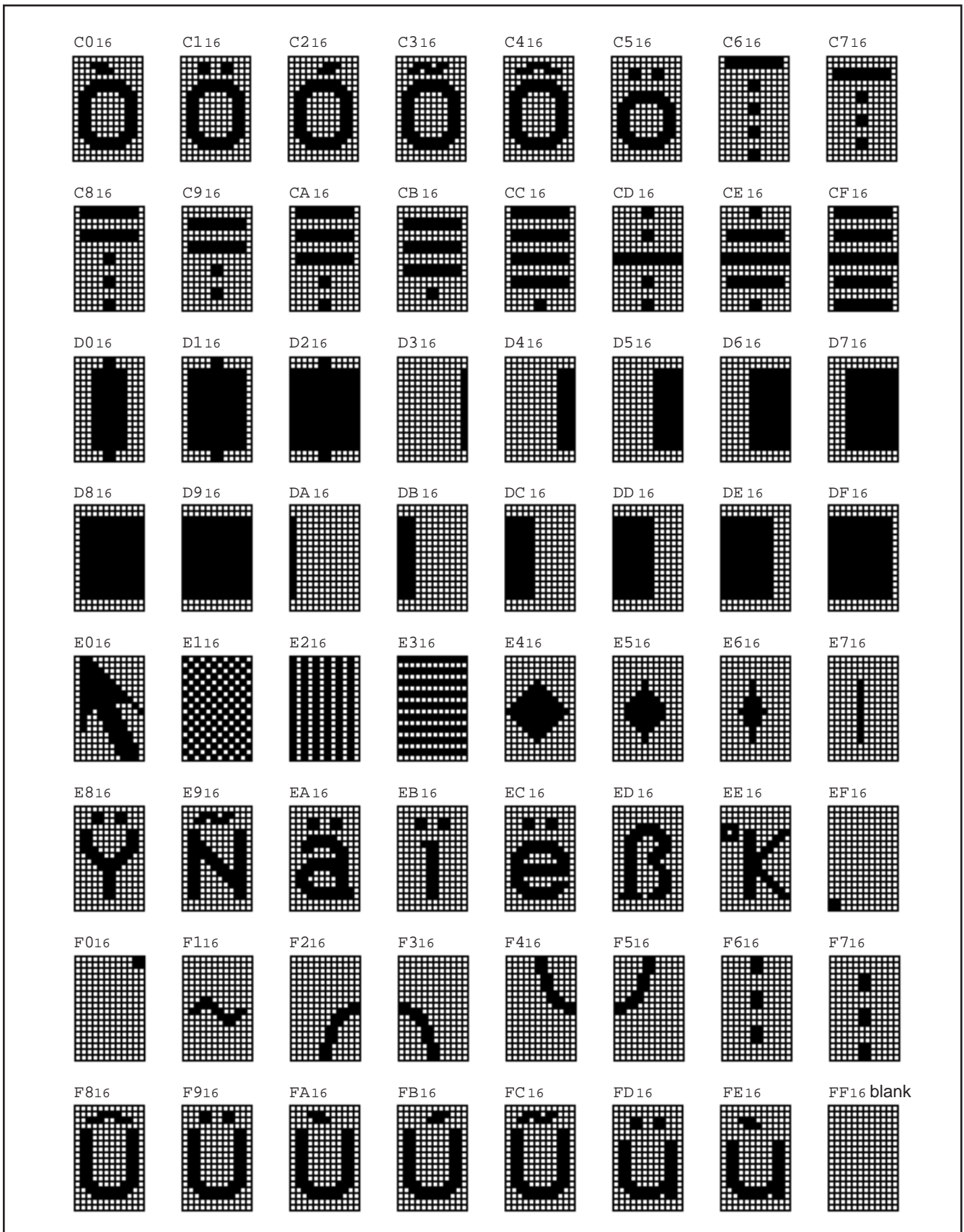
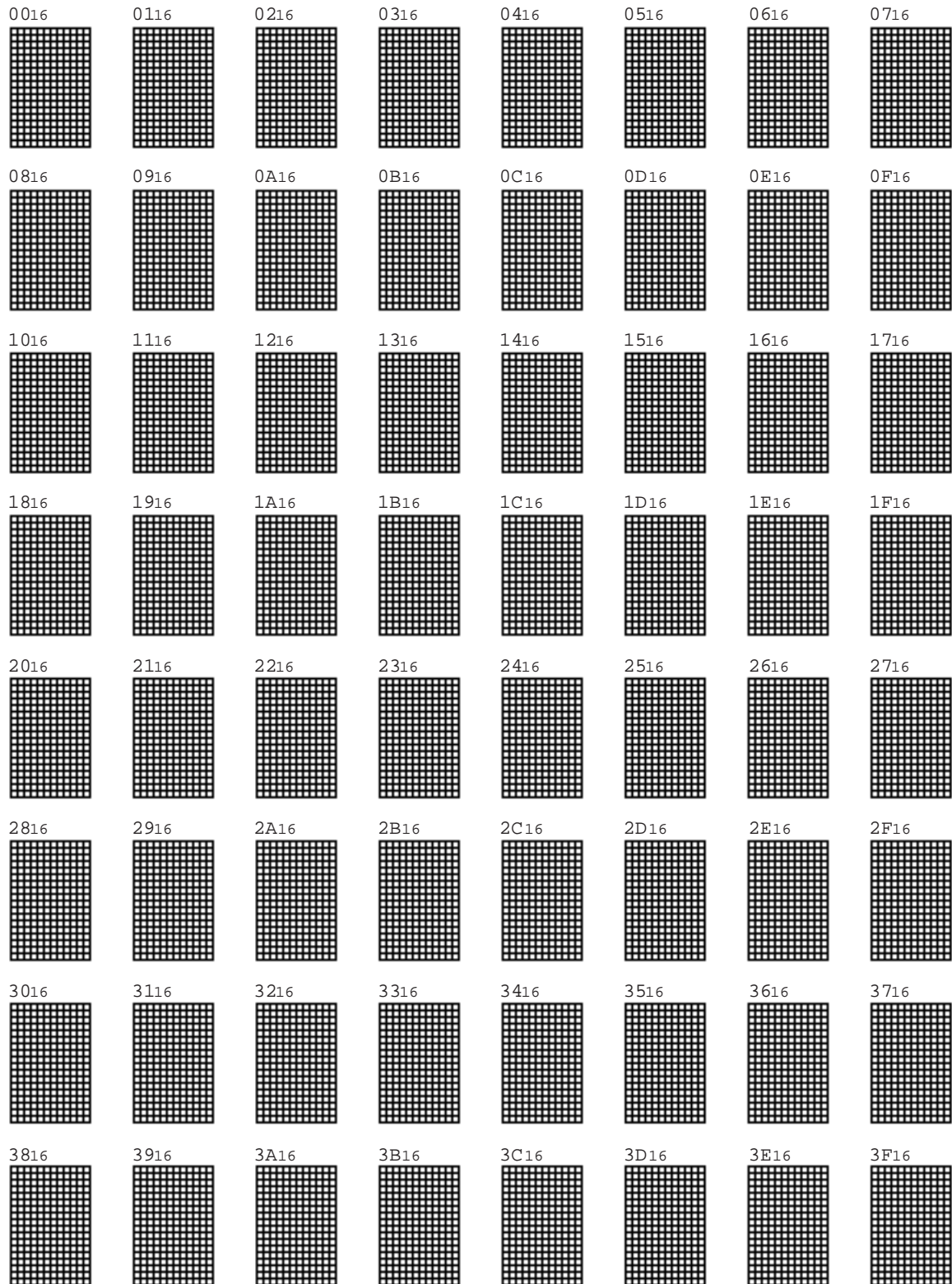

Fig. 15 M35046-001SP/FP character pattern (4)

SCREEN CHARACTER and PATTERN DISPLAY CONTROLLERS



SCREEN CHARACTER and PATTERN DISPLAY CONTROLLERS

4016	4116	4216	4316	4416	4516	4616	4716
4816	4916	4A16	4B16	4C16	4D16	4E16	4F16
5016	5116	5216	5316	5416	5516	5616	5716
5816	5916	5A16	5B16	5C16	5D16	5E16	5F16
6016	6116	6216	6316	6416	6516	6616	6716
6816	6916	6A16	6B16	6C16	6D16	6E16	6F16
7016	7116	7216	7316	7416	7516	7616	7716
7816	7916	7A16	7B16	7C16	7D16	7E16	7F16 blank

SCREEN CHARACTER and PATTERN DISPLAY CONTROLLERS

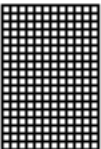
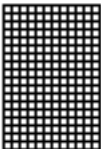
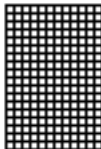
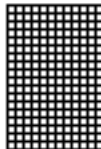
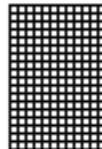
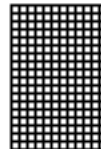
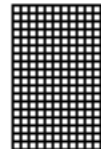
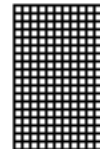
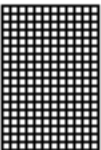
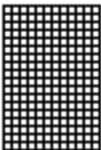
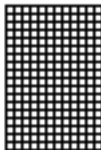
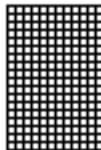
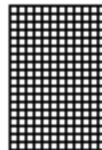
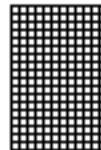
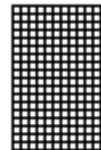
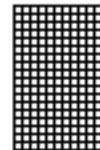
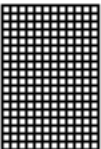
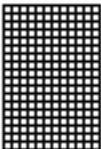
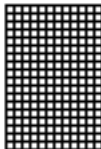
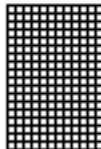
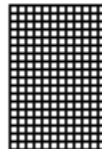
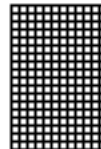
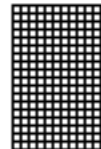
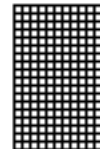
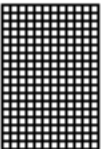
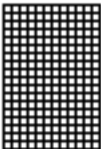
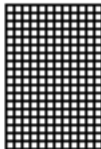
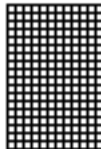
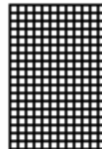
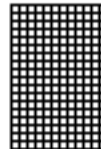
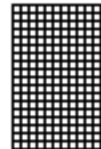
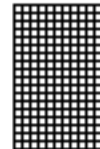
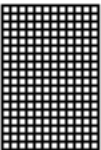
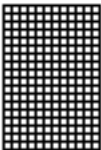
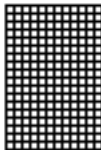
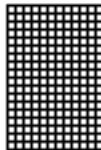
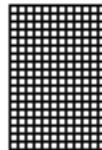
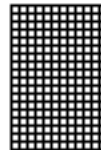
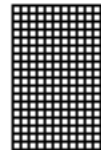
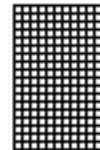
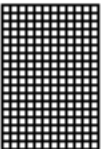
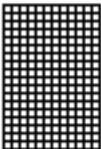
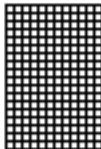
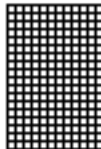
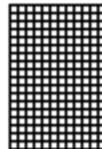
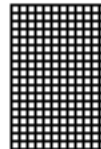
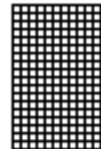
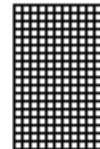
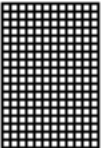
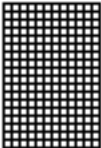
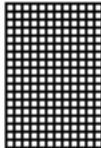
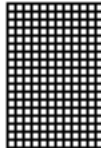
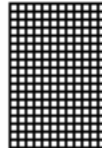
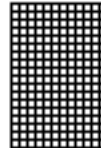
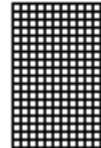
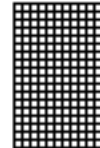
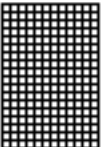
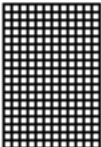
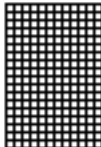
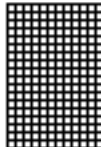
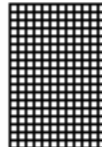
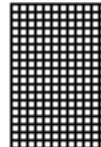
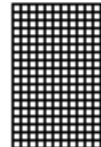
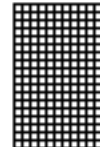
80 ₁₆ 	81 ₁₆ 	82 ₁₆ 	83 ₁₆ 	84 ₁₆ 	85 ₁₆ 	86 ₁₆ 	87 ₁₆ 
88 ₁₆ 	89 ₁₆ 	8A ₁₆ 	8B ₁₆ 	8C ₁₆ 	8D ₁₆ 	8E ₁₆ 	8F ₁₆ 
90 ₁₆ 	91 ₁₆ 	92 ₁₆ 	93 ₁₆ 	94 ₁₆ 	95 ₁₆ 	96 ₁₆ 	97 ₁₆ 
98 ₁₆ 	99 ₁₆ 	9A ₁₆ 	9B ₁₆ 	9C ₁₆ 	9D ₁₆ 	9E ₁₆ 	9F ₁₆ 
A0 ₁₆ 	A1 ₁₆ 	A2 ₁₆ 	A3 ₁₆ 	A4 ₁₆ 	A5 ₁₆ 	A6 ₁₆ 	A7 ₁₆ 
A8 ₁₆ 	A9 ₁₆ 	AA ₁₆ 	AB ₁₆ 	AC ₁₆ 	AD ₁₆ 	AE ₁₆ 	AF ₁₆ 
B0 ₁₆ 	B1 ₁₆ 	B2 ₁₆ 	B3 ₁₆ 	B4 ₁₆ 	B5 ₁₆ 	B6 ₁₆ 	B7 ₁₆ 
B8 ₁₆ 	B9 ₁₆ 	BA ₁₆ 	BB ₁₆ 	BC ₁₆ 	BD ₁₆ 	BE ₁₆ 	BF ₁₆ 

SCREEN CHARACTER and PATTERN DISPLAY CONTROLLERS

C0 ₁₆	C1 ₁₆	C2 ₁₆	C3 ₁₆	C4 ₁₆	C5 ₁₆	C6 ₁₆	C7 ₁₆
C8 ₁₆	C9 ₁₆	CA ₁₆	CB ₁₆	CC ₁₆	CD ₁₆	CE ₁₆	CF ₁₆
D0 ₁₆	D1 ₁₆	D2 ₁₆	D3 ₁₆	D4 ₁₆	D5 ₁₆	D6 ₁₆	D7 ₁₆
D8 ₁₆	D9 ₁₆	DA ₁₆	DB ₁₆	DC ₁₆	DD ₁₆	DE ₁₆	DF ₁₆
E0 ₁₆	E1 ₁₆	E2 ₁₆	E3 ₁₆	E4 ₁₆	E5 ₁₆	E6 ₁₆	E7 ₁₆
E8 ₁₆	E9 ₁₆	EA ₁₆	EB ₁₆	EC ₁₆	ED ₁₆	EE ₁₆	EF ₁₆
F0 ₁₆	F1 ₁₆	F2 ₁₆	F3 ₁₆	F4 ₁₆	F5 ₁₆	F6 ₁₆	F7 ₁₆
F8 ₁₆	F9 ₁₆	FA ₁₆	FB ₁₆	FC ₁₆	FD ₁₆	FE ₁₆	FF ₁₆ blank

PACKAGE OUTLINE

20P4B

Plastic 20pin 300mil SDIP

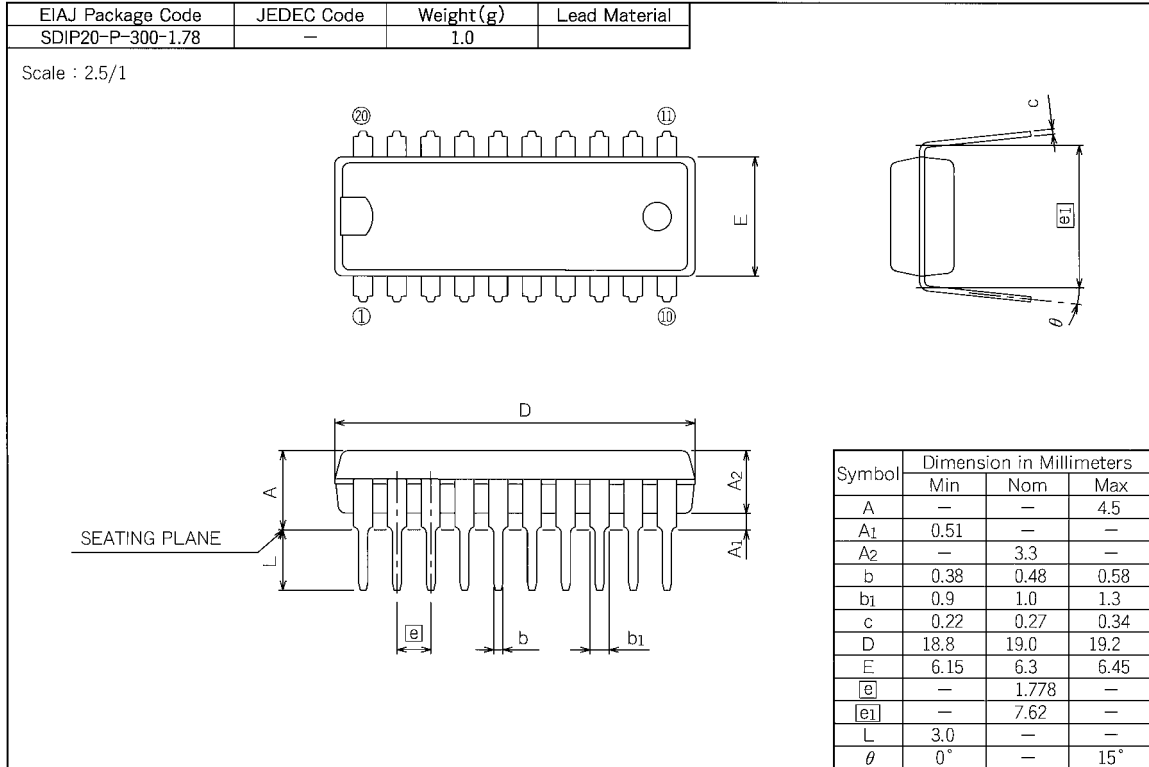

20P2Q-A

Plastic 20pin 300mil SSOP

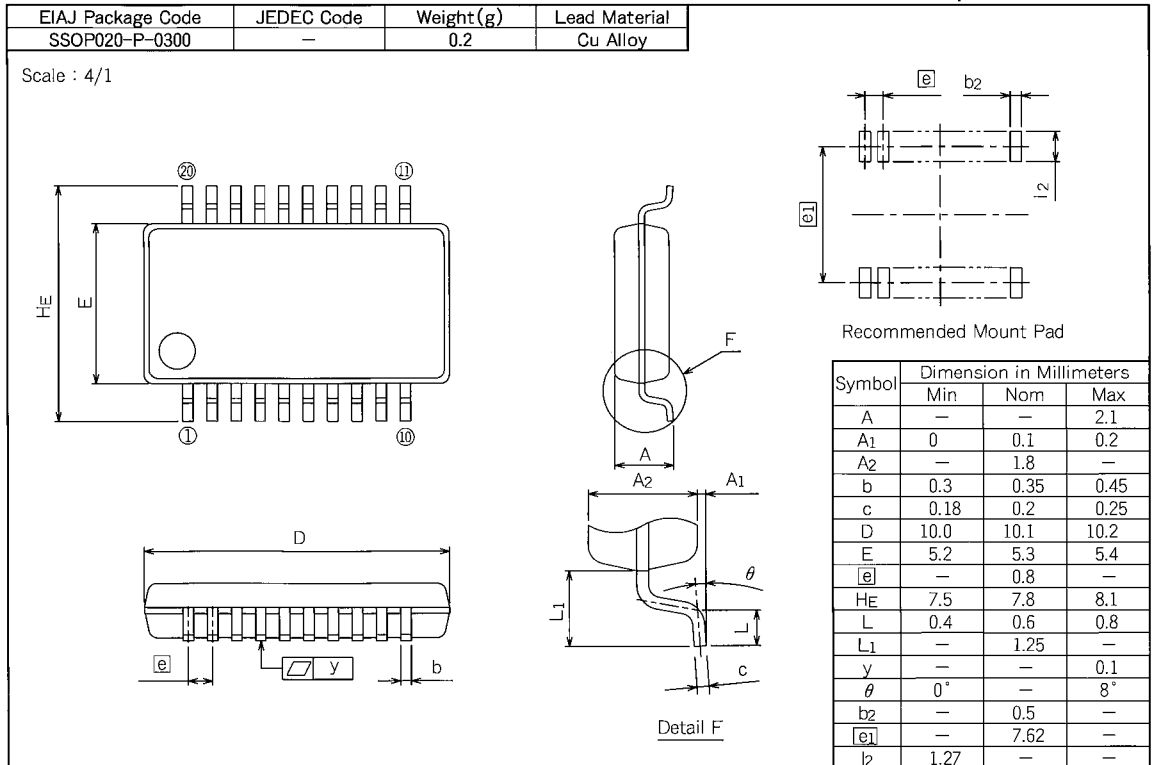

MEMO

