

# DDR2 Unbuffered SDRAM MODULE

**240pin Unbuffered Module based on 512Mb B-die**

**64/72-bit Non-ECC/ECC**

Revision 1.2

January 2005

## 256MB,512MB,1GB Unbuffered DIMMs

## DDR2 SDRAM

### DDR2 Unbuffered DIMM Ordering Information

Part Number	Density	Organization	Component Composition	Number of Rank	Height
<b>x64 Non ECC</b>					
M378T3354BG(Z)0-CD5/CC	256MB	32Mx64	32Mx16(K4T51163QB)*4	1	30mm
M378T6553BG(Z)0-CD5/CC	512MB	64Mx64	64Mx8(K4T51083QB)*8	1	30mm
M378T2953BG(Z)0-CD5/CC	1GB	128Mx64	64Mx8(K4T51083QB)*16	2	30mm
<b>x72 ECC</b>					
M391T6553BG(Z)0-CD5/CC	512MB	64Mx72	64Mx8(K4T51083QB)*9	1	30mm
M391T2953BG(Z)0-CD5/CC	1GB	128Mx72	64Mx8(K4T51083QB)*18	2	30mm

Note: "Z" of Part number stand for Lead-free products.

### Features

- Performance range

	D5(DDR2-533)	CC(DDR2-400)	Unit
Speed@CL3	400	400	Mbps
Speed@CL4	533	400	Mbps
Speed@CL5	-	-	Mbps
CL-tRCD-tRP	4-4-4	3-3-3	CK

- JEDEC standard 1.8V  $\pm$  0.1V Power Supply
- VDDQ = 1.8V  $\pm$  0.1V
- 200 MHz  $f_{CK}$  for 400Mb/sec/pin, 267MHz  $f_{CK}$  for 533Mb/sec/pin
- 4 Bank
- Posted  $\overline{CAS}$
- Programmable  $\overline{CAS}$  Latency: 3, 4, 5
- Programmable Additive Latency: 0, 1, 2, 3 and 4
- Write Latency(WL) = Read Latency(RL) -1
- Burst Length: 4, 8(Interleave/nibble sequential)
- Programmable Sequential / Interleave Burst Mode
- Bi-directional Differential Data-Strobe (Single-ended data-strobe is an optional feature)
- Off-Chip Driver(OCD) Impedance Adjustment
- On Die Termination
- Average Refresh Period 7.8us at lower then  $T_{CASE}$  85xC, 3.9us at 85xC <  $T_{CASE}$   $\leq$  95 xC
- Serial presence detect with EEPROM
- DDR2 SDRAM Package: 60ball FBGA - 64Mx8, 84ball FBGA - 32Mx16
- All of Lead-free products are compliant for RoHS

Note: For detailed DDR2 SDRAM operation, please refer to Samsung's Device operation & Timing diagram.

# 256MB,512MB,1GB Unbuffered DIMMs

# DDR2 SDRAM

## Address Configuration

Organization	Row Address	Column Address	Bank Address	Auto Precharge
64Mx8(512Mb) based Module	A0-A13	A0-A9	BA0-BA1	A10
32Mx16(512Mb) based Module	A0-A12	A0-A9	BA0-BA1	A10

## x64 DIMM Pin Configurations (Front side/Back side)

Pin	Front	Pin	Back	Pin	Front	Pin	Back	Pin	Front	Pin	Back	Pin	Front	Pin	Back
1	V <sub>REF</sub>	121	V <sub>SS</sub>	31	DQ19	151	V <sub>SS</sub>	61	A4	181	V <sub>DDQ</sub>	91	V <sub>SS</sub>	211	DM5
2	V <sub>SS</sub>	122	DQ4	32	V <sub>SS</sub>	152	DQ28	62	V <sub>DDQ</sub>	182	A3	92	DQS5	212	NC
3	DQ0	123	DQ5	33	DQ24	153	DQ29	63	A2	183	A1	93	DQS5	213	V <sub>SS</sub>
4	DQ1	124	V <sub>SS</sub>	34	DQ25	154	V <sub>SS</sub>	64	V <sub>DD</sub>	184	V <sub>DD</sub>	94	V <sub>SS</sub>	214	DQ46
5	V <sub>SS</sub>	125	DM0	35	V <sub>SS</sub>	155	DM3	KEY				95	DQ42	215	DQ47
6	DQS0	126	NC	36	DQS3	156	NC	65	V <sub>SS</sub>	185	CK0	96	DQ43	216	V <sub>SS</sub>
7	DQS0	127	V <sub>SS</sub>	37	DQS3	157	V <sub>SS</sub>	66	V <sub>SS</sub>	186	CK0	97	V <sub>SS</sub>	217	DQ52
8	V <sub>SS</sub>	128	DQ6	38	V <sub>SS</sub>	158	DQ30	67	V <sub>DD</sub>	187	V <sub>DD</sub>	98	DQ48	218	DQ53
9	DQ2	129	DQ7	39	DQ26	159	DQ31	68	NC	188	A0	99	DQ49	219	V <sub>SS</sub>
10	DQ3	130	V <sub>SS</sub>	40	DQ27	160	V <sub>SS</sub>	69	V <sub>DD</sub>	189	V <sub>DD</sub>	100	V <sub>SS</sub>	220	CK2
11	V <sub>SS</sub>	131	DQ12	41	V <sub>SS</sub>	161	NC	70	A10/AP	190	BA1	101	SA2	221	CK2
12	DQ8	132	DQ13	42	NC	162	NC	71	BA0	191	V <sub>DDQ</sub>	102	NC, TEST <sup>2</sup>	222	V <sub>SS</sub>
13	DQ9	133	V <sub>SS</sub>	43	NC	163	V <sub>SS</sub>	72	V <sub>DDQ</sub>	192	RAS	103	V <sub>SS</sub>	223	DM6
14	V <sub>SS</sub>	134	DM1	44	V <sub>SS</sub>	164	NC	73	WE	193	S0	104	DQS6	224	NC
15	DQS1	135	NC	45	NC	165	NC	74	CAS	194	V <sub>DDQ</sub>	105	DQS6	225	V <sub>SS</sub>
16	DQS1	136	V <sub>SS</sub>	46	NC	166	V <sub>SS</sub>	75	V <sub>DDQ</sub>	195	ODT0	106	V <sub>SS</sub>	226	DQ54
17	V <sub>SS</sub>	137	CK1	47	V <sub>SS</sub>	167	NC	76	S1	196	A13 <sup>1</sup>	107	DQ50	227	DQ55
18	NC	138	CK1	48	NC	168	NC	77	ODT1	197	V <sub>DD</sub>	108	DQ51	228	V <sub>SS</sub>
19	NC	139	V <sub>SS</sub>	49	NC	169	V <sub>SS</sub>	78	V <sub>DDQ</sub>	198	V <sub>SS</sub>	109	V <sub>SS</sub>	229	DQ60
20	V <sub>SS</sub>	140	DQ14	50	V <sub>SS</sub>	170	V <sub>DDQ</sub>	79	V <sub>SS</sub>	199	DQ36	110	DQ56	230	DQ61
21	DQ10	141	DQ15	51	V <sub>DDQ</sub>	171	CKE1	80	DQ32	200	DQ37	111	DQ57	231	V <sub>SS</sub>
22	DQ11	142	V <sub>SS</sub>	52	CKE0	172	V <sub>DD</sub>	81	DQ33	201	V <sub>SS</sub>	112	V <sub>SS</sub>	232	DM7
23	V <sub>SS</sub>	143	DQ20	53	V <sub>DD</sub>	173	NC	82	V <sub>SS</sub>	202	DM4	113	DQS7	233	NC
24	DQ16	144	DQ21	54	NC	174	NC	83	DQS4	203	NC	114	DQS7	234	V <sub>SS</sub>
25	DQ17	145	V <sub>SS</sub>	55	NC	175	V <sub>DDQ</sub>	84	DQS4	204	V <sub>SS</sub>	115	V <sub>SS</sub>	235	DQ62
26	V <sub>SS</sub>	146	DM2	56	V <sub>DDQ</sub>	176	A12	85	V <sub>SS</sub>	205	DQ38	116	DQ58	236	DQ63
27	DQS2	147	NC	57	A11	177	A9	86	DQ34	206	DQ39	117	DQ59	237	V <sub>SS</sub>
28	DQS2	148	V <sub>SS</sub>	58	A7	178	V <sub>DD</sub>	87	DQ35	207	V <sub>SS</sub>	118	V <sub>SS</sub>	238	VDDSPD
29	V <sub>SS</sub>	149	DQ22	59	V <sub>DD</sub>	179	A8	88	V <sub>SS</sub>	208	DQ44	119	SDA	239	SA0
30	DQ18	150	DQ23	60	A5	180	A6	89	DQ40	209	DQ45	120	SCL	240	SA1
								90	DQ41	210	V <sub>SS</sub>				

NC = No Connect, RFU = Reserved for Future Use

1. Pin196(A13) is used for x4/x8 base Unbuffered DIMM.

2. The TEST pin is reserved for bus analysis tools and is not connected on standard memory module products (DIMMs.)

SAMSUNG ELECTRONICS CO., Ltd. reserves the right to change products and specifications without notice.

# 256MB,512MB,1GB Unbuffered DIMMs

# DDR2 SDRAM

## x72 DIMM Pin Configurations (Front side/Back side)

Pin	Front	Pin	Back	Pin	Front	Pin	Back	Pin	Front	Pin	Back	Pin	Front	Pin	Back
1	V <sub>REF</sub>	121	V <sub>SS</sub>	31	DQ19	151	V <sub>SS</sub>	61	A4	181	V <sub>DDQ</sub>	91	V <sub>SS</sub>	211	DM5
2	V <sub>SS</sub>	122	DQ4	32	V <sub>SS</sub>	152	DQ28	62	V <sub>DDQ</sub>	182	A3	92	DQS5	212	NC
3	DQ0	123	DQ5	33	DQ24	153	DQ29	63	A2	183	A1	93	DQS5	213	V <sub>SS</sub>
4	DQ1	124	V <sub>SS</sub>	34	DQ25	154	V <sub>SS</sub>	64	V <sub>DD</sub>	184	V <sub>DD</sub>	94	V <sub>SS</sub>	214	DQ46
5	V <sub>SS</sub>	125	DM0	35	V <sub>SS</sub>	155	DM3	KEY				95	DQ42	215	DQ47
6	DQS0	126	NC	36	DQS3	156	NC					65	V <sub>SS</sub>	185	CK0
7	DQS0	127	V <sub>SS</sub>	37	DQS3	157	V <sub>SS</sub>	66	V <sub>SS</sub>	186	CK0	97	V <sub>SS</sub>	217	DQ52
8	V <sub>SS</sub>	128	DQ6	38	V <sub>SS</sub>	158	DQ30	67	V <sub>DD</sub>	187	V <sub>DD</sub>	98	DQ48	218	DQ53
9	DQ2	129	DQ7	39	DQ26	159	DQ31	68	NC	188	A0	99	DQ49	219	V <sub>SS</sub>
10	DQ3	130	V <sub>SS</sub>	40	DQ27	160	V <sub>SS</sub>	69	V <sub>DD</sub>	189	V <sub>DD</sub>	100	V <sub>SS</sub>	220	CK2
11	V <sub>SS</sub>	131	DQ12	41	V <sub>SS</sub>	161	CB4	70	A10/AP	190	BA1	101	SA2	221	CK2
12	DQ8	132	DQ13	42	CB0	162	CB5	71	BA0	191	V <sub>DDQ</sub>	102	NC, TEST <sup>2</sup>	222	V <sub>SS</sub>
13	DQ9	133	V <sub>SS</sub>	43	CB1	163	V <sub>SS</sub>	72	V <sub>DDQ</sub>	192	RAS	103	V <sub>SS</sub>	223	DM6
14	V <sub>SS</sub>	134	DM1	44	V <sub>SS</sub>	164	DM8	73	WE	193	S0	104	DQS6	224	NC
15	DQS1	135	NC	45	DQS8	165	NC	74	CAS	194	V <sub>DDQ</sub>	105	DQS6	225	V <sub>SS</sub>
16	DQS1	136	V <sub>SS</sub>	46	DQS8	166	V <sub>SS</sub>	75	V <sub>DDQ</sub>	195	ODT0	106	V <sub>SS</sub>	226	DQ54
17	V <sub>SS</sub>	137	CK1	47	V <sub>SS</sub>	167	CB6	76	S1	196	A13	107	DQ50	227	DQ55
18	NC	138	CK1	48	CB2	168	CB7	77	ODT1	197	V <sub>DD</sub>	108	DQ51	228	V <sub>SS</sub>
19	NC	139	V <sub>SS</sub>	49	CB3	169	V <sub>SS</sub>	78	V <sub>DDQ</sub>	198	V <sub>SS</sub>	109	V <sub>SS</sub>	229	DQ60
20	V <sub>SS</sub>	140	DQ14	50	V <sub>SS</sub>	170	V <sub>DDQ</sub>	79	V <sub>SS</sub>	199	DQ36	110	DQ56	230	DQ61
21	DQ10	141	DQ15	51	V <sub>DDQ</sub>	171	CKE1	80	DQ32	200	DQ37	111	DQ57	231	V <sub>SS</sub>
22	DQ11	142	V <sub>SS</sub>	52	CKE0	172	V <sub>DD</sub>	81	DQ33	201	V <sub>SS</sub>	112	V <sub>SS</sub>	232	DM7
23	V <sub>SS</sub>	143	DQ20	53	V <sub>DD</sub>	173	NC	82	V <sub>SS</sub>	202	DM4	113	DQS7	233	NC
24	DQ16	144	DQ21	54	NC	174	NC	83	DQS4	203	NC	114	DQS7	234	V <sub>SS</sub>
25	DQ17	145	V <sub>SS</sub>	55	NC	175	V <sub>DDQ</sub>	84	DQS4	204	V <sub>SS</sub>	115	V <sub>SS</sub>	235	DQ62
26	V <sub>SS</sub>	146	DM2	56	V <sub>DDQ</sub>	176	A12	85	V <sub>SS</sub>	205	DQ38	116	DQ58	236	DQ63
27	DQS2	147	NC	57	A11	177	A9	86	DQ34	206	DQ39	117	DQ59	237	V <sub>SS</sub>
28	DQS2	148	V <sub>SS</sub>	58	A7	178	V <sub>DD</sub>	87	DQ35	207	V <sub>SS</sub>	118	V <sub>SS</sub>	238	VDDSPD
29	V <sub>SS</sub>	149	DQ22	59	V <sub>DD</sub>	179	A8	88	V <sub>SS</sub>	208	DQ44	119	SDA	239	SA0
30	DQ18	150	DQ23	60	A5	180	A6	89	DQ40	209	DQ45	120	SCL	240	SA1
								90	DQ41	210	V <sub>SS</sub>				

NC = No Connect, RFU = Reserved for Future Use

1. Pin196(A13) is used for x4/x8 base Unbuffered DIMM.

2. The TEST pin is reserved for bus analysis tools and is not connected on standard memory module products (DIMMs).

SAMSUNG ELECTRONICS CO., Ltd. reserves the right to change products and specifications without notice.

## Pin Description

Pin Name	Description	Pin Name	Description
A0-A13	DDR2 SDRAM address bus	CK0, CK1, CK2	DDR2 SDRAM clocks (positive line of differential pair)
BA0, BA1	DDR2 SDRAM bank select	CK0, CK1, CK2	DDR2 SDRAM clocks (negative line of differential pair)
RAS	DDR2 SDRAM row address strobe	SCL	I <sup>2</sup> C serial bus clock for EEPROM
CAS	DDR2 SDRAM column address strobe	SDA	I <sup>2</sup> C serial bus data line for EEPROM
WE	DDR2 SDRAM write enable	SA0-SA2	I <sup>2</sup> C serial address select for EEPROM
S0, S1	DIMM Rank Select Lines	V <sub>DD</sub> *	DDR2 SDRAM core power supply
CKE0,CKE1	DDR2 SDRAM clock enable lines	V <sub>DDQ</sub> *	DDR2 SDRAM I/O Driver power supply
ODT0, ODT1	On-die termination control lines	V <sub>REF</sub>	DDR2 SDRAM I/O reference supply
DQ0 - DQ63	DIMM memory data bus	V <sub>SS</sub>	Power supply return (ground)
CB0 - CB7	DIMM ECC check bits	V <sub>DD</sub> SPD	Serial EEPROM positive power supply
DQS0 - DQS8	DDR2 SDRAM data strobes	NC	Spare Pins(no connect)
DM(0-8)	DDR2 SDRAM data masks	RESET	Not used on UDIMM
DQS0-DQS8	DDR2 SDRAM differential data strobes	TEST	Used by memory bus analysis tools (unused on memory DIMMs)

\*The VDD and VDDQ pins are tied to the single power-plane on PCB.

## Input/Output Functional Description

Symbol	Type	Function
$\overline{CK0-CK2}$ $\overline{CK0-CK2}$	Input	CK and $\overline{CK}$ are differential clock inputs. All the SDRAM addr/cntl inputs are sampled on the crossing of positive edge of CK and negative edge of $\overline{CK}$ . Output (read) data is reference to the crossing of CK and $\overline{CK}$ (Both directions of crossing)
CKE0-CKE1	Input	Activates the SDRAM CK signal when high and deactivates the CK Signal When low. By deactivating the clocks, CKE low initiates the Powe Down mode, or the Self-Refresh mode
$\overline{S0-S1}$	Input	Enables the associated SDRAM command decoder when low and disables the command decoder when high. When the command decoder is disbled, new command are ignored but previous operations continue. This signal provides for external rank selection on systems with multiple ranks
$\overline{RAS}$ , $\overline{CAS}$ , $\overline{WE}$	Input	$\overline{RAS}$ , $\overline{CAS}$ , and $\overline{WE}$ (ALONG WITH CS) define the command being entered.
ODT0-ODT1	Input	When high, termination resistance is enabled for all DQ, $\overline{DQ}$ and DM pins, assuming the function is enabled in the Extended Mode Register Set (EMRS).
$V_{REF}$	Supply	Reference voltage for SSTL 18 inputs.
$V_{DDQ}$	Supply	Power supply for the DDR II SDRAM output buffers to provide improved noise immunity. For all current DDR2 unbuffered DIMM designs, VDDQ shares the same power plane as VDD pins.
BA0-BA1	Input	Selects which SDRAM BANK of four is activated.
A0-A13	Input	During a Bank Activate command cycle, Address input defines the row address (RA0-RA13)  During a Read or Write command cycle, Address input defines the colum address, In addition to the column address, AP is used to invoke autoprecharge operation at the end of the burst read or write cycle. If AP is high, autoprecharge is selected and BA0, BA1 defines the bank to be precharged. If AP is low, autoprecharge is disbled. During a precharge command cycle, AP is used in conjunction with BA0, BA1 to control which bank(s) to precharge. If AP is high, all banks will be precharged regardless of the state of BA0, BA1. If AP is low, BA0, BA1are used to define which bank to precharge.
DQ0-DQ63 CB0-CB7	In/Out	Data and Check Bit Input/Output pins.
DM0-DM8	Input	DM is an input mask signal for write data. Input data is masked when DM is sampled High coincident with that input data during a write access. DM is sampled on both edges of DQS. Although DM pins are input only, the DM loading matches the DQ and DQS loading.
$V_{DD}$ , $V_{SS}$	Supply	Power and ground for DDR2 SDRAM input buffers, and core logic. VDD and VDDQ pins are tied to $V_{DD}/V_{DDQ}$ planes on these modules.
$\overline{DQS0-DQS8}$ $\overline{DQS0-DQS8}$	In/Out	Data strobe for input and output data. For Rawcards using x16 orginized DRAMs DQ0-7 connect to the LDQS pin of the DRAMs and DQ8-17 connect to the UDQS pin of the DRAM
SA0-SA2	Input	These signals and tied at the system planar to either $V_{SS}$ or $V_{DD}$ to configure the serial SPD EER-POM address range.
SDA	In/Out	This bidirectional pin is used to transfer data into or out of the SPD EEPROM. A resistor must be connected from the SDA bus line to VDD to act as a pullup on the system board.
SCL	Input	This signal is used to clock data into and out of the SPD EEPROM. A resistor may be connected from the SCL bus time to VDD to act as a pullup onthe system board.
$V_{DD}$ SPD	Supply	Power supply for SPD EEPROM. This supply is separate from the $V_{DD}/V_{DDQ}$ power plane. EEPROM supply is operable from 1.7V to 3.6V.

# 256MB,512MB,1GB Unbuffered DIMMs

# DDR2 SDRAM

## Functional Block Diagram: 512MB, 64Mx64 Module (Populated as 1 rank of x8 DDR2 SDRAMs) M378T6553BG(Z)0

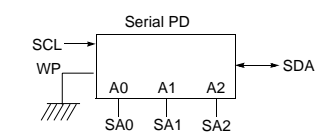
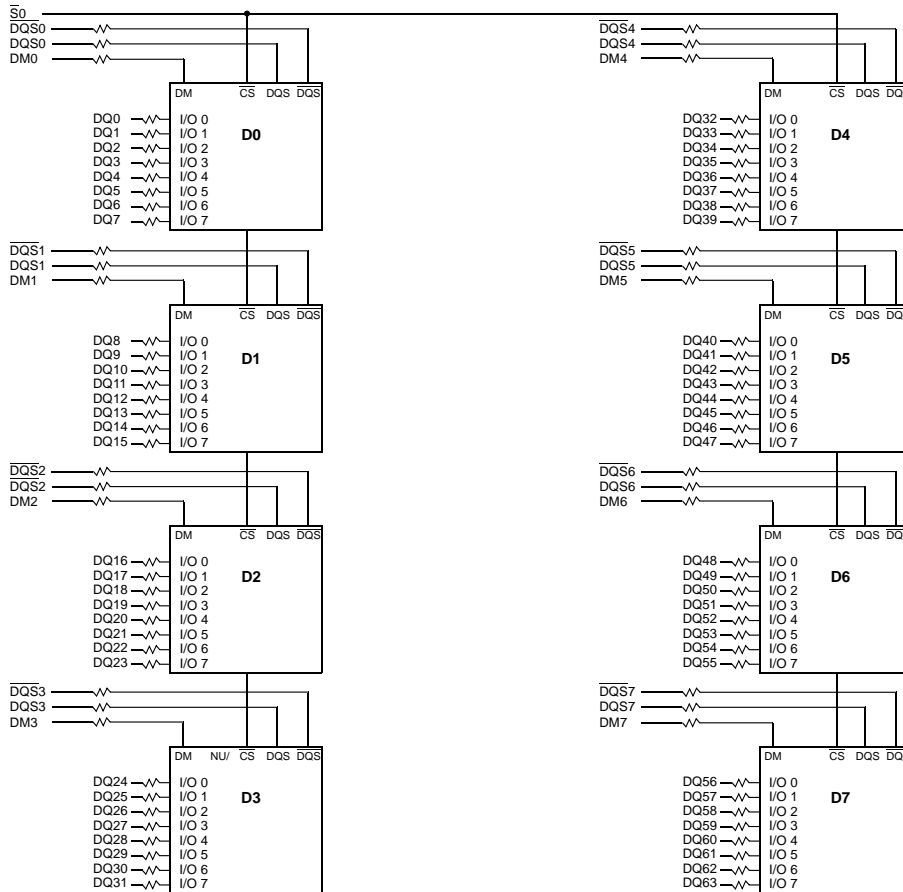

- BA0 - BA1 → BA0-BA1 : DDR2 SDRAMs D0 - D7
- A0 - A13 → A0-A13 : DDR2 SDRAMs D0 - D7
- RAS → RAS : DDR2 SDRAMs D0 - D7
- CAS → CAS : DDR2 SDRAMs D0 - D7
- CKE0 → CKE : DDR2 SDRAMs D0 - D7
- WE → WE : DDR2 SDRAMs D0 - D7
- ODT0 → ODT : DDR2 SDRAMs D0 - D7

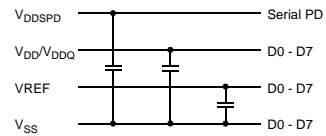

* Clock Wiring	
Clock Input	DDR2 SDRAMs
*CK0/CK0	2 DDR2 SDRAMs
*CK1/CK1	3 DDR2 SDRAMs
*CK2/CK2	3 DDR2 SDRAMs

\*Wire per Clock Loading Table/Wiring Diagrams

- Notes :**
1. DQ,DM, DQS/DQS resistors : 22 Ohms ± 5%.
  2. BAx, Ax, RAS, CAS, WE resistors : 5.1 Ohms ± 5%.

# 256MB,512MB,1GB Unbuffered DIMMs

# DDR2 SDRAM

## Functional Block Diagram: 512MB, 64Mx72 ECC Module (Populated as 1 rank of x8 DDR2 SDRAMs) M391T6553BG(Z)0

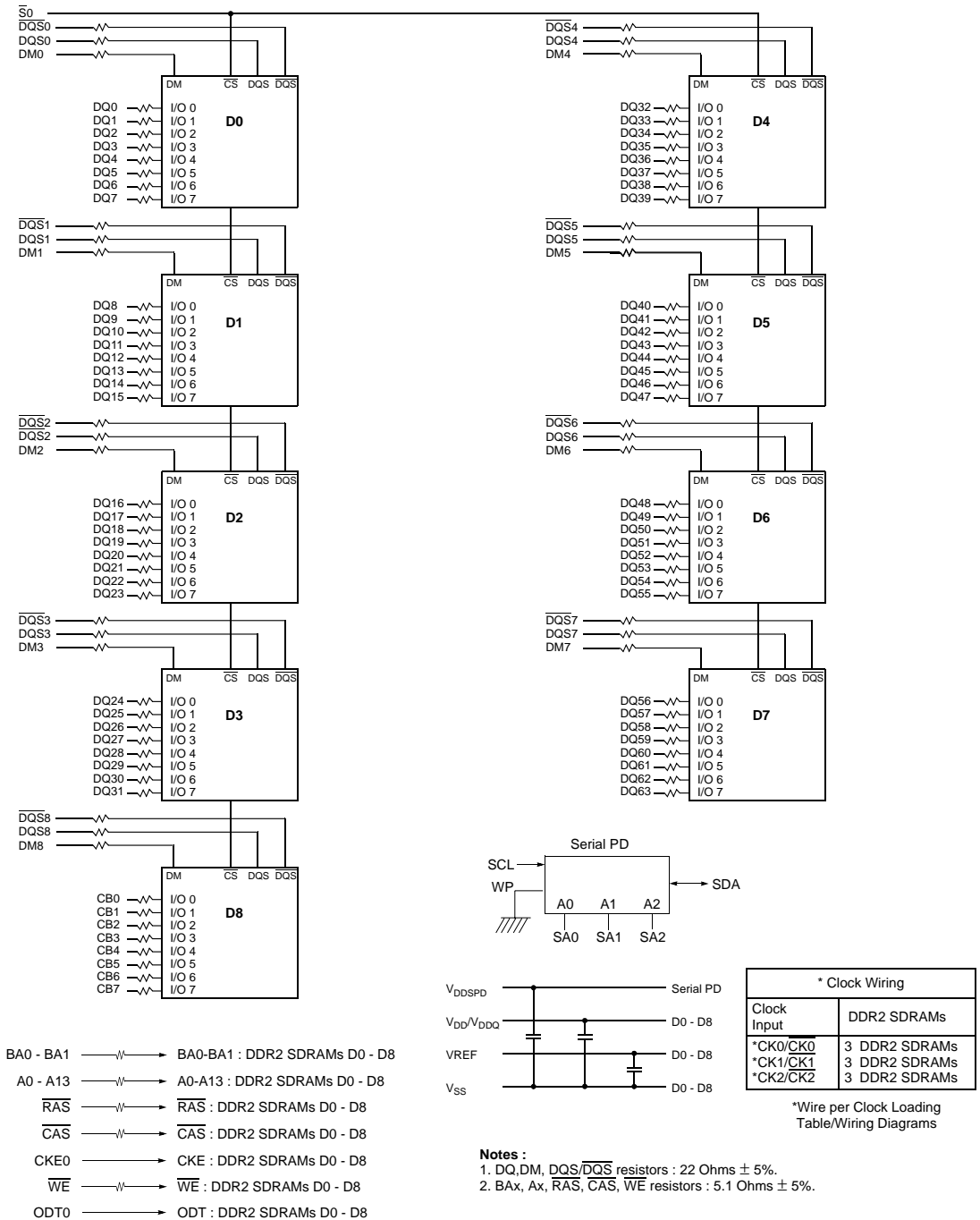

# 256MB,512MB,1GB Unbuffered DIMMs

# DDR2 SDRAM

## Functional Block Diagram: 1GB, 128Mx64 Module (Populated as 2 ranks of x8 DDR2 SDRAMs) M378T2953BG(Z)0

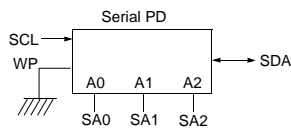
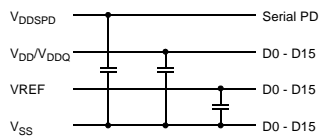
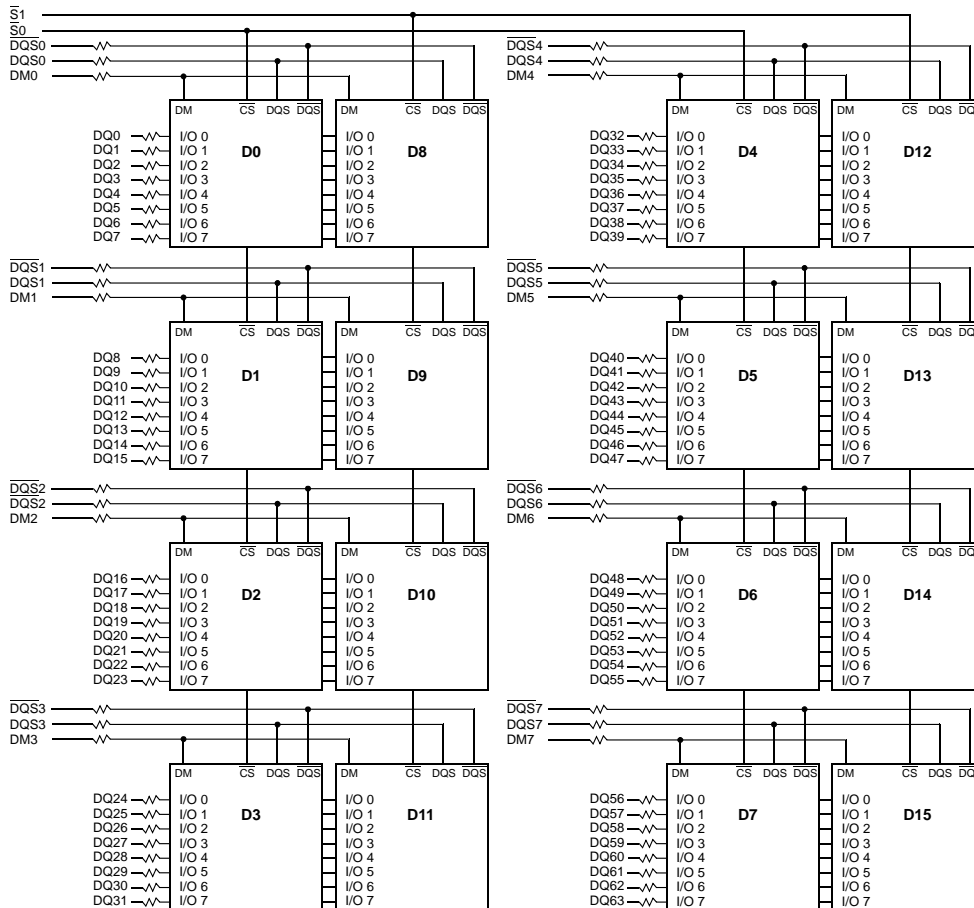

- BA0 - BA1 → BA0-BA1 : DDR2 SDRAMs D0 - D15
- A0 - A13 → A0-A13 : DDR2 SDRAMs D0 - D15
- CKE0 → CKE : DDR2 SDRAMs D0 - D7
- CKE1 → CKE : DDR2 SDRAMs D8 - D15
- RAS → RAS : DDR2 SDRAMs D0 - D15
- CAS → CAS : DDR2 SDRAMs D0 - D15
- WE → WE : DDR2 SDRAMs D0 - D15
- ODT0 → ODT : DDR2 SDRAMs D0 - D7
- ODT1 → ODT : DDR2 SDRAMs D8 - D15

* Clock Wiring	
Clock Input	DDR2 SDRAMs
*CK0/CK0	4 DDR2 SDRAMs
*CK1/CK1	6 DDR2 SDRAMs
*CK2/CK2	6 DDR2 SDRAMs

\*Wire per Clock Loading Table/Wiring Diagrams

### Notes :

1. DQ, DM, DQS/DQS resistors : 22 Ohms ± 5%.
2. BAx, Ax, RAS, CAS, WE resistors : 3 Ohms ± 5%.



# 256MB,512MB,1GB Unbuffered DIMMs

# DDR2 SDRAM

## Functional Block Diagram: 1GB, 128Mx72 ECC Module (Populated as 2 ranks of x8 DDR2 SDRAMs) M391T2953BG(Z)0

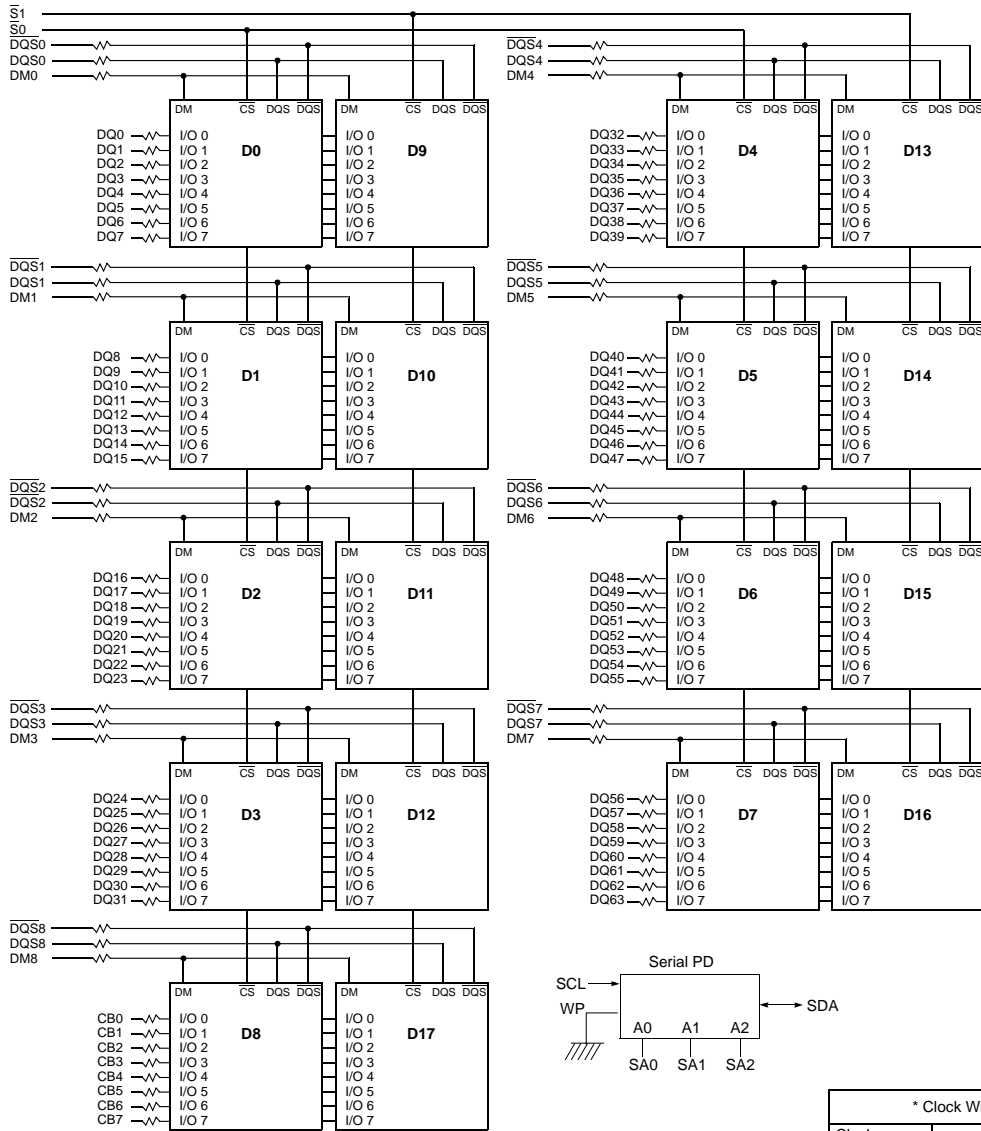

- BA0 - BA1 → BA0-BA1 : DDR2 SDRAMs D0 - D17
- A0 - A13 → A0-A13 : DDR2 SDRAMs D0 - D17
- CKE0 → CKE : DDR2 SDRAMs D0 - D8
- CKE1 → CKE : DDR2 SDRAMs D9 - D17
- RAS → RAS : DDR2 SDRAMs D0 - D17
- CAS → CAS : DDR2 SDRAMs D0 - D17
- WE → WE : DDR2 SDRAMs D0 - D17
- ODT0 → ODT : DDR2 SDRAMs D0 - D17
- ODT1 → ODT : DDR2 SDRAMs D9 - D17

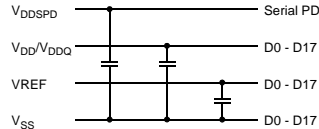

- Notes :**
1. DQ,DM, DQS/DQS resistors : 22 Ohms ± 5%.
  2. BAx, Ax, RAS, CAS, WE resistors : 3 Ohms ± 5%.

* Clock Wiring	
Clock Input	DDR2 SDRAMs
*CK0/CK0	6 DDR2 SDRAMs
*CK1/CK1	6 DDR2 SDRAMs
*CK2/CK2	6 DDR2 SDRAMs

\*Wire per Clock Loading Table/Wiring Diagrams

# 256MB,512MB,1GB Unbuffered DIMMs

# DDR2 SDRAM

## Functional Block Diagram: 256MB, 32Mx64 Module (Populated as 1 rank of x16 DDR2 SDRAMs) M378T3354BG(Z)0

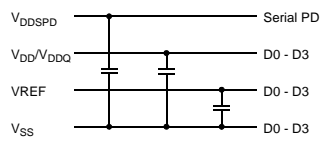
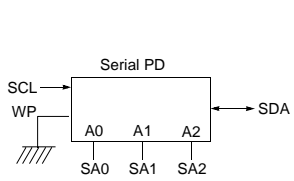
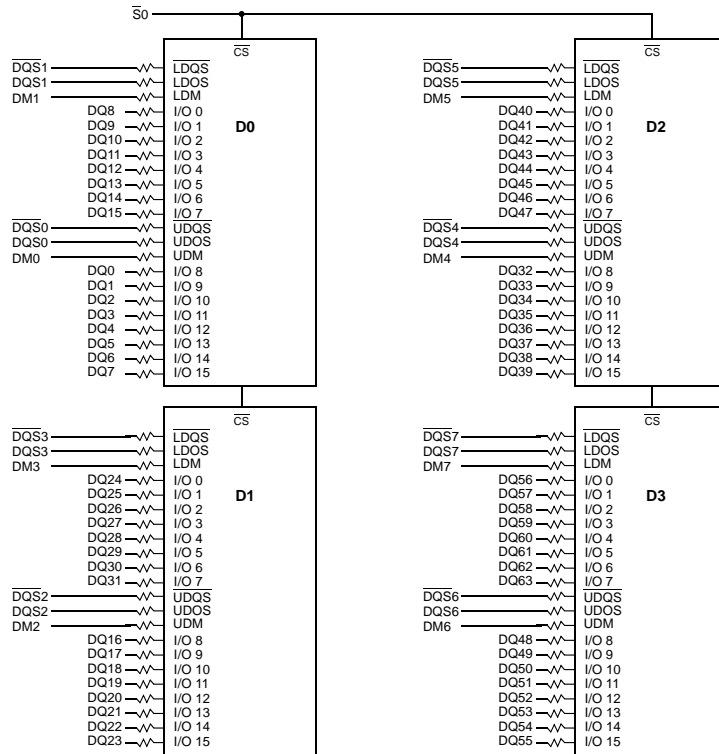

* Clock Wiring	
Clock Input	DDR2 SDRAMs
*CK0/CK0	NC
*CK1/CK1	2 DDR2 SDRAMs
*CK2/CK2	2 DDR2 SDRAMs

\*Wire per Clock Loading Table/Wiring Diagrams

- BA0 - BA1 → BA0-BA1 : DDR2 SDRAMs D0 - D3
- A0 - A12 → A0-A12 : DDR2 SDRAMs D0 - D3
- CKE0 → CKE : DDR2 SDRAMs D0 - D3
- RAS → RAS : DDR2 SDRAMs D0 - D3
- CAS → CAS : DDR2 SDRAMs D0 - D3
- WE → WE : DDR2 SDRAMs D0 - D3
- ODT0 → ODT : DDR2 SDRAMs D0 - D3

**Notes :**  
 1. DQ,DM, DQS/DQS resistors : 22 Ohms ± 5%.  
 4. BAx, Ax, RAS, CAS, WE resistors : 10 Ohms ± 5%.

## Absolute Maximum DC Ratings

Symbol	Parameter	Rating	Units	Notes
VDD	Voltage on VDD pin relative to Vss	- 1.0 V ~ 2.3 V	V	1
VDDQ	Voltage on VDDQ pin relative to Vss	- 0.5 V ~ 2.3 V	V	1
VDDL	Voltage on VDDL pin relative to Vss	- 0.5 V ~ 2.3 V	V	1
V <sub>IN</sub> , V <sub>OUT</sub>	Voltage on any pin relative to Vss	- 0.5 V ~ 2.3 V	V	1
T <sub>STG</sub>	Storage Temperature	-55 to +100	°C	1, 2

- Stresses greater than those listed under "Absolute Maximum Ratings" may cause permanent damage to the device. This is a stress rating only and functional operation of the device at these or any other conditions above those indicated in the operational sections of this specification is not implied. Exposure to absolute maximum rating conditions for extended periods may affect reliability.
- Storage Temperature is the case surface temperature on the center/top side of the DRAM. For the measurement conditions, please refer to JESD51-2 standard.

## AC &amp; DC Operating Conditions

## Recommended DC Operating Conditions (SSTL - 1.8)

Symbol	Parameter	Rating			Units	Notes
		Min.	Typ.	Max.		
VDD	Supply Voltage	1.7	1.8	1.9	V	
VDDL	Supply Voltage for DLL	1.7	1.8	1.9	V	4
VDDQ	Supply Voltage for Output	1.7	1.8	1.9	V	4
VREF	Input Reference Voltage	0.49*VDDQ	0.50*VDDQ	0.51*VDDQ	mV	1,2
VTT	Termination Voltage	VREF-0.04	VREF	VREF+0.04	V	3

There is no specific device VDD supply voltage requirement for SSTL-1.8 compliance. However under all conditions VDDQ must be less than or equal to VDD.

- The value of VREF may be selected by the user to provide optimum noise margin in the system. Typically the value of VREF is expected to be about 0.5 x VDDQ of the transmitting device and VREF is expected to track variations in VDDQ.
- Peak to peak AC noise on VREF may not exceed +/-2% VREF(DC).
- VTT of transmitting device must track VREF of receiving device.
- AC parameters are measured with VDD, VDDQ and VDDL tied together.

Operating Temperature Condition

Symbol	Parameter	Rating	Units	Notes
TOPER	Operating Temperature	0 to 95	°C	1, 2, 3

1. Operating Temperature is the case surface temperature on the center/top side of the DRAM. For the measurement conditions, please refer to JESD51.2 standard.
2. At 0 - 85 °C, operation temperature range are the temperature which all DRAM specification will be supported.
3. At 85 - 95 °C operation temperature range, doubling refresh commands in frequency to a 32ms period ( tREFI=3.9 us ) is required, and to enter to self refresh mode at this temperature range, an EMRS command is required to change internal refresh rate.

Input DC Logic Level

Symbol	Parameter	Min.	Max.	Units	Notes
V <sub>IH</sub> (DC)	DC input logic high	VREF + 0.125	VDDQ + 0.3	V	
V <sub>IL</sub> (DC)	DC input logic low	- 0.3	VREF - 0.125	V	

Input AC Logic Level

Symbol	Parameter	Min.	Max.	Units	Notes
V <sub>IH</sub> (AC)	AC input logic high	VREF + 0.250	-	V	
V <sub>IL</sub> (AC)	AC input logic low	-	VREF - 0.250	V	

AC Input Test Conditions

Symbol	Condition	Value	Units	Notes
V <sub>REF</sub>	Input reference voltage	0.5 * V <sub>DDQ</sub>	V	1
V <sub>SWING(MAX)</sub>	Input signal maximum peak to peak swing	1.0	V	1
SLEW	Input signal minimum slew rate	1.0	V/ns	2, 3

Notes:

1. Input waveform timing is referenced to the input signal crossing through the V<sub>IH/IL</sub>(AC) level applied to the device under test.
2. The input signal minimum slew rate is to be maintained over the range from V<sub>REF</sub> to V<sub>IH</sub>(AC) min for rising edges and the range from V<sub>REF</sub> to V<sub>IL</sub>(AC) max for falling edges as shown in the below figure.
3. AC timings are referenced with input waveforms switching from V<sub>IL</sub>(AC) to V<sub>IH</sub>(AC) on the positive transitions and V<sub>IH</sub>(AC) to V<sub>IL</sub>(AC) on the negative transitions.

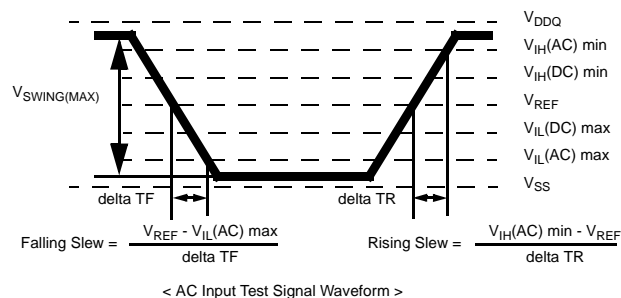

## IDD Specification Parameters Definition

(IDD values are for full operating range of Voltage and Temperature)

Symbol	Proposed Conditions	Units	Notes
IDD0	<b>Operating one bank active-precharge current;</b> $t_{CK} = t_{CK}(IDD)$ , $t_{RC} = t_{RC}(IDD)$ , $t_{RAS} = t_{RASmin}(IDD)$ ; CKE is HIGH, CS\ is HIGH between valid commands; Address bus inputs are SWITCHING; Data bus inputs are SWITCHING	mA	
IDD1	<b>Operating one bank active-read-precharge current;</b> $I_{OUT} = 0mA$ ; $BL = 4$ , $CL = CL(IDD)$ , $AL = 0$ ; $t_{CK} = t_{CK}(IDD)$ , $t_{RC} = t_{RC}(IDD)$ , $t_{RAS} = t_{RASmin}(IDD)$ , $t_{RCD} = t_{RCD}(IDD)$ ; CKE is HIGH, CS\ is HIGH between valid commands; Address bus inputs are SWITCHING; Data pattern is same as IDD4W	mA	
IDD2P	<b>Precharge power-down current;</b> All banks idle; $t_{CK} = t_{CK}(IDD)$ ; CKE is LOW; Other control and address bus inputs are STABLE; Data bus inputs are FLOATING	mA	
IDD2Q	<b>Precharge quiet standby current;</b> All banks idle; $t_{CK} = t_{CK}(IDD)$ ; CKE is HIGH, CS\ is HIGH; Other control and address bus inputs are STABLE; Data bus inputs are FLOATING	mA	
IDD2N	<b>Precharge standby current;</b> All banks idle; $t_{CK} = t_{CK}(IDD)$ ; CKE is HIGH, CS\ is HIGH; Other control and address bus inputs are SWITCHING; Data bus inputs are SWITCHING	mA	
IDD3P	<b>Active power-down current;</b> All banks open; $t_{CK} = t_{CK}(IDD)$ ; CKE is LOW; Other control and address bus inputs are STABLE; Data bus inputs are FLOATING	Fast PDN Exit MRS(12) = 0mA	mA
		Slow PDN Exit MRS(12) = 1mA	mA
IDD3N	<b>Active standby current;</b> All banks open; $t_{CK} = t_{CK}(IDD)$ , $t_{RAS} = t_{RASmax}(IDD)$ , $t_{RP} = t_{RP}(IDD)$ ; CKE is HIGH, CS\ is HIGH between valid commands; Other control and address bus inputs are SWITCHING; Data bus inputs are SWITCHING	mA	
IDD4W	<b>Operating burst write current;</b> All banks open, Continuous burst writes; $BL = 4$ , $CL = CL(IDD)$ , $AL = 0$ ; $t_{CK} = t_{CK}(IDD)$ , $t_{RAS} = t_{RASmax}(IDD)$ , $t_{RP} = t_{RP}(IDD)$ ; CKE is HIGH, CS\ is HIGH between valid commands; Address bus inputs are SWITCHING; Data bus inputs are SWITCHING	mA	
IDD4R	<b>Operating burst read current;</b> All banks open, Continuous burst reads, $I_{OUT} = 0mA$ ; $BL = 4$ , $CL = CL(IDD)$ , $AL = 0$ ; $t_{CK} = t_{CK}(IDD)$ , $t_{RAS} = t_{RASmax}(IDD)$ , $t_{RP} = t_{RP}(IDD)$ ; CKE is HIGH, CS\ is HIGH between valid commands; Address bus inputs are SWITCHING; Data pattern is same as IDD4W	mA	
IDD5B	<b>Burst auto refresh current;</b> $t_{CK} = t_{CK}(IDD)$ ; Refresh command at every $t_{RFC}(IDD)$ interval; CKE is HIGH, CS\ is HIGH between valid commands; Other control and address bus inputs are SWITCHING; Data bus inputs are SWITCHING	mA	
IDD6	<b>Self refresh current;</b> CK and CK\ at 0V; $CKE \leq 0.2V$ ; Other control and address bus inputs are FLOATING; Data bus inputs are FLOATING	Normal	mA
		Low Power	mA
IDD7	<b>Operating bank interleave read current;</b> All bank interleaving reads, $I_{OUT} = 0mA$ ; $BL = 4$ , $CL = CL(IDD)$ , $AL = t_{RCD}(IDD) - 1 * t_{CK}(IDD)$ ; $t_{CK} = t_{CK}(IDD)$ , $t_{RC} = t_{RC}(IDD)$ , $t_{RRD} = t_{RRD}(IDD)$ , $t_{RCD} = 1 * t_{CK}(IDD)$ ; CKE is HIGH, CS\ is HIGH between valid commands; Address bus inputs are STABLE during DESELECTs; Data pattern is same as IDD4R; Refer to the following page for detailed timing conditions	mA	

## 256MB,512MB,1GB Unbuffered DIMMs

## DDR2 SDRAM

### Operating Current Table(1-1) (T<sub>A</sub>=0°C, VDD= 1.9V)

#### M378T6553BG(Z)0 : 512MB(64Mx8 \*8) Module

Symbol	D5 (DDR2-533@CL=4)	CC (DDR2-400@CL=3)	Unit	Notes
IDD0	800	760	mA	
IDD1	880	800	mA	
IDD2P	64	64	mA	
IDD2Q	200	200	mA	
IDD2N	240	240	mA	
IDD3P-F	240	240	mA	
IDD3P-S	120	120	mA	
IDD3N	560	520	mA	
IDD4W	1,600	1,160	mA	
IDD4R	1,440	1,160	mA	
IDD5B	1,560	1,480	mA	
IDD6	Normal	44	44	mA
IDD7	2,200	2,160	mA	

\* Module IDD was calculated on the basis of component IDD and can be differently measured according to DQ loading cap.

#### M378T2953BG(Z)0 : 1GB(64Mx8 \*16) Module

Symbol	D5 (DDR2-533@CL=4)	CC (DDR2-400@CL=3)	Unit	Notes
IDD0	1,360	1,280	mA	
IDD1	1,440	1,320	mA	
IDD2P	128	128	mA	
IDD2Q	400	400	mA	
IDD2N	480	480	mA	
IDD3P-F	480	480	mA	
IDD3P-S	240	240	mA	
IDD3N	1,120	1,040	mA	
IDD4W	2,160	1,680	mA	
IDD4R	2,000	1,680	mA	
IDD5B	2,120	2,000	mA	
IDD6	Normal	88	88	mA
IDD7	2,760	2,680	mA	

\* Module IDD was calculated on the basis of component IDD and can be differently measured according to DQ loading cap.

## 256MB,512MB,1GB Unbuffered DIMMs

## DDR2 SDRAM

### Operating Current Table(1-2) (T<sub>A</sub>=0°C, VDD= 1.9V)

#### M378T3354BG(Z)0 : 256MB(32Mx16 \*4) Module

Symbol	D5 (DDR2-533@CL=4)	CC (DDR2-400@CL=3)	Unit	Notes
IDD0	480	460	mA	
IDD1	580	500	mA	
IDD2P	32	32	mA	
IDD2Q	100	100	mA	
IDD2N	120	120	mA	
IDD3P-F	120	120	mA	
IDD3P-S	60	60	mA	
IDD3N	280	260	mA	
IDD4W	920	740	mA	
IDD4R	820	680	mA	
IDD5B	780	740	mA	
IDD6	Normal	22	22	mA
IDD7	1,560	1,500	mA	

\* Module IDD was calculated on the basis of component IDD and can be differently measured according to DQ loading cap.

#### M391T6553BG(Z)0 : 512MB(64Mx8 \*9) ECC Module

Symbol	D5 (DDR2-533@CL=4)	CC (DDR2-400@CL=3)	Unit	Notes
IDD0	900	855	mA	
IDD1	990	900	mA	
IDD2P	72	72	mA	
IDD2Q	225	225	mA	
IDD2N	270	270	mA	
IDD3P-F	270	270	mA	
IDD3P-S	135	135	mA	
IDD3N	630	585	mA	
IDD4W	1,800	1,305	mA	
IDD4R	1,620	1,305	mA	
IDD5B	1,755	1,665	mA	
IDD6	Normal	50	50	mA
IDD7	2,475	2,430	mA	

\* Module IDD was calculated on the basis of component IDD and can be differently measured according to DQ loading cap.

## 256MB,512MB,1GB Unbuffered DIMMs

## DDR2 SDRAM

### Operating Current Table(1-3) (TA=0°C, VDD= 1.9V)

#### M391T2953BG(Z)0 : 1GB(64Mx8 \*18) ECC Module

Symbol	D5 (DDR2-533@CL=4)	CC (DDR2-400@CL=3)	Unit	Notes
IDD0	1,530	1,440	mA	
IDD1	1,620	1,485	mA	
IDD2P	144	144	mA	
IDD2Q	450	450	mA	
IDD2N	540	540	mA	
IDD3P-F	540	540	mA	
IDD3P-S	270	270	mA	
IDD3N	1,260	1,170	mA	
IDD4W	2,430	1,890	mA	
IDD4R	2,250	1,890	mA	
IDD5B	2,385	2,250	mA	
IDD6	Normal	99	99	mA
IDD7	3,105	3,015	mA	

\* Module IDD was calculated on the basis of component IDD and can be differently measured according to DQ loading cap.

### Input/Output Capacitance (VDD=1.8V, VDDQ=1.8V, TA=25°C)

Parameter	Symbol	Min	Max	Min	Max	Min	Max	Units
<b>Non-ECC</b>		<b>M378T6553BG(Z)0</b>		<b>M378T2953BG(Z)0</b>		<b>M378T3354BG(Z)0</b>		
Input capacitance, CK and $\overline{CK}$	CCK0	-	24	-	26	-	22	pF
	CCK1	-	25	-	28	-	24	
	CCK2	-	25	-	28	-	24	
Input capacitance, CKE and $\overline{CS}$	CI1	-	42	-	42	-	34	
Input capacitance, Addr, $\overline{RAS}$ , $\overline{CAS}$ , $\overline{WE}$	CI2	-	42	-	42	-	34	
Input/output capacitance, DQ, DM, DQS, $\overline{DQS}$	CIO	-	6	-	10	-	6	
<b>ECC</b>		<b>M391T6553BG(Z)0</b>		<b>M391T2953BG(Z)0</b>				
Input capacitance, CK and $\overline{CK}$	CCK0	-	25	-	28			pF
	CCK1	-	25	-	28			
	CCK2	-	25	-	28			
Input capacitance, CKE and $\overline{CS}$	CI <sub>1</sub>	-	44	-	44			
Input capacitance, Addr, $\overline{RAS}$ , $\overline{CAS}$ , $\overline{WE}$	CI <sub>2</sub>	-	44	-	44			
Input/output capacitance, DQ, DM, DQS, $\overline{DQS}$	CIO	-	6	-	10			

Note: DM is internally loaded to match DQ and DQS identically.



## 256MB,512MB,1GB Unbuffered DIMMs

## DDR2 SDRAM

### Electrical Characteristics & AC Timing for DDR2-533/400 SDRAM

( $0\text{ }^{\circ}\text{C} \leq T_{\text{CASE}} \leq 95\text{ }^{\circ}\text{C}$ ;  $V_{\text{DDQ}} = 1.8\text{V} \pm 0.1\text{V}$ ;  $V_{\text{DD}} = 1.8\text{V} \pm 0.1\text{V}$ )

#### Refresh Parameters by Device Density

Parameter	Symbol	256Mb	512Mb	1Gb	2Gb	4Gb	Units
Refresh to active/Refresh command time	tRFC	75	105	127.5	195	tbd	ns
Average periodic refresh interval	tREFI	$0\text{ }^{\circ}\text{C} \leq T_{\text{CASE}} \leq 85\text{ }^{\circ}\text{C}$	7.8	7.8	7.8	7.8	$\mu\text{s}$
		$85\text{ }^{\circ}\text{C} < T_{\text{CASE}} \leq 95\text{ }^{\circ}\text{C}$	3.9	3.9	3.9	3.9	$\mu\text{s}$

#### Speed Bins and CL, tRCD, tRP, tRC and tRAS for Corresponding Bin

Speed	DDR2-533(D5)		DDR2-400(CC)		Units
	min	max	min	max	
Bin (CL - tRCD - tRP)	4 - 4 - 4		3 - 3 - 3		
tCK, CL=3	5	8	5	8	ns
tCK, CL=4	3.75	8	5	8	ns
tCK, CL=5	-	-	-	-	ns
tRCD	15		15		ns
tRP	15		15		ns
tRC	55		55		ns
tRAS	40	70000	40	70000	ns

#### Timing Parameters by Speed Grade

(Refer to notes for informations related to this table at the bottom)

Parameter	Symbol	DDR2-533		DDR2-400		Units	Notes
		min	max	min	max		
DQ output access time from CK/CK	tAC	-500	+500	-600	+600	ps	
DQS output access time from CK/CK	tDQSCK	-450	+450	-500	+500	ps	
CK high-level width	tCH	0.45	0.55	0.45	0.55	tCK	
CK low-level width	tCL	0.45	0.55	0.45	0.55	tCK	
CK half period	tHP	min(tCL, tCH)	x	min(tCL, tCH)	x	ps	20,21
Clock cycle time, CL=x	tCK	3750	8000	5000	8000	ps	24
DQ and DM input hold time	tDH	225	x	275	x	ps	15,16,17
DQ and DM input setup time	tDS	100	x	150	x	ps	15,16,17

## 256MB,512MB,1GB Unbuffered DIMMs

## DDR2 SDRAM

Parameter	Symbol	DDR2-533		DDR2-400		Units	Notes
		min	max	min	max		
Control & Address input pulse width for each input	tIPW	0.6	x	0.6	x	tCK	
DQ and DM input pulse width for each input	tDIPW	0.35	x	0.35	x	tCK	
Data-out high-impedance time from CK/CK	tHZ	x	tAC max	x	tAC max	ps	
DQS low-impedance time from CK/CK	tLZ(DQS)	tAC min	tAC max	tAC min	tAC max	ps	
DQ low-impedance time from CK/CK	tLZ(DQ)	2* tACmin	tAC max	2* tACmin	tAC max	ps	
DQS-DQ skew for DQS and associated DQ signals	tDQSQ	x	300	x	350	ps	
DQ hold skew factor	tQHS	x	400	x	450	ps	
DQ/DQS output hold time from DQS	tQH	tHP - tQHS	x	tHP - tQHS	x	ps	
Write command to first DQS latching transition	tDQSS	WL-0.25	WL+0.25	WL-0.25	WL+0.25	tCK	
DQS input high pulse width	tDQSH	0.35	x	0.35	x	tCK	
DQS input low pulse width	tDQSL	0.35	x	0.35	x	tCK	
DQS falling edge to CK setup time	tDSS	0.2	x	0.2	x	tCK	
DQS falling edge hold time from CK	tDSH	0.2	x	0.2	x	tCK	
Mode register set command cycle time	tMRD	2	x	2	x	tCK	
Write postamble	tWPST	0.4	0.6	0.4	0.6	tCK	
Write preamble	tWPRE	0.35	x	0.35	x	tCK	
Address and control input hold time	tIH	375	x	475	x	ps	
Address and control input setup time	tIS	250	x	350	x	ps	
Read preamble	tRPRE	0.9	1.1	0.9	1.1	tCK	
Read postamble	tRPST	0.4	0.6	0.4	0.6	tCK	
Active to active command period for 1KB page size products	tRRD	7.5	x	7.5	x	ns	
Active to active command period for 2KB page size products	tRRD	10	x	10	x	ns	
Four Activate Window for 1KB page size products	tFAW	37.5		37.5		ns	
Four Activate Window for 2KB page size products	tFAW	50		50		ns	
$\overline{\text{CAS}}$ to $\overline{\text{CAS}}$ command delay	tCCD	2		2		tCK	

## 256MB,512MB,1GB Unbuffered DIMMs

## DDR2 SDRAM

Parameter	Symbol	DDR2-533		DDR2-400		Units	Notes
		min	max	min	max		
Write recovery time	tWR	15	x	15	x	ns	
Auto precharge write recovery + precharge time	tDAL	tWR+tRP	x	tWR+tRP	x	tCK	
Internal write to read command delay	tWTR	7.5	x	10	x	ns	
Internal read to precharge command delay	tRTP	7.5		7.5		ns	
Exit self refresh to a non-read command	tXSNR	tRFC + 10		tRFC + 10		ns	
Exit self refresh to a read command	tXSRD	200		200		tCK	
Exit precharge power down to any non-read command	tXP	2	x	2	x	tCK	
Exit active power down to read command	tXARD	2	x	2	x	tCK	
Exit active power down to read command (Slow exit, Lower power)	tXARDS	6 - AL		6 - AL		tCK	
CKE minimum pulse width (high and low pulse width)	t'CKE	3		3		tCK	
ODT turn-on delay	t'AOND	2	2	2	2	tCK	
ODT turn-on	t'AON	tAC(min)	tAC(max)+1	tAC(min)	tAC(max)+1	ns	
ODT turn-on(Power-Down mode)	t'AONPD	tAC(min)+2	2tCK+tAC(max)+1	tAC(min)+2	2tCK+tAC(max)+1	ns	
ODT turn-off delay	t'AOFD	2.5	2.5	2.5	2.5	tCK	
ODT turn-off	t'AOF	tAC(min)	tAC(max)+0.6	tAC(min)	tAC(max)+0.6	ns	
ODT turn-off (Power-Down mode)	t'AOFPD	tAC(min)+2	2.5tCK+tAC(max)+1	tAC(min)+2	2.5tCK+tAC(max)+1	ns	
ODT to power down entry latency	t'ANPD	3		3		tCK	
ODT power down exit latency	t'AXPD	8		8		tCK	
OCD drive mode output delay	t'OIT	0	12	0	12	ns	
Minimum time clocks remains ON after CKE asynchronously drops LOW	tDelay	tIS+tCK+tIH		tIS+tCK+tIH		ns	

# 256MB,512MB,1GB Unbuffered DIMMs

# DDR2 SDRAM

Physical Dimensions: 64Mbx8 based 64Mx64/x72 Module(1 Rank)  
M378/91T6553BG(Z)0

Units : Millimeters

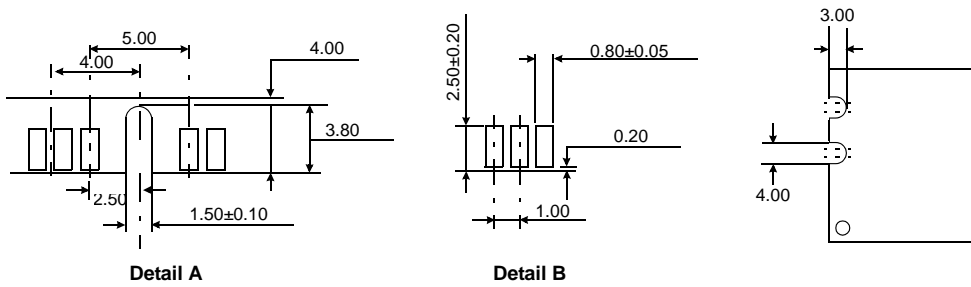
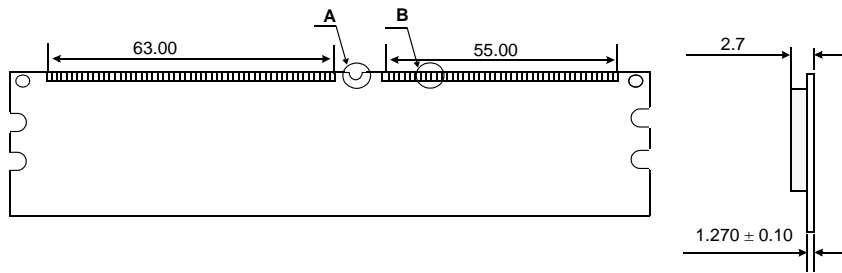
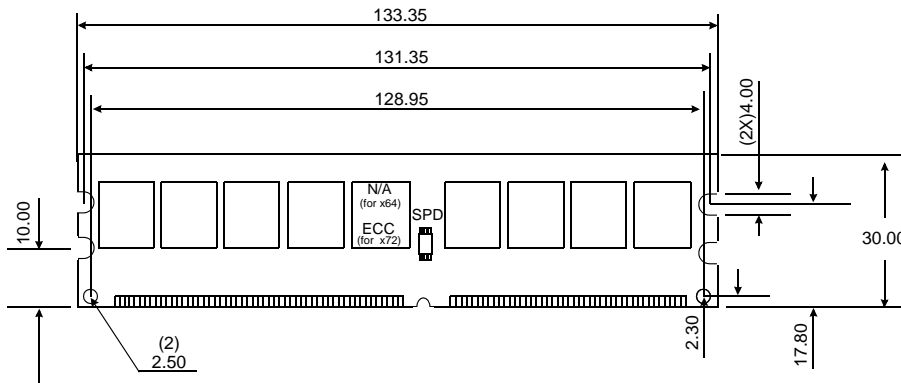

The used device is 64M x8 DDR2 SDRAM, FBGA.  
DDR2 SDRAM Part NO : K4T51083QB

# 256MB,512MB,1GB Unbuffered DIMMs

# DDR2 SDRAM

Physical Dimensions: 64Mbx8 based 128Mx64/x72 Module(2 Ranks)  
M378/91T2953BG(Z)0

Units : Millimeters

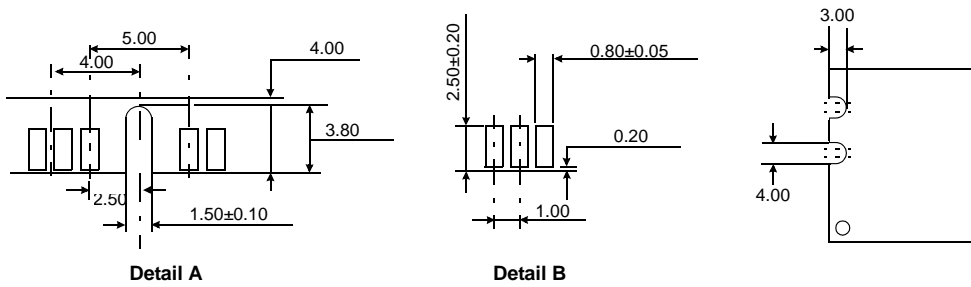
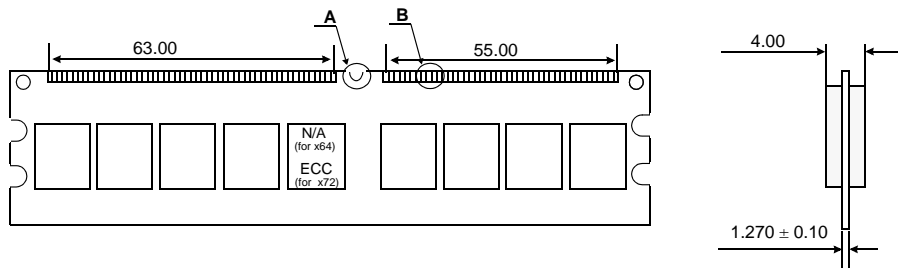
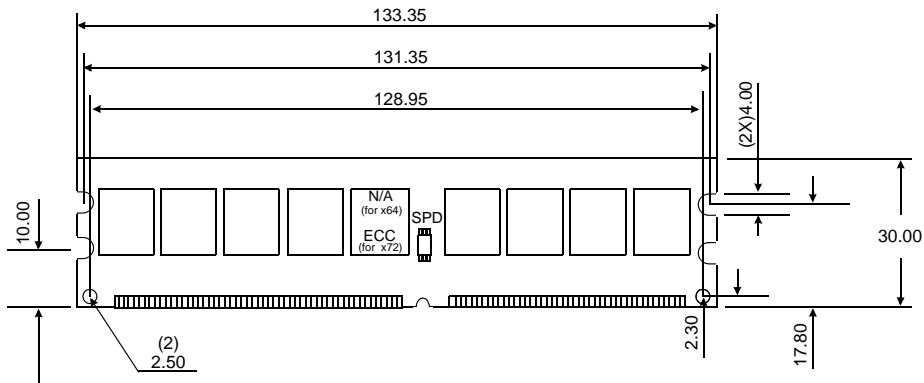

The used device is 64M x8 DDR2 SDRAM, FBGA.  
DDR2 SDRAM Part NO : K4T51083QB

**256MB,512MB,1GB Unbuffered DIMMs**

**DDR2 SDRAM**

**Physical Dimensions: 32Mbx16 based 32Mx64/x72 Module(1 Rank)  
M378T3354BG(Z)0**

Units : Millimeters

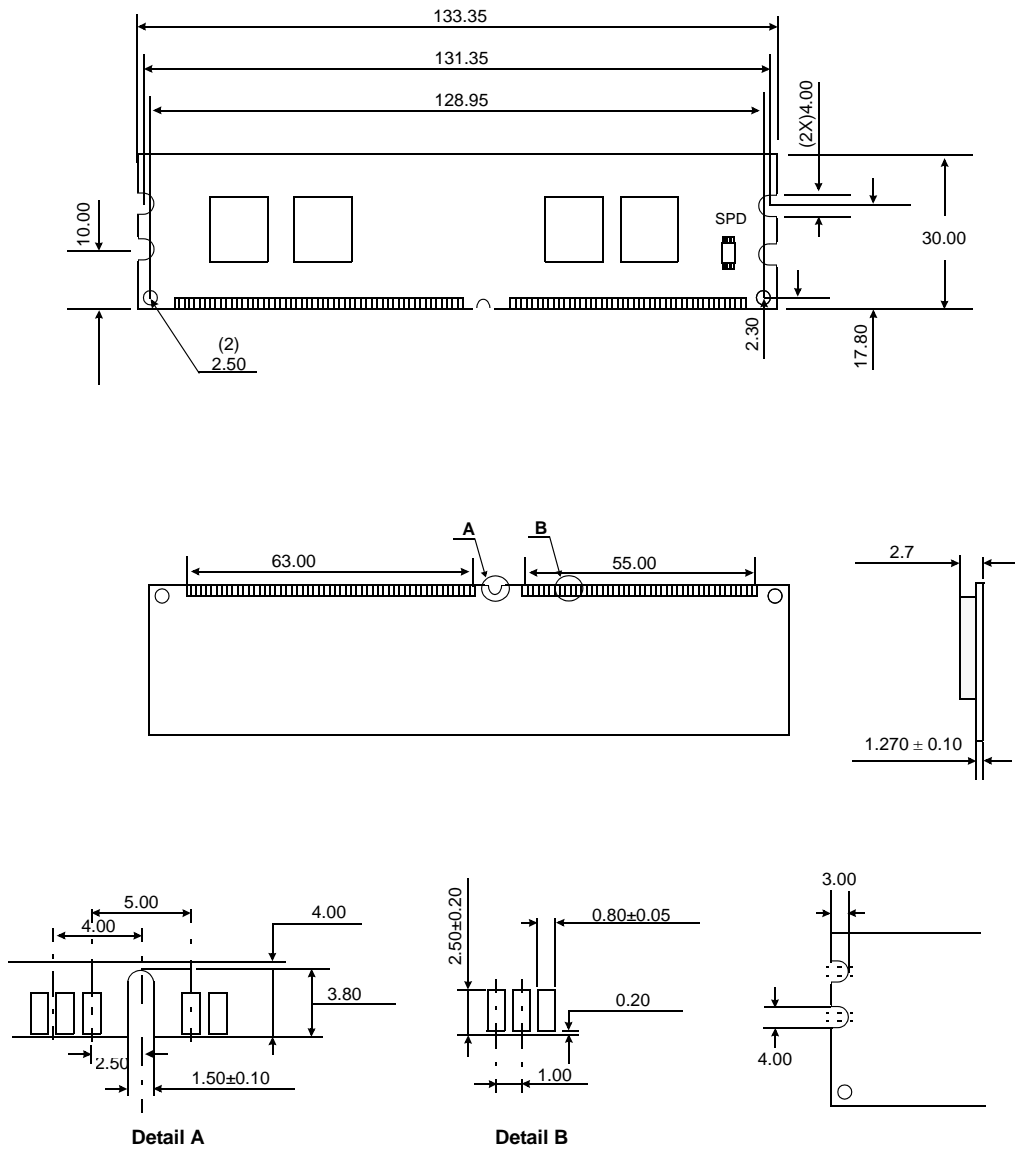

The used device is 32M x16 DDR2 SDRAM, FBGA.  
DDR2 SDRAM Part NO : K4T51163QB

**Revision History**

**Revision 1.0 (Jan. 2004)**

- Initial Release

**Revision 1.1 (Jun. 2004)**

- Added lead-free part number in the ordering information
- Changed IDD2P

**Revision 1.2 (Jan. 2005)**

- Removed DDR2-667 UDIMM