

M378T2863FBS
M378T5663FB3
M391T2863FB3
M391T5663FB3

240pin Unbuffered DIMM based on 1Gb F-die

60 & 84 FBGA with Lead-Free & Halogen-Free
(RoHS compliant)

datasheet

SAMSUNG ELECTRONICS RESERVES THE RIGHT TO CHANGE PRODUCTS, INFORMATION AND SPECIFICATIONS WITHOUT NOTICE.

Products and specifications discussed herein are for reference purposes only. All information discussed herein is provided on an "AS IS" basis, without warranties of any kind.

This document and all information discussed herein remain the sole and exclusive property of Samsung Electronics. No license of any patent, copyright, mask work, trademark or any other intellectual property right is granted by one party to the other party under this document, by implication, estoppel or otherwise.

Samsung products are not intended for use in life support, critical care, medical, safety equipment, or similar applications where product failure could result in loss of life or personal or physical harm, or any military or defense application, or any governmental procurement to which special terms or provisions may apply.

For updates or additional information about Samsung products, contact your nearest Samsung office.

All brand names, trademarks and registered trademarks belong to their respective owners.

© 2010 Samsung Electronics Co., Ltd. All rights reserved.

Revision History

<u>Revision No.</u>	<u>History</u>	<u>Draft Date</u>	<u>Remark</u>	<u>Editor</u>
1.0	- First Release.	Jul. 2010	-	S.H.Kim

Table Of Contents

240pin Unbuffered DIMM based on 1Gb F-die

1. DDR2 Unbuffered DIMM Ordering Information	4
2. Key Features	4
3. Address Configuration	4
4. Pin Configurations (Front side/Back side).....	5
5. x72 DIMM Pin Configurations (Front side/Back side)	6
6. Pin Description	6
7. Input/Output Function Description	7
8. Functional Block Diagram :	8
8.1 1GB, 128Mx64 Module - M378T2863FBS	8
8.2 1GB, 128Mx72 ECC Module - M391T2863FB3	9
8.3 2GB, 256Mx64 Module - M378T5663FB3	10
8.4 2GB, 256Mx72 ECC Module - M391T5663FB3	11
9. Absolute Maximum DC Ratings	12
10. AC & DC Operating Conditions	12
10.1 Recommended DC Operating Conditions (SSTL - 1.8).....	12
10.2 Operating Temperature Condition	13
10.3 Input DC Logic Level	13
10.4 Input AC Logic Level	13
10.5 AC Input Test Conditions.....	13
11. IDD Specification Parameters Definition	14
12. Operating Current Table :	15
12.1 M378T2863FBS : 1GB(128Mx8 *8) Module.....	15
12.2 M378T5663FB3 : 2GB(128Mx8 *16) Module	15
12.3 M391T2863FB3 : 1GB(128Mx8 *9) ECC Module.....	16
12.4 M391T5663FB3 : 2GB(128Mx8 *18) ECC Module.....	16
13. Input/Output Capacitance	17
14. Electrical Characteristics & AC Timing for DDR2-800/667	17
14.1 Refresh Parameters by Device Density.....	17
14.2 Speed Bins and CL, tRCD, tRP, tRC and tRAS for Corresponding Bin	17
14.3 Timing Parameters by Speed Grade	18
15. Physical Dimensions :	20
15.1 128Mbx8 based 128Mx64 Module (1 Rank).....	20
15.2 128Mbx8 based 128Mx72 Module (1 Rank).....	21



1. DDR2 Unbuffered DIMM Ordering Information

Part Number	Density	Organization	Component Composition	Number of Rank	Height
x64 Non ECC					
M378T2863FBS-CE7/F7/E6	1GB	128Mx64	128Mx8(K4T1G084QF)*8	1	30mm
M378T5663FB3-CE7/F7/E6	2GB	256Mx64	128Mx8(K4T1G084QF)*16	2	30mm
x72 ECC					
M391T2863FB3-CE7/F7/E6	1GB	128Mx72	128Mx8(K4T1G084QF)*9	1	30mm
M391T5663FB3-CE7/F7/E6	2GB	256Mx72	128Mx8(K4T1G084QF)*18	2	30mm

NOTE :

- "B" of Part number(11th digit) stands for Lead-Free, Halogen-Free, and RoHS compliant products.
- "3" of Part number(12th digit) stands for Dummy Pad PCB products.
- "S" of Part number(12th digit) stands for reduced layer PCB products.

2. Key Features

- Performance range

	E7 (DDR2-800)	F7 (DDR2-800)	E6 (DDR2-667)	Unit
CAS Latency	5	6	5	tCK
tRCD(min)	12.5	15	15	ns
tRP(min)	12.5	15	15	ns
tRC(min)	57.5	60	60	ns

- JEDEC standard $V_{DD} = 1.8V \pm 0.1V$ Power Supply
- $V_{DDQ} = 1.8V \pm 0.1V$
- 333MHz f_{CK} for 667Mb/sec/pin, 400MHz f_{CK} for 800Mb/sec/pin
- 8 Banks
- Posted \overline{CAS}
- Programmable \overline{CAS} Latency: 3, 4, 5, 6
- Programmable Additive Latency: 0, 1, 2, 3, 4, 5
- Write Latency(WL) = Read Latency(RL) - 1
- Burst Length: 4, 8(Interleave/Nibble sequential)
- Programmable Sequential / Interleave Burst Mode
- Bi-directional Differential Data-Strobe (Single-ended data-strobe is an optional feature)
- Off-Chip Driver(OCD) Impedance Adjustment
- On Die Termination with selectable values(50/75/150 ohms or disable)
- Average Refresh Period 7.8us at lower than a $T_{CASE} 85^{\circ}C$, 3.9us at $85^{\circ}C < T_{CASE} \leq 95^{\circ}C$
 - Support High Temperature Self-Refresh rate enable feature
- Package: 60ball FBGA - 128Mx8 and 84ball FBGA - 64Mx16
- All of base components are Lead-Free, Halogen-Free, and RoHS compliant

3. Address Configuration

Organization	Row Address	Column Address	Bank Address	Auto Precharge
128Mx8(1Gb) based Module	A0-A13	A0-A9	BA0-BA2	A10

4. Pin Configurations (Front side/Back side)

Pin	Front	Pin	Back	Pin	Front	Pin	Back	Pin	Front	Pin	Back	Pin	Front	Pin	Back
1	V _{REF}	121	V _{SS}	31	DQ19	151	V _{SS}	61	A4	181	V _{DDQ}	91	V _{SS}	211	DM5
2	V _{SS}	122	DQ4	32	V _{SS}	152	DQ28	62	V _{DDQ}	182	A3	92	DQS5	212	NC
3	DQ0	123	DQ5	33	DQ24	153	DQ29	63	A2	183	A1	93	DQS5	213	V _{SS}
4	DQ1	124	V _{SS}	34	DQ25	154	V _{SS}	64	V _{DD}	184	V _{DD}	94	V _{SS}	214	DQ46
5	V _{SS}	125	DM0	35	V _{SS}	155	DM3	KEY				95	DQ42	215	DQ47
6	DQS0	126	NC	36	DQS3	156	NC	65	V _{SS}	185	CK0	96	DQ43	216	V _{SS}
7	DQS0	127	V _{SS}	37	DQS3	157	V _{SS}	66	V _{SS}	186	CK0	97	V _{SS}	217	DQ52
8	V _{SS}	128	DQ6	38	V _{SS}	158	DQ30	67	V _{DD}	187	V _{DD}	98	DQ48	218	DQ53
9	DQ2	129	DQ7	39	DQ26	159	DQ31	68	NC	188	A0	99	DQ49	219	V _{SS}
10	DQ3	130	V _{SS}	40	DQ27	160	V _{SS}	69	V _{DD}	189	V _{DD}	100	V _{SS}	220	CK2
11	V _{SS}	131	DQ12	41	V _{SS}	161	NC	70	A10/AP	190	BA1	101	SA2	221	CK2
12	DQ8	132	DQ13	42	NC	162	NC	71	BA0	191	V _{DDQ}	102	NC, TEST ²	222	V _{SS}
13	DQ9	133	V _{SS}	43	NC	163	V _{SS}	72	V _{DDQ}	192	RAS	103	V _{SS}	223	DM6
14	V _{SS}	134	DM1	44	V _{SS}	164	NC	73	WE	193	S0	104	DQS6	224	NC
15	DQS1	135	NC	45	NC	165	NC	74	CAS	194	V _{DDQ}	105	DQS6	225	V _{SS}
16	DQS1	136	V _{SS}	46	NC	166	V _{SS}	75	V _{DDQ}	195	ODT0	106	V _{SS}	226	DQ54
17	V _{SS}	137	CK1	47	V _{SS}	167	NC	76	S1	196	A13 ¹	107	DQ50	227	DQ55
18	NC	138	CK1	48	NC	168	NC	77	ODT1	197	V _{DD}	108	DQ51	228	V _{SS}
19	NC	139	V _{SS}	49	NC	169	V _{SS}	78	V _{DDQ}	198	V _{SS}	109	V _{SS}	229	DQ60
20	V _{SS}	140	DQ14	50	V _{SS}	170	V _{DDQ}	79	V _{SS}	199	DQ36	110	DQ56	230	DQ61
21	DQ10	141	DQ15	51	V _{DDQ}	171	CKE1	80	DQ32	200	DQ37	111	DQ57	231	V _{SS}
22	DQ11	142	V _{SS}	52	CKE0	172	V _{DD}	81	DQ33	201	V _{SS}	112	V _{SS}	232	DM7
23	V _{SS}	143	DQ20	53	V _{DD}	173	NC	82	V _{SS}	202	DM4	113	DQS7	233	NC
24	DQ16	144	DQ21	54	BA2	174	NC	83	DQS4	203	NC	114	DQS7	234	V _{SS}
25	DQ17	145	V _{SS}	55	NC	175	V _{DDQ}	84	DQS4	204	V _{SS}	115	V _{SS}	235	DQ62
26	V _{SS}	146	DM2	56	V _{DDQ}	176	A12	85	V _{SS}	205	DQ38	116	DQ58	236	DQ63
27	DQS2	147	NC	57	A11	177	A9	86	DQ34	206	DQ39	117	DQ59	237	V _{SS}
28	DQS2	148	V _{SS}	58	A7	178	V _{DD}	87	DQ35	207	V _{SS}	118	V _{SS}	238	V _{DDSPD}
29	V _{SS}	149	DQ22	59	V _{DD}	179	A8	88	V _{SS}	208	DQ44	119	SDA	239	SA0
30	DQ18	150	DQ23	60	A5	180	A6	89	DQ40	209	DQ45	120	SCL	240	SA1
								90	DQ41	210	V _{SS}				

NOTE : NC = No Connect, RFU = Reserved for Future Use

1. Pin196(A13) is used for x4/x8 base Unbuffered DIMM.

2. The TEST pin is reserved for bus analysis tools and is not connected on standard memory module products (DIMMs.)

5. x72 DIMM Pin Configurations (Front side/Back side)

Pin	Front	Pin	Back	Pin	Front	Pin	Back	Pin	Front	Pin	Back	Pin	Front	Pin	Back
1	V _{REF}	121	V _{SS}	31	DQ19	151	V _{SS}	61	A4	181	V _{DDQ}	91	V _{SS}	211	DM5
2	V _{SS}	122	DQ4	32	V _{SS}	152	DQ28	62	V _{DDQ}	182	A3	92	DQS5	212	NC
3	DQ0	123	DQ5	33	DQ24	153	DQ29	63	A2	183	A1	93	DQS5	213	V _{SS}
4	DQ1	124	V _{SS}	34	DQ25	154	V _{SS}	64	V _{DD}	184	V _{DD}	94	V _{SS}	214	DQ46
5	V _{SS}	125	DM0	35	V _{SS}	155	DM3	KEY				95	DQ42	215	DQ47
6	DQS0	126	NC	36	DQS3	156	NC	65	V _{SS}	185	CK0	96	DQ43	216	V _{SS}
7	DQS0	127	V _{SS}	37	DQS3	157	V _{SS}	66	V _{SS}	186	CK0	97	V _{SS}	217	DQ52
8	V _{SS}	128	DQ6	38	V _{SS}	158	DQ30	67	V _{DD}	187	V _{DD}	98	DQ48	218	DQ53
9	DQ2	129	DQ7	39	DQ26	159	DQ31	68	NC	188	A0	99	DQ49	219	V _{SS}
10	DQ3	130	V _{SS}	40	DQ27	160	V _{SS}	69	V _{DD}	189	V _{DD}	100	V _{SS}	220	CK2
11	V _{SS}	131	DQ12	41	V _{SS}	161	CB4	70	A10/AP	190	BA1	101	SA2	221	CK2
12	DQ8	132	DQ13	42	CB0	162	CB5	71	BA0	191	V _{DDQ}	102	NC, TEST ²	222	V _{SS}
13	DQ9	133	V _{SS}	43	CB1	163	V _{SS}	72	V _{DDQ}	192	RAS	103	V _{SS}	223	DM6
14	V _{SS}	134	DM1	44	V _{SS}	164	DM8	73	WE	193	S0	104	DQS6	224	NC
15	DQS1	135	NC	45	DQS8	165	NC	74	CAS	194	V _{DDQ}	105	DQS6	225	V _{SS}
16	DQS1	136	V _{SS}	46	DQS8	166	V _{SS}	75	V _{DDQ}	195	ODT0	106	V _{SS}	226	DQ54
17	V _{SS}	137	CK1	47	V _{SS}	167	CB6	76	S1	196	A13	107	DQ50	227	DQ55
18	NC	138	CK1	48	CB2	168	CB7	77	ODT1	197	V _{DD}	108	DQ51	228	V _{SS}
19	NC	139	V _{SS}	49	CB3	169	V _{SS}	78	V _{DDQ}	198	V _{SS}	109	V _{SS}	229	DQ60
20	V _{SS}	140	DQ14	50	V _{SS}	170	V _{DDQ}	79	V _{SS}	199	DQ36	110	DQ56	230	DQ61
21	DQ10	141	DQ15	51	V _{DDQ}	171	CKE1	80	DQ32	200	DQ37	111	DQ57	231	V _{SS}
22	DQ11	142	V _{SS}	52	CKE0	172	V _{DD}	81	DQ33	201	V _{SS}	112	V _{SS}	232	DM7
23	V _{SS}	143	DQ20	53	V _{DD}	173	NC	82	V _{SS}	202	DM4	113	DQS7	233	NC
24	DQ16	144	DQ21	54	BA2	174	NC	83	DQS4	203	NC	114	DQS7	234	V _{SS}
25	DQ17	145	V _{SS}	55	NC	175	V _{DDQ}	84	DQS4	204	V _{SS}	115	V _{SS}	235	DQ62
26	V _{SS}	146	DM2	56	V _{DDQ}	176	A12	85	V _{SS}	205	DQ38	116	DQ58	236	DQ63
27	DQS2	147	NC	57	A11	177	A9	86	DQ34	206	DQ39	117	DQ59	237	V _{SS}
28	DQS2	148	V _{SS}	58	A7	178	V _{DD}	87	DQ35	207	V _{SS}	118	V _{SS}	238	V _{DDSPD}
29	V _{SS}	149	DQ22	59	V _{DD}	179	A8	88	V _{SS}	208	DQ44	119	SDA	239	SA0
30	DQ18	150	DQ23	60	A5	180	A6	89	DQ40	209	DQ45	120	SCL	240	SA1
								90	DQ41	210	V _{SS}				

NOTE : NC = No Connect, RFU = Reserved for Future Use
 1. Pin196(A13) is used for x4/x8 base Unbuffered DIMM.
 2. The TEST pin is reserved for bus analysis tools and is not connected on standard memory module products (DIMMs.)

6. Pin Description

Pin Name	Description	Pin Name	Description
A0-A13	DDR2 SDRAM address bus	CK0, CK1, CK2	DDR2 SDRAM clocks (positive line of differential pair)
BA0-BA2	DDR2 SDRAM bank select	CK0, CK1, CK2	DDR2 SDRAM clocks (negative line of differential pair)
RAS	DDR2 SDRAM row address strobe	SCL	I ² C serial bus clock for EEPROM
CAS	DDR2 SDRAM column address strobe	SDA	I ² C serial bus data line for EEPROM
WE	DDR2 SDRAM write enable	SA0-SA2	I ² C serial address select for EEPROM
S0, S1	DIMM Rank Select Lines	V _{DD} *	DDR2 SDRAM core power supply
CKE0,CKE1	DDR2 SDRAM clock enable lines	V _{DDQ} *	DDR2 SDRAM I/O Driver power supply
ODT0, ODT1	On-die termination control lines	V _{REF}	DDR2 SDRAM I/O reference supply
DQ0 - DQ63	DIMM memory data bus	V _{SS}	Power supply return (ground)
CB0 - CB7	DIMM ECC check bits	V _{DDSPD}	Serial EEPROM positive power supply
DQS0 - DQS8	DDR2 SDRAM data strobes	NC	Spare Pins(no connect)
DM(0-8)	DDR2 SDRAM data masks	RESET	Not used on UDIMM
DQS0-DQS8	DDR2 SDRAM differential data strobes	TEST	Used by memory bus analysis tools (unused on memory DIMMs)

NOTE : *The V_{DD} and V_{DDQ} pins are tied to the single power-plane on PCB.



7. Input/Output Function Description

Symbol	Type	Description
$\overline{CK0-CK2}$ $\overline{CK0-CK2}$	Input	CK and \overline{CK} are differential clock inputs. All the SDRAM addr/cntl inputs are sampled on the crossing of positive edge of CK and negative edge of \overline{CK} . Output (read) data is reference to the crossing of CK and \overline{CK} (Both directions of crossing)
CKE0-CKE1	Input	Activates the SDRAM CK signal when high and deactivates the CK Signal When low. By deactivating the clocks, CKE low initiates the Powe Down mode, or the Self-Refresh mode
$\overline{S0-S1}$	Input	Enables the associated SDRAM command decoder when low and disables the command decoder when high. When the command decoder is disabled, new command are ignored but previous operations continue. This signal provides for external rank selection on systems with multiple ranks
\overline{RAS} , \overline{CAS} , \overline{WE}	Input	\overline{RAS} , \overline{CAS} , and \overline{WE} (ALONG WITH CS) define the command being entered.
ODT0-ODT1	Input	When high, termination resistance is enabled for all DQ, \overline{DQ} and DM pins, assuming the function is enabled in the Extended Mode Register Set (EMRS).
V_{REF}	Supply	Reference voltage for SSTL 18 inputs.
V_{DDQ}	Supply	Power supply for the DDR II SDRAM output buffers to provide improved noise immunity. For all current DDR2 unbuffered DIMM designs, V_{DDQ} shares the same power plane as V_{DD} pins.
BA0-BA2	Input	Selects which SDRAM BANK of four is activated.
A0-A13	Input	During a Bank Activate command cycle, Address input defines the row address (RA0-RA13) During a Read or Write command cycle, Address input defines the column address, In addition to the column address, AP is used to invoke autoprecharge operation at the end of the burst read or write cycle. If AP is high, autoprecharge is selected and BA0-BA2 defines the bank to be precharged. If AP is low, autoprecharge is disabled. During a precharge command cycle, AP is used in conjunction with BA0-BA2 to control which bank(s) to precharge. If AP is high, all banks will be precharged regardless of the state of BA0-BA2. If AP is low, BA0, BA1, BA2 are used to define which bank to precharge.
DQ0-DQ63 CB0-CB7	In/Out	Data and Check Bit Input/Output pins.
DM0-DM8	Input	DM is an input mask signal for write data. Input data is masked when DM is sampled High coincident with that input data during a write access. DM is sampled on both edges of DQS. Although DM pins are input only, the DM loading matches the DQ and DQS loading.
V_{DD} , V_{SS}	Supply	Power and ground for DDR2 SDRAM input buffers, and core logic. V_{DD} and V_{DDQ} pins are tied to V_{DD}/V_{DDQ} planes on these modules.
$\overline{DQS0-DQS8}$ $\overline{DQS0-DQS8}$	In/Out	Data strobe for input and output data. For Rawcards using x16 orginized DRAMs DQ0-7 connect to the LDQS pin of the DRAMs and DQ8-17 connect to the UDQS pin of the DRAM
SA0-SA2	Input	These signals and tied at the system planar to either V_{SS} or V_{DD} to configure the serial SPD EERPOM address range.
SDA	In/Out	This bidirectional pin is used to transfer data into or out of the SPD EEPROM. A resistor must be connected from the SDA bus line to V_{DD} to act as a pullup on the system board.

8. Functional Block Diagram :

8.1 1GB, 128Mx64 Module - M378T2863FBS

(Populated as 1 rank of x8 DDR2 SDRAMs)

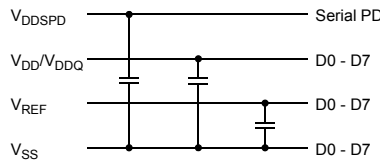
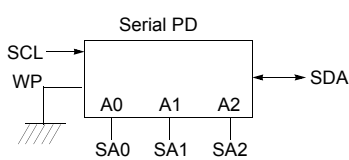
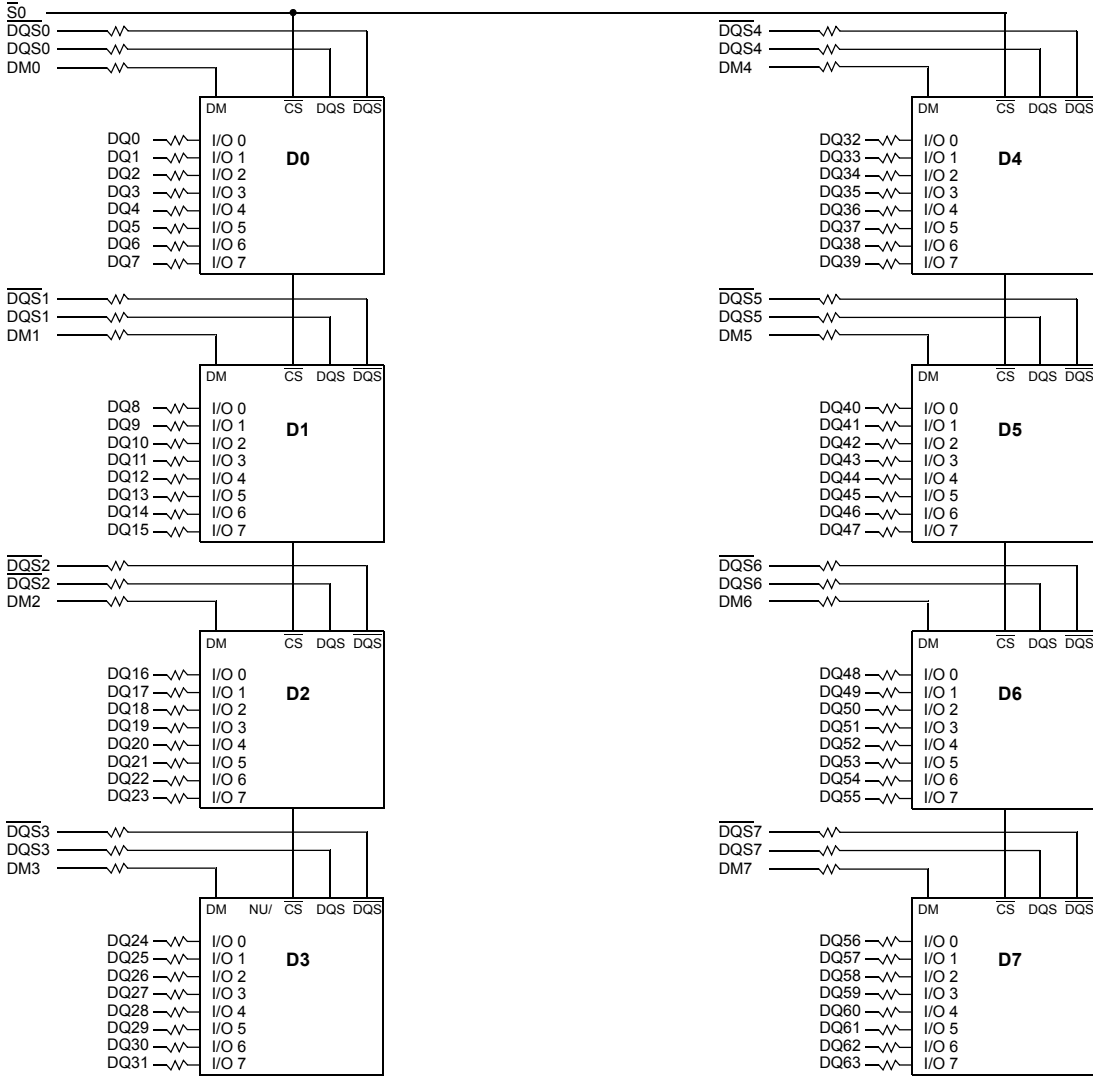

- BA0 - BA2 → BA0-BA2 : DDR2 SDRAMs D0 - D7
- A0 - A13 → A0-A13 : DDR2 SDRAMs D0 - D7
- $\overline{\text{RAS}}$ → $\overline{\text{RAS}}$: DDR2 SDRAMs D0 - D7
- $\overline{\text{CAS}}$ → $\overline{\text{CAS}}$: DDR2 SDRAMs D0 - D7
- CKE0 → CKE : DDR2 SDRAMs D0 - D7
- $\overline{\text{WE}}$ → $\overline{\text{WE}}$: DDR2 SDRAMs D0 - D7
- ODT0 → ODT : DDR2 SDRAMs D0 - D7

* Clock Wiring	
Clock Input	DDR2 SDRAMs
*CK0/ $\overline{\text{CK0}}$	2 DDR2 SDRAMs
*CK1/ $\overline{\text{CK1}}$	3 DDR2 SDRAMs
*CK2/ $\overline{\text{CK2}}$	3 DDR2 SDRAMs

*Wire per Clock Loading Table/Wiring Diagrams

NOTE :

1. DQ,DM, DQS/DQS resistors : 22 Ohms ± 5%.
2. BAX, Ax, RAS, CAS, WE resistors : 10 Ohms ± 5%.

8.2 1GB, 128Mx72 ECC Module - M391T2863FB3

(Populated as 1 rank of x8 DDR2 SDRAMs)

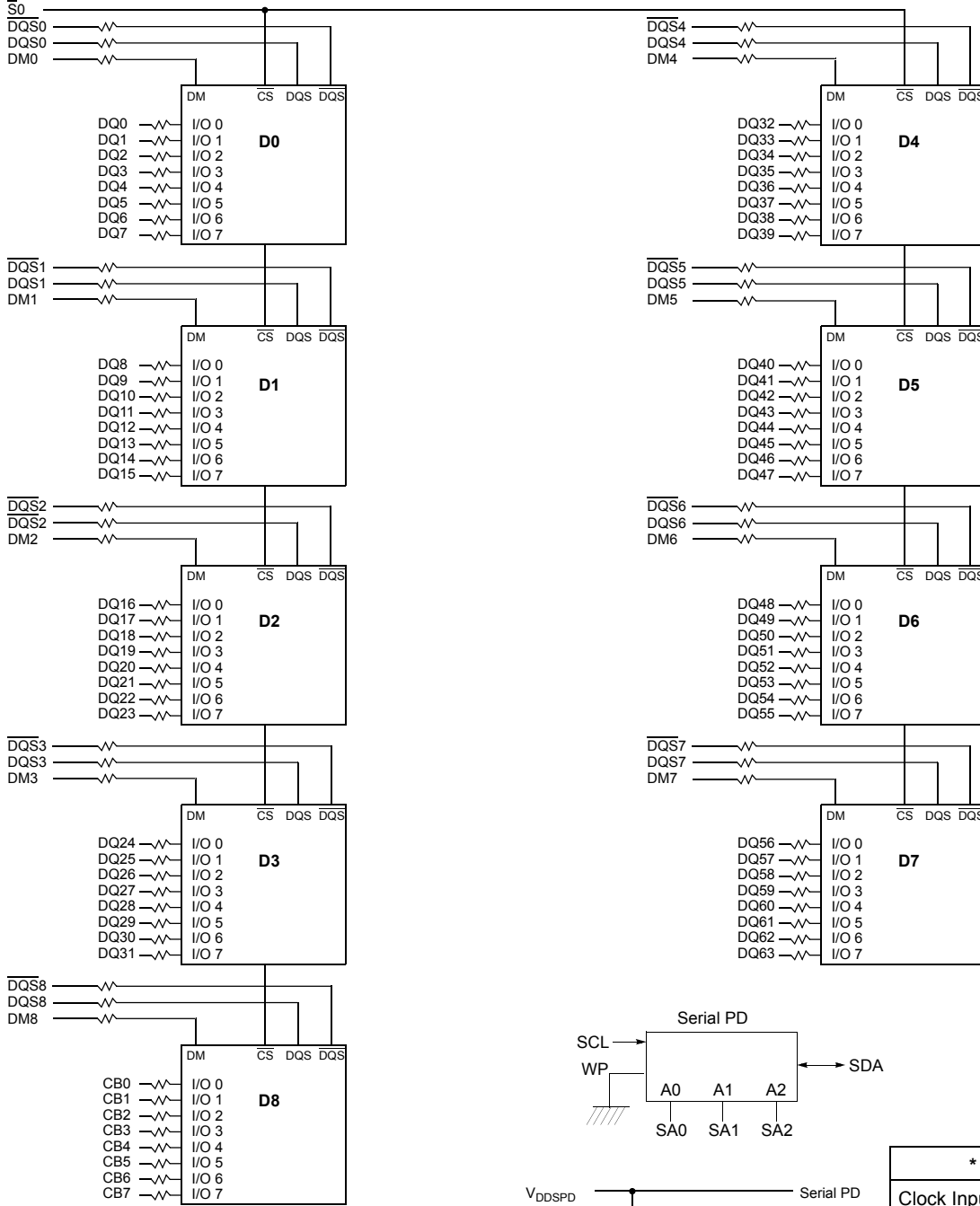

- BA0 - BA2 → BA0-BA2 : DDR2 SDRAMs D0 - D8
- A0 - A13 → A0-A13 : DDR2 SDRAMs D0 - D8
- $\overline{\text{RAS}}$ → $\overline{\text{RAS}}$: DDR2 SDRAMs D0 - D8
- $\overline{\text{CAS}}$ → $\overline{\text{CAS}}$: DDR2 SDRAMs D0 - D8
- CKE0 → CKE : DDR2 SDRAMs D0 - D8
- $\overline{\text{WE}}$ → $\overline{\text{WE}}$: DDR2 SDRAMs D0 - D8
- ODT0 → ODT : DDR2 SDRAMs D0 - D8

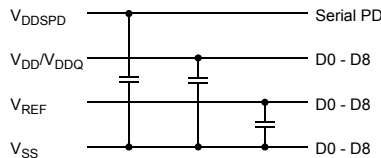
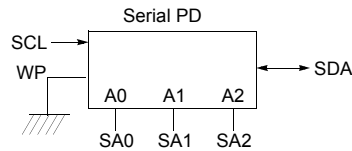

* Clock Wiring	
Clock Input	DDR2 SDRAMs
*CK0/ $\overline{\text{CK0}}$	3 DDR2 SDRAMs
*CK1/ $\overline{\text{CK1}}$	3 DDR2 SDRAMs
*CK2/ $\overline{\text{CK2}}$	3 DDR2 SDRAMs

*Wire per Clock Loading Table/Wiring Diagrams

NOTE :

1. DQ,DM, DQS/ $\overline{\text{DQS}}$ resistors : 22 Ohms \pm 5%.
2. BAx, Ax, $\overline{\text{RAS}}$, $\overline{\text{CAS}}$, $\overline{\text{WE}}$ resistors : 10 Ohms \pm 5%.

8.3 2GB, 256Mx64 Module - M378T5663FB3

(Populated as 2 ranks of x8 DDR2 SDRAMs)

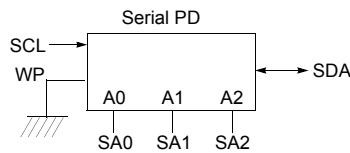
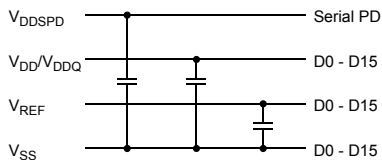
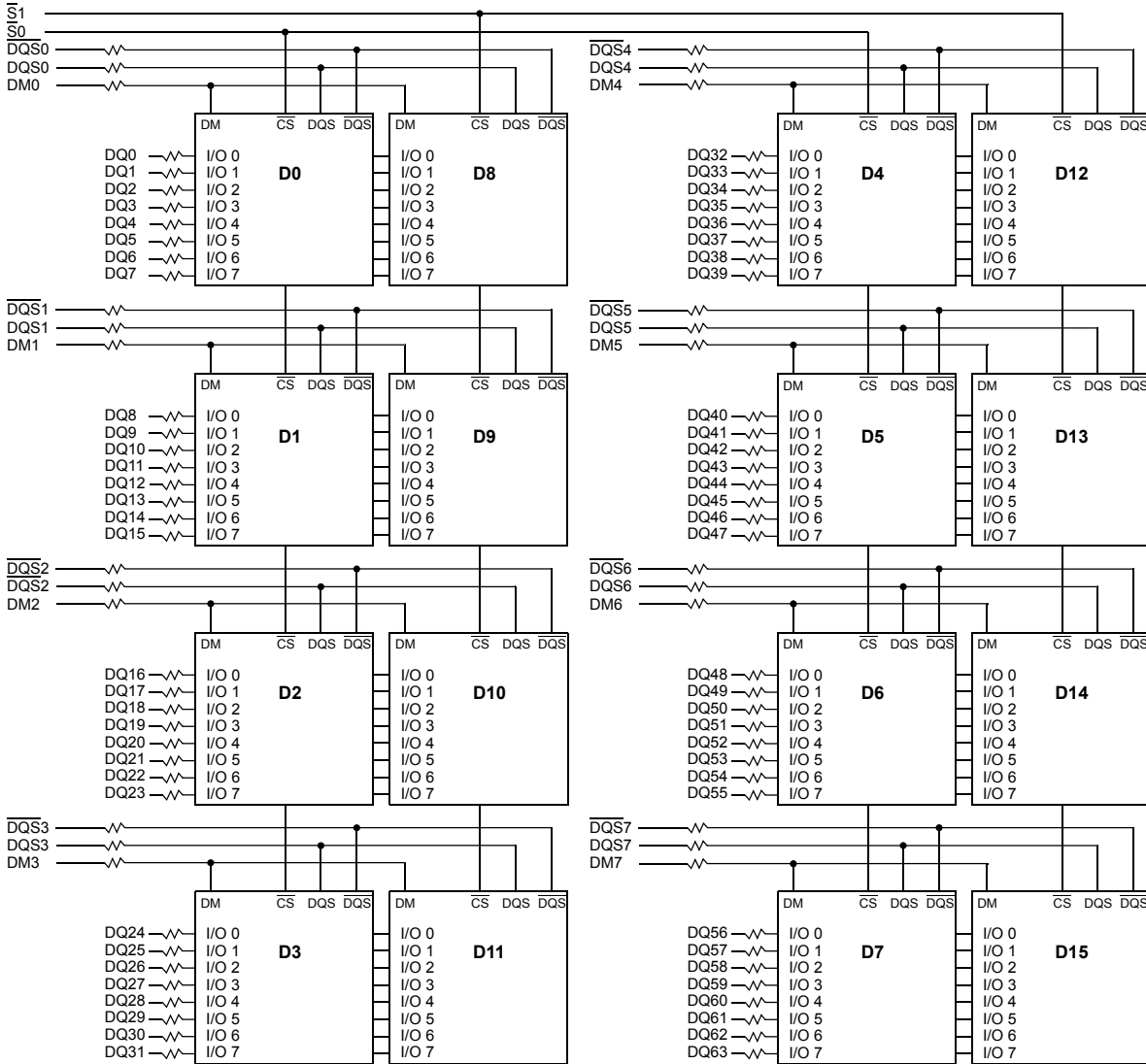

- BA0 - BA2 → BA0-BA2 : DDR2 SDRAMs D0 - D15
- A0 - A13 → A0-A13 : DDR2 SDRAMs D0 - D15
- CKE0 → CKE : DDR2 SDRAMs D0 - D7
- CKE1 → CKE : DDR2 SDRAMs D8 - D15
- $\overline{\text{RAS}}$ → $\overline{\text{RAS}}$: DDR2 SDRAMs D0 - D15
- $\overline{\text{CAS}}$ → $\overline{\text{CAS}}$: DDR2 SDRAMs D0 - D15
- $\overline{\text{WE}}$ → $\overline{\text{WE}}$: DDR2 SDRAMs D0 - D15
- ODT0 → ODT : DDR2 SDRAMs D0 - D7
- ODT1 → ODT : DDR2 SDRAMs D8 - D15

* Clock Wiring	
Clock Input	DDR2 SDRAMs
*CK0/ $\overline{\text{CK0}}$	4 DDR2 SDRAMs
*CK1/ $\overline{\text{CK1}}$	6 DDR2 SDRAMs
*CK2/ $\overline{\text{CK2}}$	6 DDR2 SDRAMs

*Wire per Clock Loading Table/Wiring Diagrams

- NOTE :**
- DQ, DM, DQS/DQS resistors : 22 Ohms ± 5%.
 - BAX, Ax, $\overline{\text{RAS}}$, $\overline{\text{CAS}}$, $\overline{\text{WE}}$ resistors : 7.5 Ohms ± 5%.



8.4 2GB, 256Mx72 ECC Module - M391T5663FB3

(Populated as 2 ranks of x8 DDR2 SDRAMs)

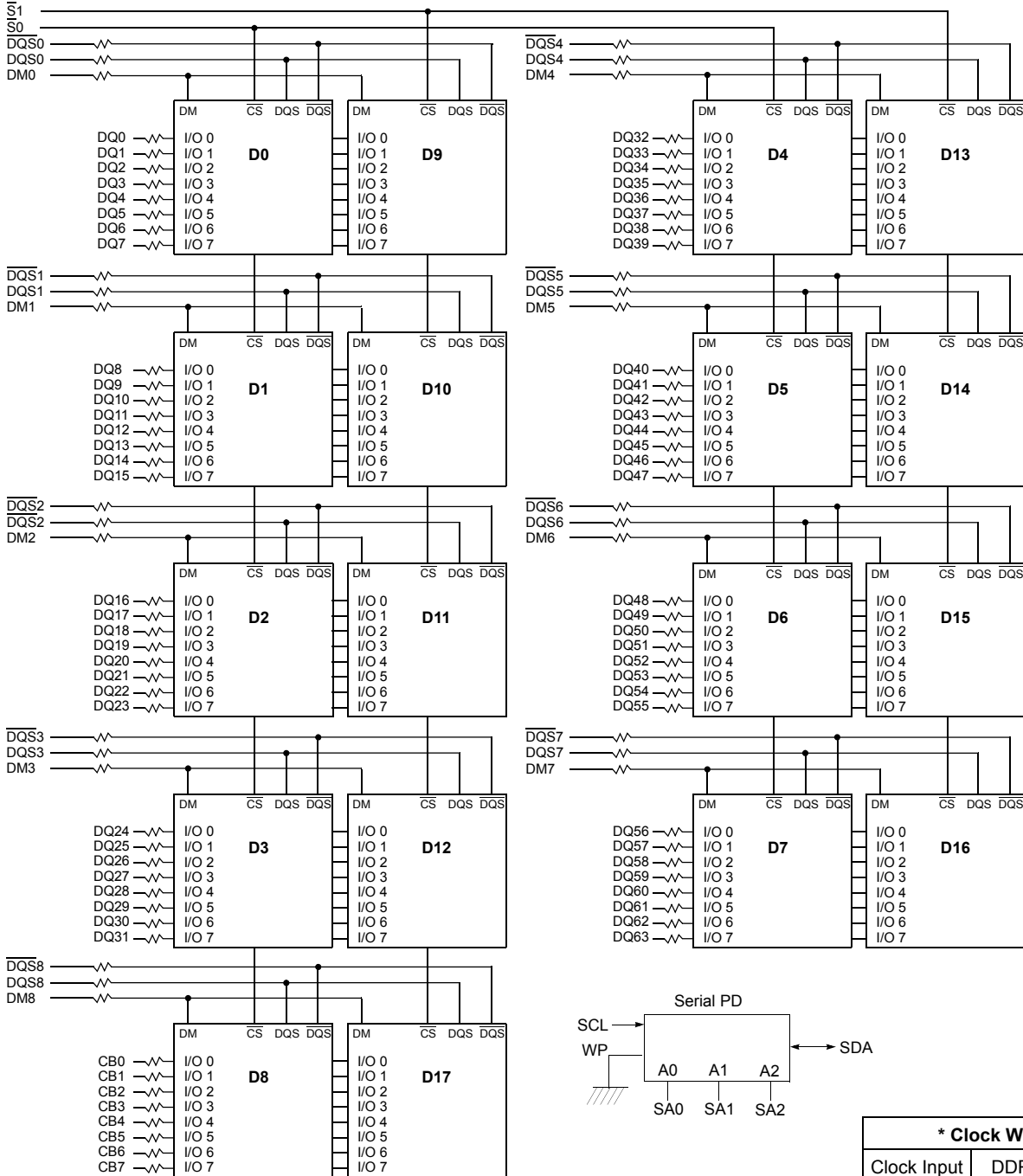

- BA0 - BA2 → BA0-BA2 : DDR2 SDRAMs D0 - D17
- A0 - A13 → A0-A13 : DDR2 SDRAMs D0 - D17
- CKE0 → CKE : DDR2 SDRAMs D0 - D8
- CKE1 → CKE : DDR2 SDRAMs D9 - D17
- RAS → RAS : DDR2 SDRAMs D0 - D17
- CAS → CAS : DDR2 SDRAMs D0 - D17
- WE → WE : DDR2 SDRAMs D0 - D17
- ODT0 → ODT : DDR2 SDRAMs D0 - D8
- ODT1 → ODT : DDR2 SDRAMs D9 - D17

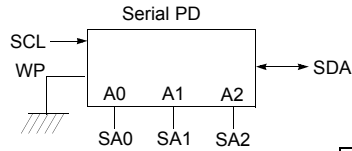
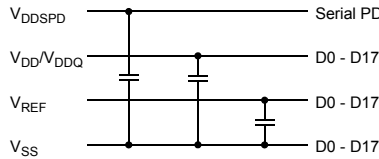

* Clock Wiring	
Clock Input	DDR2 SDRAMs
*CK0/CK0	6 DDR2 SDRAMs
*CK1/CK1	6 DDR2 SDRAMs
*CK2/CK2	6 DDR2 SDRAMs

*Wire per Clock Loading Table/Wiring Diagrams

- NOTE :**
- DQ, DM, DQS/DQS resistors : 22 Ohms ± 5%.
 - B_{Ax}, A_x, RAS, CAS, WE resistors : 7.5 Ohms ± 5%.

9. Absolute Maximum DC Ratings

Symbol	Parameter	Rating	Units	NOTE
V_{DD}	Voltage on V_{DD} pin relative to V_{SS}	- 1.0 V ~ 2.3 V	V	1
V_{DDQ}	Voltage on V_{DDQ} pin relative to V_{SS}	- 0.5 V ~ 2.3 V	V	1
V_{DDL}	Voltage on V_{DDL} pin relative to V_{SS}	- 0.5 V ~ 2.3 V	V	1
V_{IN}, V_{OUT}	Voltage on any pin relative to V_{SS}	- 0.5 V ~ 2.3 V	V	1
T_{STG}	Storage Temperature	-55 to +100	°C	1, 2

NOTE :

- Stresses greater than those listed under "Absolute Maximum Ratings" may cause permanent damage to the device. This is a stress rating only and functional operation of the device at these or any other conditions above those indicated in the operational sections of this specification is not implied. Exposure to absolute maximum rating conditions for extended periods may affect reliability.
- Storage Temperature is the case surface temperature on the center/top side of the DRAM. For the measurement conditions, please refer to JESD51-2 standard.

10. AC & DC Operating Conditions

10.1 Recommended DC Operating Conditions (SSTL - 1.8)

Symbol	Parameter	Rating			Units	NOTE
		Min.	Typ.	Max.		
V_{DD}	Supply Voltage	1.7	1.8	1.9	V	
V_{DDL}	Supply Voltage for DLL	1.7	1.8	1.9	V	4
V_{DDQ}	Supply Voltage for Output	1.7	1.8	1.9	V	4
V_{REF}	Input Reference Voltage	$0.49 \cdot V_{DDQ}$	$0.50 \cdot V_{DDQ}$	$0.51 \cdot V_{DDQ}$	mV	1,2
V_{TT}	Termination Voltage	$V_{REF} - 0.04$	V_{REF}	$V_{REF} + 0.04$	V	3

NOTE : There is no specific device V_{DD} supply voltage requirement for SSTL-1.8 compliance. However under all conditions V_{DDQ} must be less than or equal to V_{DD} .

- The value of V_{REF} may be selected by the user to provide optimum noise margin in the system. Typically the value of V_{REF} is expected to be about $0.5 \times V_{DDQ}$ of the transmitting device and V_{REF} is expected to track variations in V_{DDQ} .
- Peak to peak AC noise on V_{REF} may not exceed $\pm 2\% V_{REF}(DC)$.
- V_{TT} of transmitting device must track V_{REF} of receiving device.
- AC parameters are measured with V_{DD} , V_{DDQ} and V_{DDL} tied together.
- SODIMMs that include an optional temperature sensor may require a restricted V_{DDSPD} operating voltage range for proper operation of the temperature sensor. Refer to the thermal sensor specification for details regarding the supported voltage range. All other functions of the SODIMM SPD are supported across the full V_{DDSPD} range.

10.2 Operating Temperature Condition

Symbol	Parameter	Rating	Units	NOTE
T _{OPER}	Operating Temperature	0 to 95	°C	1, 2

NOTE :
 1. Operating Temperature is the case surface temperature on the center/top side of the DRAM. For the measurement conditions, please refer to JESD51.2 standard.
 2. At 85 - 95 °C operation temperature range, doubling refresh commands in frequency to a 32ms period (tREFI=3.9 us) is required, and to enter to self refresh mode at this temperature range, an EMRS command is required to change internal refresh rate.

10.3 Input DC Logic Level

Symbol	Parameter	Min.	Max.	Units	NOTE
V _{IH(DC)}	DC input logic high	V _{REF} + 0.125	V _{DDQ} + 0.3	V	
V _{IL(DC)}	DC input logic low	- 0.3	V _{REF} - 0.125	V	

10.4 Input AC Logic Level

Symbol	Parameter	DDR2-667, DDR2-800		Units
		Min.	Max.	
V _{IH(AC)}	AC input logic high	V _{REF} + 0.200		V
V _{IL(AC)}	AC input logic low		V _{REF} - 0.200	V

10.5 AC Input Test Conditions

Symbol	Condition	Value	Units	NOTE
V _{REF}	Input reference voltage	0.5 * V _{DDQ}	V	1
V _{SWING(MAX)}	Input signal maximum peak to peak swing	1.0	V	1
SLEW	Input signal minimum slew rate	1.0	V/ns	2, 3

NOTE :
 1. Input waveform timing is referenced to the input signal crossing through the V_{IH/IL(AC)} level applied to the device under test.
 2. The input signal minimum slew rate is to be maintained over the range from V_{REF} to V_{IH(AC)} min for rising edges and the range from V_{REF} to V_{IL(AC)} max for falling edges as shown in the below figure.
 3. AC timings are referenced with input waveforms switching from V_{IL(AC)} to V_{IH(AC)} on the positive transitions and V_{IH(AC)} to V_{IL(AC)} on the negative transitions.

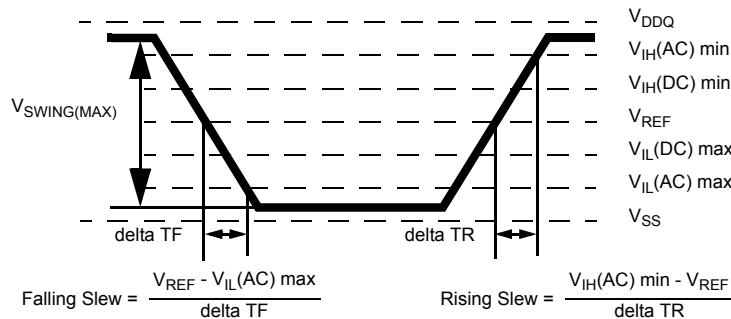

Figure 1. AC Input Test Signal Waveform

11. IDD Specification Parameters Definition

(IDD values are for full operating range of Voltage and Temperature)

Symbol	Proposed Conditions	Units	NOTE
IDD0	Operating one bank active-precharge current; tCK = tCK(IDD), tRC = tRC(IDD), tRAS = tRASmin(IDD); CKE is HIGH, \overline{CS} is HIGH between valid commands; Address bus inputs are SWITCHING; Data bus inputs are SWITCHING	mA	
IDD1	Operating one bank active-read-precharge current; IOUT = 0mA; BL = 4, CL = CL(IDD), AL = 0; tCK = tCK(IDD), tRC = tRC(IDD), tRAS = tRASmin(IDD), tRCD = tRCD(IDD); CKE is HIGH, \overline{CS} is HIGH between valid commands; Address bus inputs are SWITCHING; Data pattern is same as IDD4W	mA	
IDD2P	Precharge power-down current; All banks idle; tCK = tCK(IDD); CKE is LOW; Other control and address bus inputs are STABLE; Data bus inputs are FLOATING	mA	
IDD2Q	Precharge quiet standby current; All banks idle; tCK = tCK(IDD); CKE is HIGH, \overline{CS} is HIGH; Other control and address bus inputs are STABLE; Data bus inputs are FLOATING	mA	
IDD2N	Precharge standby current; All banks idle; tCK = tCK(IDD); CKE is HIGH, \overline{CS} is HIGH; Other control and address bus inputs are SWITCHING; Data bus inputs are SWITCHING	mA	
IDD3P	Active power-down current; All banks open; tCK = tCK(IDD); CKE is LOW; Other control and address bus inputs are STABLE; Data bus inputs are FLOATING	Fast PDN Exit MRS(12) = 0	mA
		Slow PDN Exit MRS(12) = 1	mA
IDD3N	Active standby current; All banks open; tCK = tCK(IDD), tRAS = tRASmax(IDD), tRP = tRP(IDD); CKE is HIGH, \overline{CS} is HIGH between valid commands; Other control and address bus inputs are SWITCHING; Data bus inputs are SWITCHING	mA	
IDD4W	Operating burst write current; All banks open, Continuous burst writes; BL = 4, CL = CL(IDD), AL = 0; tCK = tCK(IDD), tRAS = tRASmax(IDD), tRP = tRP(IDD); CKE is HIGH, \overline{CS} is HIGH between valid commands; Address bus inputs are SWITCHING; Data bus inputs are SWITCHING	mA	
IDD4R	Operating burst read current; All banks open, Continuous burst reads, IOUT = 0mA; BL = 4, CL = CL(IDD), AL = 0; tCK = tCK(IDD), tRAS = tRASmax(IDD), tRP = tRP(IDD); CKE is HIGH, \overline{CS} is HIGH between valid commands; Address bus inputs are SWITCHING; Data pattern is same as IDD4W	mA	
IDD5B	Burst auto refresh current; tCK = tCK(IDD); Refresh command at every tRFC(IDD) interval; CKE is HIGH, \overline{CS} is HIGH between valid commands; Other control and address bus inputs are SWITCHING; Data bus inputs are SWITCHING	mA	
IDD6	Self refresh current; CK and \overline{CK} at 0V; CKE ≤ 0.2V; Other control and address bus inputs are FLOATING; Data bus inputs are FLOATING	Normal	mA
		Low Power	mA
IDD7	Operating bank interleave read current; All bank interleaving reads, IOUT = 0mA; BL = 4, CL = CL(IDD), AL = tRCD(IDD)-1*tCK(IDD); tCK = tCK(IDD), tRC = tRC(IDD), tRRD = tRRD(IDD), tFAW = tFAW(IDD), tRCD = 1*tCK(IDD); CKE is HIGH, \overline{CS} is HIGH between valid commands; Address bus inputs are STABLE during DESELECTs; Data pattern is same as IDD4R; Refer to the following page for detailed timing conditions	mA	

12. Operating Current Table :

12.1 M378T2863FBS : 1GB(128Mx8 *8) Module

(TA=0°C, V_{DD}= 1.9V)

Symbol	800@CL=5	800@CL6	667@CL=5	Units	NOTE
	CE7	CF7	CE6		
IDD0	360	360	344	mA	
IDD1	408	408	384	mA	
IDD2P	80	80	80	mA	
IDD2Q	160	160	160	mA	
IDD2N	200	200	192	mA	
IDD3P-F	184	184	176	mA	
IDD3P-S	160	160	160	mA	
IDD3N	296	296	280	mA	
IDD4W	576	576	520	mA	
IDD4R	640	640	560	mA	
IDD5	840	840	800	mA	
IDD6	80	80	80	mA	
IDD7	1,280	1,280	1,160	mA	

NOTE : Module IDD was calculated on the basis of component IDD and can be differently measured according to DQ loading cap.

12.2 M378T5663FB3 : 2GB(128Mx8 *16) Module

(TA=0°C, V_{DD}= 1.9V)

Symbol	800@CL=5	800@CL=6	667@CL=5	Units	NOTE
	CE7	CF7	CE6		
IDD0	560	560	536	mA	
IDD1	608	608	576	mA	
IDD2P	160	160	160	mA	
IDD2Q	320	320	320	mA	
IDD2N	400	400	384	mA	
IDD3P-F	368	368	352	mA	
IDD3P-S	320	320	320	mA	
IDD3N	496	496	472	mA	
IDD4W	776	776	712	mA	
IDD4R	840	840	752	mA	
IDD5	1,040	1,040	992	mA	
IDD6	160	160	160	mA	
IDD7	1,480	1,480	1,352	mA	

NOTE : Module IDD was calculated on the basis of component IDD and can be differently measured according to DQ loading cap.

12.3 M391T2863FB3 : 1GB(128Mx8 *9) ECC Module

(TA=0°C, V_{DD}= 1.9V)

Symbol	800@CL=5	800@CL=6	667@CL=5	Units	NOTE
	CE7	CF7	CE6		
IDD0	405	405	387	mA	
IDD1	459	459	432	mA	
IDD2P	90	90	90	mA	
IDD2Q	180	180	180	mA	
IDD2N	225	225	216	mA	
IDD3P-F	207	207	198	mA	
IDD3P-S	180	180	180	mA	
IDD3N	333	333	315	mA	
IDD4W	648	648	585	mA	
IDD4R	720	720	630	mA	
IDD5	945	945	900	mA	
IDD6	90	90	90	mA	
IDD7	1,440	1,440	1,305	mA	

NTOE : Module IDD was calculated on the basis of component IDD and can be differently measured according to DQ loading cap.

12.4 M391T5663FB3 : 2GB(128Mx8 *18) ECC Module

(TA=0°C, V_{DD}= 1.9V)

Symbol	800@CL=5	800@CL=6	667@CL=5	Units	NOTE
	CE7	CF7	CE6		
IDD0	630	630	603	mA	
IDD1	684	684	648	mA	
IDD2P	180	180	180	mA	
IDD2Q	360	360	360	mA	
IDD2N	450	450	432	mA	
IDD3P-F	414	414	396	mA	
IDD3P-S	360	360	360	mA	
IDD3N	558	558	531	mA	
IDD4W	873	873	801	mA	
IDD4R	945	945	846	mA	
IDD5	1,170	1,170	1,116	mA	
IDD6	180	180	180	mA	
IDD7	1,665	1,665	1,521	mA	

NTOE : Module IDD was calculated on the basis of component IDD and can be differently measured according to DQ loading cap.

13. Input/Output Capacitance

(V_{DD}=1.8V, V_{DDQ}=1.8V, TA=25°C)

Parameter	Symbol	Min	Max	Min	Max	Units
Non-ECC		M378T2863FB3		M378T5663FB3		
Input capacitance, CK and \overline{CK}	CCK0	-	24	-	26	pF
	CCK1	-	25	-	28	
	CCK2	-	25	-	28	
Input capacitance, CKE and \overline{CS}	Cl1	-	42	-	42	
Input capacitance, Addr, \overline{RAS} , \overline{CAS} , \overline{WE}	Cl2	-	42	-	42	
Input/output capacitance, DQ, DM, DQS, \overline{DQS}	CIO	-	6	-	10	
ECC		M391T2863FB3		M391T5663FB3		Units
Input capacitance, CK and \overline{CK}	CCK0	-	25	-	28	pF
	CCK1	-	25	-	28	
	CCK2	-	25	-	28	
Input capacitance, CKE and \overline{CS}	Cl ₁	-	44	-	44	
Input capacitance, Addr, \overline{RAS} , \overline{CAS} , \overline{WE}	Cl ₂	-	44	-	44	
Input/output capacitance, DQ, DM, DQS, \overline{DQS}	CIO	-	6	-	10	

NOTE : DM is internally loaded to match DQ and DQS identically.

14. Electrical Characteristics & AC Timing for DDR2-800/667

(0°C ≤ T_{OPER} ≤ 95°C, V_{DDQ} = 1.8V ± 0.1V, V_{DD} = 1.8V ± 0.1V)

14.1 Refresh Parameters by Device Density

Parameter	Symbol	256Mb	512Mb	1Gb	2Gb	4Gb	Units
Refresh to active/Refresh command time	tRFC	75	105	127.5	195	327.5	ns
Average periodic refresh interval	tREFI	0°C ≤ T _{CASE} ≤ 85°C	7.8	7.8	7.8	7.8	μs
		85°C < T _{CASE} ≤ 95°C	3.9	3.9	3.9	3.9	μs

14.2 Speed Bins and CL, tRCD, tRP, tRC and tRAS for Corresponding Bin

Speed	DDR2-800(E7)		DDR2-800(F7)		DDR2-667(E6)		Units
Bin(CL - tRCD - tRP)	5 - 5 - 5		6 - 6 - 6		5 - 5 - 5		
Parameter	min	max	min	max	min	max	
tCK, CL=3	5	8	-	-	5	8	ns
tCK, CL=4	3.75	8	3.75	8	3.75	8	ns
tCK, CL=5	2.5	8	3	8	3	8	ns
tCK, CL=6	-	-	2.5	8	-	-	ns
tRCD	12.5	-	15	-	15	-	ns
tRP	12.5	-	15	-	15	-	ns
tRC	57.5	-	60	-	60	-	ns
tRAS	45	70000	45	70000	45	70000	ns



14.3 Timing Parameters by Speed Grade

(Refer to notes for informations related to this table at the component datasheet)

Parameter	Symbol	DDR2-800		DDR2-667		Units	NOTE
		min	max	min	max		
DQ output access time from CK/\overline{CK}	tAC	-400	400	- 450	450	ps	40
DQS output access time from CK/\overline{CK}	tDQSCK	-350	350	- 400	400	ps	40
Average clock HIGH pulse width	tCH(avg)	0.48	0.52	0.48	0.52	tCK(avg)	35,36
Average clock LOW pulse width	tCL(avg)	0.48	0.52	0.48	0.52	tCK(avg)	35,36
CK half pulse period	tHP	Min(tCL(abs), tCH(abs))	x	Min(tCL(abs), tCH(abs))	x	ps	37
Average clock period	tCK(avg)	2500	8000	3000	8000	ps	35,36
DQ and DM input hold time	tDH(base)	125	x	175	x	ps	6,7,8,21,28,31
DQ and DM input setup time	tDS(base)	50	x	100	x	ps	6,7,8,20,28,31
Control & Address input pulse width for each input	tIPW	0.6	x	0.6	x	tCK(avg)	
DQ and DM input pulse width for each input	tDIPW	0.35	x	0.35	x	tCK(avg)	
Data-out high-impedance time from CK/\overline{CK}	tHZ	x	tAC(max)	x	tAC(max)	ps	18,40
DQS/ \overline{DQS} low-impedance time from CK/\overline{CK}	tLZ(DQS)	tAC(min)	tAC(max)	tAC(min)	tAC(max)	ps	18,40
DQ low-impedance time from CK/\overline{CK}	tLZ(DQ)	2* tAC(min)	tAC(max)	2* tAC(min)	tAC(max)	ps	18,40
DQS-DQ skew for DQS and associated DQ signals	tDQSQ	x	200	x	240	ps	13
DQ hold skew factor	tQHS	x	300	x	340	ps	38
DQ/DQS output hold time from DQS	tQH	tHP - tQHS	x	tHP - tQHS	x	ps	39
DQS latching rising transitions to associated clock edges	tDQSS	- 0.25	0.25	-0.25	0.25	tCK(avg)	30
DQS input HIGH pulse width	tDQSH	0.35	x	0.35	x	tCK(avg)	
DQS input LOW pulse width	tDQSL	0.35	x	0.35	x	tCK(avg)	
DQS falling edge to CK setup time	tDSS	0.2	x	0.2	x	tCK(avg)	30
DQS falling edge hold time from CK	tDSH	0.2	x	0.2	x	tCK(avg)	30
Mode register set command cycle time	tMRD	2	x	2	x	nCK	
MRS command to ODT update delay	tMOD	0	12	0	12	ns	32
Write postamble	tWPST	0.4	0.6	0.4	0.6	tCK(avg)	10
Write preamble	tWPRE	0.35	x	0.35	x	tCK(avg)	
Address and control input hold time	tIH(base)	250	x	275	x	ps	5,7,9,23,29
Address and control input setup time	tIS(base)	175	x	200	x	ps	5,7,9,22,29
Read preamble	tRPRE	0.9	1.1	0.9	1.1	tCK(avg)	19,41
Read postamble	tRPST	0.4	0.6	0.4	0.6	tCK(avg)	19,42
Activate to activate command period for 1KB page size products	tRRD	7.5	x	7.5	x	ns	4,32
Activate to activate command period for 2KB page size products	tRRD	10	x	10	x	ns	4,32

Parameter	Symbol	DDR2-800		DDR2-667		Units	NOTE
		min	max	min	max		
Four Activate Window for 1KB page size products	tFAW	35	x	37.5	x	ns	32
Four Activate Window for 2KB page size products	tFAW	45	x	50	x	ns	32
CAS to $\overline{\text{CAS}}$ command delay	tCCD	2	x	2	x	nCK	
Write recovery time	tWR	15	x	15	x	ns	32
Auto precharge write recovery + precharge time	tDAL	WR + tnRP	x	WR + tnRP	x	nCK	33
Internal write to read command delay	tWTR	7.5	x	7.5	x	ns	24,32
Internal read to precharge command delay	tRTP	7.5	x	7.5	x	ns	3,32
Exit self refresh to a non-read command	tXSNR	tRFC + 10	x	tRFC + 10	x	ns	32
Exit self refresh to a read command	tXSRD	200	x	200	x	nCK	
Exit precharge power down to any command	tXP	2	x	2	x	nCK	
Exit active power down to read command	tXARD	2	x	2	x	nCK	1
Exit active power down to read command (slow exit, lower power)	tXARDS	8 - AL	x	7 - AL	x	nCK	1,2
CKE minimum pulse width (HIGH and LOW pulse width)	tCKE	3	x	3	x	nCK	27
ODT turn-on delay	tAOND	2	2	2	2	nCK	16
ODT turn-on	tAON	tAC(min)	tAC(max)+0.7	tAC(min)	tAC(max)+0.7	ns	6,16,40
ODT turn-on (Power-Down mode)	tAONPD	tAC(min)+2	2*tCK(avg)+tAC(max)+1	tAC(min)+2	2*tCK(avg)+tAC(max)+1	ns	
ODT turn-off delay	tAOFD	2.5	2.5	2.5	2.5	nCK	17,45
ODT turn-off	tAOF	tAC(min)	tAC(max)+0.6	tAC(min)	tAC(max)+0.6	ns	17,43,45
ODT turn-off (Power-Down mode)	tAOFPD	tAC(min)+2	2.5*tCK(avg)+tAC(max)+1	tAC(min)+2	2.5*tCK(avg)+tAC(max)+1	ns	
ODT to power down entry latency	tANPD	3	x	3	x	nCK	
ODT power down exit latency	tAXPD	8	x	8	x	nCK	
OCD drive mode output delay	tOIT	0	12	0	12	ns	32
Minimum time clocks remains ON after CKE asynchronously drops LOW	tDelay	tIS+tCK(avg)+tIH	x	tIS+tCK(avg)+tIH	x	ns	15

15. Physical Dimensions :

15.1 128Mbx8 based 128Mx64 Module (1 Rank)

- M378T2863FBS/M391T2863FB3

Units : Millimeters

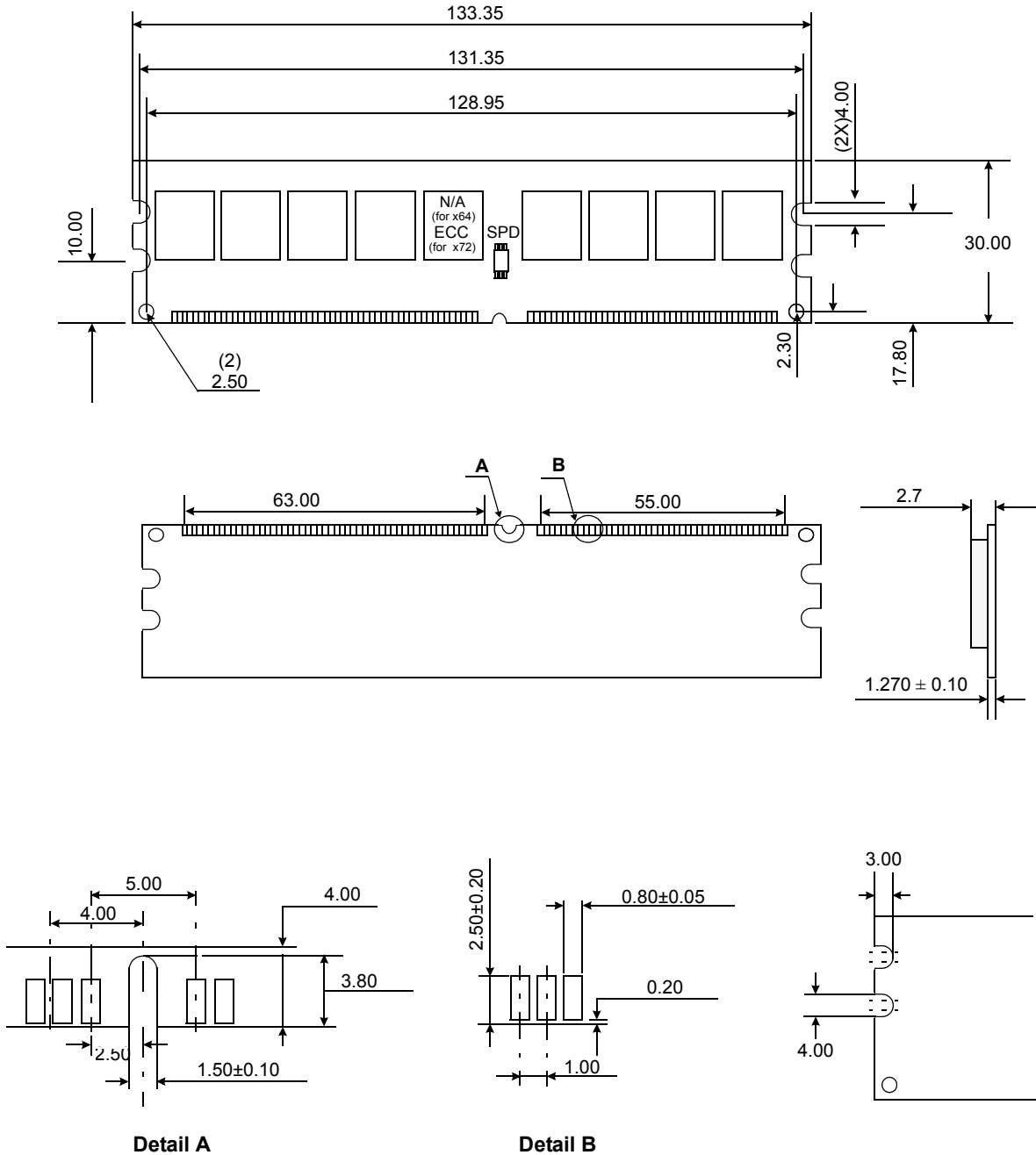

The used device is 128M x8 DDR2 SDRAM, Flip-chip.
 DDR2 SDRAM Part NO : K4T1G084QF

15.2 128Mbx8 based 128Mx72 Module (1 Rank)

- M378T5663FB3/M391T5663FB3

Units : Millimeters

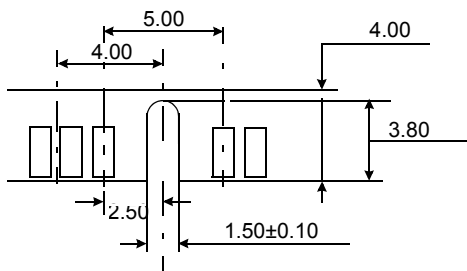
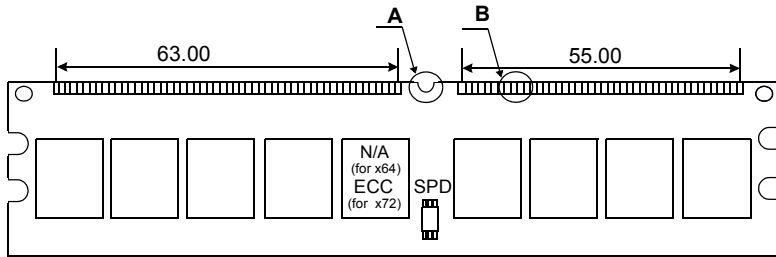
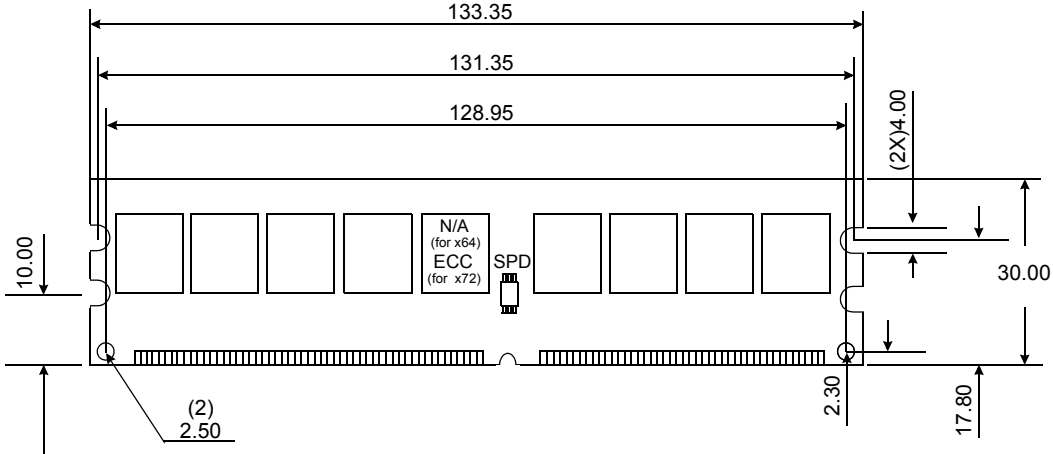

Detail A

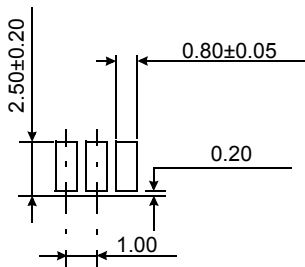

Detail B

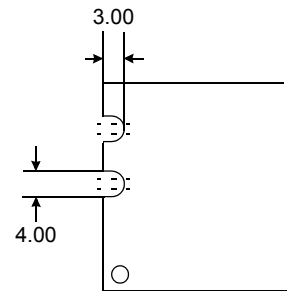

The used device is 128M x8 DDR2 SDRAM, Flip-Chip.
DDR2 SDRAM Part NO : K4T1G084QF