

# M51390ASP

## PAL/NTSC VIDEO CHROMA DEFLECTION

### DESCRIPTION

The M51390ASP is a semiconductor integrated circuit for video, chroma, and deflection. Combined with IC M51346AP for VIF/SIF, it realizes practical color television using only two IC components.

Circuit configuration includes built-in sync separation, horizontal AFC, horizontal oscillator, horizontal count-down, vertical count-down, contrast control, luminance control, picture quality control, ACC/killer detector, ident detector, APC detector, chroma oscillator, NTSC tint control, and chroma demodulator functions.

The M51390ASP is packaged as a 32-pin, bipolar monolithic, formed plastic shrunk DIP.

### FEATURES

- Large-scale, single-chip construction enhances practicality and reliability of the television set itself while contributing to lower power consumption.
- Places of adjustment and number of external components are minimized.
- NTSC system switch enables construction of a PAL/NTSC system with a minimal amount of peripheral components. (Switches demodulator axis, demodulation ratio, PAL matrix, and tint control.)
- Employs a sync detector system for ACC/killer detector; realizes superior weak electric field killer level.
- Double AFC in the horizontal circuit effectively reduces weak electric field horizontal "jitter," and "bending" on the screen is minimized thanks to luminance alteration. VCR switch improves skew distortion. Sync sensor circuit

### PIN CONFIGURATION (TOP VIEW)

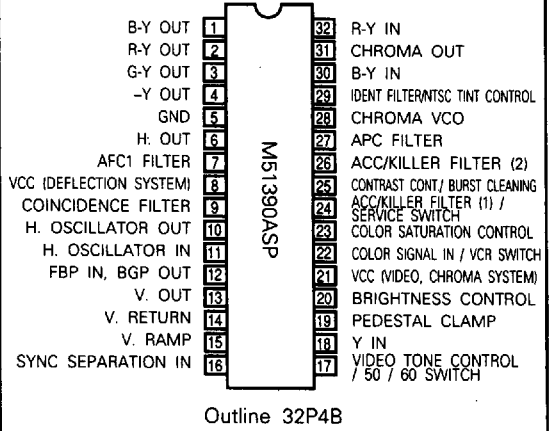

- not only expands pull-in range, but can be used as a sensor signal for sound muting, automatic channel selection, etc.
- Contains built-in service switch. (Contrast minimum killer on, vertical output off)

### APPLICATION

PAL/NTSC System Color Television Receiver

### RECOMMENDED OPERATING CONDITION

Supply voltage range ..... 10~12.5V  
 Rated supply voltage ..... 12.0V

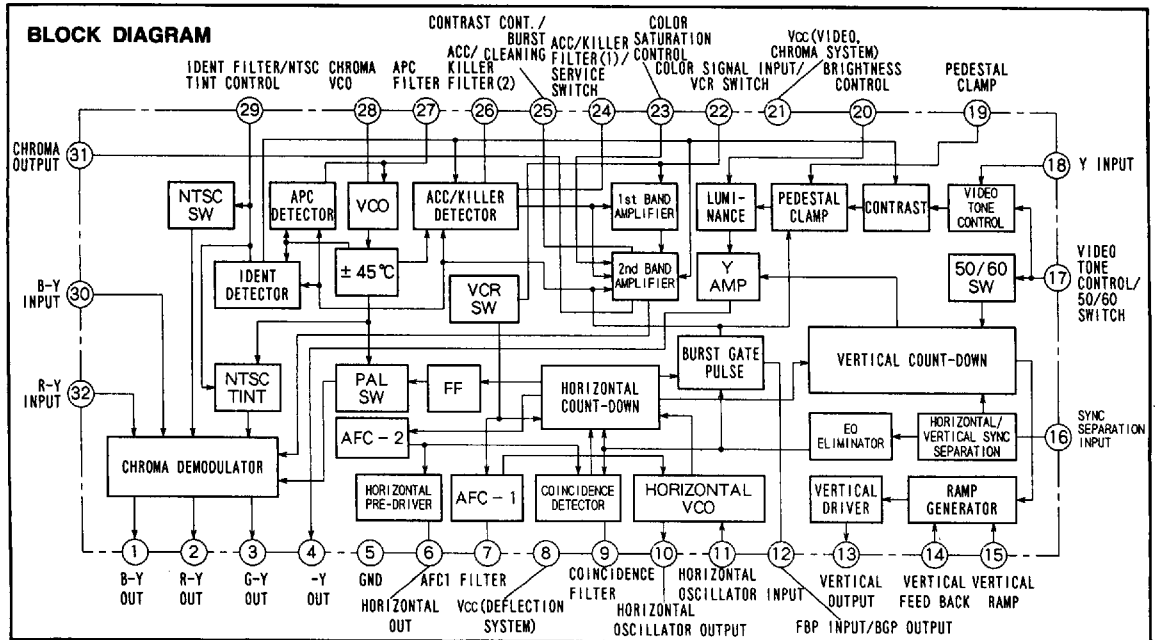

6249826 0021074 485



## M51390ASP

## PAL/NTSC VIDEO CHROMA DEFLECTION

## ABSOLUTE MAXIMUM RATINGS

Symbol	Parameter	Ratings	Unit
V <sub>cc</sub>	Supply voltage	13	V
P <sub>d</sub>	Power dissipation	1.25	W
Surge	Surge voltage resistance	± 200	V
V <sub>14</sub>	Pin ⑭ voltage	0.28V <sub>cc</sub> + 6	V
I <sub>15</sub>	Pin ⑮ output current	+ 6	mA
I <sub>12</sub>	Pin ⑫ input current	- 1.0	mA
T <sub>opr</sub>	Operating temperature	- 20~65	°C
T <sub>stg</sub>	Storage temperature	- 40~125	°C

## VIDEO/CHROMA INPUT IMPEDANCE

Symbol	Parameter	Test point	Test conditions	Limits			Unit
				Min.	Typ.	Max.	
R <sub>i</sub> (18)	Video input resistance	18	V <sub>cc</sub> = 12V, Test with LCR meter, 4.43MHz, 0.1V		5		k Ω
C <sub>i</sub> (18)	Video input capacitance	18			5.5		pF
R <sub>i</sub> (17)	Picture quality input resistance	17			9.7		k Ω
C <sub>i</sub> (17)	Picture quality input capacitance	17			6		pF
R <sub>i</sub> (22)	Chroma input resistance	22			2		k Ω
C <sub>i</sub> (22)	Chroma input capacitance	22			20		pF
R <sub>i</sub> (30)	B - Y input resistance	30			3		k Ω
C <sub>i</sub> (30)	B - Y input capacitance	30			7		pF
R <sub>i</sub> (32)	R - Y input resistance	32			3		k Ω
C <sub>i</sub> (32)	R - Y input capacitance	32			7		pF

## MAXIMUM OUTPUT CURRENT

Symbol	Pin number	Recommended value	Maximum value	Unit
I <sub>1</sub>	①	2.0	4.0	mA
I <sub>2</sub>	②	2.0	4.0	mA
I <sub>3</sub>	③	2.0	4.0	mA
I <sub>4</sub>	④	2.0	4.0	mA
I <sub>6</sub>	⑥	3.0	6.0	mA
I <sub>10</sub>	⑩	1.0	3.0	mA
I <sub>13</sub>	⑬	1.5	3.0	mA
I <sub>31</sub>	⑳	5.0	10.0	mA

M51390ASP

PAL/NTSC VIDEO CHROMA DEFLECTION

ELECTRICAL CHARACTERISTICS (Ta = 25°C, unless otherwise noted)

VIDEO SECTION

Symbol	Parameter	Test point	Input C	Test conditions *												Limits			Unit	
				17A	19	20A	23A	25A	29A	S24-1	S24-2	S26	S29	S32	12A	Note	Min.	Typ.		Max.
I <sub>CC</sub> - YC	Circuit current	A1	-	-	-	-	-	-	-	ON	OFF	OFF	OFF	1	V <sub>CC</sub>	Note1	35	49	63	mA
Y <sub>max</sub>	Maximum output	4	SG1	-	-	-	-	V <sub>CC</sub>	-	ON	OFF	OFF	OFF	1	V <sub>CC</sub>	Note1	7.5	8.6		V <sub>P-P</sub>
GY	Video amplifier gain	4	SG2	-	2V	-	-	V <sub>CC</sub>	-	ON	OFF	OFF	OFF	1	V <sub>CC</sub>	Note2	18	21	24	dB
GY <sub>mid</sub>	Contrast control characteristics-1	4	SG2	-	2V	-	-	6V	-	ON	OFF	OFF	OFF	1	V <sub>CC</sub>	Note3	0.7	1.0	1.4	V <sub>P-P</sub>
GY <sub>min</sub>	Contrast control characteristics-2	4	SG2	-	2V	-	-	0V	-	ON	OFF	OFF	OFF	1	V <sub>CC</sub>	Note4		-40	-30	dB
GY <sub>max</sub>	Contrast control characteristics-3	4	SG2	-	2V	-	-	V <sub>CC</sub>	-	ON	OFF	OFF	OFF	1	V <sub>CC</sub>	Note5	4.0	7.0	10.0	dB
YT <sub>mid</sub>	Video tone control characteristics-1	4	SG3	-	2V	-	-	6V	-	ON	OFF	OFF	OFF	1	V <sub>CC</sub>	Note6	0.9	1.3	1.8	V <sub>P-P</sub>
YT <sub>min</sub>	Video tone control characteristics-2	4	SG3	V <sub>CC</sub>	2V	-	-	6V	-	ON	OFF	OFF	OFF	1	V <sub>CC</sub>	Note7	-11	-8	-5	dB
YT <sub>max</sub>	Video tone control characteristics-3	4	SG3	1.5V	2V	-	-	6V	-	ON	OFF	OFF	OFF	1	V <sub>CC</sub>	Note8	2	5	8	dB
YP	Peaking value	4	C SG2 SG3	-	2V	-	-	6V	-	ON	OFF	OFF	OFF	1	V <sub>CC</sub>	Note9	0.5	3.5	6.5	dB
YBRT <sub>mid</sub>	Brightness control characteristics-1	4	-	-	-	6V	-	6V	-	ON	OFF	OFF	OFF	1	V <sub>CC</sub>	Note10	3.9	4.5	5.1	V
YBRT <sub>min</sub>	Brightness control characteristics-2	4	-	-	-	V <sub>CC</sub>	-	6V	-	ON	OFF	OFF	OFF	1	V <sub>CC</sub>	Note11	8.6	9.2	9.8	V
YBRT <sub>max</sub>	Brightness control characteristics-3	4	-	-	-	0V	-	6V	-	ON	OFF	OFF	OFF	1	V <sub>CC</sub>	Note12		0.8	1.4	V
Y <sub>f</sub>	Frequency characteristics	4	C SG2 SG4	-	2V	-	-	6V	-	ON	OFF	OFF	OFF	1	V <sub>CC</sub>	Note13	-2	2	6	dB
DG	Differential gain	4	C SG2	-	2.0V 2.7V	-	-	6V	-	ON	OFF	OFF	OFF	1	V <sub>CC</sub>	Note14			10	%
H.BLKTH	Horizontal blanking threshold voltage	4 1A	D SG5	-	2V	-	-	6V	-	ON	OFF	OFF	OFF	1	V <sub>CC</sub>	Note15	9.75	10.25	10.75	V
YV.BLK	Vertical blanking voltage	4	-	-	-	-	-	6V	-	ON	OFF	OFF	OFF	1	V <sub>CC</sub>	Note16	9.3	9.9	10.5	V

\*: "-" indicates OPEN.

M51390ASP

PAL/NTSC VIDEO CHROMA DEFLECTION

CHROMA SECTION

Symbol	Parameter	Test point	Input D	Test conditions *												Limits			Unit	
				17A	19	20A	23A	25A	29A	S24-1	S24-2	S26	S29	S32	12A	Note	Min.	Typ.		Max.
C <sub>max</sub>	Maximum output	31	SG5 0dB	-	-	-	V <sub>cc</sub>	V <sub>cc</sub>	-	ON	OFF	OFF	OFF	1	V <sub>cc</sub>	Note17	2.0	2.6	3.2	V <sub>P-P</sub>
GC	Chroma maximum gain	31	SG5 -22dB	-	-	-	V <sub>cc</sub>	V <sub>cc</sub>	-	ON	OFF	OFF	OFF	1	V <sub>cc</sub>	Note17	41	46	51	dB
Acc1	ACC characteristics - 1	31	SG5 0dB -22dB	-	-	-	6V	-	ON	OFF	OFF	OFF	1	V <sub>cc</sub>	Note18	-8	-2.5	0	dB	
Acc2	ACC characteristics - 2	31	SG5 +6dB	-	-	-	6V	-	ON	OFF	OFF	OFF	1	V <sub>cc</sub>	Note19	-2	0.4	3	dB	
KIL	Killer operation input	SG5 23	SG5	-	-	-	6V	-	ON	OFF	OFF	OFF	1	V <sub>cc</sub>	Note20	-34	-28	-22	dB	
D.KIL	Killer color residual	31	SG5 0dB	-	-	-	6V	-	ON	OFF	OFF	OFF	1	V <sub>cc</sub>	Note21			200	mV <sub>P-P</sub>	
CC <sub>mid</sub>	Color control characteristics - 1	31	SG5 0dB	-	-	-	V <sub>cc</sub>	-	ON	OFF	OFF	OFF	1	V <sub>cc</sub>	Note22	0.65	0.95	1.35	V <sub>P-P</sub>	
CC <sub>min</sub>	Color control characteristics - 2	31	SG5 0dB	-	-	0V	V <sub>cc</sub>	-	ON	OFF	OFF	OFF	1	V <sub>cc</sub>	Note23		-40	-36	dB	
CC <sub>max</sub>	Color control characteristics - 3	31	SG5 0dB	-	-	V <sub>cc</sub>	V <sub>cc</sub>	-	ON	OFF	OFF	OFF	1	V <sub>cc</sub>	Note24	5	9	13	dB	
UC <sub>mid</sub>	Color tracking characteristics - 1	31	D SG5 0dB	-	-	V <sub>cc</sub>	6V	-	ON	OFF	OFF	OFF	1	V <sub>cc</sub>	Note25	1.45	2.1	2.75	V <sub>P-P</sub>	
UC <sub>min</sub>	Color tracking characteristics - 2	31	D SG5 0dB	-	-	V <sub>cc</sub>	0V	-	ON	OFF	OFF	OFF	1	V <sub>cc</sub>	Note26		-40	-36	dB	
UC <sub>max</sub>	Color tracking characteristics - 3	31	D SG5 0dB	-	-	V <sub>cc</sub>	V <sub>cc</sub>	-	ON	OFF	OFF	OFF	1	V <sub>cc</sub>	Note27	-1.5	1.5	4.5	dB	
APC1	APC pull - in range - 1	23 SG6	D SG6	-	-	-	6V	-	ON	OFF	OFF	OFF	1	V <sub>cc</sub>	Note28	500	900		Hz	
APC2	APC pull - in range - 2	23 SG6	D SG6	-	-	-	6V	-	ON	OFF	OFF	OFF	1	V <sub>cc</sub>	Note29	870	1500		Hz	
D <sub>cc</sub>	Demodulated output DC voltage	1A 2A 3A	-	-	-	-	6V	-	ON	OFF	OFF	OFF	1	V <sub>cc</sub>	Note30	6.5	7.0	7.5	V	
D <sub>offset</sub>	Demodulated DC offset	-	-	-	-	-	6V	-	-	-	-	-	-	Note31			0.3	V		
D <sub>max</sub>		1A	E SG7 0.5 V <sub>P-P</sub>	-	-	-	6V	-	OFF	OFF	OFF	OFF	2	V <sub>cc</sub>		3.7	4.7	5.7	V <sub>P-P</sub>	
D <sub>B-Y</sub>	B-Y demodulation sensitivity	1A	E SG5 0.2 V <sub>P-P</sub>	-	-	-	6V	-	OFF	OFF	OFF	OFF	2	V <sub>cc</sub>		2.25	2.75	3.25	V <sub>P-P</sub>	
R/B	Demodulation ratio - 1	2A	E SG7 0.2 V <sub>P-P</sub>	-	-	-	6V	-	OFF	OFF	OFF	OFF	2	V <sub>cc</sub>	Note32	0.59	0.66	0.73	-	
G/B	Demodulation ratio - 2	3A	E SG7 0.2 V <sub>P-P</sub>	-	-	-	6V	-	OFF	OFF	OFF	OFF	2	V <sub>cc</sub>	Note33	0.31	0.36	0.41	-	
ΔD/H	Demodulated output 1H level difference	2A	E SG7 0.2 V <sub>P-P</sub>	-	-	0V	6V	-	OFF	OFF	OFF	OFF	2	V <sub>cc</sub>	Note34			35	mV <sub>P-P</sub>	
C <sub>leak</sub>	Demodulated output carrier leak	1A 2A 3A	-	-	-	-	6V	-	OFF	OFF	OFF	OFF	1	V <sub>cc</sub>	Note35			0.2	V <sub>P-P</sub>	
V <sub>23</sub>	Pin ⊕ voltage(killer on)	23	-	-	-	-	6V	-	ON	OFF	ON	OFF	1	V <sub>cc</sub>			0.13	1.00	V	
V <sub>NTSC</sub>	NTSC operation control voltage	1A 29A	E SG7 0.2 V <sub>P-P</sub>	-	-	-	6V	Variable	OFF	OFF	OFF	ON	2	V <sub>cc</sub>	Note36	4.8	5.15	5.5	V	
NTSC B	Demodulated output (NTSC)	1A	D SG9 0dB	-	-	-	V <sub>cc</sub>	2V	ON	OFF	OFF	ON	1	V <sub>cc</sub>		2.25	3.25	4.55	V <sub>P-P</sub>	
NTSC R/B	Demodulation ratio (NTSC) - 1	2A	D SG9 0dB	-	-	-	V <sub>cc</sub>	2V	ON	OFF	OFF	ON	1	V <sub>cc</sub>	Note37	0.9	1.0	1.1	-	
NTSC G/B	Demodulation ratio (NTSC) - 2	3A	D SG9 0dB	-	-	-	V <sub>cc</sub>	2V	ON	OFF	OFF	ON	1	V <sub>cc</sub>	Note38	0.26	0.31	0.36	-	

\* : "-" indicates OPEN.

M51390ASP

PAL/NTSC VIDEO CHROMA DEFLECTION

CHROMA SECTION (cont.)

Symbol	Parameter	Test point	Input D	Test conditions *													Limits			Unit
				17A	19	20A	23A	25A	29A	S24-1	S24-2	S26	S29 ON/OFF	S32	12A	Note	Min.	Typ.	Max.	
V <sub>P/N</sub>	PAL/NTSC demodulated output DC voltage difference	1A	-	-	-	-	-	6V	2V	ON	OFF	OFF	OFF	1	V <sub>CC</sub>	Note39			0.3	V
V <sub>FF</sub>	Flip-flop drive voltage	2A 12A	D SG5 0dB	-	-	-	-	6V	-	ON	OFF	OFF	OFF	1	Variable	Note40				V
SS	Service switch operation	4 13 23	C SG2	-	-	-	-	6V	-	ON	ON	OFF	OFF	1	V <sub>CC</sub>	Note41				-
DBW	Demodulated output bandwidth	1 2 3	E SG8	-	-	-	-	6V	-	OFF	OFF	OFF	OFF	2	V <sub>CC</sub>	Note42	0.8	1.0		MHz
CD	Chroma input dynamic range	31	D SG5	-	-	-	-	6V	-	ON	OFF	OFF	OFF	1	V <sub>CC</sub>	Note43	1.0	1.4		V <sub>P-P</sub>
∠R-Y-P	PAL demodulated phase angle	1A	E SG8	-	-	-	-	6V	-	OFF	OFF	OFF	OFF	2	V <sub>CC</sub>	Note44		90		deg.
∠G-Y-P		2A 3A	4.53 MHz															240		deg.
∠R-Y-N	NTSC demodulated phase angle	1A	D	-	-	-	-	6V	2V	ON	OFF	OFF	ON	1	V <sub>CC</sub>	Note45		100		deg.
∠G-Y-N		2A 3A	SG9 0dB															240		deg.
T <sub>min</sub>	NTSC TINT	1A	D SG6	-	-	-	-	6V	Variable	ON	OFF	OFF	ON	1	V <sub>CC</sub>	Note46	-27	-47	-67	deg.
T <sub>max</sub>		2A	0dB															+20	+40	+60

\*: "-" indicates OPEN.

DEFLECTION SECTION

Symbol	Parameter	Test point	Input A	Test conditions *													Limits			Unit
				9	12A	14A	15A	V <sub>CC</sub>	22A	S6	S14	S16	S17	S22	S24-1	S15	Note	Min.	Typ.	
I <sub>CC</sub> - J	Circuit current	A2	SGa	-	V <sub>CC</sub>	6V	GND	-	ON	OFF	1	OFF	OFF	OFF	OFF		19	28	37	mA
V <sub>Bmin</sub>	Horizontal oscillator starting voltage	6	-	-	V <sub>CC</sub>	6V	GND	Variable	-	ON	OFF	3	OFF	OFF	OFF	Note47		5.2	6.2	V
f <sub>H</sub>	Horizontal free run frequency	6	-	-	V <sub>CC</sub>	6V	GND	-	ON	OFF	3	OFF	OFF	OFF	OFF		15.45	15.625	15.8	kHz
f <sub>PH1L</sub>	Horizontal pull-in range - 1	6	SGb	6V	V <sub>CC</sub>	6V	GND	-	ON	OFF	1	OFF	OFF	OFF	OFF	Note48		-970	-600	Hz
f <sub>PH1H</sub>																		+550	+900	Hz
f <sub>PH2L</sub>	Horizontal pull-in range - 2	6	SGb	6V	V <sub>CC</sub>	6V	GND	-	ON	OFF	1	OFF	ON	OFF	OFF	Note49		-1100	-700	Hz
f <sub>PH2H</sub>																		+650	+1000	Hz
V <sub>TR SW</sub>	VCR switch threshold voltage	6 22	SGb	-	V <sub>CC</sub>	6V	GND	Variable	ON	OFF	1	OFF	OFF	OFF	OFF	Note50	5	5.5	6	V
V <sub>9H</sub>	Agreement detection maximum voltage	9	SGa	-	V <sub>CC</sub>	6V	GND	-	ON	OFF	1	OFF	OFF	OFF	OFF		10.5	11.3		V
V <sub>9L</sub>	Agreement detection minimum voltage	9	-	-	V <sub>CC</sub>	6V	GND	-	ON	OFF	3	OFF	OFF	OFF	OFF				0.5	V
τ <sub>H</sub>	Horizontal output pulse amplitude	6	SGa	-	V <sub>CC</sub>	6V	GND	-	ON	OFF	1	OFF	OFF	OFF	OFF	Note51	21	25	29	μ sec
V <sub>Hmin</sub>	Horizontal output voltage	6	SGa	-	V <sub>CC</sub>	6V	GND	-	OFF	OFF	1	OFF	OFF	OFF	OFF	Note52		0.04	0.16	V
V <sub>Hmax</sub>																		3.1	3.95	4.8
t <sub>GP</sub>	Burst gate pulse position	12	SGa	-	V <sub>CC</sub>	6V	GND	-	ON	OFF	1	OFF	OFF	OFF	OFF	Note53	3.7	4.7	5.7	μ sec
f <sub>V50</sub>	Vertical free run frequency	13	-	-	V <sub>CC</sub>	6V	GND	-	ON	OFF	3	OFF	OFF	OFF	OFF		43	44.4	46	Hz
f <sub>V60</sub>	Vertical free run frequency	13	-	-	V <sub>CC</sub>	6V	GND	-	ON	OFF	3	ON	OFF	OFF	OFF		50.5	52.8	55	Hz
f <sub>PV50</sub>	Vertical pull-in range	13	SGc	-	V <sub>CC</sub>	6V	GND	-	ON	OFF	1	OFF	OFF	OFF	OFF	Note54	54	55.7	58	Hz
f <sub>PV60</sub>	Vertical pull-in range	13	SGc	-	V <sub>CC</sub>	6V	GND	-	ON	OFF	1	ON	OFF	OFF	OFF	Note55	65	66.3	69	Hz
τ <sub>V50</sub>	Vertical output pulse amplitude	13	-	-	V <sub>CC</sub>	6V	GND	-	ON	OFF	3	OFF	OFF	OFF	OFF	Note56	474	544	614	μ sec
τ <sub>V60</sub>	Vertical output pulse amplitude	13	-	-	V <sub>CC</sub>	6V	GND	-	ON	OFF	3	ON	OFF	OFF	OFF	Note57	474	544	614	μ sec

\*: "-" indicates OPEN.

PAL/NTSC VIDEO CHROMA DEFLECTION

DEFLECTION SECTION (cont.)

Symbol	Parameter	Test point	Input A	Test conditions *														Limits			Unit
				9	12A	14A	15A	Vcc	22A	S6	S14	S16	S17	S22	S24-2	S15	Note	Min.	Typ.	Max.	
VV <sub>max</sub>	Vertical output maximum voltage	13	SGa	-	Vcc	6V	GND	-	ON	OFF	1	OFF	OFF	OFF	OFF	OFF	Not68	3.2	4.2		Vo-P
VV <sub>min</sub>	Vertical output minimum voltage	13	SGa	-	Vcc	6V	GND	-	ON	OFF	1	OFF	OFF	OFF	OFF	OFF	Not69			0.3	V
PRamp	Ramp peak voltage	15	SGa	-	Vcc	6V	-	-	ON	OFF	1	OFF	OFF	OFF	ON	Not70	6.4	6.8	7.2	V	
VRamp	Ramp amplitude	15	SGa	-	Vcc	6V	-	-	ON	OFF	1	OFF	OFF	OFF	ON	Not71	1.5	1.8	2.1	VP-P	
G <sub>VV</sub>	Vertical open loop gain	13	B SGd	-	Vcc	14A 5V	5V	-	ON	ON	3	OFF	OFF	ON	OFF	Not72	16	20	24	dB	
I <sub>SS</sub>	Sync separation input sensitivity current	12	-	-	Vcc	6V	GND	-	ON	OFF	2	OFF	OFF	OFF	OFF	Not73	0.07	0.1	0.15	mA	
T <sub>BGP1</sub>	Burst gate pulse timing - 1	12	SGa	-	Vcc	6V	GND	-	ON	OFF	1	OFF	OFF	OFF	OFF	Not74	0.35	0.5	0.7	μ sec	
T <sub>BGP2</sub>	Burst gate pulse timing - 2	12	SGa	-	Vcc	6V	GND	-	ON	OFF	1	OFF	OFF	OFF	OFF	Not75	3.2	3.6	4.1	μ sec	
V <sub>FBP</sub>	Flyback pulse clamp voltage	12	SGa	-	Vcc	6V	GND	-	ON	OFF	1	OFF	OFF	OFF	OFF	Not76	5.0	5.5	6.0	V	
V <sub>BGP</sub>	Burst gate pulse voltage	12	SGa	-	Vcc	6V	GND	-	ON	OFF	1	OFF	OFF	OFF	OFF	Not77	10.5	11.0	11.5	V	
AFC2 <sub>min</sub>	AFC2 interlock range	6	-	-	-	6V	GND	-	OFF	OFF	3	OFF	OFF	OFF	OFF	Not78		0.8	4	μ sec	
AFC2 <sub>max</sub>		12B	-	-	-	6V	GND	-	OFF	OFF	3	OFF	OFF	OFF	OFF	Not78	12	20		μ sec	
AFC2G	AFC2 loop gain	6 12B 12	-	-	-	6V	GND	-	OFF	OFF	3	OFF	OFF	OFF	OFF	Not79	34	41	49	dB	

\* : "-" indicates OPEN.

ELECTRICAL CHARACTERISTICS TEST METHOD

Video Section

Note1. Maximum Output "Y<sub>max</sub>"

- a. Test amplitude when not V blanking. Wave form should be distorted at this time.

Note2. Video Amplifier Gain "GY"

- a. Test amplitude when not V blanking and make V<sub>co</sub> the testing value.
- b.  $GY = 20 \times \log \frac{V_{co} (mV_{P-P})}{200 (mV_{P-P})} (dB)$

Note3. Contrast Control Characteristics-1 "GY<sub>mid</sub>"

- a.  $GY_{mid} = V_{co} (V_{P-P})$

Note4. Contrast Control Characteristics-2 "GY<sub>min</sub>"

- a. Test amplitude when not V blanking and make V<sub>c1</sub> the testing value.
- b.  $GY_{min} = 20 \times \log \frac{V_{c1}}{V_{co}} (dB)$

Note5. Contrast Control Characteristics-3 "GY<sub>max</sub>"

- a. Test amplitude when not V blanking and make V<sub>c2</sub> the testing value.
- b.  $GY_{mid} = 20 \times \log \frac{V_{c2}}{V_{co}} (dB)$

Note6. Video Tone Characteristics-1 "YT<sub>mid</sub>"

- a. Test amplitude when not V blanking and make V<sub>to</sub> the testing value.
- b.  $YT_{mid} = V_{to} (V_{P-P})$

Note7. Video Tone Characteristics-2 "YT<sub>min</sub>"

- a. Test amplitude when not V blanking and make V<sub>T1</sub> the testing value.
- b.  $YT_{min} = 20 \times \log \frac{V_{T1}}{V_{to}} (dB)$

Note8. Video Tone Characteristics-3 "YT<sub>max</sub>"

- a. Test amplitude when not V blanking and make V<sub>T2</sub> the testing value.
- b.  $YT_{max} = 20 \times \log \frac{V_{T2}}{V_{to}} (dB)$

Note9. Peaking Value "YP"

- a. Test amplitude when not V blanking.
- b. Make V<sub>P1</sub> the testing value when SG2 is input.
- c. Make V<sub>P2</sub> the testing value when SG3 is input.
- d.  $YP = 20 \times \log \frac{V_{P2}}{V_{P1}} (dB)$

Note10. Brightness Control Characteristics-1 "Y<sub>BRTmid</sub>"

- a. Test DC voltage when not V blanking.

Note11. Brightness Control Characteristics-2 "Y<sub>BRTmin</sub>"

- a. Same as Note10.

## M51390ASP

## PAL/NTSC VIDEO CHROMA DEFLECTION

**Note12. Brightness Control Characteristics-3 "Y<sub>BRTmax</sub>"**

- a. Same as Note10.

**Note13. Frequency Characteristics "Y<sub>f</sub>"**

- a. Test amplitude when not V blanking.  
 b. Make V<sub>r1</sub> the testing value when SG2 is input.  
 c. Make V<sub>r2</sub> the testing value when SG3 is input.

$$d. Y_f = 20 \times \log \frac{V_{r2}}{V_{r1}} \text{ (dB)}$$

**Note14. Differential Gain "DG"**

- a. Test amplitude when not V blanking.  
 b. Make V<sub>G1</sub> the testing value when 2.7V is input into pin ⑨.  
 c. Make V<sub>G2</sub> the testing value when 2.0V is input into pin ⑩.

$$d. DG = x \frac{|V_{G1} - V_{G2}|}{V_{G2}} \times 100 \text{ (%)}$$

**Note15. Horizontal Blanking Threshold Voltage "H<sub>BLKTH</sub>"**

- a. Apply voltage to pin ④ and increase from 8V.  
 b. Test the voltage of pin ④ when signal ceases to be output by 1A.

**Note16. Vertical Blanking Voltage "V<sub>V-BLK</sub>"**

- a. Test DC voltage during V blanking.

**Chroma Section****Note17. Chroma Maximum Gain "GC"**

- a. Test output amplitude (P-P) and make V<sub>GC</sub> the testing value.

$$b. GC = 20 \times \log \frac{V_{GC} \text{ (mV}_{P-P})}{\text{Input amplitude (=7.94mV}_{P-P})} \text{ (dB)}$$

**Note18. ACC Characteristics-1 "ACC1"**

- a. Test output amplitude (P-P).  
 b. Make V<sub>A0</sub> the testing value when SG5 0dB is input.  
 c. Make V<sub>A1</sub> the testing value when SG5 - 22dB is input.

$$d. ACC1 = 20 \times \log \frac{V_{A1}}{V_{A0}} \text{ (dB)}$$

**Note19. ACC Characteristics-2 "ACC2"**

- a. In the same manner as in Note18, make V<sub>A2</sub> the testing value when SG5 + 6dB is input.

$$b. ACC2 = 20 \times \log \frac{V_{A2}}{V_{A0}} \text{ (dB)}$$

**Note20. Killer Operation Input "KIL"**

- a. Gradually attenuate the level of SG5.  
 b. While monitoring DC voltage of pin ⑩, input level of SG5 when voltage becomes less than 1V.

**Note21. Killer Color Residual "D.KIL"**

- a. Test output amplitude within 1H interval.

**Note22. Color Control Characteristics-1 "CC<sub>mid</sub>"**

- a. Test output amplitude (P-P) and make V<sub>C10</sub> the testing value.  
 b. CC<sub>mid</sub> = V<sub>C10</sub> (V<sub>P-P</sub>)

**Note23. Color Control Characteristics-2 "CC<sub>min</sub>"**

- a. Test output amplitude (P-P) and make V<sub>C11</sub> the testing value.

$$b. CC_{min} = 20 \times \log \frac{V_{C11}}{V_{C10}} \text{ (dB)}$$

**Note24. Color Control Characteristics-3 "CC<sub>max</sub>"**

- a. Test output amplitude (P-P) and make V<sub>C12</sub> the testing value.

$$b. CC_{max} = 20 \times \log \frac{V_{C12}}{V_{C10}} \text{ (dB)}$$

**Note25. Color Tracking Characteristics-1 "UC<sub>mid</sub>"**

- a. Test output amplitude (P-P) and make V<sub>U0</sub> the testing value.

$$b. UC_{mid} = V_{U0} \text{ (V}_{P-P})$$

**Note26. Color Tracking Characteristics-2 "UC<sub>min</sub>"**

- a. Test output amplitude (P-P) and make V<sub>U1</sub> the testing value.

$$b. UC_{min} = 20 \times \log \frac{V_{U1}}{V_{U0}} \text{ (dB)}$$

**Note27. Color Tracking Characteristics-3 "UC<sub>max</sub>"**

- a. Test output amplitude (P-P) and make V<sub>U2</sub> the testing value.

$$b. UC_{max} = 20 \times \log \frac{V_{U2}}{V_{U0}} \text{ (dB)}$$

**Note28. APC Pull-In Range-1 "APC1"**

- a. Set so that the frequency of SG6 is less than 4.433MHz and pin ⑩ is Lo.

- b. Gradually increase the frequency of SG6.

- c. Test the frequency when the voltage of pin ⑩ changes from Lo to Hi and make F<sub>AU</sub> the testing value.

$$d. APC1 = 4433619 \text{ (Hz)} - F_{AU} \text{ (Hz)}$$

**Note29. APC Pull-In Range-2 "APC2"**

- a. Set so that the frequency of SG6 is more than 4.434MHz and pin ⑩ is Lo.

- b. Gradually decrease the frequency of SG6.

- c. Test the frequency when the voltage of pin ⑩ changes from Lo to Hi and make F<sub>AD</sub> the testing value.

$$d. APC2 = F_{AD} \text{ (Hz)} - 4433619 \text{ (Hz)}$$

**Note30. Demodulated Output DC Voltage "D<sub>DC</sub>"**

- a. Test DC voltage at 1A, 2A, and 3A.

**Note31. Demodulated Output DC Offset "D<sub>Offset</sub>"**

- a. Calculate each voltage difference of 1A2A, 2A3A, 3A1A from the testing value of Note30.

**Note32. Demodulation Ratio-1 "R/B"**

- a. Test output amplitude and make D<sub>R-Y</sub> the testing value.

$$b. R/B = \frac{D_R - Y}{D_B - Y}$$

PAL/NTSC VIDEO CHROMA DEFLECTION

**Note33. Demodulation Ratio-2 "G/B"**

- a. Test output amplitude and make  $D_G - Y$  the testing value.
- b.  $G/B = \frac{D_G - Y}{D_B - Y}$

**Note34. Demodulated Output 1H Level Difference "ΔD/H"**

- a. Test both AC, DC for each 1H level difference.

**Note35. Demodulated Output Carrier Leak "Cleak"**

- a. Test output carrier element for 1A, 2A, and 3A.

**Note36. NTSC Operation Control Voltage "V<sub>NTSC</sub>"**

- a. Gradually decrease voltage of 29A from the area of 8V.
- b. Test the 29A voltage when signal ceases to be output by 1A.

**Note37. Demodulation Ratio (NTSC) - 1 "NTSC R/B"**

- a. Test output amplitude and make  $NTSC_R$  the testing value.
- b.  $NTSC\ R/B = \frac{NTSC_R}{NTSC_B}$

**Note38. Demodulation Ratio (NTSC) - 2 "NTSC G/B"**

- a. Test output amplitude and make  $NTSC_G$  the testing value.
- b.  $NTSC\ G/B = \frac{NTSC_G}{NTSC_B}$

**Note39. PAL/NTSC Demodulated Output DC Voltage Difference "V<sub>P/N</sub>"**

- a. Test the difference in DC voltage when  $S_{29}$  is on and when it is off.

**Note40. Flip-Flop Drive Voltage "V<sub>FF</sub>"**

- a. Gradually decrease voltage of 12A from the area of 7V.
- b. Test the 12A voltage when the 2A output flip-flops for each 1H.

**Note41. Service Switch Operation "SS"**

- a. No output signal from ④
- b. No vertical sync pulse from ⑬
- c. Voltage of ⑫ drops below 1V.
- d. Check a, b, and c.

**Note42. Demodulated Output Bandwidth "D<sub>BW</sub>"**

- a. Set frequency of  $SG_8$  to 4.5MHz, and test output amplitude of ①, ② and ③.
- b. Gradually increase the frequency of  $SG_8$ .
- c. Test output frequency of ①, ② and ③ when output amplitude is 3 dB less than when 4.5MHz is input.

**Note43. Chroma Input Dynamic Range "CD"**

- a. Increase the level of  $SG_5$  and test the input amplitude when output becomes distorted.

**Note44. PAL Demodulated Phase Angle "∠R-Y-P, ∠G-Y-P"**

- a. Make ∠R-Y-P the phase difference of 1A2A.
- b. Make ∠G-Y-P the phase difference of 1A3A.

**Note45. NTSC Demodulated Phase Angle "∠R-Y-N, ∠G-Y-N"**

- a. Make ∠R-Y-N the phase difference of 1A2A.
- b. Make ∠G-Y-N the phase difference of 1A3A.

**Note46. NTSC Tint "T<sub>min</sub>, T<sub>max</sub>"**

- a. Set oscilloscope to X-Y. Connect 1A to X and 2A to Y.
- b. Open 29A and set  $SG_6$  frequency to 4.433619MHz.
- c. At this time the oscilloscope waveform is shown as 180°.
- d. Make  $T_{min}$  the remainder of subtracting 180° from the angle when 29A was set to 4V.
- e. Make  $T_{max}$  the remainder of subtracting 180° from the angle when 29A was set to 1V.

**Deflection Section**

**Note47. Horizontal Oscillator Starting Voltage "V<sub>min</sub>"**

- a. Increase  $V_{CC}$  from 0V.
- b. Test  $V_{CC}$  voltage where the output waveform cycle of ⑥ is approx. 64μsec.

**Note48. Horizontal Pull-In Range-1 "f<sub>PH1L</sub>, f<sub>PH1H</sub>"**

- a. Decrease the frequency of input signal so that the  $SG_B$  input signal and pin ⑥ output waveform are not synchronized.
- b. Increase the frequency of  $SG_B$ .
- c. Test the  $SG_B$  frequency when  $SG_B$  and pin ⑥ output waveform become synchronized and make  $f_{L1}$  the testing value.
- d.  $f_{PH1L} = f_{L1} - f_H$
- e. Test the upper side pull-in in the same manner and make  $f_{H1}$  the  $SG_B$  frequency when the two become synchronized.
- f.  $f_{PH1H} = f_{H1} - f_H$ .

**Note49. Horizontal Pull-In Range-2 "f<sub>PH2L</sub>, f<sub>PH2H</sub>"**

- a. Test in the same manner as Note48 and make  $f_{L2}$  the lower side pull-in frequency, and make  $f_{H2}$  the upper side pull-in frequency.
- b.  $f_{PH2L} = f_{L2} - f_H$
- c.  $f_{PH2H} = f_{H2} - f_H$

**Note50. VCR Switch Threshold Voltage "V<sub>TR SW</sub>"**

- a. Set  $SG_B$  frequency of Note48 immediately preceding pull-in.
- b. Increase 22A voltage from 6V and test voltage of pin ② at time of pull-in.

**Note51. Horizontal Output Pulse Amplitude "τ<sub>H</sub>"**

**Note52. Horizontal Output Voltage "V<sub>Hmin</sub>, V<sub>Hmax</sub>"**

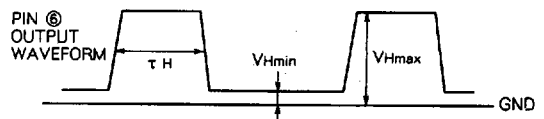



# M51390ASP

## PAL/NTSC VIDEO CHROMA DEFLECTION

**Note53. Burst Gate Pulse Position "tGP"**

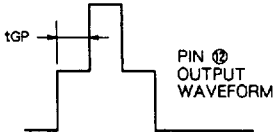

**Note54. Vertical Pull-In Range 50 (Hz) "fv50"**

- Increase the frequency of input signal so that the SGC input signal and pin 13 output waveform are not synchronized.
- Decrease the frequency of SGC and test the SGC frequency when SGC and the output waveform of pin 13 become synchronized.

**Note55. Vertical Pull-In Range 60 (Hz) "fv60"**

- Same as Note54.

**Note56. Vertical Output Pulse Amplitude 50 (Hz) "tv50"**

**Note57. Vertical Output Pulse Amplitude 60 (Hz) "tv60"**

**Note58. Vertical Output Maximum Voltage "Vvmax"**

**Note59. Vertical Output Minimum Voltage "Vvmin"**

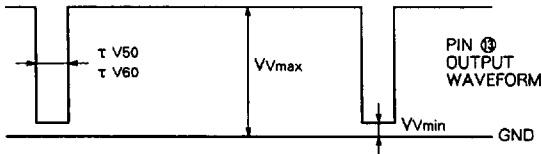

**Note60. Ramp Peak Voltage "PRamp"**

**Note61. Ramp Amplitude "VRamp"**

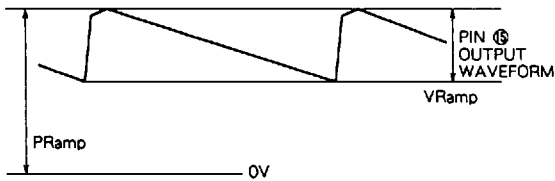

**Note62. Vertical Open Loop Gain "Gv"**

- Test the output amplitude of pin 13 and make V<sub>vo</sub> the testing value.
- $$G_v = 20 \times \log \frac{V_{vo} \text{ (mV}_{P-P})}{\text{Input Amplitude (}=50\text{mV}_{P-P})} \text{ (dB)}$$

**Note63. Sync Separation Input Sensitivity Current "Iss"**

- Increase I<sub>s</sub> from 0 mA.
- Test I<sub>s</sub> when burst gate pulse ceases to be output by ⑫.

**Note64. Burst Gate Pulse Timing-1 "TBP1"**

- Test the time from SGA rise to burst gate pulse rise.

**Note65. Burst Gate Pulse Timing-2 "TBP2"**

- Test burst gate pulse amplitude.

**Note66. Flyback Pulse Clamp Voltage "VFBP"**

**Note67. Burst Gate Pulse Voltage "VBGP"**

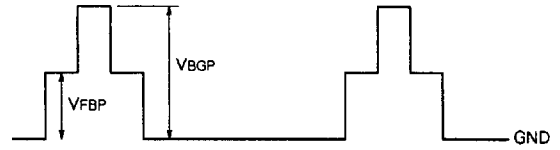

**Note68. AFC2 Interlock Range "AFC2min, AFC2max"**

- Trigger external pulse generator by pin 16 output.
- Generate flyback pulse with external pulse generator, and input to 12B.
- While gradually decreasing the pulse generator's pulse delay, when the position of pin 12 waveform largely differs from the output waveform of pin 16, make AFC<sub>2min</sub> the time between 16 rise and flyback pulse rise.
- Increasing the pulse generator's pulse delay, test in the same manner to find the value of AFC<sub>2max</sub>.

**Note69. AFC2 Loop Gain "AFC2G"**

- Test the burst gate pulse position (t<sub>GP</sub>) at AFC<sub>2min</sub> of Note68 + 1μs, and make t<sub>GPmin</sub> the testing value.
- Test the burst gate pulse position at AFC<sub>2max</sub> - 1μs and make t<sub>GPmax</sub> the testing value.
- $$AFC2G = 20 \times \log \frac{AFC2_{max} - AFC2_{min} - 2 \text{ (}\mu\text{ sec)}}{t_{GPmin} - t_{GPmax} \text{ (}\mu\text{ sec)}}$$

**Precautions Concerning Electrical Characteristics**

- Adjust the one-shot multivibrator's potentiometer so that the timing of the horizontal input flyback pulse of pin 12 and pulse amplitude are as shown in the figure below.
- Standard Conditions of Deflection Section for Testing Video/Chroma Sections

Input A	9	14A	15A	Vcc	S6	S14	S16	S17	S22	S15
SGa	-	6V	GND		ON	OFF	1	OFF	OFF	OFF

"-" indicates OPEN.

- Standard Conditions of Video/Chroma Sections for Testing Deflection Section

Input C,D,E	17A	19	20A	23A	25A	29A	S24-1	S26	S29	S32
	-	-	6V	-	6V	-	ON	OFF	OFF	1

"-" indicates OPEN.

- Unless designated otherwise, V<sub>cc</sub> = 12V, T<sub>a</sub> = 25°C.

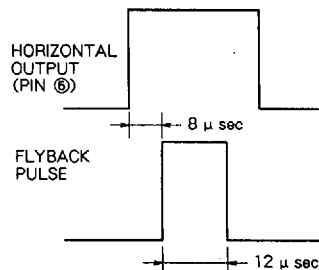

# M51390ASP

## PAL/NTSC VIDEO CHROMA DEFLECTION

### INPUT SIGNAL

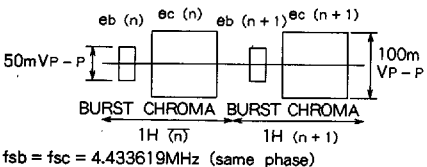
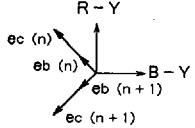
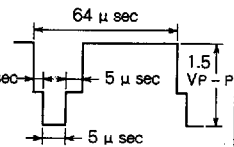
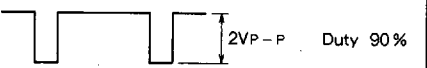
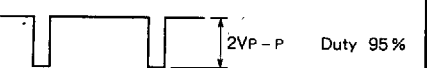
SG No.	Signal contents
SG1	100kHz CW 3VP-P
SG2	100kHz CW 200mVP-P
SG3	2MHz CW 200mVP-P
SG4	5MHz CWCW 200mVP-P
SG5	<p>PAL simple chroma signal</p>  <p>The correlation of phases for the signals given above is shown in the figure on the right. The phase correlation with burst of <math>ec(n)</math> and <math>ec(n+1)</math> does not always have to be as shown in the figure on the right, especially because the phases of burst signal and chroma signal are mutually adjustable when testing phase correlation.</p> 
SG6	With chroma signals for SG5, the phase of burst and chroma signals should be the same and the frequency should be adjustable.
SG7	4.42MHz CW 0.2~0.5VP-P
SG8	4.5~6MHz CW
SG9	Under the SG5 conditions $fsb$ (burst) = 4.433619MHz, $fsc$ (chroma) = 4.53MHz
SGa	<p>Input for sync separation should be PAL 100% standard combined image signal 1.5VP-P 2μsec for PAL system such as illustrated by the figure on the right.</p> 
SGb	 <p>2VP-P Duty 90%</p>
SGc	 <p>2VP-P Duty 95%</p>
SGd	2kHz CW 500mVP-P = 0dB

### INPUT IMPEDANCE MEASURING CIRCUIT

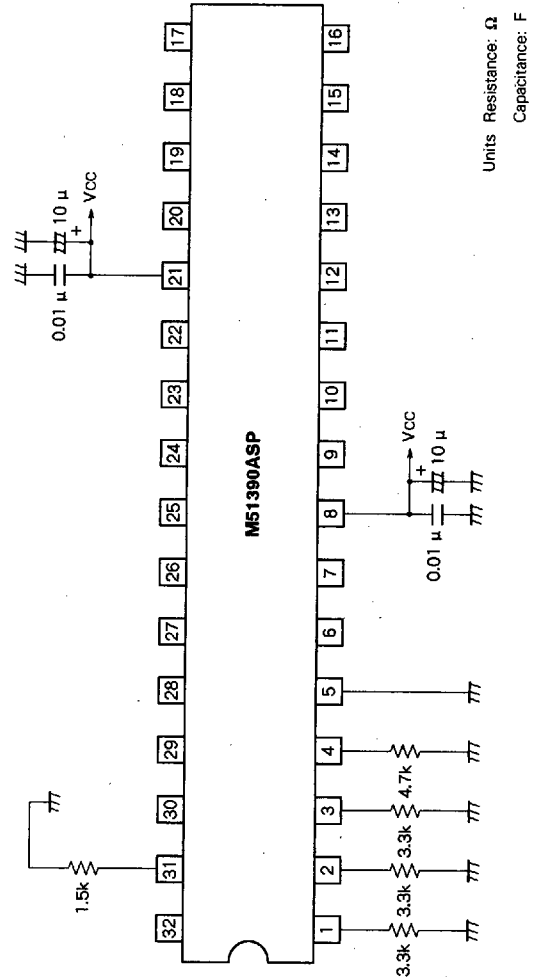



**TYPICAL CHARACTERISTICS**

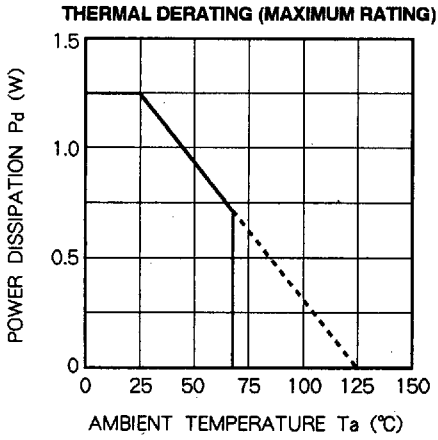



# M51390ASP

## PAL/NTSC VIDEO CHROMA DEFLECTION

### FUNCTIONS

Three types of similar functions are available for this LSI semiconductor integrated circuit. The differences of the three types are as described below.

	M51308SP	M51390ASP	M51412SP
Color demodulation ratio	Conforms with CCIR	Red is more pronounced than M51308SP	
Luminance control polarity	Becomes brighter as control voltage is increased.	Becomes darker as control voltage is decreased.	
Horizontal output pulse amplitude	24 $\mu$ sec		26 $\mu$ sec
Vertical system	Sampling DC feedback system high gain (50dB)	Ramp generation system low gain (20dB)	Sampling DC feedback system low gain (20dB)

### PRECAUTIONS FOR APPLICATION

- Usage where voltage drops below grounding voltage, even if instantaneous, should be avoided. With the exception of pin ⑭, usage where voltage exceeds supply voltage, even if instantaneous, should be avoided. Pin ⑭ must be used at  $(0.28V_{cc} + 6)$  V or less.
- Recommended supply voltage is 12V, and recommended operating ambient temperature is 25°C. If used outside of these provisions, usage conditions and component constant that satisfy requirements for IC disparity and temperature characteristics must be selected.
- A component whose value is not subject to change within applied voltage range and whose capacitance does not fluctuate greatly due to temperature change must be used for the capacitor that determines the voltage and timing for external components of the deflection system. Caution is required concerning the power source and grounding pattern in order to avoid influence of power ripple and interference between vertical and horizontal.
- For power supply pin, DC control pin, and unused pins, an approximately 0.01 $\mu$ F capacitor with good high frequency characteristics should be set between respective pins and ground as a bypass capacitor.

If the conditions listed above cannot be satisfied, contact us for consultation.