

# M51545P

3V DUAL PREAMPLIFIER WITH ALC

## DESCRIPTION

The M51545P is a semiconductor integrated circuit designed for use as a low-voltage preamplifier in micro or compact cassette tape recorder equipment.

It incorporates two low-noise preamplifiers, ALC driver circuit and ALC rectifier circuit. In addition, the turn point (the output level at which ALC starts to gain control) can be set by only changing the externally connected resistors.

## FEATURES

- Built-in dual preamplifiers with good matching characteristics, ALC circuit and rectifier circuit, housed in 16-pin flat package.
- Internal rectifier circuit eliminates externally connected diodes and also enables ALC performance at a low voltage ( $V_{CC} = 1.9V$ ).
- The turn point can be set by changing only the externally connected resistors.
- Input coupling capacitors are not required.
- Low noise Input-referred noise  $1.0\mu V_{rms}$  typ. ( $R_0 = 620\Omega$ )
- High gain Open loop voltage gain 90 dB typ. ( $R_L = 4.7k\Omega$ ,  $f = 1kHz$ )

## APPLICATION

Compact stereo cassette tape recorder, Micro cassette tape recorder

## RECOMMENDED OPERATING CONDITIONS

Supply voltage range ..... 1.9~6.0V  
 Rated supply voltage ..... 3.0V

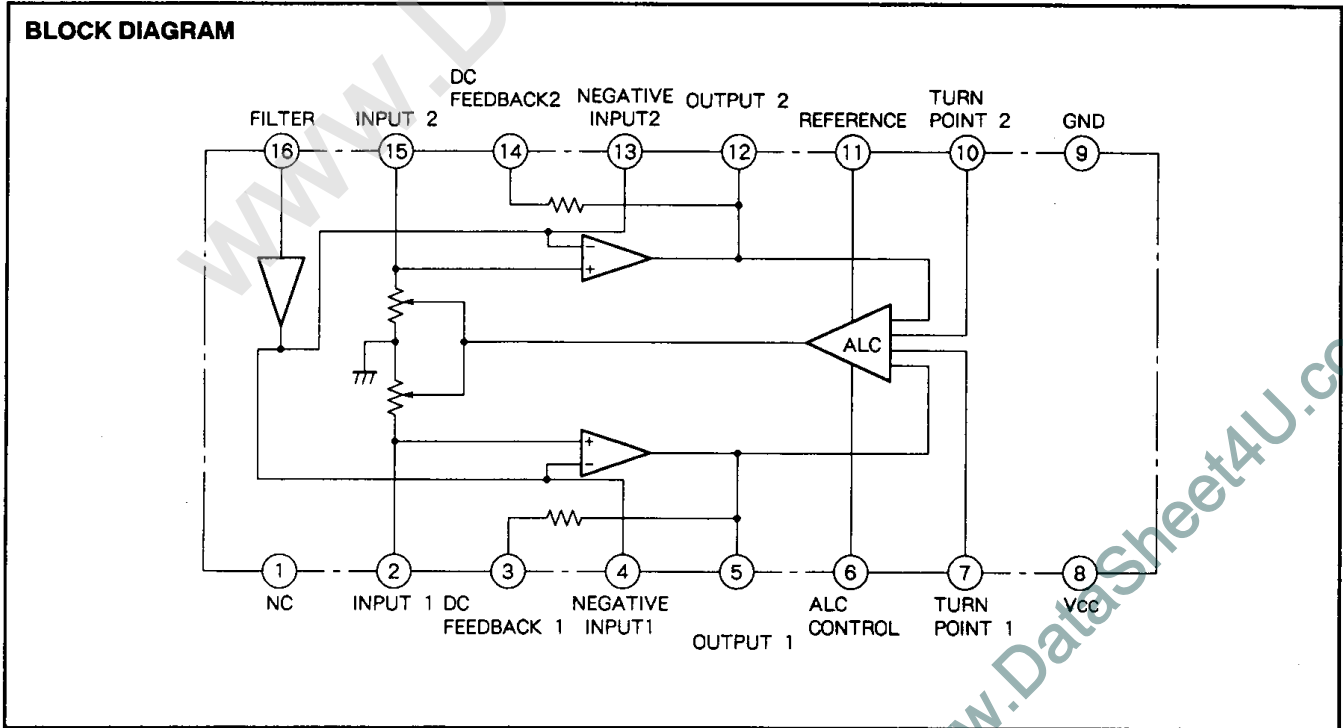
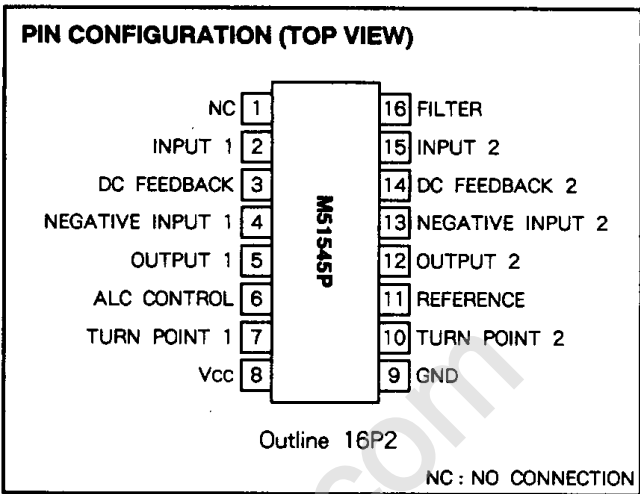

**ABSOLUTE MAXIMUM RATINGS** (Ta = 25 °C, unless otherwise noted)

Symbol	Parameter	Conditions	Ratings	Unit
Vcc	Supply voltage		7	V
Icc	Circuit current		50	mA
Pd	Power dissipation		300	mW
Ke	Thermal derating	Ta ≥ 25 °C	3	mW/°C
Topr	Operating temperature		- 20 ~ + 75	°C
Tstg	Storage temperature		- 40 ~ + 125	°C

**ELECTRICAL CHARACTERISTICS** (Vcc = 3V, Rg = 2kΩ, RL = 4.7kΩ, Ta = 25 °C, unless otherwise noted)

Symbol	Parameter	Test conditions	Limits			Unit
			Min	Typ	Max	
Icco	Quiescent circuit current	Zero signal condition		4.7	9	mA
Gvc	Voltage gain	f = 1kHz	44	46	48	dB
Vomax	Maximum output voltage	f = 1kHz, THD = 3%	0.6	0.8		Vrms
THD	Total harmonic distortion	f = 1kHz, Vo = 0.4Vrms		0.2	0.8	%
Rin	Input resistance	f = 1kHz, Vo = 0.4Vrms	30	80		kΩ
No	Output noise voltage	Rg = 620Ω, BW = 20Hz~20kHz		0.2	1	mVrms
ALC	ALC range	Measure the input range from the start of ALC till the output distortion becomes 10% with f = 1kHz.	40	54		dB
BALC	ALC balance	f = 1kHz, Vi = - 30dBm		0	3	dB
THDALC	Total harmonic distortion	f = 1kHz, Vi = - 30dBm		0.3	1.2	%

**TYPICAL CHARACTERISTICS**

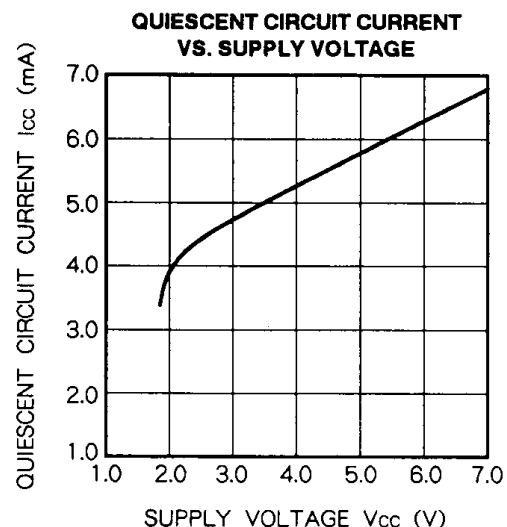
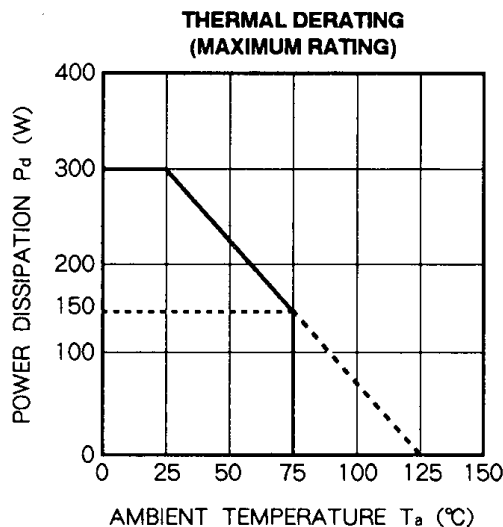

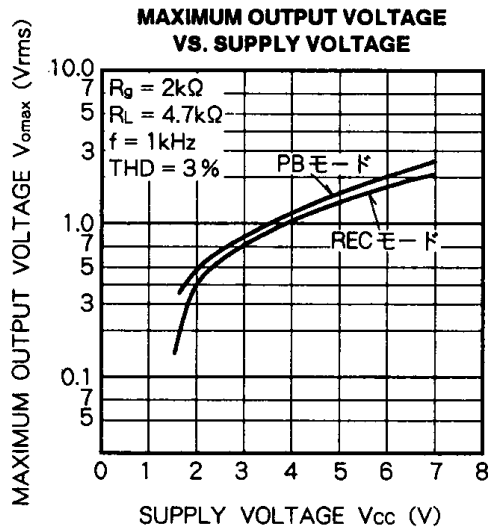
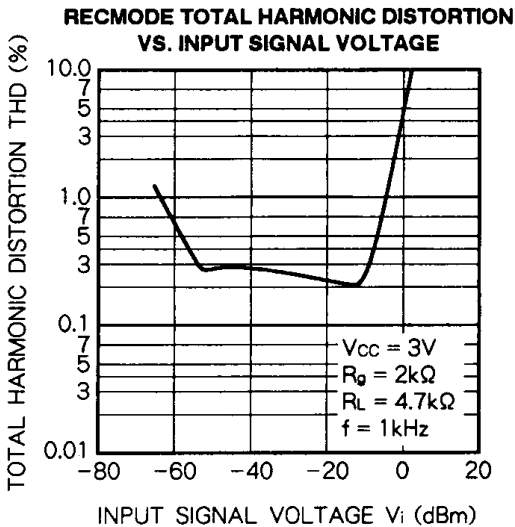
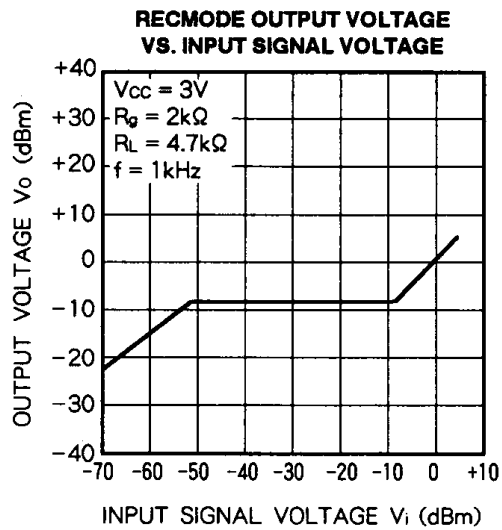
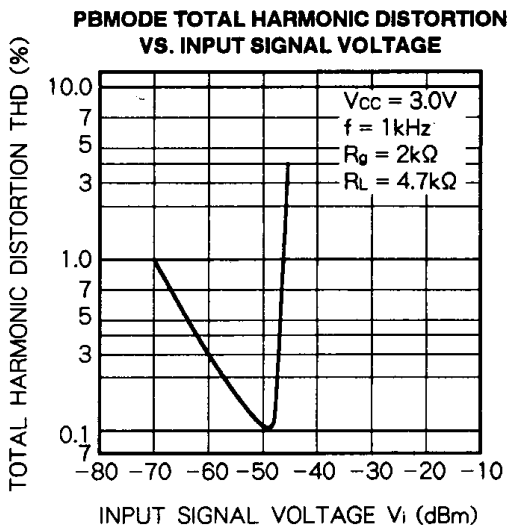
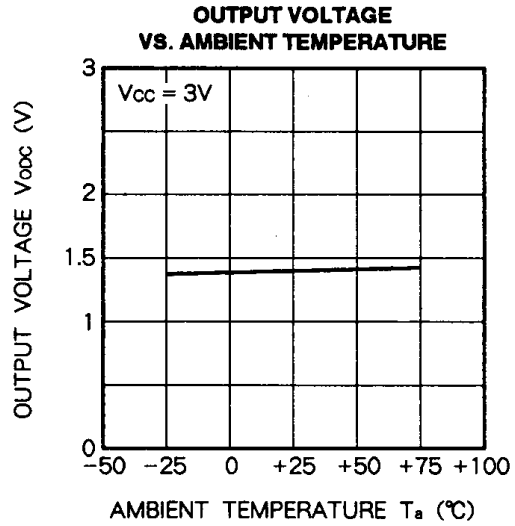
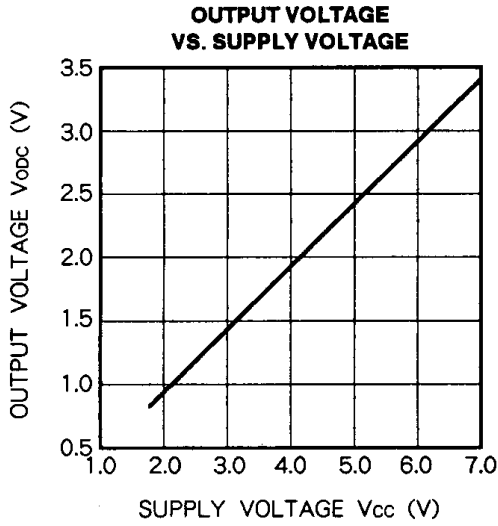

APPLICATION EXAMPLE

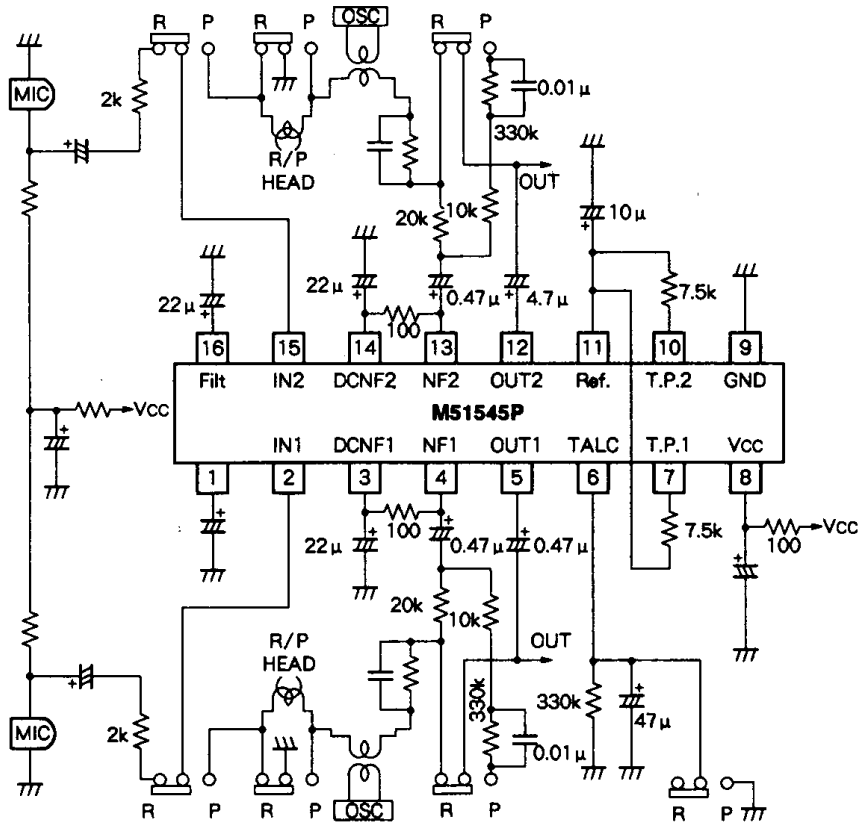

PCB FOR CIRCUIT TESTING  
(COPPER FOILSIDE)

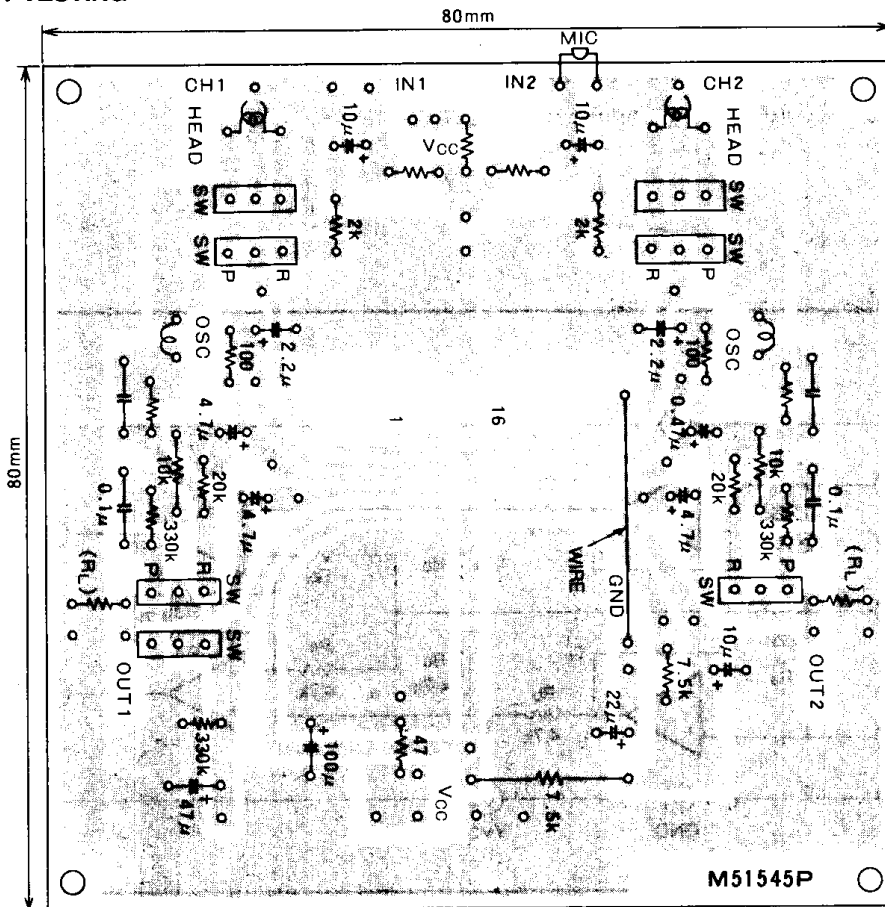

Units Resistance : Ω  
Capacitance : F

Units Resistance : Ω  
Capacitance : F