

M52023SP

NTSC VIDEO CHROMA DEFLECTION

DESCRIPTION

The M52023SP is semiconductor integrated circuit that processes video, color, and vertical/horizontal sync signals for NTSC system television sets of average class to top of the line.

FEATURES

- Equipped with delay-line contour adjustment for sharper images.
- Features improved 9 MHz (-3 dB) video signal circuit frequency characteristics for higher picture quality.
- IQ demodulator reproduces chroma difference signals with no deviation from the original. The M52023SP is also equipped with a built-in on-screen character display circuit, and because it facilitates connection with external RGB input, the number of external components required is dramatically reduced.
- Vertical and horizontal count-down by 32fH oscillator eliminates need for adjustment.
- Features selectable R-Y matrix ratio.

APPLICATION

NTSC System Color Televisions

RECOMMENDED OPERATING CONDITION

- Operating Supply Voltage 8.5~9.5V (Pin[Ⓞ])
- Rated Supply Voltage 9V (Pin[Ⓞ])
- Operating Supply Voltage 11.0~13.0V (Pin[Ⓞ])
- Rated Supply Voltage 12V (Pin[Ⓞ])
- Operating Input Current Range 20~35mA (Pin^⑦)
- Rated Input Current 25mA (Pin^⑦)

PIN CONFIGURATION (TOP VIEW)

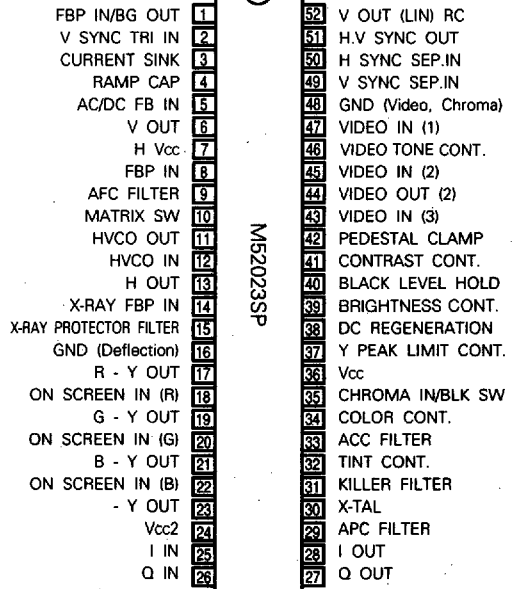

Outline 52P4B

NTSC VIDEO CHROMA DEFLECTION

BLOCK DIAGRAM

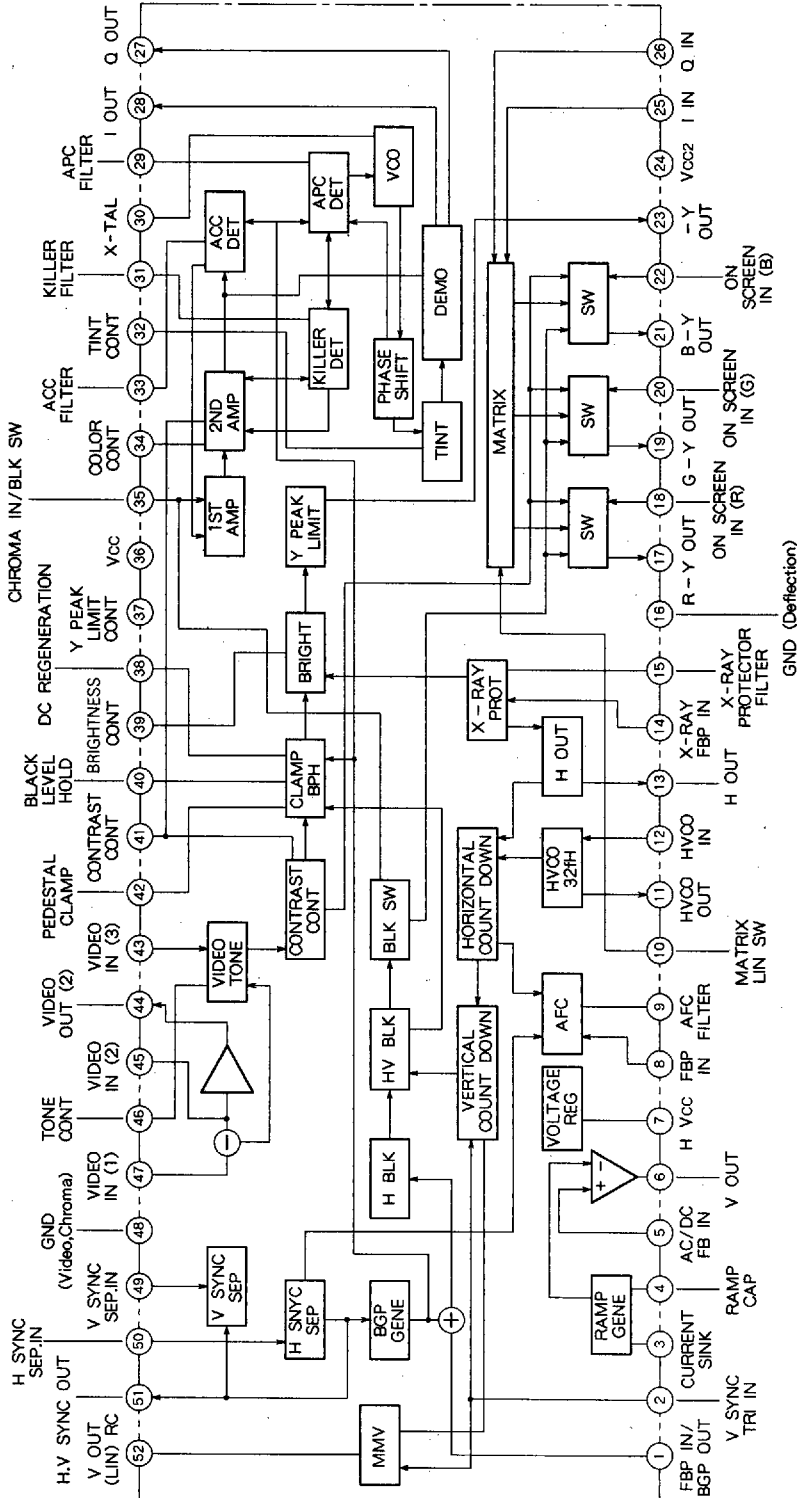

NTSC VIDEO CHROMA DEFLECTION

VIDEO/CHROMA SECTION (cont.)

Symbol	Parameter	Test point	Input (B)	Test conditions*																	Limits			Unit									
				18	20	22	24	32	34	35	36	37	39	40	41	42	46	S	S	S	S	S	S		S	SD	1A	Note	Min.	Typ.	Max.		
YDOBLK	DC playback ratio correction alteration characteristics	23	SG2	0V	0V	12V	-	-	-	9V	-	-	-	OP EN	-	3	3	OFF	OFF	ON	OFF	2	1	1	2	2	1	9V	20	0.05	0.1	0.2	V
YPLmid	Video peak limiter characteristics - 1	23	SG2	0V	0V	12V	-	-	-	9V	-	-	-	2.4V	-	3	3	OFF	OFF	OFF	OFF	2	1	1	2	2	1	9V	21	2.1	2.6	3.1	V _{O-P}
YPLmax	Video peak limiter characteristics - 2	23	SG2	0V	0V	12V	-	-	-	9V	-	-	-	2.4V	-	3	3	OFF	OFF	OFF	OFF	2	1	1	2	2	1	9V	22	4.7	5.2	5.7	V _{O-P}
V41	Pin ④ voltage	41	-	0V	0V	12V	-	-	-	9V	-	-	-	2.4V	-	3	3	OFF	OFF	OFF	OFF	2	1	2	2	2	1	9V		4.1	4.5	4.9	V
V46	Pin ⑥ voltage	46	-	0V	0V	12V	-	-	-	9V	-	-	-	2.4V	-	3	3	OFF	OFF	OFF	OFF	2	1	2	2	2	1	9V		4.1	4.5	4.9	V
TBLKV	V blanking amplitude	23	-	0V	0V	12V	-	-	-	9V	-	-	-	2.4V	-	3	3	OFF	OFF	OFF	OFF	2	1	2	2	2	1	9V	23	0.95	1.10	1.25	ms
Y8TH	Black level replacement threshold voltage	23	-	0V	0V	12V	-	-	-	9V	-	-	-	2.4V	-	3	3	OFF	OFF	OFF	OFF	2	1	2	2	2	1	9V	24	4.0	4.4	4.8	V
ACC1	ACC characteristics - 1	27A	SG5 -18dB	0V	0V	12V	-	-	-	9V	-	-	-	-	-	3	3	OFF	OFF	OFF	OFF	2	1	2	2	2	1	9V	25	-6	-3	0	dB
ACC2	ACC characteristics - 2	27A	SG5 -6dB	0V	0V	12V	-	-	-	9V	-	-	-	-	-	3	3	OFF	OFF	OFF	OFF	2	1	2	2	2	1	9V	26	-2	0	+2	dB
Comid	Color control variation characteristics - 1	27A	SG5	0V	0V	12V	-	4.5V	-	9V	-	-	-	-	-	3	3	OFF	OFF	OFF	OFF	2	1	2	2	2	1	9V	27	-3	0	+3	dB
Comin	Color control variation characteristics - 2	27A	SG5	0V	0V	12V	-	0V	-	9V	-	-	-	-	-	3	3	OFF	OFF	OFF	OFF	2	1	2	2	2	1	9V	28		-40	-30	dB
Comax	Color control variation characteristics - 3	27A	SG5	0V	0V	12V	-	9V	-	9V	-	-	-	-	-	3	3	OFF	OFF	OFF	OFF	2	1	2	2	2	1	9V	29	3	6	9	dB
Cumid	Color tracking variation characteristics - 1	27A	SG5	0V	0V	12V	-	-	-	9V	-	-	4.5V	-	-	3	3	OFF	OFF	OFF	OFF	2	1	2	2	2	1	9V	30	-3	0	+3	dB
Cumin	Color tracking variation characteristics - 2	27A	SG5	0V	0V	12V	-	-	-	9V	-	-	0V	-	-	3	3	OFF	OFF	OFF	OFF	2	1	2	2	2	1	9V	31		-40	-30	dB
Cumax	Color tracking variation characteristics - 3	27A	SG5	0V	0V	12V	-	-	-	9V	-	-	9V	-	-	3	3	OFF	OFF	OFF	OFF	2	1	2	2	2	1	9V	32	3	6	9	dB
fpc1	APC pull-in range - 1	27A	SG7	0V	0V	12V	-	-	-	9V	-	-	-	-	-	3	3	OFF	OFF	OFF	OFF	2	1	2	2	2	1	9V	33	200	750		Hz
fpc2	APC pull-in range - 2	27A	SG7	0V	0V	12V	-	-	-	9V	-	-	-	-	-	3	3	OFF	OFF	OFF	OFF	2	1	2	2	2	1	9V	34	200	750		Hz
KIL	Killer operation input level	27A	SG6 Variable	0V	0V	12V	-	-	-	9V	-	-	-	-	-	3	3	OFF	OFF	OFF	OFF	2	1	2	2	2	1	9V	35	-45	-39	-33	dB
DKIL	Killer color residual	27A	SG6 No burst	0V	0V	12V	-	-	-	9V	-	-	-	-	-	3	3	OFF	OFF	OFF	OFF	2	1	2	2	2	1	9V	36		60		mV _{P-P}
Cleak	Demodulated output carrier leak	27A	SG5	0V	0V	12V	-	-	-	9V	-	-	-	-	-	1	1	OFF	OFF	OFF	OFF	2	1	2	2	2	1	9V	37		200		mV _{P-P}
T	Tint control variance	17 21	SG6	0V	0V	12V	0V	9V	-	9V	-	-	-	-	-	1	1	OFF	OFF	OFF	OFF	2	1	2	2	2	1	9V	38	70	90	110	deg.
Tmin	Tint control characteristics - 1	17 21	SG6	0V	0V	12V	-	-	-	9V	-	-	-	-	-	1	1	OFF	OFF	OFF	OFF	2	1	2	2	2	1	9V	39	-70	-50	-30	deg.
Tmax	Tint control characteristics - 2	17 21	SG6	0V	0V	12V	-	-	-	9V	-	-	-	-	-	1	1	OFF	OFF	OFF	OFF	2	1	2	2	2	1	9V	40	23	43	63	deg.
QIR	Demodulated phase angle - 1	27A 28A	SG8	0V	0V	12V	-	-	-	9V	-	-	-	-	-	1	1	OFF	OFF	OFF	OFF	2	1	2	2	2	1	9V	41	80	90	100	deg.
V32	Pin ② voltage	32	-	0V	0V	12V	-	-	-	9V	-	-	-	-	-	1	1	OFF	OFF	OFF	OFF	2	1	2	2	2	1	9V		4.1	4.5	4.9	V
V34	Pin ④ voltage	34	-	0V	0V	12V	-	-	-	9V	-	-	-	-	-	1	1	ON	ON	ON	ON	2	1	2	2	2	1	9V		-4.5	4.5	4.9	V

*: "-" indicates OPEN.

NTSC VIDEO CHROMA DEFLECTION

DEFLECTION SECTION (cont.)

Symbol	Parameter	Test point	Input (B)	Test conditions*																Limits			Unit			
				1	5	7	8	10	14	S	S	S	S	S	S	S	S	S	S	36	Min.	Typ.		Max.		
T _{BGP1}	Burst gate pulse timing - 1	1	SG9	9V	-	12V	9V	-	-	ON	ON	1	ON	ON	ON	ON	ON	ON	1	1	9V	74	0.4	0.7	1.0	μS
T _{BGP2}	Burst gate pulse timing - 2	1	SG9	9V	-	12V	9V	-	-	ON	ON	1	ON	ON	ON	ON	ON	ON	1	1	9V	75	1.0	1.4	1.8	μS
V _{FBP}	FBP clamp voltage	1	SG9	9V	-	12V	9V	-	-	ON	ON	1	ON	ON	ON	ON	ON	ON	1	1	9V	76	3.6	4.1	4.6	V _{o-p}
V _{BGP}	Burst gate pulse voltage	1	SG9	9V	-	12V	9V	-	-	ON	ON	1	ON	ON	ON	ON	ON	ON	1	1	9V	77	7.5	8.0	8.5	V _{o-p}
V _{THAFC}	AFC detector voltage	1	SG9	9V	-	12V	Variable	-	-	ON	ON	1	ON	ON	ON	ON	ON	ON	1	1	9V	78	-	0.4	1.0	V
V _{Vmax}	Vertical output maximum voltage	1	SG9	9V	5V	12V	9V	-	-	ON	ON	3	ON	ON	ON	ON	ON	ON	1	1	9V	79	4.0	4.7	5.4	V _{o-p}
ISSH	Sync separation input sensitivity current (horizontal)	51	-	9V	5V	12V	9V	-	-	ON	ON	1	ON	ON	ON	ON	ON	ON	3	2	9V	80	10	40	100	μA
ISSV	Sync separation input sensitivity current (vertical)	51	-	9V	5V	12V	9V	-	-	ON	ON	1	ON	ON	ON	ON	ON	ON	3	2	9V	81	10	40	100	μA
V _{14P}	Overvoltage protector circuit operating voltage	14, 23, 13,6	-	9V	5V	12V	9V	-	Variable	ON	ON	2	ON	ON	ON	ON	ON	OFF	3	3	9V	82	0.4	0.7	1.0	V
V _{32P1}	Supply voltage detector circuit operating characteristics - 1	36A, 23, 13,6	-	32A	-	12V	32A	-	-	ON	ON	2	ON	ON	ON	ON	ON	ON	3	3	Variable	83	11.3	11.65	12.0	V
V _{32P2}	Supply voltage detector circuit operating characteristics - 2	36A, 6	-	32A	-	12V	32A	-	-	ON	ON	2	ON	ON	ON	ON	ON	ON	3	3	Variable	84	1.5	2.0	2.5	V

*: "-" indicates OPEN.

ELECTRICAL CHARACTERISTICS TEST METHOD

Note 1. Video Maximum Output "Y_{max}"

- a. Make SG1 input level +20dB.
- b. Test amplitude of ⊗ when not blanking.

Note 2. Video Standard Gain "GY"

- a. Test amplitude of ⊗ when not blanking and make VCO the testing value.

b. $G_y = 20 \log \frac{V_{co} (mV_{p-p})}{200 (mV_{p-p})} (dB)$

Note 3. Video Gain Variation Characteristics-1 "GY_{mid}"

Note 4. Video Gain Variation Characteristics-2 "GY_{min}"

Note 5. Video Gain Variation Characteristics-3 "GY_{max}"

- a. Make V_{c1}, V_{c2}, and V_{c3} the output amplitude of ⊗ when 37A is 4.5V, 0V, and 9V.

b. $G_{Ymid} = 20 \log \frac{V_{c1}}{V_{c0}} (dB)$, $G_{Ymin} = \log \frac{V_{c2}}{V_{c0}} (dB)$

$G_{Ymax} = 20 \log \frac{V_{c3}}{V_{c0}} (dB)$

Note 6. Brightness Variation Characteristics-1 "Y_{BRTmid}"

Note 7. Brightness Variation Characteristics-2 "Y_{BRTmin}"

Note 8. Brightness Variation Characteristics-3 "Y_{BRTmax}"

- a. Test DC voltage of ⊗ when not blanking.

Note 9. Video Output Minimum Voltage "YL"

- a. Test DC voltage of ⊗ when not blanking.

Note 10. Black Level Correction Variation Characteristics-1 "Y_{BLC1}"

Note 11. Black Level Correction Variation Characteristics-2 "Y_{BLC2}"

- a. Test DC voltage of ⊗ when not blanking.

Note 12. Video Differential Gain Characteristics "DG"

- a. Make V_{G1} and V_{G2} the output amplitude of ⊗ when ⊗ is 2.5V and 2.3V.

b. $DG = \frac{V_{G1} - V_{G2}}{V_{G2}} \times 100 (\%)$

Note 13. Video High-Pass Standard Gain "GYHI"

Test the amplitude of ㊦ when not blanking and make V_{Hi} the testing value.

$$b. GYHI = 20 \log \frac{V_{HI}(mV_{P-P})}{200(mV_{P-P})} \text{ (dB)}$$

Note 14. Video Tone Characteristics-1 "GTmid"

Note 15. Video Tone Characteristics-2 "GTmin"

Note 16. Video Tone Characteristics-3 "GTmax"

a. Make V_{T0}, V_{T1}, V_{T2}, and V_{T3} the output amplitude of ㊦ when 46A is changed to open, 4.5V, 9V, and 0V.

$$b. GTmid = 20 \log \frac{V_{T1}}{V_{T0}} \text{ (dB)}$$

$$GTmin = 20 \log \frac{V_{T2}}{V_{T0}} \text{ (dB)}$$

$$GTmax = 20 \log \frac{V_{T3}}{V_{T0}} \text{ (dB)}$$

Note 17. Video Frequency Characteristics "Gr"

a. Input SG4 and change the frequency. Make SG4 input frequency the frequency when ㊦ output amplitude is -3dB less than when SG1 was being input.

Note 18. Horizontal Blanking Operation Voltage "Y_{HBLK}"

a. Make voltage of 1A the voltage where horizontal blanking for ㊦ ceases as the voltage of 1A is gradually dropped below 9V.

Note 19. Vertical Blanking Voltage "Y_{VBLK}"

a. Test DC voltage during vertical blanking of ㊦.

Note 20. DC Playback Ratio Correction Variation Characteristics "Y_{DREG}"

a. Test DC voltage variance when ㊦ is not blanking and switch 38 is turned from ON to OFF.

Note 21. Video Peak Limiter Variation Characteristics-1 "Y_{PLmid}"

Note 22. Video Peak Limiter Variation Characteristics-2 "Y_{PLmax}"

a. Test DC voltage of ㊦ when not blanking.

Note 23. V Blanking Amplitude "T_{BLKV}"

a. Test DC voltage during vertical blanking of ㊦.

Note 24. Black Level Replacement Threshold Voltage "Y_{BTH}"

a. Gradually increase voltage of ㊦ from 2.5V.
b. Make Y_{BTH} the voltage of ㊦ when blanking of ㊦ is replaced by black level voltage.

Note 25. ACC Characteristics-1 "ACC1"

Note 26. ACC Characteristics-2 "ACC2"

a. Make V_{A0}, V_{A1}, and V_{A2} the demodulated output amplitude of 27A when SG5 input level is 0dB, -18dB, +6dB.

$$b. ACC1 = 20 \log \frac{V_{A1}}{V_{A0}} \text{ (dB)}$$

$$ACC2 = 20 \log \frac{V_{A2}}{V_{A0}} \text{ (dB)}$$

Note 27. Color Control Variation Characteristics-1 "C_{cmid}"

Note 28. Color Control Variation Characteristics-2 "C_{cmin}"

Note 29. Color Control Variation Characteristics-3 "C_{cmax}"

a. Make V_{c10}, V_{c11}, V_{c12}, and V_{c13} the demodulated output amplitude of 27 when 34A is open, 4.5V, 0V, and 9V.

$$b. Ccmid = 20 \log \frac{V_{c11}}{V_{c10}} \text{ (dB)}$$

$$Ccmin = 20 \log \frac{V_{c12}}{V_{c10}} \text{ (dB)}$$

$$Ccmmax = 20 \log \frac{V_{c13}}{V_{c10}} \text{ (dB)}$$

Note 30. Color Tracking Variation Characteristics-1 "C_{umid}"

Note 31. Color Tracking Variation Characteristics-2 "C_{umin}"

Note 32. Color Tracking Variation Characteristics-3 "C_{umax}"

a. Make V_{u0}, V_{u1}, V_{u2}, and V_{u3} the demodulated output amplitude of 27A when 41A is open, 4.5V, 0V, and 9V.

NTSC VIDEO CHROMA DEFLECTION

$$b. \text{Cumid} = 20 \log \frac{V_{u1}}{V_{u0}} \text{ (dB)}$$

$$\text{Cumin} = 20 \log \frac{V_{u2}}{V_{u0}} \text{ (dB)}$$

$$\text{Cumax} = 20 \log \frac{V_{u3}}{V_{u0}} \text{ (dB)}$$

Note 33. APC Pull-in Range-1 "fpc1"

Note 34. APC Pull-in Range-2 "fpc2"

- a. Frequency range where the 27A output signal changes from off to on as the burst and chroma frequency ($f_{sb}=f_{sc}$) are altered during SG7 input. The standard value is 3.579545MHz.

Note 35. Killer Operating Level "KIL"

- a. SG6 input level where the ⑳ output signal changes from off on as SG6 input level is gradually decreased.

Note 36. Killer Color Residual "DKL"

- a. ㉑ output signal amplitude when $e_b=0\text{mV}_{P-P}$, $e_c=100\text{mV}_{P-P}$, and frequency $f_{sc}=3.579545\text{MHz}$ during SG6 input.

Note 37. Demodulated Output Carrier Leak "Cleak"

- a. Test carrier element output by 17, 19, and 21.

Note 38. Tint Control Varlance "T"

- a. Using an oscilloscope (X-Y display), test the variation of amplitude phase of the ⑳ and ㉑ output signals when 28A is 0V and 9V.

Note 39. Tint Control Characteristics-1 "Tmin"

Note 40. Tint Control Characteristics-2 "Tmax"

- a. Using an oscilloscope (X-Y display), test the variation of amplitude phase of the ⑳ and ㉑ output signals when 28A is 4.5V, 0V, and 9V. Use the phase at 4.5V as reference.

Note 41. Demodulated Phase Angle-1 " θ_{IR} "

- a. Make θ_{IR} the phase angle of 27A and 28A.

Note 42. Color Signal Suppression Characteristics "CS"

- a. Input APL 10% SG14 from B, and make V_{cs1} the demodulated output amplitude of 27A.
b. Input APL 35% SG14 from B, and make V_{cs1} the demodulated output amplitude of 27A.

$$c. \text{CS} = 20 \log \frac{V_{cs1}}{V_{cs2}} \text{ (dB)}$$

Note 43. Matrix Gain I-R "MIR"

Note 44. Matrix Gain I-R "MIR"

Note 45. Matrix Gain I-G "MIG"

Note 46. Matrix Gain I-B "MIB"

Note 47. Matrix Gain Q-R "MQR"

Note 48. Matrix Gain Q-G "MQG"

Note 49. Matrix Gain Q-B "MQB"

1. Input SG16 from E and test the output amplitude of ⑰, ⑱, and ㉑.

Note 50. On-screen Characteristics-1 "OS1"

- a. With pins ㉑ and ㉒ at 0V, test the output voltage of pin ⑰ when 0V and 3V are applied to pin ⑱ and make OS1 the difference in electric potentials.

Note 51. On-screen Characteristics-2 "OS2"

- a. With pins ⑱ and ㉒ at 0V, test the output voltage of pin ⑰ when 0V and 3V are applied to pin ㉑ and make OS2 the difference in electric potentials.

Note 52. On-screen Characteristics-3 "OS3"

- a. With pins ⑱ and ㉑ at 0V, test the output voltage of pin ⑰ when 0V and 3V are applied to pin ㉒ and make OS3 the difference in electric potentials.

Note 53. Pin ㉑ "V₂₅"

Note 54. Pin ㉒ "V₂₆"

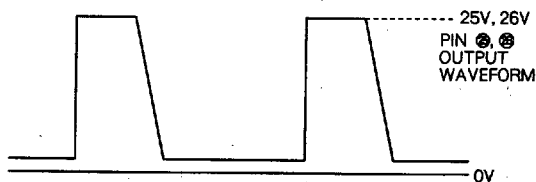

Note 55. Demodulated Typical Output-1 "Qnorm"

Note 56. Demodulated Typical Output-2 "Inorm"

- a. With conditional input (A), test output amplitude of 27A and 28A when SG5 is input and 34A and 41A are open.

Note 57. Demodulated Maximum Output-1 "Qmax"

NTSC VIDEO CHROMA DEFLECTION

Note 58. Demodulated Maximum Output-2 "Imax"

- a. With conditional input (A), test output amplitude of 27A and 28A when color contrast is maximum and 9V is applied to 34A and 41A respectively.

Note 59. Chroma Maximum Output-1 "Rmax"

Note 60. Chroma Maximum Output-2 "Gmax"

Note 61. Chroma Maximum Output-3 "Bmax"

Note 62. Chroma Maximum Output-4 "Rmax"

- a. Apply 9V to 34A and 41A respectively and test output amplitude of chroma difference output of ⑰, ⑱, and ㉑ while SG5 is input at maximum color contrast.

Note 63. Horizontal/Vertical Sync Output Amplitude "Voshv"

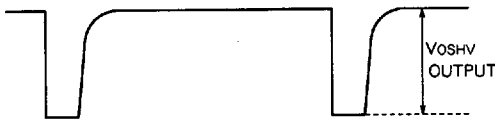

Note 64. Oscillator Frequency Temperature Coefficient "fi/Ts"

- a. Make -20~+65°C the temperature variation range.

Note 65. Oscillator Starting Pin ⑦ Voltage "V7min"

- a. Gradually increase the applied voltage of 7A.
- b. V7min is the voltage of ⑦ when the cycle of ⑲ output waveform becomes approx. 63.5µs.

Note 66. Pull-in Range-1 "fPH-1"

- a. Gradually increase the SG11 input signal frequency so that the input signal and ⑬ output become unsynchronized.
- b. Decreasing the input signal frequency, make this the difference between the input signal frequency and oscillator frequency (fiH) precisely when the input signal and ⑬ output become synchronized.
- c. Perform the same procedure for the lower side pull-in range.

Note 67. H. Pulse Amplitude "τH"

Note 68. H. Output Voltage "VHmin VHmax"

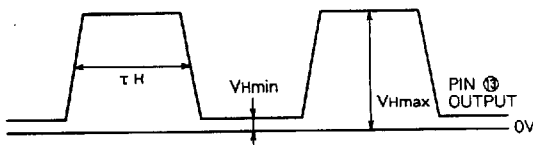

Note 69. V.Pulse Amplitude-1 "τ v1"

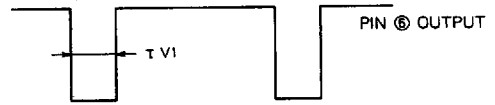

Note 70. Pull-in Range "fPV"

- a. Gradually increase the SG12 input signal frequency so that the input signal and ⑥ output become unsynchronized.
- b. Decreasing the input signal frequency, make this the input signal frequency precisely when the input signal and ⑥ output become synchronized.

Note 71. Ramp Maximum Output Voltage "VOH4"

Note 72. Ramp Minimum Output Voltage "VOL4"

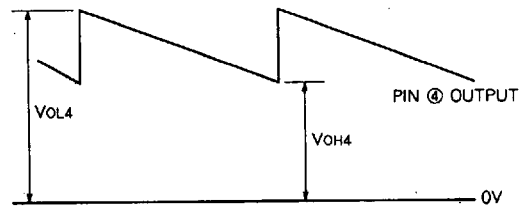

Note 73. Burst Gate Pulse Position "TGP"

Note 74. Burst Gate Pulse Timing-1 "TBGP1"

Note 75. Burst Gate Pulse Timing-2 "TBGP2"

Note 76. FBP Clamp Voltage "VFBP"

Note 77. Burst Gate Pulse Voltage "VBGP"

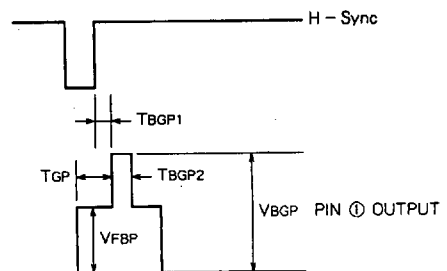

Note 78. AFC Detector Voltage "VTHAFC"

- a. Set voltage of 8A to 9V.
- b. Make VTHAFC the applied voltage of 8A precisely when AFC begins to behave abnormally as voltage of 8A is gradually increased.

NTSC VIDEO CHROMA DEFLECTION

Note 79. Vertical Output Maximum Voltage "V_{max}"

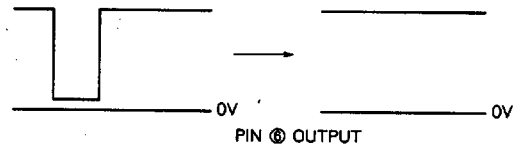
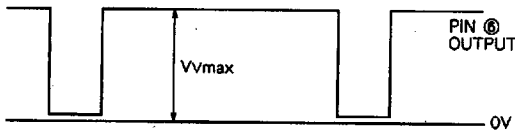

Note 80. Sync Separation Input Sensitivity Current (Horizontal) "I_{SSH}"

- Set I_{S1} to 0mA.
- Make I_{SSH} the value of I_{S1} when the voltage of ⑤ is in the area of 3V as I_{S1} is gradually increased.

Precautions Concerning Electrical Characteristics

- Adjust the one-shot multivibrator's potentiometer so that the timing of the horizontal input flyback pulse for pins ①, ③ and pulse amplitude are as shown in the figure below.

Note 81. Sync Separation Input Sensitivity Current (Vertical) "I_{SSV}"

- Same as Note 80.

Note 82. Overvoltage Protector Circuit Operating Voltage "V_{14P}"

- Set voltage of ⑭ to 0V.
- As voltage of ⑭ is gradually increased, (??) begins blanking and output waveform of ⑬ ceases. Make V_{14P} the applied voltage of ⑭ when output waveform of ⑬ ceases.

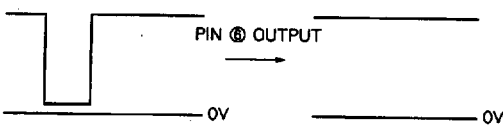
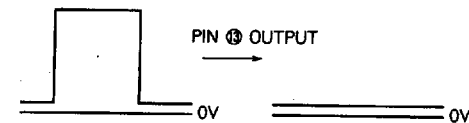
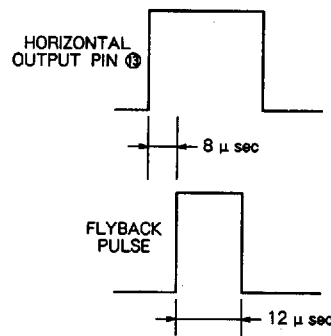

- In order to perform the following test, first turn off all applied voltages.

2. Standard Conditions of Deflection Section for Testing Video/Chroma Sections

Input C	5	7	8	10	14	S	S	S	S	S	S	S	S	S	S	S	S
	A	A	A			1	4	5	6	8	9	10	13	14	49	50	
SG9	-	12V	9V	-	-	ON	ON	1	OFF	ON	ON	ON	ON	ON	1	1	

"-" indicates OPEN.

3. Standard Conditions of Video/Chroma Sections for Testing Deflection Section

Input A,B,D	18	20	22	32	34	35	37	39	40	41	42	46	S	S	S	S	S	S	SD
				A	A			A		A		A	31	38	40	42	43	45	47
	0	0	0	-	-	-	-	-	-	-	-	-	OFF	OFF	2	1	2	2	2
	V	V	V																

"-" indicates OPEN.

Note 83. Supply Voltage Detector Circuit Operating Voltage-1 "V_{32P1}"

- Set voltage of 36A to 9V.
- Gradually increase voltage of 36A and make V_{32P1} the applied voltage of 36A when status becomes as described in step ② of Note 83.
- In order to perform the following test, first turn off all applied voltages.

Note 84. Supply Voltage Detector Circuit Operating Voltage-2 "V_{32P2}"

- Set voltage of 36A to 9V.
- As voltage of 36A is gradually decreased, 6 output ceases. Make V_{32P2} the applied voltage of 32A when DC voltage becomes approx. 1.3V.

M52023SP

NTSC VIDEO CHROMA DEFLECTION

INPUT SIGNAL

SG No.	Signal name	Signals
SG1	200kHz sine wave	Establish 0dB as 200mV _{P-P} .
SG2	APL100% standard signal	
SG3	2MHz sine wave	Establish 0dB as 100mV _{P-P} .
SG4	Sine wave	Sine wave with variable frequency where 0dB is set to 200mV _{P-P} .
SG5	Chroma standard signal (color bar)	<p> fsb: Burst signal frequency fsc: Chroma signal frequency fsb = fsc = 3.579545MHz 0dB: eb = 50mV_{P-P} eb = 100mV_{P-P} </p>
SG6	Chroma signal - 1	<p> fsb = fsc = 3.579545MHz (same phase) 0dB: eb = 50mV_{P-P} eb = 100mV_{P-P} </p>
SG7	Chroma signal - 2	Chroma signal with variable frequency where all burst and chroma signals are the same phase with respect to chroma signal 1 of SG6.
SG8	Chroma signal - 3	Chroma signal where fsb = 3.579545MHz, fsc = 5.529545MHz (fsb - 50kHz) with respect to chroma signal 1 of SG6.
SG9	Standard sync signal	
SG10	APL 50% standard signal	
SG11	Sync signal - 1	

SG No.	Signal name	Signals
SG12	Sync signal - 2	
SG13	5MHz sine wave	Establish 0dB as 100mV _{P-P} .
SG14	Variable APL standard signal	Variable(0.357V _{P-P} should be APL100%.)
SG16	1kHz sine wave	Burst should be 0mV _{P-P} , chroma frequency should be 100kHz, and amplitude should be 500mV _{P-P} in relation to chroma signal 1 of SG6.

TYPICAL CHARACTERISTICS

