

M52065P/FP**3-CHANNEL ANALOG SWITCH****DESCRIPTION**

The M52065 is an analog switch semiconductor integrated circuit designed for VCR and audio equipment applications. This IC contains three channels of 2-input switches. Each can be controlled independently.

FEATURES

- Small output voltage difference.....5 mV max. typ.
- Capable of DC direct connection because of no difference in DC voltage between input and output
- Low switching noise
- Wide dynamic range
- Wide frequency range.....30 MHz min. typ.
- Excellent crosstalk characteristic

APPLICATION

VCR, Audio equipment

RECOMMENDED OPERATING CONDITION

Supply voltage range.....4.5-7V

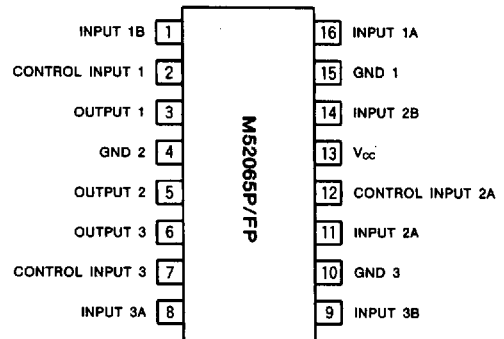
PIN CONFIGURATION (TOP VIEW)

Outline 16P4(P)
16P2P-A(FP)

www.DataSheet4U.com

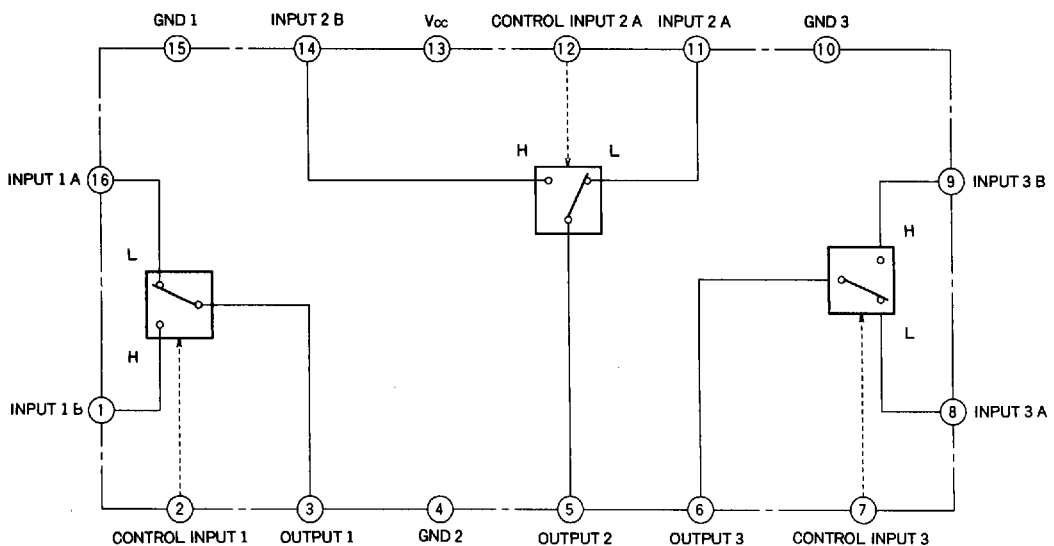
BLOCK DIAGRAM

3-CHANNEL ANALOG SWITCH

ABSOLUTE MAXIMUM RATINGS

Symbol	Parameter	Ratings	Unit
V _{cc}	Supply voltage	14	V
P _d	Power dissipation	1000 (430)	mW
K _θ	Thermal derating	10 (4.3)	mW/°C
T _{opr}	Operating temperature	-20~75	°C
T _{stg}	Storage temperature	-40~125	°C

Note : Figures given in () apply to FP.

ELECTRICAL CHARACTERISTICS (T_a=25°C, unless otherwise noted)

Symbol	Parameter	Test conditions	Limits			Unit
			Min.	Typ.	Max.	
I _{cc}	Circuit current	When V _{cc} =5V	6.2	8.8	11.4	mA
G _{v1}	Voltage gain 1	f=1MHz, V _{in} =0.5V _{p-p}	-0.7	-0.2	0.3	dB
G _{v2}	Voltage gain 2	f=10MHz, V _{in} =0.5V _{p-p}	-0.6	-0.1	0.4	dB
HD	Second high harmonic distortion	f=5MHz, V _{in} =2.0V _{p-p}		-55	-50	dB
CT _{sw}	Switch crosstalk	f=5MHz, V _{in} =0.5V _{p-p}		-70	-60	dB
CT _{ch}	C to H crosstalk	f=5MHz, V _{in} =0.5V _{p-p}		-70	-60	dB
V _{os}	DC output offset voltage		-10	0	10	mV
V _{io}	Input to output offset voltage		0	50	80	mV
V _{th}	SW threshold voltage	When V _{cc} =5V	1.5		2.0	V
Z _{in}	Input impedance					

TYPICAL CHARACTERISTICS

THERMAL DERATING (MAXIMUM RATING)

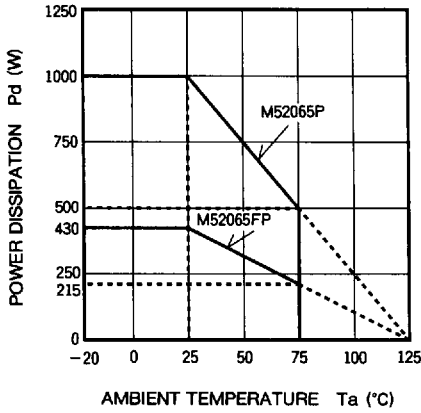

M52065P FREQUENCY CHARACTERISTICS

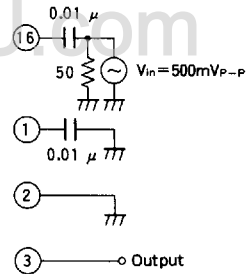
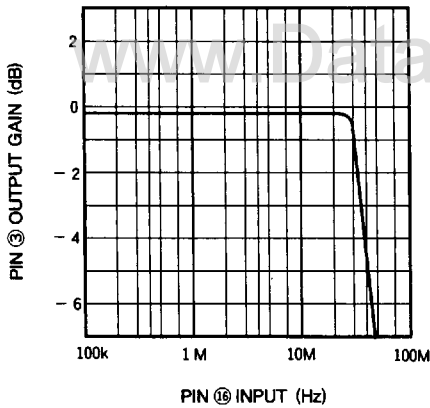

M52065P INPUT/OUTPUT CHARACTERISTICS

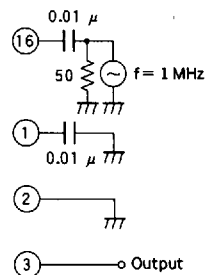
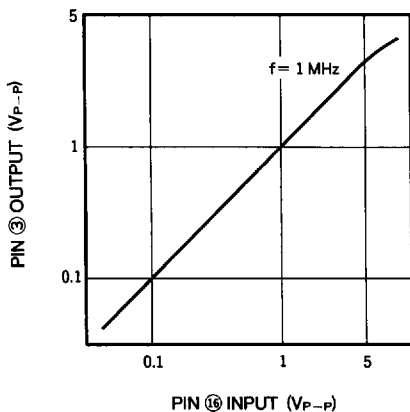

3-CHANNEL ANALOG SWITCH

M52065P DC INPUT/OUTPUT CHARACTERISTICS

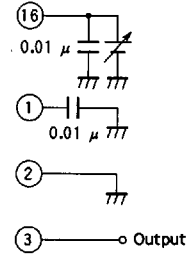
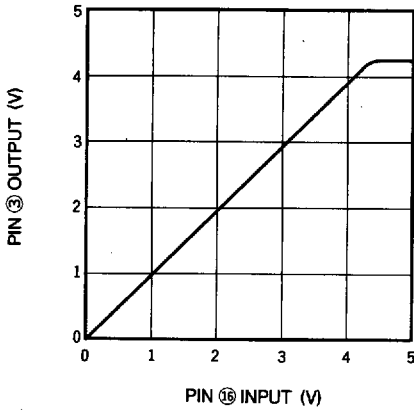

M52065P SECOND AND THIRD DISTORTION f=5 MHz

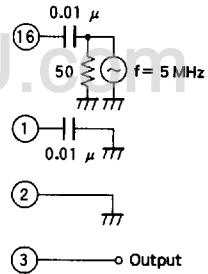
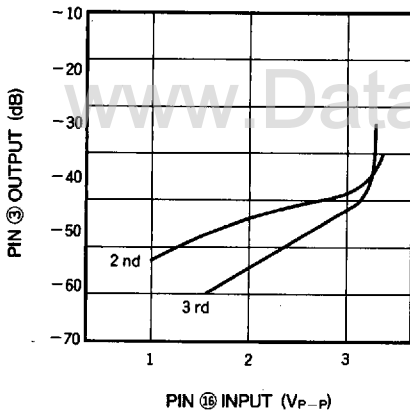

M52065P CROSSTALK CHARACTERISTICS

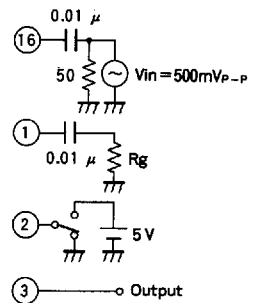
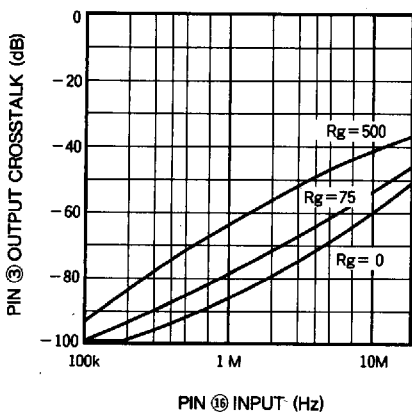

3-CHANNEL ANALOG SWITCH

APPLICATION EXAMPLE

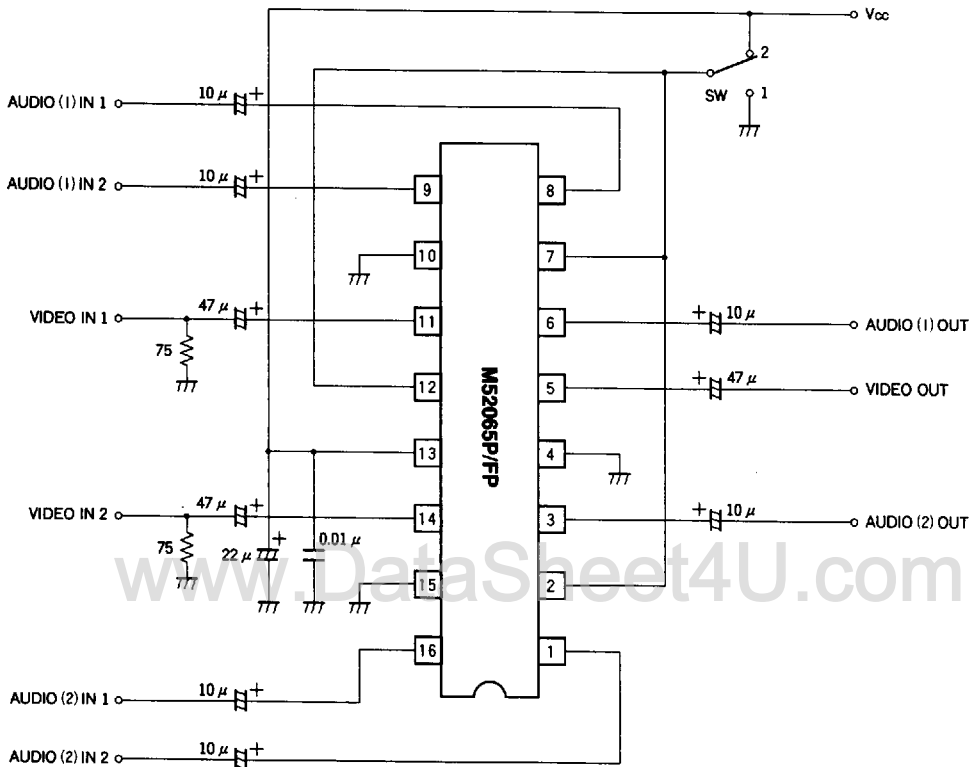

Unit Resistance : Ω
Capacitance : F

3-CHANNEL ANALOG SWITCH

DESCRIPTION OF PIN (The voltage and current values indicated below apply when $V_{CC}=5V$)

Pin No.	Name	Function		DC Voltage (V)
① ⑧ ⑨ ⑪ ⑭ ⑯	Input	Signal input pin		2.0
③ ⑤ ⑥	Output	Signal output pin		1.95
② ⑦ ⑫	SW	Switching pulse input pin		—