



ONE KEY MULTI-SECTION
14 SEC VOICE

14 秒 語 音 IC

VOICE	
M5214	

FEATURES 功能敘述

- IO1 : D/A, BusyH, BusyL, StopH, StopL, 3 Hz, 6 Hz, dynamic.
- IO2 : PWM1, BusyH, BusyL, StopH, StopL, 3 Hz, 6 Hz, dynamic.
- IO3 : PWM2, BusyH, BusyL, StopH, StopL, 3 Hz, 6 Hz, dynamic.
- Up to 16 voice section.
- 112 voice steps table up to 16 sub-table of steps.
- Direct driver speaker or buzzer.
- External or Built-in resistor.
- TG : SEQUENTIAL/RANDOM TRIGGER, EDGE/LH, RETRIG/IRRETRIG, HOLD/UNHOLD.
- Debounce time : 10ms/50 μ s
- Voice + Mute length MAX. 22 sec (S.R=6KHz)

APPLICATION 產品應用

- Toy s, Clock, Pager, Game etc..

ELECTRICAL CHARACTERISTICS 電氣規格

(@V_{DD}=3V unless otherwise specified)

Characteristics	Sym.	Min.	Typ.	Max.	Unit	REMARKS
工作電壓 Operating Voltage	V _{DD}	2.4	3	5.0	V	
工作電流 Operating Current	I _{OP}	—	0.2	1	mA	No load
靜態電流 Quiescent Current	I _{SB}	—	1	5	μ A	
推動電流 AUD Driving Current	I _O	—	-3	—	mA	@ Vout=0.7V, Full Scale
推動電流 LO Driving Current	I _{OH}	1	—	—	mA	@ Vout=2V
	I _{OL}	3	—	—		@ Vout=1.0V
振盪頻率 Oscillator Frequency	F _{OSC}	—	768	—	KHz	External \pm 30%, Rosc=K Ω
工作溫度 Operating Temperature	Temp.	-10	25	60	$^{\circ}$ C	

APPLICATION DIAGRAM 參考電路圖

(A) IO1-LED IO2:PWM1 IO2:PWM2

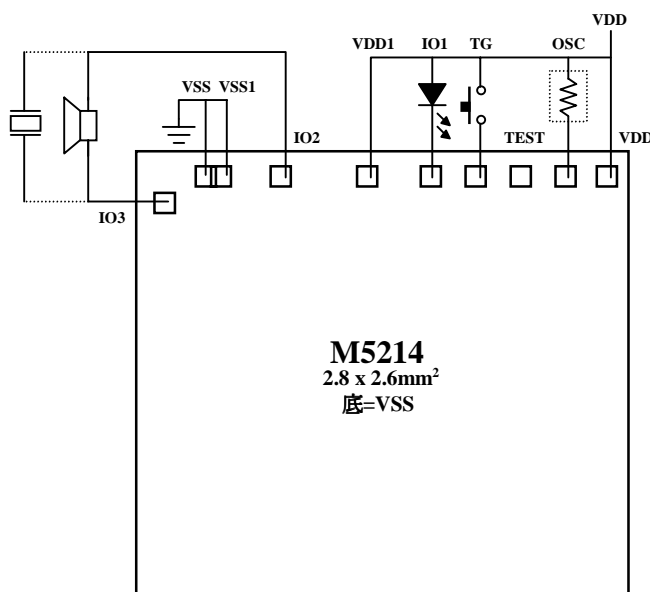

*All specs and applications shown above subject to change without prior notice.

(以上電路及規格僅供參考,本公司得逕行修正)



一 華 半 導 體 有 限 公 司
MOSDESIGN SEMICONDUCTOR CORP.

“TENTATIVE”

TAIPEI : TEL : 886-2- 22783733

FAX : 886-2- 22783633

H.K. : TEL : 852- 27569109

FAX : 852- 27566961

ONE KEY MULTI-SECTION
14 SEC VOICE

14 秒 語 音 IC

VOICE	
M5214	

APPLICATION DIAGRAM 參考電路圖 (CONTINUED)

(B) IO1-D/A IO2:PWM1 IO2:PWM2

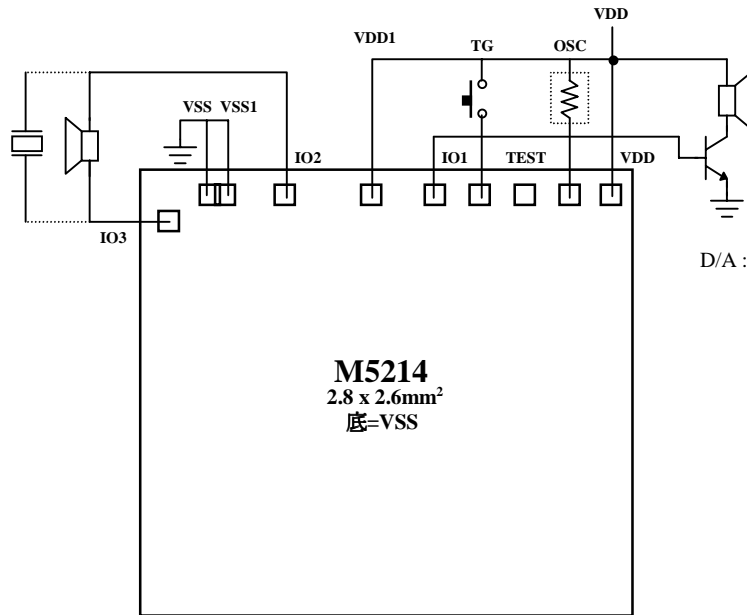

D/A : 3 current output level
(1.5mA, 3mA, 4.5mA)
By mask option

*All specs and applications shown above subject to change without prior notice.
(以上電路及規格僅供參考,本公司得逕行修正)



ONE KEY MULTI-SECTION
14 SEC VOICE

14 秒語音 IC

VOICE	
M5214	

SEQUENTIAL TRIGGER:

• EDGE/UNHOLD

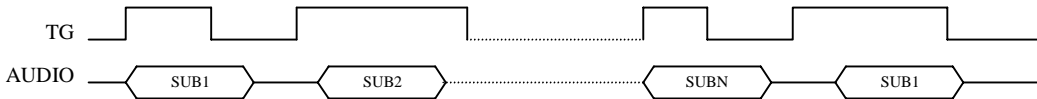

• LH/UNHOLD

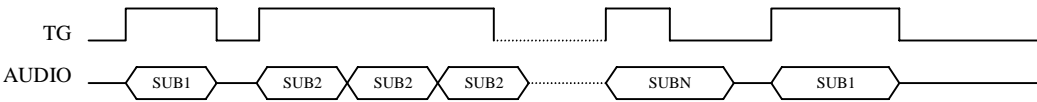

• EDGE/HOLD

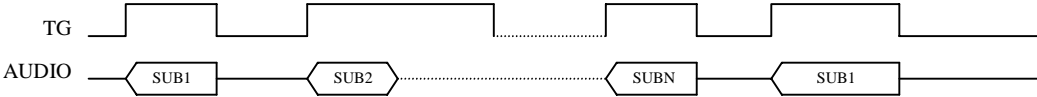

• LH/HOLD

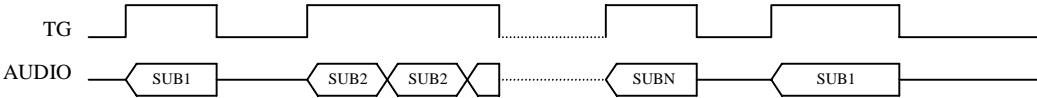

• RETRIG

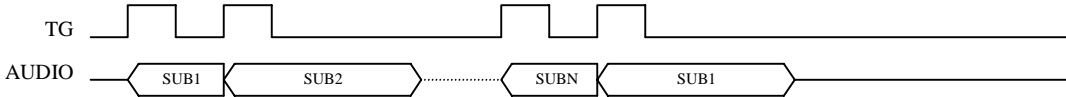

• IRRETRIG

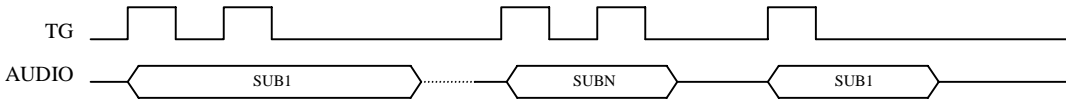



ONE KEY MULTI-SECTION
14 SEC VOICE

14 秒語音 IC

VOICE	
M5214	

RANDOM TRIGGER:

• EDGE/UNHOLD

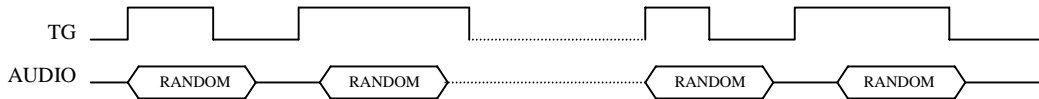

• LH/UNHOLD

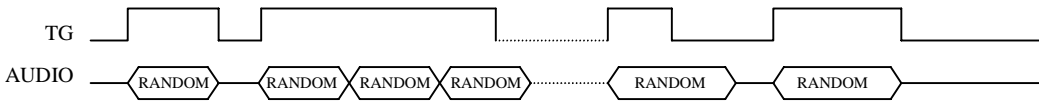

• EDGE/HOLD

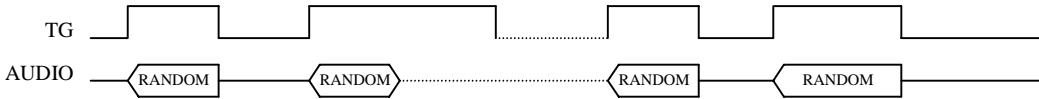

• LH/HOLD

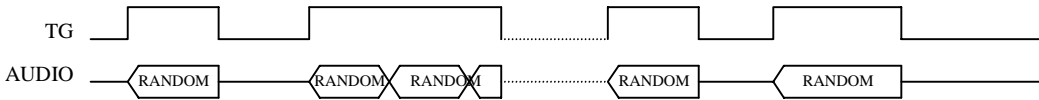

• RETRIG

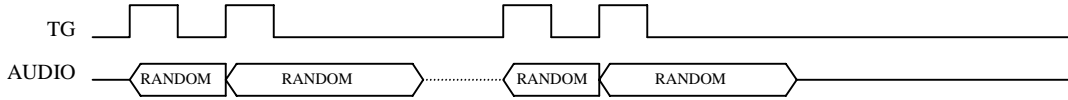

• IRRETRIG

