

M5216L/P/FP

DUAL LARGE-CURRENT OPERATIONAL AMPLIFIERS (DUAL POWER SUPPLY TYPE)

DESCRIPTION

The M5216 is a semiconductor integrated circuit designed as a high-output and high-speed operational amplifier for use in high-performance headphone amplifiers and mixer amplifiers found in cassette decks.

The device comes in an 8-pin SIP, DIP or FP and it contains two circuits for yielding a high internally phase-compensated gain, a high current capacity and a high slew rate. It can be widely used as a general-purpose dual amplifier in electronic equipment. In addition, it can be used in a single power supply format and employed in conditions where the supply voltage is low. These are features which make this device ideal for headphone amplifiers in portable products.

FEATURES

- Large current capacity $I_{LP} = \pm 100\text{mA}$
- High power output
 $P_O = 40\text{mW}(\text{typ.}) @ V_{CC} = 6\text{V}, R_L = 32\Omega$
 $P_O = 27\text{mW}(\text{typ.}) @ V_{CC} = 20\text{V}(\pm 10\text{V})$
 $R_O + R_L = 100\Omega + 8\Omega$
- High slew rate, high f_T $SR = 3.0\text{V}/\mu\text{s}, f_T = 10\text{MHz}(\text{typ.})$
- Low noise ($R_S = 1\text{k}\Omega$) FLAT $V_{NI} = 1.8\mu\text{Vrms}(\text{typ.})$
- Low supply voltage drive possible $V_{CC} \geq 4\text{V}(\pm 2\text{V})$
- High allowable power $P_d = 800\text{mW}(\text{SIP})$
 $P_d = 625\text{mW}(\text{DIP}), P_d = 440\text{mW}(\text{FP})$

APPLICATION

High-performance headphone amplifiers in VTRs, tape decks and stereo cassette tape recorders with built-in radios; also as a large current high speed, general-purpose operating amplifier in other electronic products and equipment.

RECOMMENDED OPERATING CONDITION

- Supply voltage range $\pm 2\text{V} \sim \pm 16\text{V}$ (dual power supply)
 $\pm 4\text{V} \sim \pm 32\text{V}$ (single power supply)
- Rated supply voltage $\pm 15\text{V}$

PIN CONFIGURATION (TOP VIEW)

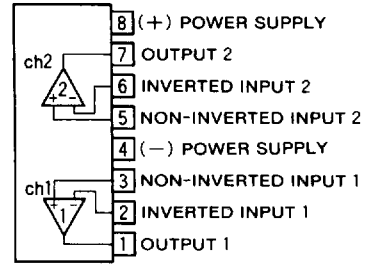

Outline 8P5 (L)

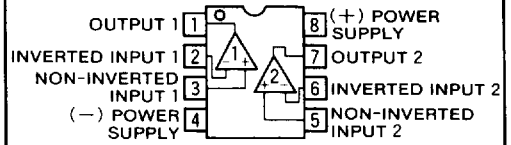

Outline 8P4 (P)
8P2S-A (FP)

BLOCK DIAGRAM

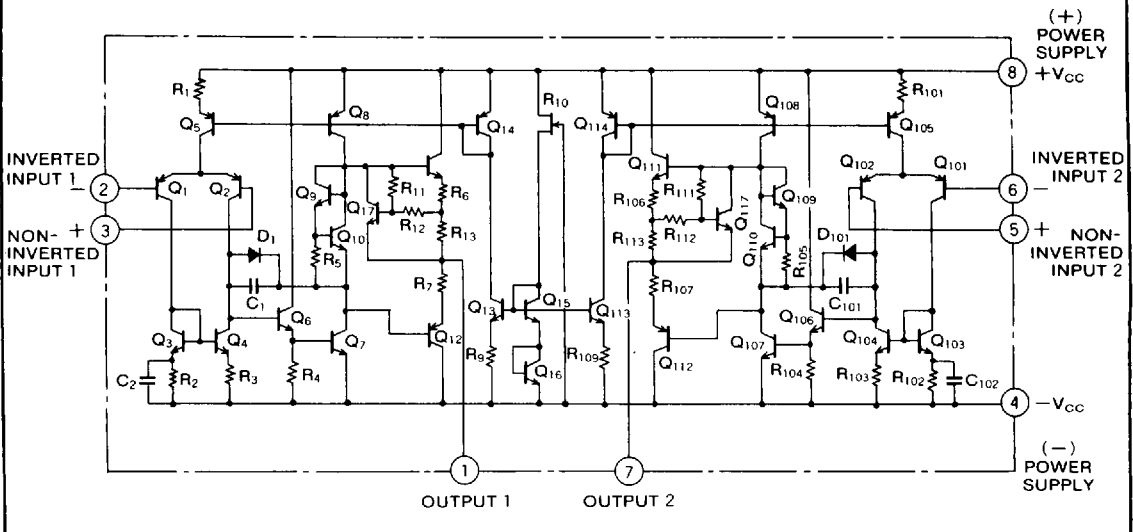

6249826 0021538 T59



DUAL LARGE-CURRENT OPERATIONAL AMPLIFIERS (DUAL POWER SUPPLY TYPE)

ABSOLUTE MAXIMUM RATINGS ($T_a=25^\circ\text{C}$, unless otherwise noted)

Symbol	Parameter	Conditions	Ratings	Unit
V_{CC}	Supply voltage		± 18	V
I_{LP}	Load current		± 100	mA
V_{id}	Differential input voltage		± 30	V
V_{ic}	Common input voltage		± 15	V
P_d	Power dissipation		800(SIP)/625(DIP)/440(FP)	mW
K_θ	Thermal derating	$T_a \geq 25^\circ\text{C}$	8(SIP)/6.25(DIP)/4.4(FP)	mW/°C
T_{opr}	Ambient temperature		$-20 \sim +75$	°C
T_{stg}	Storage temperature		$-55 \sim +125$	°C

ELECTRICAL CHARACTERISTICS ($T_a=25^\circ\text{C}$, $V_{CC}=\pm 15\text{V}$)

Symbol	Parameter	Test conditions	Limits			Unit
			Min.	Typ.	Max.	
I_{CC}	Circuit current	$V_{in}=0$		4.5	9.0	mA
V_{IO}	Input offset voltage	$R_S \leq 10\text{k}\Omega$		0.5	6.0	mV
I_{IO}	Input offset current			5	200	nA
I_{IB}	Input bias current			180	500	nA
R_{in}	Input resistance		0.3	5		MΩ
G_{VO}	Open loop voltage gain	$R_L \geq 2\text{k}\Omega, V_O = \pm 10\text{V}$	86	110		dB
V_{OM}	Maximum output voltage	$R_L \geq 10\text{k}\Omega$ $R_L \geq 2\text{k}\Omega$	± 12 ± 10.5	± 13.5 ± 11		V
V_{CM}	Common input voltage width		± 12	± 14		V
CMRR	Common mode rejection ratio	$R_S \leq 10\text{k}\Omega$	70	90		dB
SVRR	Supply voltage rejection ratio	$R_S \leq 10\text{k}\Omega$		30	150	$\mu\text{V/V}$
P_d	Power dissipation			135	270	mW
SR	Slew rate	$G_v=0\text{dB}, R_L=2\text{k}\Omega$		3.0		V/ μs
f_T	Gain bandwidth product			10		MHz
V_{NI}	Input referred noise voltage	$R_S=1\text{k}\Omega, BW=10\text{Hz} \sim 30\text{kHz}$		1.8		μVrms

TYPICAL CHARACTERISTICS

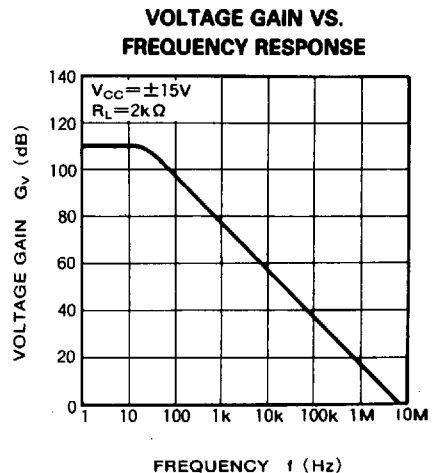
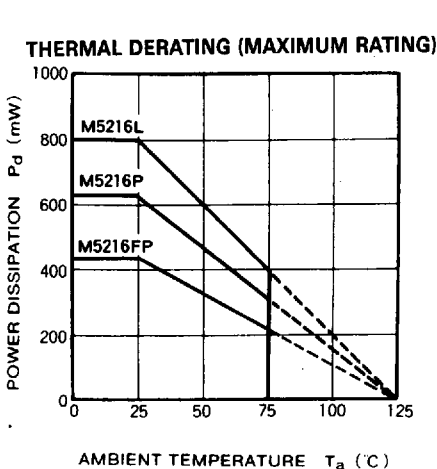

6249826 0021539 995

DUAL LARGE-CURRENT OPERATIONAL AMPLIFIERS (DUAL POWER SUPPLY TYPE)

CIRCUIT CURRENT VS. SUPPLY VOLTAGE

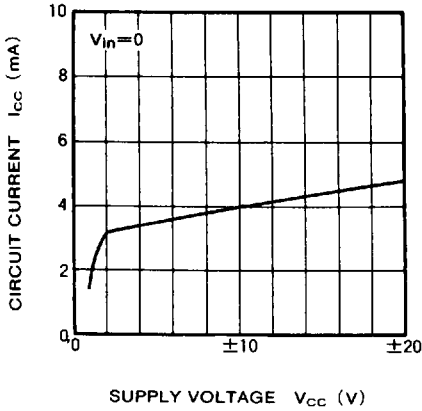

CIRCUIT CURRENT VS. AMBIENT TEMPERATURE

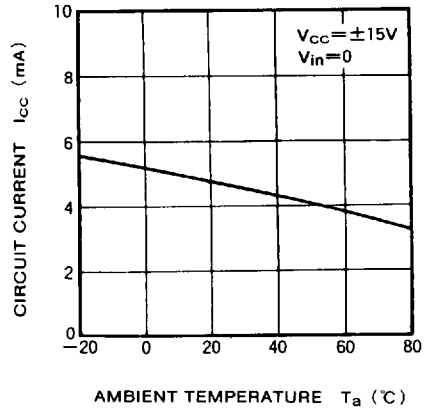

INPUT OFFSET VOLTAGE VS. AMBIENT TEMPERATURE

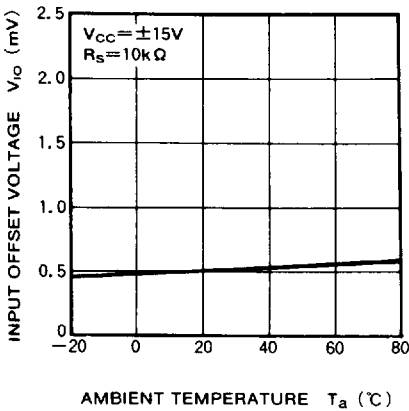

OUTPUT VOLTAGE / LOAD CURRENT PEAK VS. LOAD RESISTANCE

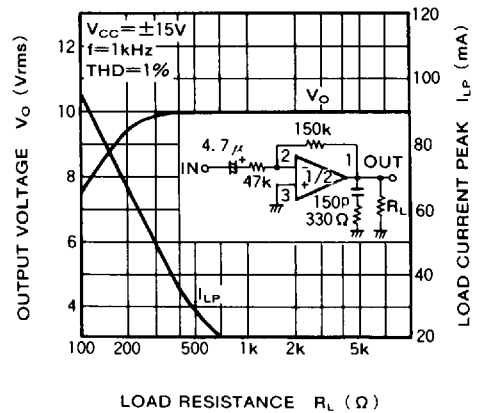

MAXIMUM OUTPUT VOLTAGE VS. SUPPLY VOLTAGE

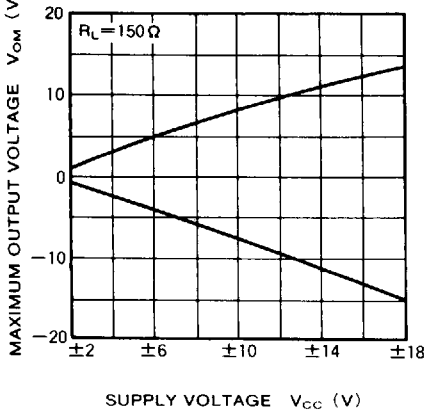

MAXIMUM OUTPUT VOLTAGE VS. FREQUENCY RESPONSE

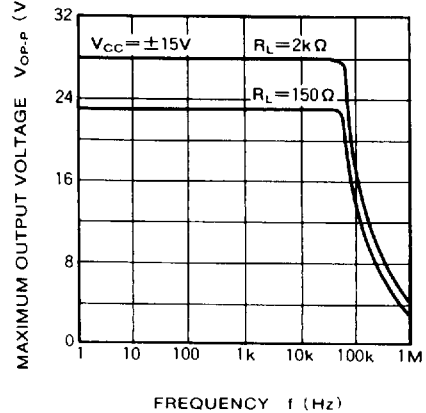

DUAL LARGE-CURRENT OPERATIONAL AMPLIFIERS (DUAL POWER SUPPLY TYPE)

APPLICATION EXAMPLE FOR A HEADPHONE AMPLIFIER (DUAL POWER SUPPLY TYPE)

INVERTED INPUT TYPE

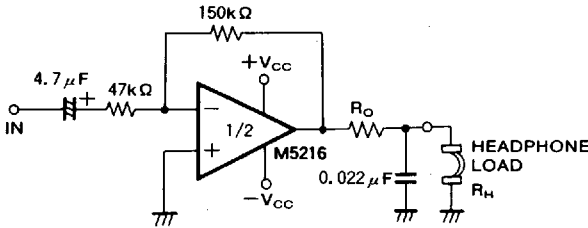

(Note) For a single power supply type, (+) input pin voltage level is shifted at $V_{CC}/2$ and output must be used by AC connection by means of a capacitor.

HEADPHONE AMPLIFIER CIRCUIT $P_o - V_{CC}$ CHARACTERISTICS

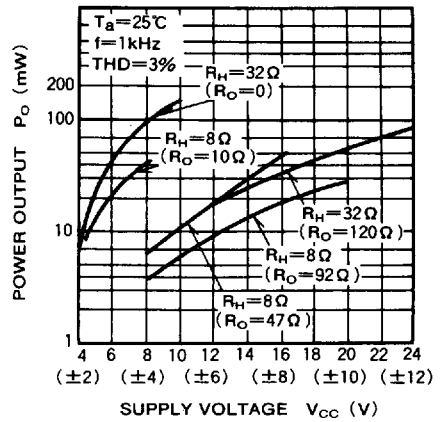

APPLICATION EXAMPLE FOR A HEADPHONE AMPLIFIER (SINGLE POWER SUPPLY TYPE)

NON-INVERTED INPUT TYPE

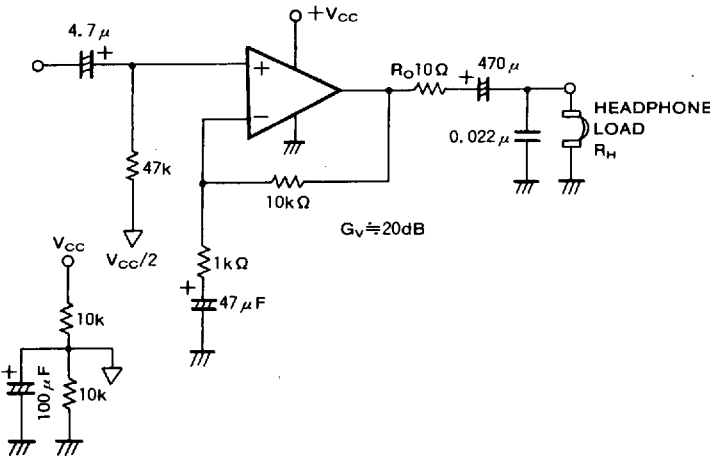

HEADPHONE AMPLIFIER CIRCUIT THD - P_o CHARACTERISTICS

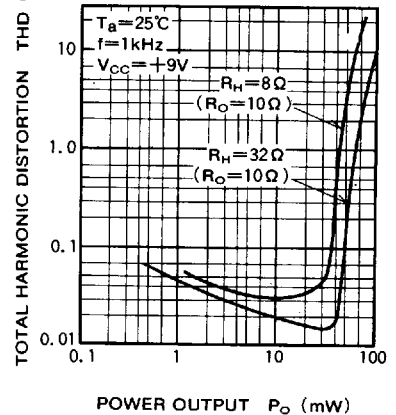

VOLTAGE GAIN VS. FREQUENCY RESPONSE

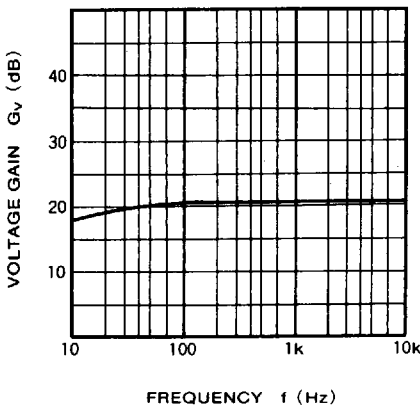

COUNTERMEASURE AGAINST OSCILLATION

If oscillation occurs due to load condition, substrate wiring condition, instability of power supply after the M5216 is mounted on the equipment, the following preventative circuit is recommended.

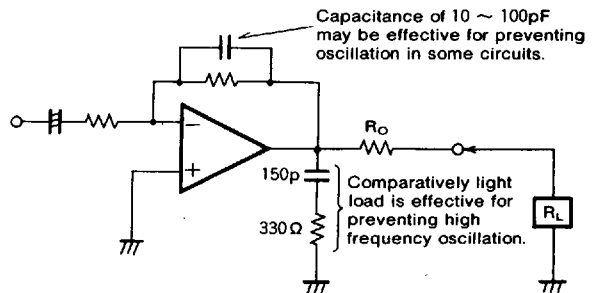

R_o is recommended because it is effective for preventing capacitive load oscillation and controlling current when load is shorted.