

WAVEFORM GENERATION FOR PROJECTION TV CONVERGENCE

DESCRIPTION

The M52336SP integrated circuit is used with projection television displays having a cathode-ray tube. It generates convergence aligning waves.

FEATURES

- Able to output 20 types of basic vertical and horizontal waves.
- The amplitude of output waveforms is not influenced by ambient temperature fluctuation.
- Able to output keystone waveforms, including those that consist of four divisions. The center positions of these divisions can be controlled simultaneously with voltage.
- Able to output the third waveforms that consist of two divisions. The output amplitudes of these divisions can be controlled simultaneously with voltage.
- The horizontal synchronizing frequency band is 13kHz thru 60kHz. The vertical synchronizing frequency band is 50Hz thru 130Hz. These operating bandwidths can be adjusted by changing external parts.

APPLICATION

Projection CRT color television displays

RECOMMENDED OPERATIONAL CONDITION

Supply voltage range..... $\pm 4.5 \sim \pm 5.5V$
 Rated supply voltage..... $\pm 5.0V$

PIN CONFIGURATION (TOP VIEW)

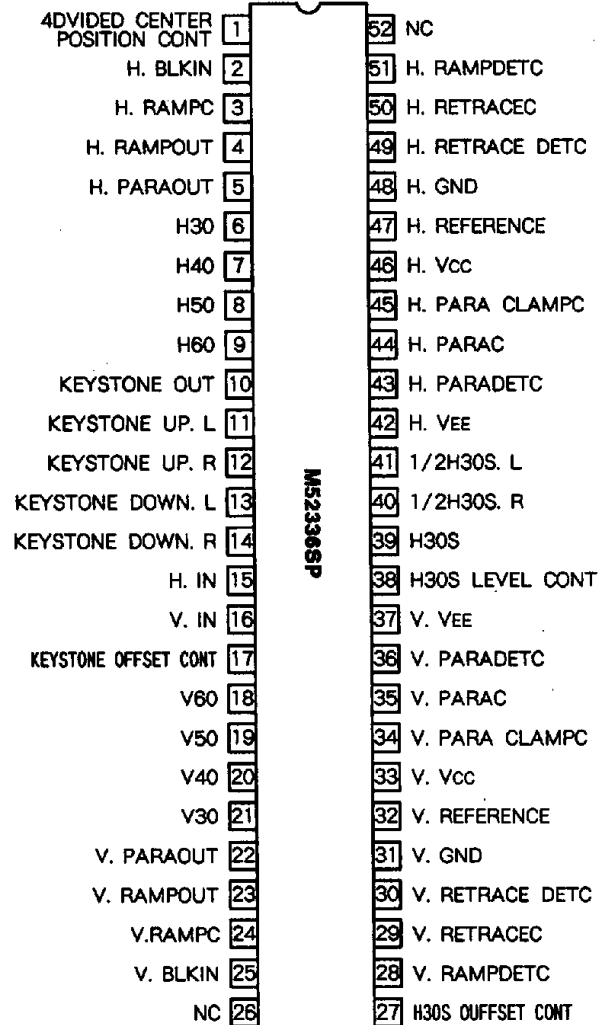

Outline 52P4B

NC : NO CONNECTED

WAVEFORM GENERATION FOR PROJECTION TV CONVERGENCE

BLOCK DIAGRAM

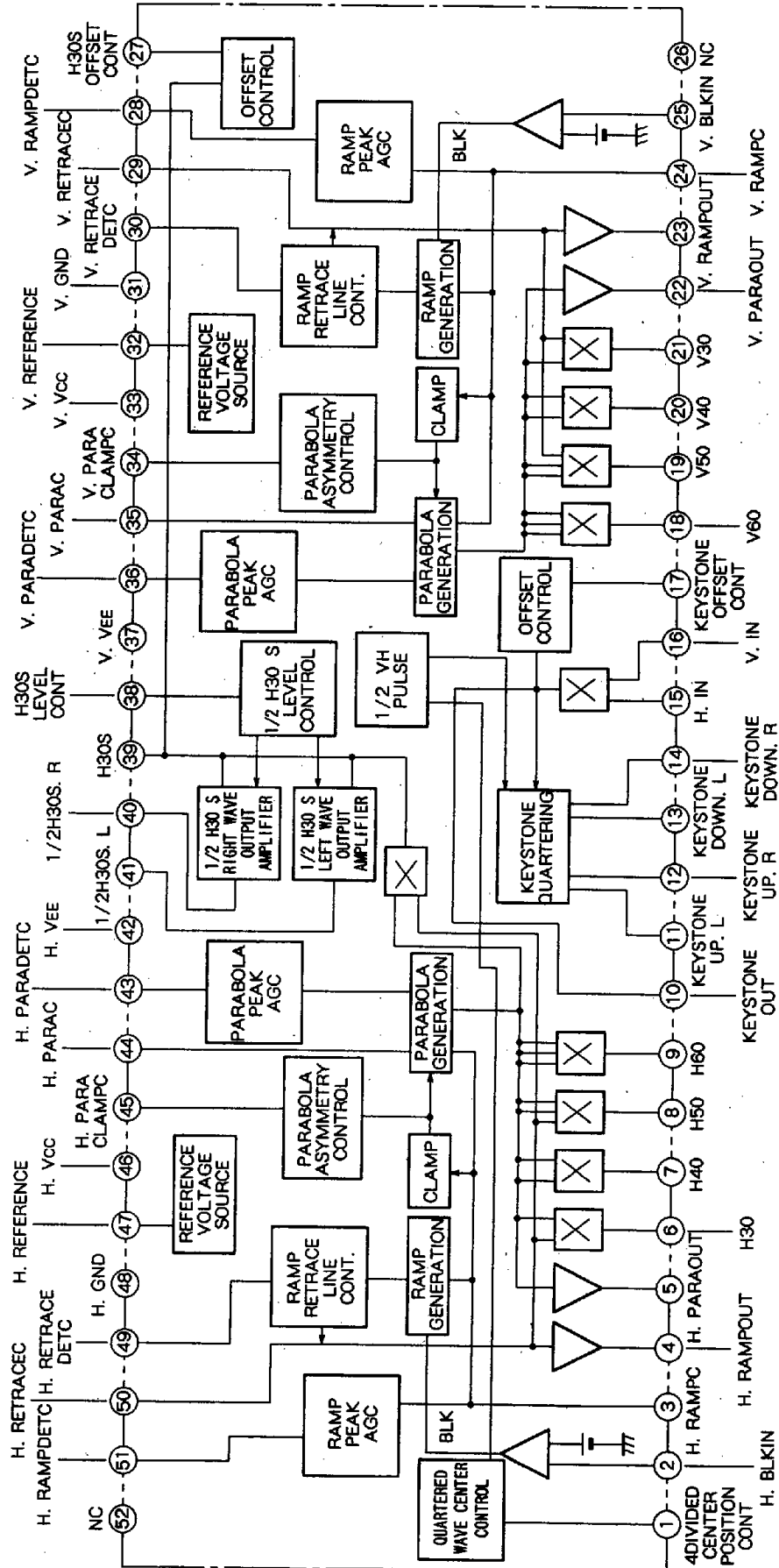

WAVEFORM GENERATION FOR PROJECTION TV CONVERGENCE

ABSOLUTE MAXIMUM RATING (Ta = 25°C, unless otherwise noted)

Symbol	Parameter	Ratings	Unit
V _{CC}	Supply voltage	+ 6.0	V
V _{EE}		- 6.0	V
P _d	Power dissipation	1.4	W
T _{opr}	Operating temperature	- 20~75	°C
T _{stg}	Storage temperature	- 30~125	°C
EIAJ	Surge voltage resistivity per pin①	+ 300, - 150	V

Recommended supply voltage : V33, V46 = + 5.0V
 : V37, V42 = - 5.0V
 Operating voltage range : V33, V46 = 4.5~5.5V
 : V37, V42 = - 4.5~- 5.5V

ELECTRICAL CHARACTERISTICS (Horizontal)

Symbol	Parameter	Test points	Input signal	Test conditions (Ta = 25°C)														Note	Limits			Unit							
				1	2	2	2	15	16	17	25	25	27	32	32	33	33		37	37	38		42	42	46	46	47	47	
ISS42	Circuit current 1	A42	-	-	ON	-	-	-	-	ON	-	-	ON	-	ON	ON	ON	ON	-	ON	ON	ON	ON	-	-	-26	-32	-41	mA
ISS46	Circuit current 2	A46	-	-	ON	-	-	-	-	ON	-	-	ON	-	ON	ON	ON	ON	-	ON	ON	ON	ON	-	-	30	38	48	mA
HBLKH	Input signal maximum amplitude voltage	2	-	-	ON	-	-	-	-	ON	-	-	ON	-	ON	ON	ON	ON	-	ON	ON	ON	ON	-	Threshold voltage 2.16V	4.0	5.0	6.0	V _{O-P}
HBLKL	Input signal minimum amplitude voltage	2	-	-	ON	-	-	-	-	ON	-	-	ON	-	ON	ON	ON	ON	-	ON	ON	ON	ON	-	-	-1.0	0	1.0	V _{O-P}
HRO	Ramp output amplitude	4	SG1	-	ON	-	-	-	-	ON	-	-	ON	-	ON	ON	ON	ON	-	ON	ON	ON	ON	-	-	2.10	2.46	2.70	V _{P-P}
HRA	Ramp AGC characteristic	4	-	-	ON	-	-	-	-	ON	-	-	ON	-	ON	ON	ON	ON	-	ON	ON	ON	ON	-	-	12	15.75	85	kHz
HRF	Ramp offset voltage	4	SG1	-	ON	-	-	-	-	ON	-	-	ON	-	ON	ON	ON	ON	-	ON	ON	ON	ON	-	-	1.05	1.23	1.35	V _{O-P}
HRRL	Ramp retrace line minimum input pulse width	4	SG1	-	ON	-	-	-	-	ON	-	-	ON	-	ON	ON	ON	ON	-	ON	ON	ON	ON	-	Pulse width variable	2.0	2.3	15	μs
HRRH	Ramp retrace line maximum input pulse width	4	SG1	-	ON	-	-	-	-	ON	-	-	ON	-	ON	ON	ON	ON	-	ON	ON	ON	ON	-	Pulse width variable	2.0	10	15	μs
HPO	Parabola output amplitude	5	SG1	-	ON	-	-	-	-	ON	-	-	ON	-	ON	ON	ON	ON	-	ON	ON	ON	ON	-	-	2.10	2.46	2.70	V _{P-P}
HPA	Parabola AGC characteristic	5	-	-	ON	-	-	-	-	ON	-	-	ON	-	ON	ON	ON	ON	-	ON	ON	ON	ON	-	-	13	15.75	85	kHz
HPF	Parabola offset voltage	5	SG1	-	ON	-	-	-	-	ON	-	-	ON	-	ON	ON	ON	ON	-	ON	ON	ON	ON	-	-	-50	8	50	mV _{O-P}
H30	Third output amplitude	6	SG1	-	ON	-	-	-	-	ON	-	-	ON	-	ON	ON	ON	ON	-	ON	ON	ON	ON	-	-	2.10	2.55	2.70	V _{P-P}
H3A	Third frequency characteristic	6	-	-	ON	-	-	-	-	ON	-	-	ON	-	ON	ON	ON	ON	-	ON	ON	ON	ON	-	-	13	15.75	80	kHz
H3F	Third offset voltage	6	SG1	-	ON	-	-	-	-	ON	-	-	ON	-	ON	ON	ON	ON	-	ON	ON	ON	ON	-	-	-80	3	80	mV _{O-P}
H40	Fourth output amplitude	7	SG1	-	ON	-	-	-	-	ON	-	-	ON	-	ON	ON	ON	ON	-	ON	ON	ON	ON	-	-	2.20	2.62	2.80	V _{P-P}
H4A	Fourth frequency characteristic	7	-	-	ON	-	-	-	-	ON	-	-	ON	-	ON	ON	ON	ON	-	ON	ON	ON	ON	-	-	13	15.75	80	kHz
H4F	Fourth offset voltage	7	SG1	-	ON	-	-	-	-	ON	-	-	ON	-	ON	ON	ON	ON	-	ON	ON	ON	ON	-	-	-300	-17	300	mV _{O-P}
H50	Fifth output amplitude	8	SG1	-	ON	-	-	-	-	ON	-	-	ON	-	ON	ON	ON	ON	-	ON	ON	ON	ON	-	-	2.10	2.63	2.70	V _{P-P}
H5A	Fifth frequency characteristic	8	-	-	ON	-	-	-	-	ON	-	-	ON	-	ON	ON	ON	ON	-	ON	ON	ON	ON	-	-	13	15.75	80	kHz

* : "-" = OPEN

WAVEFORM GENERATION FOR PROJECTION TV CONVERGENCE

ELECTRICAL CHARACTERISTICS (Horizontal) (cont.)

Symbol	Parameter	Test points	Input signal	Test conditions (Ta = 25°C)																								Note	Limits			Unit		
				1	2	2	2	15	16	17	25	25	25	27	32	32	33	33	37	37	38	42	42	46	46	47	47							
H5F	Fifth offset voltage	8	SG1	-	ON	-	-	-	-	-	ON	-	-	-	ON	-	-	ON	-	ON	ON	ON	ON	-	ON	ON	ON	ON	-		- 80	14	80	mVo-P
H60	Sixth output amplitude	9	SG1	-	ON	-	-	-	-	-	ON	-	-	-	ON	-	-	ON	-	ON	ON	ON	ON	-	ON	ON	ON	ON	-		2.10	2.60	2.70	Vp-P
H6A	Sixth frequency characteristic	9	-	-	ON	-	-	-	-	-	ON	-	-	-	ON	-	-	ON	-	ON	ON	ON	ON	-	ON	ON	ON	ON	-		13	15.75	80	kHz
A6F	Sixth offset voltage	9	SG1	-	ON	-	-	-	-	-	ON	-	-	-	ON	-	-	ON	-	ON	ON	ON	ON	-	ON	ON	ON	ON	-		- 200	- 17	200	mVo-P
3S0	Third S. output amplitude	39	SG1	-	ON	-	-	-	-	-	ON	-	-	-	ON	-	-	ON	-	ON	ON	ON	ON	-	ON	ON	ON	ON	-		2.10	2.50	2.70	Vp-P
3SA	Third S. frequency characteristic	39	-	-	ON	-	-	-	-	-	ON	-	-	-	ON	-	-	ON	-	ON	ON	ON	ON	-	ON	ON	ON	ON	-		13	15.75	60	kHz
3SF	Third S. offset voltage	39	SG1	-	ON	-	-	-	-	-	ON	-	-	-	ON	-	-	ON	-	ON	ON	ON	ON	-	ON	ON	ON	ON	-	1/2H offset	- 50	10	50	mVo-P
1/2RO	1/2 H third S. right wave output amplitude	40	SG1	-	ON	-	-	-	-	-	ON	-	-	-	ON	-	-	ON	-	ON	ON	ON	ON	-	ON	ON	ON	ON	-		2.10	2.50	2.70	Vp-P
1/2RA	1/2 H third S. left wave frequency characteristic	40	-	-	ON	-	-	-	-	-	ON	-	-	-	ON	-	-	ON	-	ON	ON	ON	ON	-	ON	ON	ON	ON	-		13	15.75	60	kHz
1/2RF	1/2 H third S. right wave GND offset voltage	40	SG1	-	ON	-	-	-	-	-	ON	-	-	-	ON	-	-	ON	-	ON	ON	ON	ON	-	ON	ON	ON	ON	-		- 50	4	50	mVo-P
1/2RC	1/2 H third S. right wave output amplitude control	40	SG1	-	ON	-	-	-	-	-	ON	-	-	-	ON	-	-	ON	-	ON	ON	ON	ON	-	ON	ON	ON	ON	-	Pin ⊕ -1.0V	1.3	1.7	2.2	Vp-P
1/2LO	1/2 H third S. left wave output amplitude	41	SG1	-	ON	-	-	-	-	-	ON	-	-	-	ON	-	-	ON	-	ON	ON	ON	ON	-	ON	ON	ON	ON	-		2.10	2.60	2.70	Vp-P
1/2LA	1/2 H third S. left wave frequency characteristic	41	-	-	ON	-	-	-	-	-	ON	-	-	-	ON	-	-	ON	-	ON	ON	ON	ON	-	ON	ON	ON	ON	-		13	15.75	60	kHz
1/2LF	1/2 H third S. left wave GND offset voltage	41	SG1	-	ON	-	-	-	-	-	ON	-	-	-	ON	-	-	ON	-	ON	ON	ON	ON	-	ON	ON	ON	ON	-		- 50	4	50	mVo-P
1/2LC	1/2 H third S. left wave output amplitude control	41	SG1	-	ON	-	-	-	-	-	ON	-	-	-	ON	-	-	ON	-	ON	ON	ON	ON	-	ON	ON	ON	ON	-	Pin ⊕ -1.0V	1.3	1.8	2.2	Vp-P
3SFC	Third S. offset control variation range	39	SG1	-	ON	-	-	-	-	-	ON	-	-	-	ON	-	-	ON	-	ON	ON	ON	ON	-	ON	ON	ON	ON	-	Variable Voltage applied to Pin②	- 50	10	50	mVo-P

* : "-" = OPEN

ELECTRICAL CHARACTERISTICS (Vertical)

Symbol	Parameter	Test points	Input signal	Test conditions (Ta = 25°C)																								Note	Limits			Unit		
				1	2	2	2	15	16	17	25	25	25	27	32	32	33	33	37	37	38	42	42	46	46	47	47							
Icc33	Circuit current 1	A33	-	-	ON	-	-	-	-	-	ON	-	-	-	ON	-	-	ON	-	ON	ON	ON	ON	-	ON	ON	ON	ON	-		19	24	31	mA
Icc37	Circuit current 2	A37	-	-	ON	-	-	-	-	-	ON	-	-	-	ON	-	-	ON	-	ON	ON	ON	ON	-	ON	ON	ON	ON	-		18	23	29	mA
VBLKH	Input signal maximum amplitude voltage	25	-	-	ON	-	-	-	-	-	ON	-	-	-	ON	-	-	ON	-	ON	ON	ON	ON	-	ON	ON	ON	ON	-	Threshold voltage 2.10V	4.0	5.0	6.0	Vo-P
VBLKL	Input signal minimum amplitude voltage	25	-	-	ON	-	-	-	-	-	ON	-	-	-	ON	-	-	ON	-	ON	ON	ON	ON	-	ON	ON	ON	ON	-		- 1.0	0	1.0	Vo-P
VRO	Ramp output amplitude	23	SG3	-	ON	-	-	-	-	-	ON	-	-	-	ON	-	-	ON	-	ON	ON	ON	ON	-	ON	ON	ON	ON	-		2.10	2.46	2.70	Vp-P
VRA	Ramp AGC characteristic	23	-	-	ON	-	-	-	-	-	ON	-	-	-	ON	-	-	ON	-	ON	ON	ON	ON	-	ON	ON	ON	ON	-		50	60	130	Hz
VRF	Ramp offset voltage	23	SG3	-	ON	-	-	-	-	-	ON	-	-	-	ON	-	-	ON	-	ON	ON	ON	ON	-	ON	ON	ON	ON	-		1.05	1.23	1.35	Vo-P

* : "-" = OPEN

M52336SP

WAVEFORM GENERATION FOR PROJECTION TV CONVERGENCE

ELECTRICAL CHARACTERISTICS (Vertical) (cont.)

Symbol	Parameter	Test points	Input signal	Test conditions (Ta = 25°C)																								Note	Limits			Unit		
				1	2	2	2	15	16	17	25	25	27	32	32	33	33	37	37	38	42	42	46	46	47	47								
VRRL	Ramp retrace line minimum input pulse width	23	SG3	-	ON	-	-	-	-	ON	-	-	-	ON	-	-	ON	-	ON	ON	ON	ON	-	-	ON	ON	ON	ON	-	Pulse width adjustable	0.5	0.6	4.5	ms
VRRH	Ramp retrace line maximum input pulse width	23	SG3	-	ON	-	-	-	-	ON	-	-	-	ON	-	-	ON	-	ON	ON	ON	ON	-	-	ON	ON	ON	ON	-	Pulse width adjustable	0.5	3.5	4.5	ms
HPO	Parabola output amplitude	22	SG3	-	ON	-	-	-	-	ON	-	-	-	ON	-	-	ON	-	ON	ON	ON	ON	-	-	ON	ON	ON	ON	-		2.10	2.46	2.70	V _{P-P}
HPA	Parabola AGC characteristic	22	-	-	ON	-	-	-	-	ON	-	-	-	ON	-	-	ON	-	ON	ON	ON	ON	-	-	ON	ON	ON	ON	-		50	60	130	Hz
HPF	Parabola offset voltage	22	SG3	-	ON	-	-	-	-	ON	-	-	-	ON	-	-	ON	-	ON	ON	ON	ON	-	-	ON	ON	ON	ON	-		-50	4	50	mV _{O-P}
H3O	Third output amplitude	21	SG3	-	ON	-	-	-	-	ON	-	-	-	ON	-	-	ON	-	ON	ON	ON	ON	-	-	ON	ON	ON	ON	-		2.10	2.55	2.70	V _{P-P}
H3A	Third frequency characteristic	21	-	-	ON	-	-	-	-	ON	-	-	-	ON	-	-	ON	-	ON	ON	ON	ON	-	-	ON	ON	ON	ON	-		50	60	130	Hz
V3F	Third offset voltage	21	SG3	-	ON	-	-	-	-	ON	-	-	-	ON	-	-	ON	-	ON	ON	ON	ON	-	-	ON	ON	ON	ON	-		80	-8	-80	mV _{O-P}
V4O	Fourth output amplitude	20	SG3	-	ON	-	-	-	-	ON	-	-	-	ON	-	-	ON	-	ON	ON	ON	ON	-	-	ON	ON	ON	ON	-		2.20	2.62	2.80	V _{P-P}
V4A	Fourth frequency characteristic	20	-	-	ON	-	-	-	-	ON	-	-	-	ON	-	-	ON	-	ON	ON	ON	ON	-	-	ON	ON	ON	ON	-		50	60	130	Hz
V4F	Fourth offset voltage	20	SG3	-	ON	-	-	-	-	ON	-	-	-	ON	-	-	ON	-	ON	ON	ON	ON	-	-	ON	ON	ON	ON	-		-300	-6	300	mV _{O-P}
V5O	Fifth output amplitude	19	SG3	-	ON	-	-	-	-	ON	-	-	-	ON	-	-	ON	-	ON	ON	ON	ON	-	-	ON	ON	ON	ON	-		2.10	2.53	2.70	V _{P-P}
V5A	Fifth frequency characteristic	19	-	-	ON	-	-	-	-	ON	-	-	-	ON	-	-	ON	-	ON	ON	ON	ON	-	-	ON	ON	ON	ON	-		50	60	130	Hz
V5F	Fifth offset voltage	19	SG3	-	ON	-	-	-	-	ON	-	-	-	ON	-	-	ON	-	ON	ON	ON	ON	-	-	ON	ON	ON	ON	-		-80	10	80	mV _{O-P}
V6O	Sixth output amplitude	18	SG3	-	ON	-	-	-	-	ON	-	-	-	ON	-	-	ON	-	ON	ON	ON	ON	-	-	ON	ON	ON	ON	-		2.10	2.50	2.70	V _{P-P}
V6A	Sixth frequency characteristic	18	-	-	ON	-	-	-	-	ON	-	-	-	ON	-	-	ON	-	ON	ON	ON	ON	-	-	ON	ON	ON	ON	-		50	60	130	Hz
V6F	Sixth offset voltage	18	SG3	-	ON	-	-	-	-	ON	-	-	-	ON	-	-	ON	-	ON	ON	ON	ON	-	-	ON	ON	ON	ON	-		-200	30	200	mV _{O-P}
KO	Keystone output amplitude	10	SG1 SG3	-	ON	-	-	ON	ON	-	ON	-	-	ON	-	-	ON	-	ON	ON	ON	ON	-	-	ON	ON	ON	ON	-		2.10	2.45	2.70	V _{P-P}
KA	Keystone frequency characteristic	10	SG2 SG4	-	ON	-	-	ON	ON	-	ON	-	-	ON	-	-	ON	-	ON	ON	ON	ON	-	-	ON	ON	ON	ON	-		2.10	2.45	2.70	V _{P-P}
KF	Keystone offset voltage	10	SG1 SG3	-	ON	-	-	ON	ON	-	ON	-	-	ON	-	-	ON	-	ON	ON	ON	ON	-	-	ON	ON	ON	ON	-	1/2V	-50	10	50	mV _{O-P}
KFC	Keystone offset control range	10	SG1 SG3	-	ON	-	-	ON	ON	Variable	ON	-	-	ON	-	-	ON	-	ON	ON	ON	ON	-	-	ON	ON	ON	ON	-	1/2V, voltage applied to pin ⑤	-50	10	50	mV _{O-P}
ULO	Keystone UL output amplitude	11	SG1 SG3	-	ON	-	-	ON	ON	-	ON	-	-	ON	-	-	ON	-	ON	ON	ON	ON	-	-	ON	ON	ON	ON	-		2.10	2.42	2.70	V _{P-P}
ULA	Keystone UL frequency characteristic	11	SG2 SG4	-	ON	-	-	ON	ON	-	ON	-	-	ON	-	-	ON	-	ON	ON	ON	ON	-	-	ON	ON	ON	ON	-		2.10	2.42	2.70	V _{P-P}
ULF	Keystone UL offset voltage	11	SG1 SG3	-	ON	-	-	ON	ON	-	ON	-	-	ON	-	-	ON	-	ON	ON	ON	ON	-	-	ON	ON	ON	ON	-		50	10	50	mV _{O-P}
ULC	Keystone UL quartered wave center control	11	SG1 SG3	35 mV	ON	-	-	ON	ON	-	ON	-	-	ON	-	-	ON	-	ON	ON	ON	ON	-	-	ON	ON	ON	ON	-		-100	0	100	μs
URO	Keystone UR output amplitude	12	SG1 SG3	-	ON	-	-	ON	ON	-	ON	-	-	ON	-	-	ON	-	ON	ON	ON	ON	-	-	ON	ON	ON	ON	-		2.10	2.45	2.70	V _{P-P}

* : "-" = OPEN

WAVEFORM GENERATION FOR PROJECTION TV CONVERGENCE

ELECTRICAL CHARACTERISTICS (Vertical) (cont.)

Symbol	Parameter	Test points	Input signal	Test conditions (Ta = 25°C)																								Note	Limits			Unit
				1	2	2	2	15	16	17	25	25	27	32	32	33	33	37	37	38	42	42	46	46	47	47	Min.		Typ.	Max.		
URA	Keystone UR frequency characteristic	12	SG2 SG4	-	ON	-	-	ON	ON	-	ON	-	-	-	ON	-	ON	ON	ON	-	ON	ON	ON	ON	-	2.10	2.45	2.70	V _{P-P}			
URF	Keystone UR offset voltage	12	SG1 SG3	-	ON	-	-	ON	ON	-	ON	-	-	-	ON	-	ON	ON	ON	-	ON	ON	ON	ON	-	-50	10	50	mV _{O-P}			
URC	Keystone UR quartered wave center control	12	SG1 SG3	35	ON	-	-	ON	ON	-	ON	-	-	-	ON	-	ON	ON	ON	-	ON	ON	ON	ON	-	-100	0	100	μs			
DLO	Keystone DL output amplitude	13	SG1 SG3	-	ON	-	-	ON	ON	-	ON	-	-	-	ON	-	ON	ON	ON	-	ON	ON	ON	ON	-	2.10	2.43	2.70	V _{P-P}			
DLA	Keystone DL frequency characteristic	13	SG2 SG4	-	ON	-	-	ON	ON	-	ON	-	-	-	ON	-	ON	ON	ON	-	ON	ON	ON	ON	-	2.10	2.43	2.70	V _{P-P}			
DLF	Keystone DL offset voltage	13	SG1 SG3	-	ON	-	-	ON	ON	-	ON	-	-	-	ON	-	ON	ON	ON	-	ON	ON	ON	ON	-	-50	10	50	mV _{O-P}			
DLC	Keystone DL quartered wave center control	13	SG1 SG3	35	ON	-	-	ON	ON	-	ON	-	-	-	ON	-	ON	ON	ON	-	ON	ON	ON	ON	-	-100	0	100	μs			
DRO	Keystone DR output amplitude	14	SG1 SG3	-	ON	-	-	ON	ON	-	ON	-	-	-	ON	-	ON	ON	ON	-	ON	ON	ON	ON	-	2.10	2.45	2.70	V _{P-P}			
DRA	Keystone DR frequency characteristic	14	SG2 SG4	-	ON	-	-	ON	ON	-	ON	-	-	-	ON	-	ON	ON	ON	-	ON	ON	ON	ON	-	2.10	2.45	2.70	V _{P-P}			
DRF	Keystone DR offset voltage	14	SG1 SG3	-	ON	-	-	ON	ON	-	ON	-	-	-	ON	-	ON	ON	ON	-	ON	ON	ON	ON	-	-50	10	50	mV _{O-P}			
DRC	Keystone DR quartered wave center control	14	SG1 SG3	35	ON	-	-	ON	ON	-	ON	-	-	-	ON	-	ON	ON	ON	-	ON	ON	ON	ON	-	-100	0	100	μs			

* : "-" = OPEN

ELECTRICAL CHARACTERISTIC MEASURING PROCEDURE

Horizontal

HRO Ramp output amplitude

Input SG1 to pin ②, and measure the pin ④ output amplitude.

HRA Ramp AGC characteristic

Change pin ② input pulse frequency to 15.75kHz and to 60kHz, and make sure that the pin ④ output amplitude is between 2.1V_{P-P} and 2.7V_{P-P}.



HRF Ramp offset voltage

Input SG1 to pin ②, and measure the offset between the pin ④ output amplitude GND level and ramp peak.

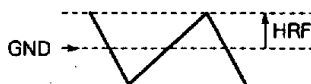

HRRL Ramp retrace line minimum input pulse width

Keeping input signal SG1 constant, change input pulse width to 2.6μs and to 10μs, and measure the ramp retrace line control range.



HRRH Ramp retrace line maximum input pulse width

HPO Parabola output amplitude

Input SG1 to pin ②, and measure the pin ⑤ output amplitude.

HPA Parabola AGC characteristic

Change pin ② input pulse frequency to 15.75kHz and to 60kHz, and make sure that the pin ⑤ output amplitude is between 2.1V_{P-P} and 2.7V_{P-P}.

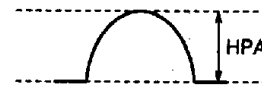

HPF Parabola offset voltage

Input SG1 to pin ②, and measure the offset between the pin ⑤ output amplitude GND level and parabola output peak voltage.

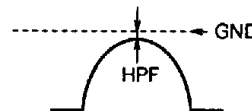

H30 Third output amplitude

Input SG1 to pin ②, and measure the pin ⑥ output amplitude.

H3A Third frequency characteristic

Change pin ② input pulse frequency to 15.75kHz and to 60kHz, and make sure that the pin ⑥ output amplitude is between 2.1V_{P-P} and 2.7V_{P-P}.

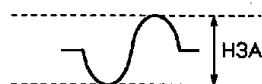

WAVEFORM GENERATION FOR PROJECTION TV CONVERGENCE

H3F Third offset voltage

Input SG1 to pin ②, and measure the offset between the GND level during the input pulse period and output wave.

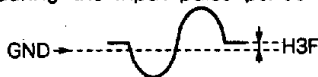

H4O Fourth output amplitude

Input SG1 to pin ②, and measure the pin ⑦ output amplitude.

H4A Fourth frequency characteristic

Change pin ② input frequency to 15.75kHz and to 60kHz, and make sure that the pin ⑦ output amplitude is between 2.2VP-P and 2.8VP-P.



H4F Fourth offset voltage

Input SG1 to pin ②, and measure the offset between the GND level during the input pulse period and output wave.

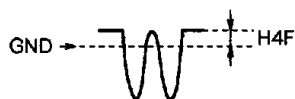

H5O Fifth output amplitude

Input SG1 to pin ②, and measure the pin ⑧ output amplitude.

H5A Fifth frequency characteristic

Change pin ② input pulse frequency to 15.75kHz and to 60kHz, and make sure that pin ⑧ output amplitude is between 2.1VP-P and 2.8VP-P.

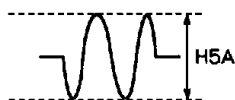

H5F Fifth offset voltage

Input SG1 to pin ②, and measure the offset between the GND level during the input pulse period and output wave.

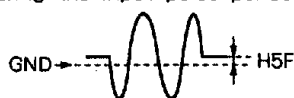

H6O Sixth output amplitude

Input SG1 to pin ②, and measure the pin ⑨ output amplitude.

H6A Sixth output frequency

Change pin ② input pulse frequency to 15.75kHz and to 60kHz, and make sure that the pin ⑨ output amplitude is between 2.1VP-P and 2.7VP-P.

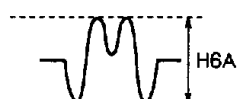

H6F Sixth offset voltage

Input SG1 to pin ②, and measure the offset between the GND level during the input pulse period and output wave.

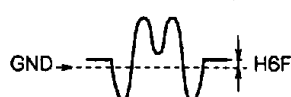

3SO Third output amplitude

Input SG1 to pin ②, and measure the pin ⑩ output amplitude.

3SA Third frequency characteristic

Change pin ② input pulse frequency to 15.75kHz and to 60kHz, and make sure that the pin ⑩ output amplitude is between 2.1VP-P and 2.7VP-P.



3SF Third offset voltage

Input SG1 to pin ②, and measure the offset between the GND level at the 1/2 H point during the input pulse period and output amplitude.

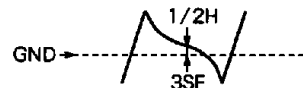

1/2RO 1/2H third S. right wave output amplitude

Input SG1 to pin ②. Set pin ⑩ to OPEN, and measure the pin ⑩ output amplitude.

1/2RA 1/2H third S. right wave frequency characteristic

Change pin ② input pulse frequency to 15.75kHz and to 60kHz, and make sure that the pin ⑩ output amplitude is between 2.1VP-P and 2.7VP-P.

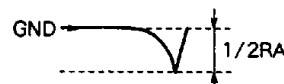

1/2RF 1/2H third S. right wave GND offset voltage

Input SG1 to pin ②, and make sure that the output wave left side is on the GND level, and that the offset is between -50mV and +50mV.

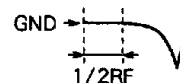

1/2RC 1/2H third S. right wave output amplitude control characteristic

Input SG1 to pin ②, and measure the output amplitude while applying -1.0V to pin ⑩.

1/2LO 1/2H third S. left wave output amplitude

Input SG1 to pin ②, and measure the pin ⑪ output amplitude with pin ⑩ set to OPEN.

1/2LA 1/2H third S. left wave frequency characteristic

Change pin ② input pulse frequency to 15.75kHz and to 60kHz, and make sure that the output amplitude is between 2.1VP-P and 2.7VP-P.

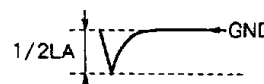

WAVEFORM GENERATION FOR PROJECTION TV CONVERGENCE

1/2LF 1/2H third S. left wave GND offset voltage

Input pin ② to SG1, and make sure that the output waveform right side is on the GND potential level, and that the offset is between -50mV and +50mV.

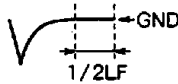

1/2LC 1/2H third S. left wave output amplitude control characteristic

Input SG1 to pin ②, and measure the output amplitude while applying -1.0V to pin ③.

3SFC Third S. offset control characteristic

Input SG1 to pin ②, and make sure that the third S offset voltage changes according to voltage applied to pin ②.

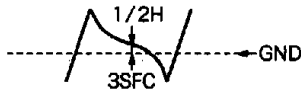

Note: Voltages V5 thru V24 shall be tested in the same way as H5 thru H24, respectively. They shall be tested while signal SG3 is applied to pin ③.

KO Keystone output amplitude

Input SG1 to pin ⑤, and SG3 to pin ⑥. Measure the pin ⑩ output amplitude.

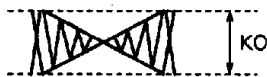

KA Keystone frequency characteristic

Input SG2 to pin ⑤, and SG4 to pin 16. Make sure that the pin ⑩ output amplitude is between 2.1VP-P and 2.7VP-P.

KF Keystone offset voltage

Input SG1 to pin ⑤, and SG3 to pin ⑥. Measure the offset from the GND level at the pin ⑩ 1/2V point.



KFC Keystone offset control range

Input SG1 to pin ⑤, and SG3 to pin ⑥. Monitor the offset from the GND level at the pin ⑩ 1/2V point, and check that the offset changes according to voltage applied to ⑦.



ULO Keystone UL output amplitude

Input SG1 to pin ⑤, and SG3 to pin ⑥. Measure the pin ⑪ output amplitude.

ULA Keystone UL frequency characteristic

Input SG2 to pin ⑤, and input SG4 to pin ⑥. Make sure that the pin ⑪ output amplitude is between 2.1VP-P and 2.7VP-P.

ULF Keystone UL offset voltage

Input SG1 to pin ⑤, and SG3 to pin ⑥. Make sure that the pin ⑪ output wave right side is on the GND level, and that the offset is between -50mV and +50mV.

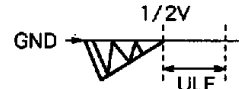

ULC Keystone UL quartered wave center control characteristic

Input SG1 to pin ⑤, and SG3 to pin ⑥. Make sure that the pin ⑪ output waveform is as shown below around the 1/2 point when 35mV is applied to pin ①, and that the center position is not displaced in excess of -100μ and +100μ.



When pin ① is open When 35mV is applied to pin ①

URO Keystone UR output amplitude

Input SG1 to pin ⑤, and SG3 to pin ⑥. Measure the pin ⑫ output amplitude.

URA Keystone UR frequency characteristic

Input SG2 to pin ⑤, and SG4 to pin ⑥. Make sure that the pin ⑫ output amplitude is in a rage between 2.1VP-P and 2.7VP-P.

URF Keystone UR offset voltage

Input SG1 to pin ⑤, and SG3 to pin ⑥. Make sure that the pin ⑫ output waveform left side is on the GND level, and that offset is between -50mV and +50mV.

URC Keystone UR quartered wave center control characteristic

Input SG1 to pin ⑤, and SG3 to pin ⑥. Make sure that when 35mV is applied to pin ①, the pin ⑫ output wave is as shown below around the 1/2 point, and that the center position is not displaced in excess of -100μ and +100μ.



When pin ① is open When 35mV is applied to pin ①

DLO Keystone DL output amplitude

Input pin SG1 to pin ⑤, and SG3 to pin ⑥. Measure the pin ⑬ output amplitude.

DLA Keystone DL frequency characteristic

Input pin SG2 to pin ⑤, and SG4 to pin ⑥. Make sure that the pin ⑬ output amplitude is between 2.1VP-P and 2.7VP-P.

DLF Keystone DL offset voltage

Input SG1 to pin ⑤, and SG3 to pin ⑥. Make sure that the pin ⑬ output amplitude right side is on the GND level, and that the offset is between -50mV and +50mV.

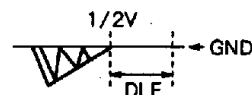

WAVEFORM GENERATION FOR PROJECTION TV CONVERGENCE

DLC Keystone DL quartered wave center control characteristic

Input SG1 to pin 15, and SG3 to pin 16. Make sure that, when 35mV is applied to pin 1, the pin 13 output waveform is as shown below around the 1/2 point, and that the center position is not displaced in excess of $-100\mu\text{s}$ and $+100\mu\text{s}$



When pin 1 is open When 35mV is applied to pin 1

DRO Keystone DR output amplitude

Input SG1 to pin 15, and input SG3 to pin 16. Measure the pin 14 output amplitude.

DRA Keystone DR frequency characteristic

Input SG2 to pin 15, and SG4 to pin 16. Make sure that pin 14 output amplitude is between 2.1Vp-p and 2.7Vp-p.

DRF Keystone DR offset voltage

Input pin 15 to SG1, and SG3 to pin 16. Make sure that pin 14 output waveform left side is on the GND level, and that the offset is between -50mV and $+50\text{mV}$.

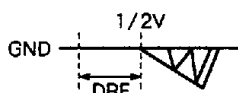

DRC Keystone DR quartered wave center control characteristic

Input pin 15 to SG1, and SG3 to pin 16. Make sure that, when 35mV is applied to pin 1, the pin 14 output waveform is as shown below around the 1/2V point, and that the center position is not displaced in excess of $-100\mu\text{s}$ and $+100\mu\text{s}$.



When pin 1 is open When 35mV is applied to pin 1

WAVEFORM GENERATION FOR PROJECTION TV CONVERGENCE

INPUT SIGNAL (BLK. IN)

SG No.	SIGNAL CONTENTS	
SG1 HORIZONTAL	f = 15.75kHz	
SG2 HORIZONTAL	f = 60.0kHz	
SG3 VERTICAL	f = 60Hz	
SG4 VERTICAL	f = 120Hz	

TYPICAL CHARACTERISTICS

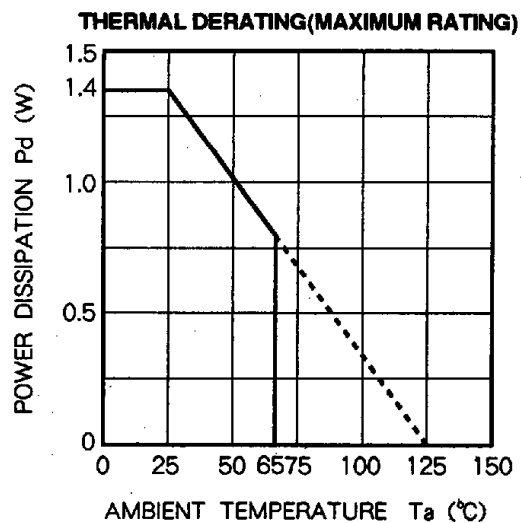

M52336SP

WAVEFORM GENERATION FOR PROJECTION TV CONVERGENCE

TEST CIRCUIT

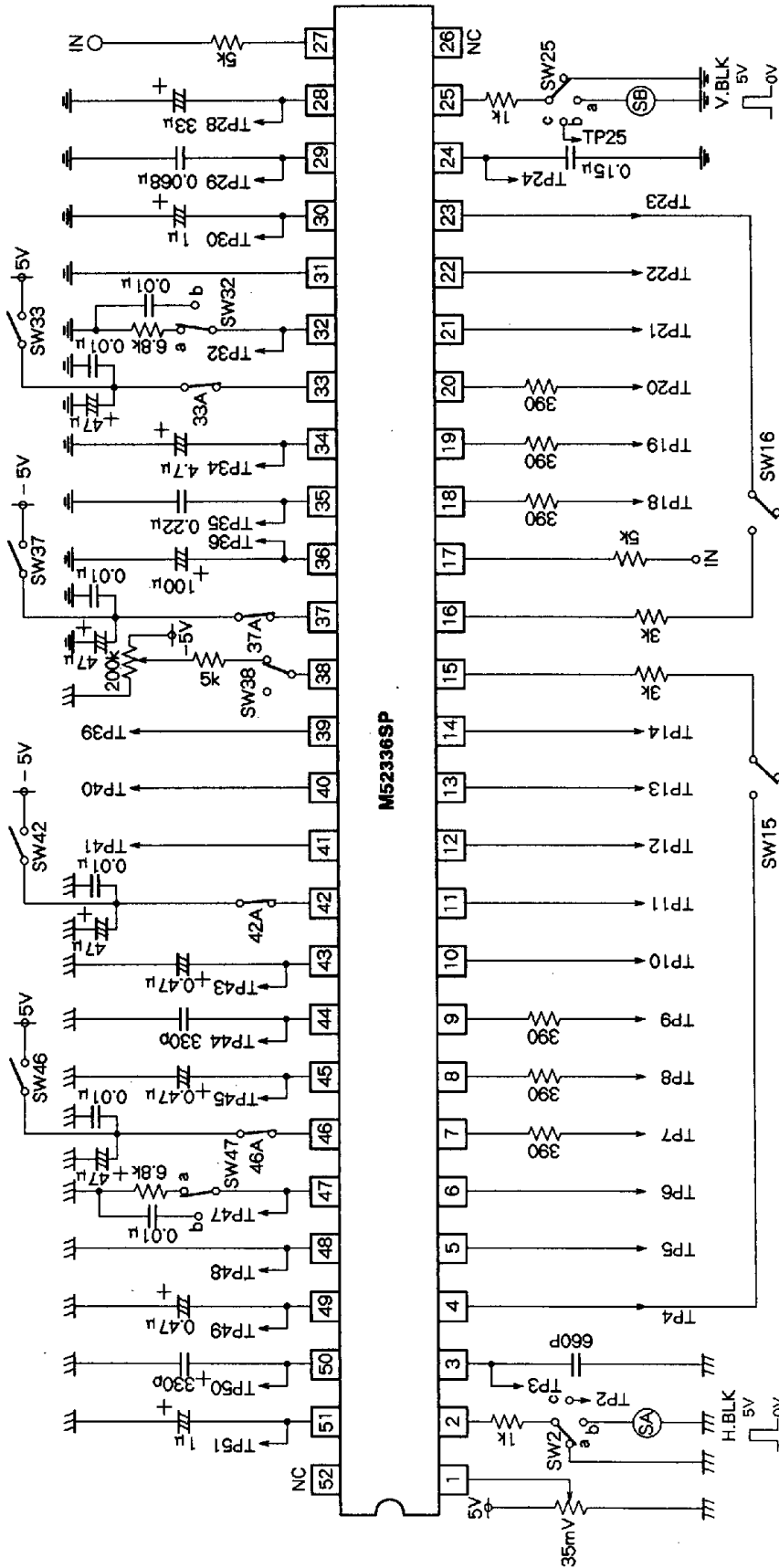

Units Resistance : Ω
 Capacitance : F
 : V.GND
 : H.GND

Note : For pins ①-③ and ⑤-⑦, connect resistance (390Ω) to the output stage to prevent output waveform oscillation.