

M52746SP

BUS CONTROLLED 3CH VIDEO PRE-AMP FOR CRT DISPLAY MONITOR

DISCRIPTION

M52746SP is Semiconductor Integrated Circuit for CRT Display Monitor.
It includes OSD Blanking, OSD Mixing, Retrace Blanking, Wide Band Amplifier, Brightness Control. Main/Sub Contrast and OSD Adjust Function can be controlled by I2C Bus.

FEATURES

- Frequency Band Width: RGB 200 MHz (at -3dB)
OSD 80 MHz

Input	: RGB	0.7 Vp-p (Typ)
	OSD light	4 Vp-p minimum (positive)
	OSD harf	2.5Vp-p minimum (positive) 3.0Vp-p maximum (positive)
	BLK(for OSD)	3 Vp-p minimum (positive)
	Retrace BLK	3 Vp-p minimum (positive)
Output	: RGB	5.5 Vp-p (maximum)
	OSD	5 Vp-p (maximum)

- Main Contrast and Sub Contrast can be controlled by I2C Bus.

PIN CONFIGURATION

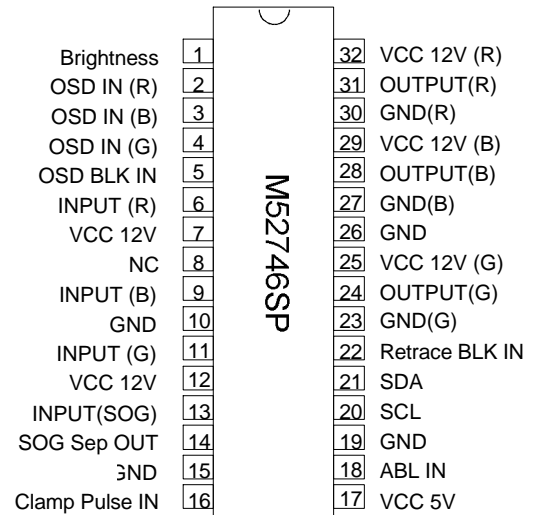

Outside Package: 32P4B

STRUCTURE

Bipolar Silicon Monolithic IC

APPLICATION

CRT Display Monitor

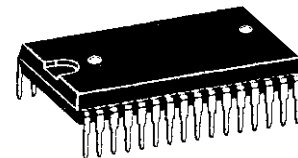

32 pin plastic SDIP

RECOMMENDED OPERATING CONDITIONS

Supply Voltage Range	11.5V~12.5V(V7,V12,V25,V29,V32)
	4.5V~4.4V(V17)
Rated Supply Voltage	12.0V(V7,V12,V25,V29,V32)
	5.0V(V17)

MAJOR SPECIFICATION

Bus Controlled 3ch Video Pre-Amp with OSD Mixing Function

M52746SP

BUS CONTROLLED 3CH VIDEO PRE-AMP FOR CRT DISPLAY MONITOR

Absolute Maximum Rating (Ambient temperature: 25 °C)

Parameter	Symbol	Rating	Unit
Supply voltage 12	Vcc12	13.0	V
Supply voltage 5	Vcc 5	6.0	V
Power dissipation	Pd	2358	mW
Ambient temperature	Topr	-20~ +75	°C
Storage temperature	Tstg	-40~ +150	°C
Recommended supply 12	Vopr 12	12.0	V
Recommended supply 5	Vopr 5	5.0	V
voltage range 12	Vopr' 12	10.5~12.5 (Typ 12.0V)	V
voltage range 5	Vopr' 5	4.5~5.5 (Typ 5.0V)	V
Case temperature	θ_{jc}	28	°C/W

Thermal Derating Curve

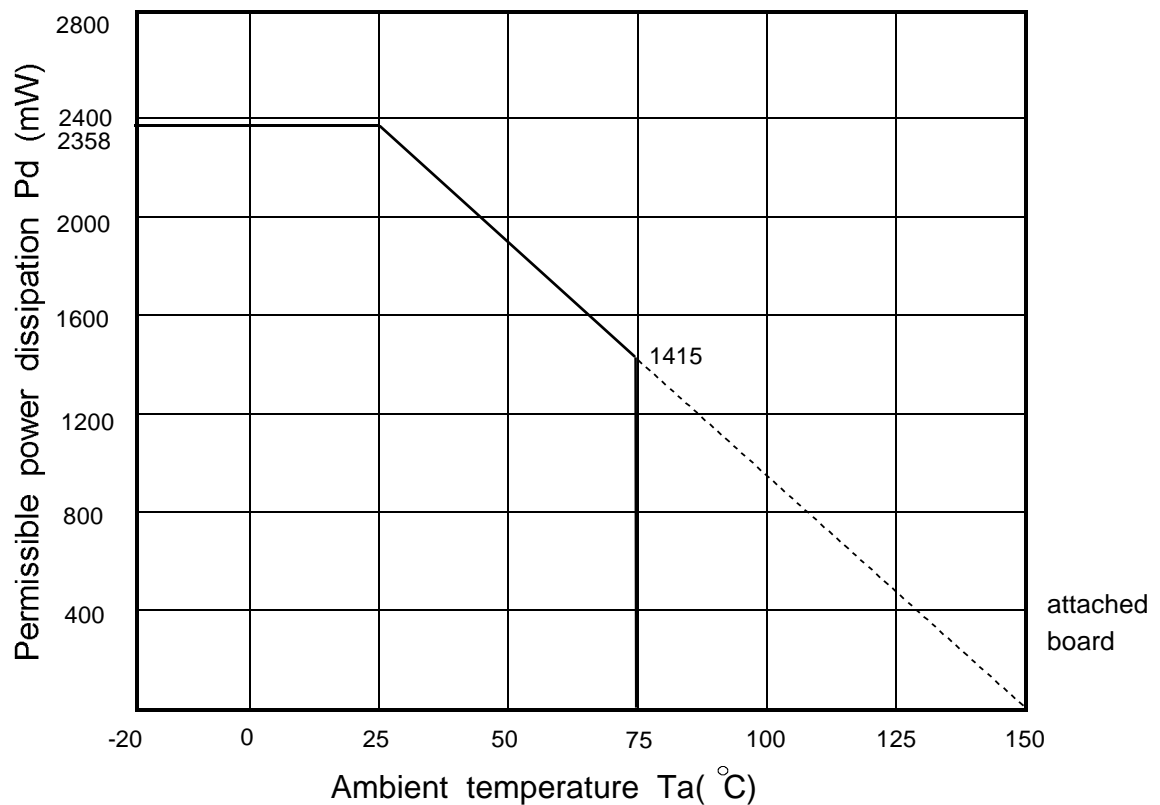

M52746SP

BUS CONTROLLED 3CH VIDEO PRE-AMP FOR CRT DISPLAY MONITOR

Fig. 1
Block Diagram

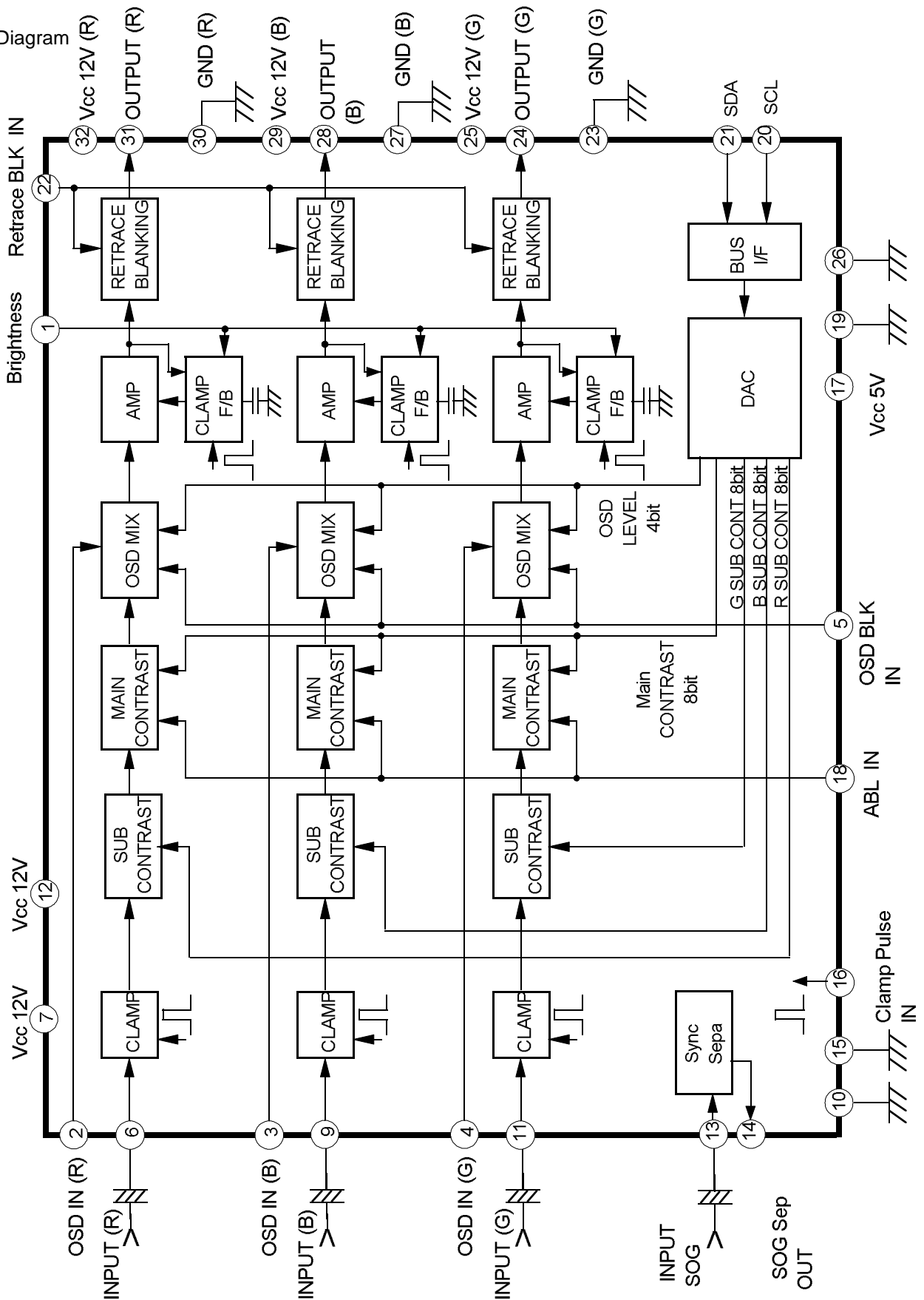

M52746SP

BUS CONTROLLED 3CH VIDEO PRE-AMP FOR CRT DISPLAY MONITOR

BUS CONTROL TABLE

(1) Slave address:

D7	D6	D5	D4	D3	D2	D1	R/W	
1	0	0	0	1	0	0	0	=88H

(2) Each function's sub address:

NO.	function	bit	sub add.	Data Byte(up:bit information down:preset)							
				D7	D6	D5	D4	D3	D2	D1	D0
1	Main contrast	8	00H	A07	A06	A05	A04	A03	A02	A01	A00
				0	1	0	0	0	0	0	0
2	Sub contrast R	8	01H	A17	A16	A15	A14	A13	A12	A11	A10
				1	0	0	0	0	0	0	0
3	Sub contrast G	8	02H	A27	A26	A25	A24	A23	A22	A21	A20
				1	0	0	0	0	0	0	0
4	Sub contrast B	8	03H	A37	A36	A35	A34	A33	A32	A31	A30
				1	0	0	0	0	0	0	0
5	OSD level	4	04H	-	-	-	-	A43	A42	A41	A40
				0	0	0	0	1	0	0	0

M52746SP

BUS CONTROLLED 3CH VIDEO PRE-AMP FOR CRT DISPLAY MONITOR

²
I C BUS CONTROL SECTION

SDA,SCL CHARACTERISTICS

parameter	symbol	MIN	MAX	unit
min. input LOW voltage.	V_{IL}	-0.5	1.5	V
max. input HIGH voltage.	V_{IH}	3.0	5.5	V
SCL clock frequency.	f_{SCL}	0	100	KHz
Time the bus must be free before a new transmission can start.	t_{BUF}	4.7	-	us
Hold time start condition. After this period the first clock pulse is generated.	$t_{HD:STA}$	4.0	-	us
The LOW period of the clock.	t_{LOW}	4.7	-	us
The HIGH period of the clock.	t_{HIGH}	4.0	-	us
Set up time for start condition. (Only relevant for a repeated start condition.)	$t_{SU:STA}$	4.7	-	us
Hold time DATA.	$t_{HD:DAT}$	0	-	us
Set-up time DATA.	$t_{SU:DAT}$	250	-	ns
Rise time of both SDA and SCL lines.	t_R	-	1000	ns
Fall time of both SDA and SCL lines.	t_F	-	300	ns
Set-up time for stop condition.	$t_{SU:STO}$	4.0	-	us

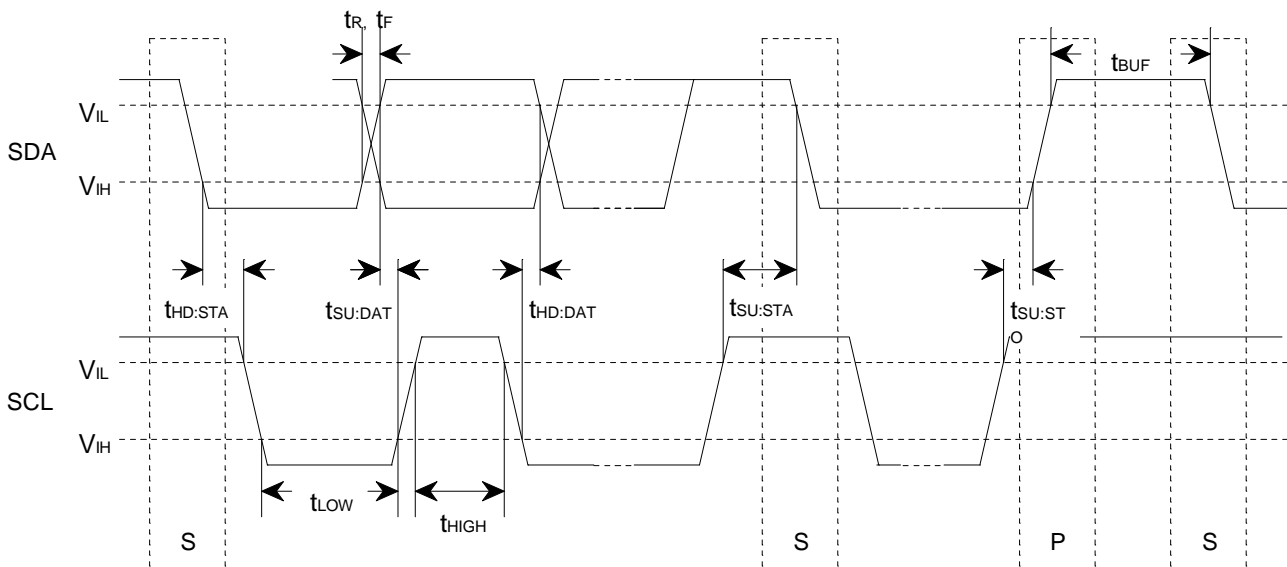

M52746SP

BUS CONTROLLED 3CH VIDEO PRE-AMP FOR CRT DISPLAY MONITOR

Supplementary Table1 Electrical Characteristics (Vcc=12V.5V; Ta=25 °C unless otherwise specified)

No	parameter	Symbol	Test Point(s)	Input							BUS CTL (H)							Standard			Re-mark	Unit
				⑦⑨⑪ RGB In	⑤ OSD BLK	②③④ OSD In	⑩ CP In	⑫ ReT BLK	⑬ SOG In	⑭ Bright	⑮ ABL	⑰ Main cont	⑱ 01H Sub cont	⑲ 02H Sub cont	⑲ 03H Sub cont	⑲ 04H OSD Adj	MIN	TYP	MAX			
1	Circuit current1	Icc1	Ia	a	a	a	b SG5	a	a	a	a	4.0	5.0	FFH 255	FFH 255	FFH 255	00H 0	-	110	135	Note1	mA
2	Circuit current2	Icc2	Ib	a	a	a	b SG5	a	a	a	a	4.0	5.0					-	18	35	Note2	mA
3	Output dynamic range	Vomax	OUT	b SG2	a	a	b SG5	a	a	a	a	Variable	5.0					6.0	8.0	-	Note3	Vp-p
4	Maximum input	Vimax	IN OUT	b SG2 Variable	a	a	b SG5	a	a	a	a	2.0	5.0	64H 100				1.6	-	-	Note4	Vp-p
5	Maximum gain	Gv	OUT	B SG1	a	a	b SG5	a	a	a	a	2.0	5.0	FFH 255				17.1	17.7	19.4	Note5	dB
6	Relative maximum gain	△Gv	-	-	-	-	-	-	-	-	-	-	-	-	-	-	-	0.8	1.0	1.2	Note6	-
7	Main contrast control characteristics 1	VC1	OUT	b AG1	a	a	b SG5	a	a	a	a	2.0	5.0	C8H 200				15.0	16.5	19.0	Note7	dB
8	Main contrast control relative characteristics 1	△VC1	-	-	-	-	-	-	-	-	-	-	-	-	-	-	-	0.8	1.0	1.2	Note8	-
9	Main contrast control characteristics 2	VC2	OUT	b SG1	a	a	b SG5	a	a	a	a	2.0	5.0	64H 100				9.0	10.5	13.0	Note9	dB
10	Main contrast control relative characteristics 2	△VC2	-	-	-	-	-	-	-	-	-	-	-	-	-	-	-	0.8	1.0	1.2	Note10	-
11	Main contrast control characteristics 3	VC3	OUT	b SG1	a	a	b SG5	a	a	a	a	2.0	5.0	14H 20				0.1	0.5	0.8	Note11	Vp-p
12	Main contrast control relative characteristics 3	△VC3	-	-	-	-	-	-	-	-	-	-	-	-	-	-	-	0.8	1.0	1.2	Note12	-
13	Sub contrast control characteristics 1	VSC1	OUT	b SG1	a	a	b SG5	a	a	a	a	2.0	5.0	FFH 255	C8H 200	C8H 200	C8H 200	15.5	16.5	19.0	Note13	dB
14	Sub contrast control relative characteristics 1	△VSC1	-	-	-	-	-	-	-	-	-	-	-	-	-	-	-	0.8	1.0	1.2	Note14	-
15	Sub contrast control characteristics 2	VSC2	OUT	b SG1	a	a	b SG5	a	a	a	a	2.0	5.0	FFH 255	64H 100	64H 100	64H 100	9.0	12.0	13.0	Note15	dB
16	Sub contrast control relative characteristics 2	△VSC2	-	-	-	-	-	-	-	-	-	-	-	-	-	-	-	0.8	1.0	1.2	Note16	-

M52746SP

BUS CONTROLLED 3CH VIDEO PRE-AMP FOR CRT DISPLAY MONITOR

No	parameter	Symbol	Test Point(s)	Input							BUS CTL (H)				Standard			Unit	Re-mark
				(7) RGB In	(9) OSD In	(11) OSD In	(13) CP In	(16) ReT In	(22) SOG In	(18) Main cont	(19) 01H Sub cont	(20) 02H Sub cont	(21) 03H Sub cont	(22) 04H OSD Adj	MIN	TYP	MAX		
17	Sub contrast control characteristics 3	VSC3	OUT	b SG1	a	a	b SG5	a	a						0.1	0.5	0.8	V/p-p	Note17
18	Sub contrast control relative characteristics 3	△VSC3	-	-	-	-	-	-	-						0.8	1.0	1.2	-	Note18
19	Main/sub contrast control characteristics	VMSC	OUT	b SG1	a	a	b SG5	a	a						3.6	4.6	4.8	V/p-p	Note19
20	Main/sub contrast control relative characteristics	△VMSC	-	-	-	-	-	-	-						0.8	1.0	1.2	-	Note20
21	ABL control characteristics 1	ABL1	OUT	b SG1	a	a	b SG5	a	a						4.7	5.5	6.3	V/p-p	Note21
22	ABL control relative characteristics 1	△ABL1	-	-	-	-	-	-	-						0.8	1.0	1.2	-	Note22
23	ABL control characteristics 2	ABL2	OUT	b SG1	a	a	b SG5	a	a						1.7	2.2	2.7	V/p-p	Note23
24	ABL control relative characteristics 2	△ABL2	-	-	-	-	-	-	-						0.8	1.0	1.2	-	Note24
25	Brightness control characteristics 1	VB1	OUT	a	a	a	b SG5	a	a						3.3	3.8	4.2	V	Note25
26	Brightness control relative characteristics 1	△VB1	-	-	-	-	-	-	-						-0.3	0	0.3	-	Note26
27	Brightness control characteristics 2	VB2	OUT	a	a	a	b SG5	a	a						1.5	1.8	2.1	V	Note27
28	Brightness control relative characteristics 2	△VB2	-	-	-	-	-	-	-						-0.3	0	0.3	-	Note28
29	Brightness control characteristics 3	VB3	OUT	a	a	a	b SG5	a	a						0.5	0.9	1.1	V	Note29
30	Brightness control relative characteristics 3	△VB3	-	-	-	-	-	-	-						-0.3	0	0.3	-	Note30
31	Frequency characteristics 1 (f=50MHz)	FC1	OUT	b SG3	a	a	a	a	a						Variable	0	2.5	dB	Note31
32	Frequency relative characteristics 1 (f=50MHz)	△FC1	-	-	-	-	-	-	-						-1.0	0	1.0	dB	Note32

M52746SP

BUS CONTROLLED 3CH VIDEO PRE-AMP FOR CRT DISPLAY MONITOR

No	parameter	Symbol	Test Point(s)	Input							CT voltage				BUS CTL (H)							Standard			Unit	Re-mark
				⑦⑨⑪ RGB In	⑤ OSD BLK	②③④ OSD In	⑬ CP In	⑫ ReT BLK	⑬ SOG In	⑬ SOG In	① Bright	① ABL	00H Main cont	01H Sub cont	02H Sub cont	03H Sub cont	04H OSD Adj	MIN	TYP	MAX						
33	Frequency characteristics 1 (f=200MHz)	FC1'	OUT	b SG3	a	a	a 5V	a	a	a	a	Variable	5.0	00H Main cont	01H Sub cont	02H Sub cont	03H Sub cont	04H OSD Adj	-3.0	0	3.0	dB	Note33			
34	Frequency relative characteristics 1 (f=200MHz)	△ FC1'	-	-	-	-	-	-	-	-	-	Variable	5.0	Variable	255	255	255	0	-1.0	0	1.0	dB	Note34			
35	Frequency characteristics 2 (f=200MHz)	FC2	OUT	b SG3	a	a	a 5V	a	a	a	a	Variable	5.0	Variable	255	255	255	0	-3.0	3.0	5.0	dB	Note35			
36	Frequency relative characteristics 2 (f=200MHz)	△ FC2	-	-	-	-	-	-	-	-	-	Variable	5.0	Variable	255	255	255	0	-1.0	0	1.0	dB	Note36			
37	Crosstalk 1 (f=50MHz)	CT1	OUT(29) OUT(32)	2 b SG3 6 a 11a	a	a	a 5V	a	a	a	a	Variable	5.0	FFH 255					-	-25	-20	dB	Note37			
38	Crosstalk 1 (f=200MHz)	CT1'	OUT(29) OUT(32)	2 b SG3 6 a 11a	a	a	a 5V	a	a	a	a	Variable	5.0						-	-20	-15	dB	Note38			
39	Crosstalk 2 (f=50MHz)	CT2	OUT(29) OUT(35)	2 a 6 b SG3 11a	a	a	a 5V	a	a	a	a	Variable	5.0						-	-25	-20	dB	Note39			
40	Crosstalk 2 (f=200MHz)	CT2'	OUT(29) OUT(35)	2 a 6 b SG3 11a	a	a	a 5V	a	a	a	a	Variable	5.0						-	-20	-15	dB	Note40			
41	Crosstalk 3 (f=50MHz)	CT3	OUT(32) OUT(35)	2 a 6 a 11b SG3	a	a	a 5V	a	a	a	a	Variable	5.0						-	-25	-20	dB	Note41			
42	Crosstalk 3 (f=200MHz)	CT3'	OUT(32) OUT(35)	2 a 6 a 11b SG3	a	a	a 5V	a	a	a	a	Variable	5.0						-	-20	-15	dB	Note42			
43	Pulse characteristics 1 (4Vp-p)	Tr	OUT	b SG1	a	a	a 5V	a	a	a	a	Variable	5.0	Variable	255				-	2.2	2.8	nS	Note43			
44	Pulse characteristics 2 (4Vp-p)	Tf	OUT	b SG1	a	a	a 5V	a	a	a	a	Variable	5.0	Variable	255				-	2.2	2.8	nS	Note44			
45	Clamp pulse threshold voltage	VthCP	OUT	b SG1	a	a	b SG5 Variable	a	a	a	a	2.0	5.0	FFH 255					1.0	1.5	2.0	V	Note45			
46	Clamp pulse minimum width	WCP	OUT	b SG1	a	a	b SG5 Variable	a	a	a	a	2.0	5.0						0.2	-	-	uS	Note46			
47	Pedestal voltage temperature characteristics 1	PDCH	OUT	b SG1	a	a	b SG5	a	a	a	a	2.0	5.0						-3.0	0	0.3	V	Note47			
48	Pedestal voltage temperature characteristics 2	PDCL	OUT	b SG1	a	a	b SG5	a	a	a	a	2.0	5.0						-3.0	0	0.3	V	Note48			

M52746SP

BUS CONTROLLED 3CH VIDEO PRE-AMP FOR CRT DISPLAY MONITOR

No	parameter	Symbol	Test Point(s)	Input							CTL voltage		BUS CTL (H)						Standard			Unit	Re-mark
				⑦⑨⑪ RGB In	⑤ OSD In BLK	②③④ OSD In	⑩ CP In	⑬ ReT BLK	⑫ SOG In	⑰ Bright	⑱ ABL	00H Main cont	01H Sub cont	02H Sub cont	03H Sub cont	04H OSD Adj	MIN	TYP	MAX				
49	OSD pulse characteristics 1	OTr	OUT	a	a	b SG6	b SG5	a	a	a	2.0	5.0	FFH 255	FFH 255	FFH 255	FFH 255	08H 8	-	3.0	6.0	ns	Note49	
50	OSD pulse characteristics 2	OTf	OUT	a	a	b SG6	b SG5	a	a	a	2.0	5.0	08H 8				08H 8	-	3.0	6.0	ns	Note50	
51	OSD adjust control characteristics 1	Oaj1	OUT	a	b SG6	b SG6	b SG5	a	a	a	2.0	5.0	0FH 15				0FH 15	5.6	6.4	7.2	Vp-p	Note51	
52	OSD adjust control relative characteristics 1	△Oaj1	-	-	-	-	-	-	-	-	-	-					-	0.8	1.0	1.2	-	Note52	
53	OSD adjust control characteristics 2	Oaj2	OUT	a	b SG6	b SG6	b SG5	a	a	a	2.0	5.0	08H 8				08H 8	3.4	4.0	4.6	Vp-p	Note53	
54	OSD adjust control relative characteristics 2	△Oaj2	-	-	-	-	-	-	-	-	-	-					-	0.8	1.0	1.2	-	Note54	
55	OSD adjust control characteristics 3	Oaj3	OUT	a	b SG6	b SG6	b SG5	a	a	a	2.0	5.0	00H 0				00H 0	0	0.7	1.2	Vp-p	Note55	
56	OSD adjust control relative characteristics 3	△Oaj3	-	-	-	-	-	-	-	-	-	-					-	0.8	1.0	1.2	-	Note56	
57	OSD input threshold voltage 1	VthOSD1	OUT	a	b SG6	b SG6 Variable	b SG5	a	a	a	2.0	5.0	08H 8				08H 8	3.1	3.5	3.9	V	Note57	
58	OSD input threshold voltage 2	VthOSD2	OUT	a	b SG6	b SG6 Variable	b SG5	a	a	a	2.0	5.0	08H 8				08H 8	1.5	2.0	2.5	V	Note58	
59	OSD BLK input threshold voltage	VthBLK	OUT	b SG1	b SG6 Variable	a	b SG5	a	a	a	2.0	5.0	00H 0				00H 0	2.2	2.7	3.2	V	Note59	
60	OSD half adjust control characteristics 1	Ohaj1	OUT	a	b SG6	b SG6 3V	b SG5	a	a	a	2.0	5.0	0FH 15				0FH 15	3.7	4.3	4.9	Vp-p	Note60	
61	OSD half adjust control characteristics 2	Ohaj2	OUT	a	b SG6	b SG6 3V	b SG5	a	a	a	2.0	5.0	08H 8				08H 8	1.9	2.5	3.0	Vp-p	Note61	
62	Retrace BLK input threshold voltage	VthRET	OUT	a	a	a	b SG5	b SG7 Variable	a	a	2.0	5.0	00H 0	→	→	→	00H 0	1.0	1.5	2.0	V	Note62	
63	SOG input maximum noise voltage	SS - NV	S on G IN Sync OUT	a	a	a	a	a	b SG4 Variable	b	2.0	5.0						-	-	0.03	Vp-p	Note63	
64	SOG minimum input voltage	SS - SV	S on G IN Sync OUT	a	a	a	a	a	b SG4 Variable	b	2.0	5.0						0.2	-	-	Vp-p	Note64	

M52746SP

BUS CONTROLLED 3CH VIDEO PRE-AMP FOR CRT DISPLAY MONITOR

Note1) Measuring conditions are as listed in supplementary Table. Measured with a current meter at test point IA.

Note2) Measuring conditions are as listed in supplementary Table. Measured with a current meter at test point IB.

Note3) Decrease V1 gradually, and measure the voltage when the bottom of waveform output is distorted. The voltage is called VOL.

Next, increase V1 gradually, and measure the voltage when the top of waveform output is distorted. The voltage is called VOH.

Voltage Vomax is calculated by the equation below:

$$V_{omax} = V_{OH} - V_{OL}$$

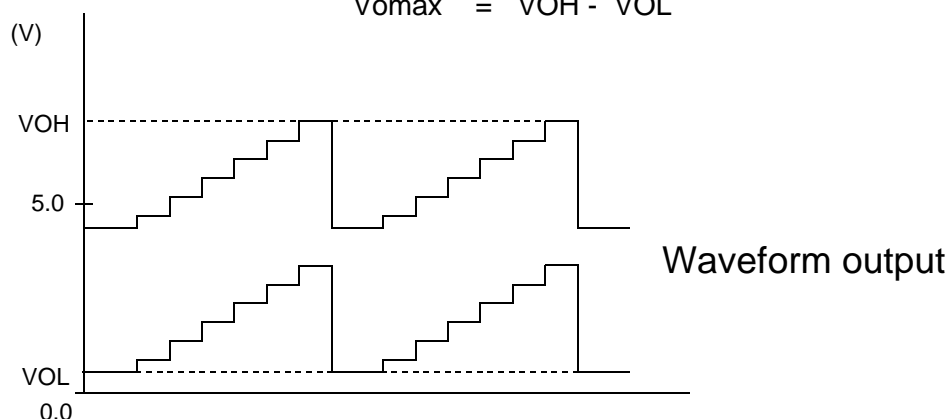

Note4) Increase the input signal(SG2) amplitude gradually, starting from 700mVp-p. Measure the amplitude of the input signal when the output signal starts becoming distorted.

Note5) Input SG1, and read the amplitude output at OUT(24,28,31). The amplitude is called VOUT(24,28,31). Maximum gain GV is calculated by the equation below:

$$GV = 20 \text{ LOG } \frac{V_{OUT}}{0.7} \quad (\text{dB})$$

Note6) Relative maximum gain ΔGV is calculated by the equation below:

$$\Delta GV = V_{OUT}(24)/V_{OUT}(18), V_{OUT}(28)/V_{OUT}(31), V_{OUT}(31)/V_{OUT}(24)$$

Note7) Measuring the amplitude output at OUT(24,28,31). The measured value is called VOUT(24,28,31).

Main contrast control characteristics VC1 is calculated by the equation below:

$$VC1 = 20 \text{ LOG } \frac{V_{OUT}}{0.7} \quad (\text{dB})$$

Note8) Relative characteristics $\Delta VC1$ is calculated by the equation below:

$$\Delta VC1 = V_{OUT}(24)/V_{OUT}(28), V_{OUT}(28)/V_{OUT}(31), V_{OUT}(31)/V_{OUT}(24)$$

Note9) Measuring condition and procedure are the same as described in Note7.

Note10) Measuring condition and procedure are the same as described in Note8.

Note11) Measuring condition and procedure are the same as described in Note7.

Note12) Measuring condition and procedure are the same as described in Note8.

Note13) Measure the amplitude output at OUT(24,28,31). The measured value is called VOUT(24,28,31).

Sub contrast control characteristics VSC1 is calculated by the equation below:

$$VSC1=20 \text{ LOG } \frac{VOUT}{0.7} \quad (\text{dB})$$

Note14) Relative characteristics $\Delta VSC1$ is calculated by the equation below:

$$VSC1=VOUT(24)/VOUT(28) , VOUT(28)/VOUT(31) , VOUT(31)/VOUT(24)$$

Note15) Measuring condition and procedure are the same as described in Note13.

Note16) Measuring condition and procedure are the same as described in Note14.

Note17) Measuring condition and procedure are the same as described in Note13.

Note18) Measuring condition and procedure are the same as described in Note14.

Note19) Measure the amplitude output at OUT(24,28,31). The measured value is called VOUT(24,28,31).

Main/Sub contrast control characteristics VMSC1 is calculated by the equation below:

$$VMSC1=20 \text{ LOG } \frac{VOUT}{0.7} \quad (\text{dB})$$

Note20) Relative characteristics $\Delta VMSC1$ is calculated by the equation below:

$$VMSC1=VOUT(24)/VOUT(28) , VOUT(28)/VOUT(31) , VOUT(31)/VOUT(24)$$

Note21) Measure the amplitude output at OUT(24,28,31). The measured value is called VOUT(24,28,31), and is treated as ABL1.

Note22) Relative characteristics $\Delta ABL1$ is calculated by the equation below:

$$ABL1=VOUT(24)/VOUT(28) , VOUT(28)/VOUT(31) , VOUT(31)/VOUT(24)$$

Note23) Measuring condition and procedure are the same as described in Note21.

Note24) Measuring condition and procedure are the same as described in Note22.

Note25) Measure the DC voltage at OUT(24,28,31) with a voltmeter. The measured value is called VOUT(24,28,31), and is treated as VB1.

Note26) Relative characteristics $\Delta VB1$ is calculated by the difference in the output between the channels.

$$VB1=VOUT(24)-VOUT(28) , VOUT(28)-VOUT(31) , VOUT(31)-VOUT(24)$$

Note27) Measuring condition and procedure are the same as described in Note25.

Note28) Measuring condition and procedure are the same as described in Note26.

Note29) Measuring condition and procedure are the same as described in Note25.

Note30) Measuring condition and procedure are the same as described in Note26.

M52746SP

BUS CONTROLLED 3CH VIDEO PRE-AMP FOR CRT DISPLAY MONITOR

Note31) First, SG3 to 1MHz is as input signal. Input a resistor that is about 2KΩ to offer the voltage at input pins(6,9,11) in order that the bottom of input signal is 2.5V.
 Control the main contrast in order that the amplitude of sine wave output is 4.0Vp-p.
 Control the brightness in order that the bottom of sine wave output is 2.0Vp-p.
 By the same way, measure the output amplitude when SG3 to 50MHz is as input signal.
 The measured value is called VOUT(24,28,31).
 Frequency characteristics FC1(24,28,31) is calculated by the equation below:

$$FC1=20 \text{ LOG } \frac{\text{VOUT Vp-p}}{\text{output amplitude when inputed SG3(1MHz) : 4.0Vp-p}} \quad (\text{dB})$$

Note32) Relative characteristics ΔFC1 is calculated by the difference in the output between the channels.

Note33) Measuring condition and procedure are the same as described in Note31, expect SG3 to 200MHz.

Note34) Relative characteristics ΔFC1' is calculated by the difference in the output between the channels.

Note35) SG3 to 1MHz is as input signal. Control the main contrast in order that the amplitude of sine wave output is 1.0Vp-p.
 By the same way, measure the output amplitude when SG3 to 200MHz is as input signal.
 The measured value is called VOUT(24,28,31).
 Frequency characteristics FC2(24,28,31) is calculated by the equation below:

$$FC2=20 \text{ LOG } \frac{\text{VOUT Vp-p}}{\text{output amplitude when inputed SG3(1MHz) : 4.0Vp-p}} \quad (\text{dB})$$

Note36) Relative characteristics ΔFC2 is calculated by the difference in the output between the channels.

Note37) Input SG3 (50MHz) to pin2 only, and then measure the waveform amplitude output at OUT(24,28,31). The measured value is called VOUT(24,28,31).
 Crosstalk CT1 is calculated by the equation below:

$$CT1=20 \text{ LOG } \frac{\text{VOUT(24,28)}}{\text{VOUT(31)}} \quad (\text{dB})$$

Note38) Measuring condition and procedure are the same as described in Note37, expect SG3 to 200MHz.

Note39) Input SG3 (50MHz) to pin6 only, and then measure the waveform amplitude output at OUT(24,28,31). The measured value is called VOUT(24,28,31).
 Crosstalk CT2 is calculated by the equation below:

$$CT2=20 \text{ LOG } \frac{\text{VOUT(24,31)}}{\text{VOUT(28)}} \quad (\text{dB})$$

Note40) Measuring condition and procedure are the same as described in Note39, expect SG3 to 200MHz.

Note41) Input SG3 (50MHz) to pin11 only, and then measure the waveform amplitude output at OUT(24,28,31). The measured value is called VOUT(24,28,31).
 Crosstalk CT2 is calculated by the equation below:

$$CT3=20 \text{ LOG } \frac{\text{VOUT(28,31)}}{\text{VOUT(24)}} \quad (\text{dB})$$

Note42) Measuring condition and procedure are the same as described in Note41, expect SG3 to 200MHz.

M52746SP

BUS CONTROLLED 3CH VIDEO PRE-AMP FOR CRT DISPLAY MONITOR

Note43) Control the main contrast (00H) in order that the amplitude of output signal is 4.0Vp-p.
Control the brightness (V1) in order that the Black level of output signal is 2.0V.
Measure the time needed for the input pulse to rise from 10 % to 90 % (Tr1) and for the output

output pulse to rise from 10 % to 90 % (Tr2) with an active probe.
Pulse characteristics Tr is calculated by the equations below :

$$Tr = \sqrt{(Tr2)^2 - (Tr1)^2} \text{ (nsec)}$$

Note44) Measure the time needed for the input pulse to fall from 90 % to 10 % (Tf1) and for the output

pulse to fall from 90 % to 10 % (Tf2) with an active probe.
Pulse characteristics Tf is calculated by the equations below :

$$Tf = \sqrt{(Tf2)^2 - (Tf1)^2} \text{ (nsec)}$$

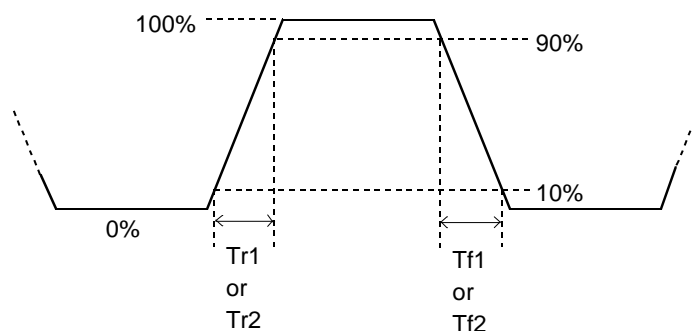

Note45) Turn down the SG5 input level gradually from 5.0Vp-p, monitoring the waveform output.
Measure the top level of input pulse when the output pedestal voltage turn decrease with unstable.

Note46) Decrease the SG5 pulse width gradually from 0.5us, monitoring the output. Measure the SG5 pulse width (a point of 1.5V) when the output pedestal voltage turn decrease with unstable.

Note47) Measure the pedestal voltage at 25°C. The measured value is called PDC1.
Measure the pedestal voltage at temperature of -20 °C. The measured value is called PDC2.

Pedestal voltage temperature characteristics 1 is calculated by the equation below:

$$PDCH = PDC1 - PDC2$$

Note48) Measure the pedestal voltage at 25°C. The measured value is called PDC1.
Measure the pedestal voltage at temperature of 75°C. The measured value is called PDC3.
Pedestal voltage temperature characteristics 2 is calculated by the equation below:

$$PDCL = PDC1 - PDC3$$

Note49) Measure the time needed for the output pulse to rise from 10% to 90%(OTR) with an active prove.

Note50) Measure the time needed for the output pulse to fall from 90% to 10% (OTF) with an active prove.

Note51) Measure the amplitude output at OUT(24,28,31). The measured value is called VOUT(24,28,31), and is treated as Oaj1.

Note52) Relative characteristics $\Delta Oaj1$ is calculated by the equation below:

$$\Delta Oaj1 = VOUT(24)/VOUT(28), VOUT(28)/VOUT(31), VOUT(31)/VOUT(24)$$

Note53) Measuring condition and procedure are the same as described in Note51.

Note54) Measuring condition and procedure are the same as described in Note52.

Note55) Measuring condition and procedure are the same as described in Note51.

Note56) Measuring condition and procedure are the same as described in Note52.

Note57) Reduce the SG6 input level gradually, monitoring output.

Measure the SG6 level when the output reaches 65~75% of first voltage. The measured value is called VthOSD1.

Note58) Reduce the SG6 input level gradually, monitoring output.

Measure the SG6 level when the output reaches 0V. The measured value is called VthOSD2.

Note59) Confirm that output signal is being blanked by the SG6 at the time.

Monitoring to output signal, decreasing the level of SG6. Measure the top level of SG6 when the blanking period is disappeared. The measured value is called VthBLK.

Note60) Measure the amplitude output at OUT(24,28,31). The measured value is called VOUT(24,28,31), and is treated as Ohaj1.

Note61) Measure the amplitude output at OUT(24,28,31). The measured value is called VOUT(24,28,31), and is treated as Ohaj2.

Note62) Confirm that output signal is being blanked by the SG7 at the time.

Monitoring to output signal, decreasing the level of SG7. Measure the top level of SG7 when the blanking period is disappeared. The measured value is called VthRET.

M52746SP

BUS CONTROLLED 3CH VIDEO PRE-AMP FOR CRT DISPLAY MONITOR

- Note63) The sync's amplitude of SG4 be changed all white into all black, increase from 0Vp-p to 0.03Vp-p. No pulse output permitted.
- Note64) The sync's amplitude of SG4 be changed all white or all black, decrease from 0.3Vp-p to 0.2Vp-p. Confirm no malfunction produced by noise.
- Note65) Measure the high voltage at SyncOUT. The measured value is treated as VSH.
- Note66) Measure the low voltage at SyncOUT. The measured value is treated as VSL.
- Note67) SyncOUT becomes High with sink part of SG4.
Measure the time needed for the rear edge of SG4 sink to fall from 50 % and for SyncOUT to rise from 50 % with an active probe. The measured value is treated as TDS-F ,less than 90nsec.
- Note68) Measure the time needed for the rear edge of SG4 sink to rise from 50 % and for SyncOUT to fall from 50 % with an active probe. The measured value is treated as TDS-R ,less than 90nsec.

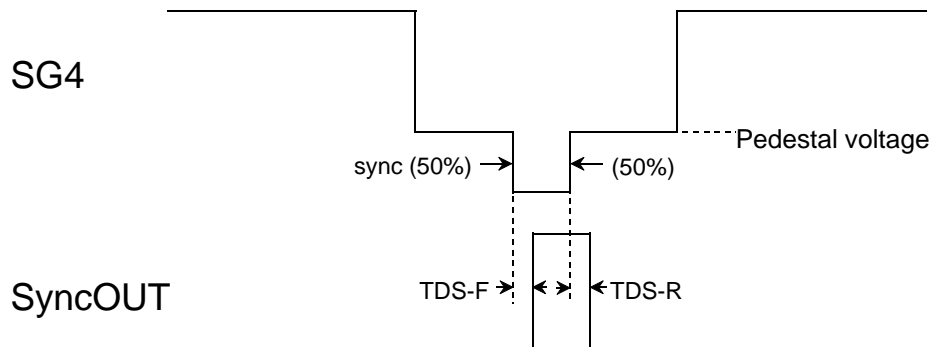

- Note69) No input at the Vcc of 12V when same condition by Note2 . Measure the AC current at Vcc(5V). The measured value is treated as Iccps.
- Note70) The Vcc of 12V be changed all white into all black, increase from 12V to 0V. Measure the DC voltage at the Vcc When no output signal at R, G and Bout. The measured value is treated as skv.

M52746SP

BUS CONTROLLED 3CH VIDEO PRE-AMP FOR CRT DISPLAY MONITOR

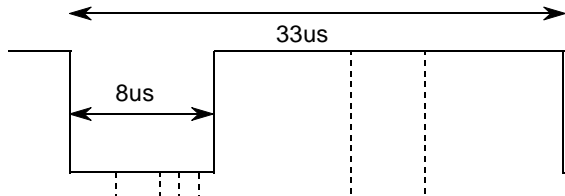
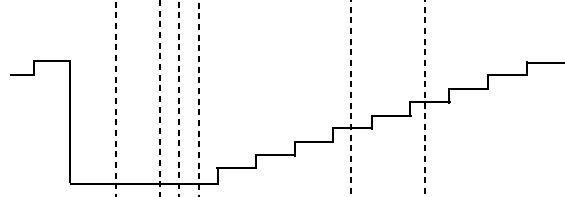
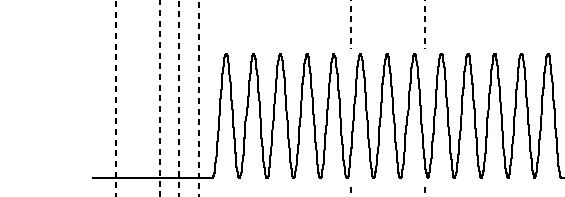
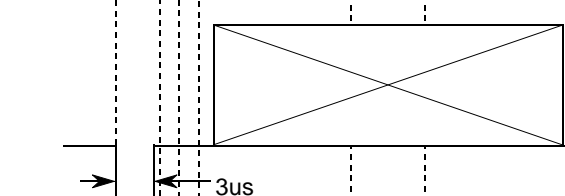
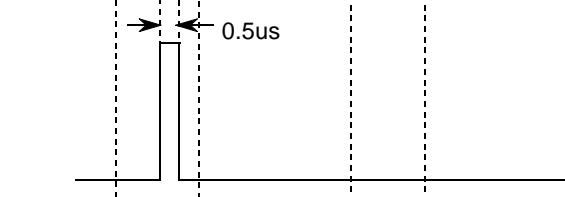
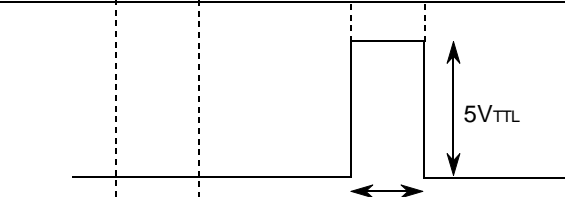
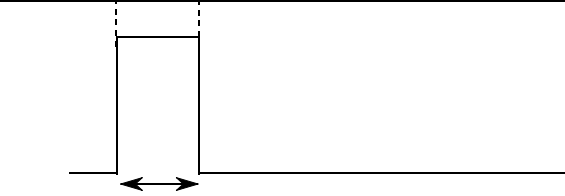
SG No.	INPUT SIGNAL
<p>SG1 Video signal (all white)</p>	 <p>Pulse with amplitude of 0.7Vp-p (f=30KHz). Video width of 25us. (75 %) 0.7V_{PP}</p>
<p>SG2 Video signal (step wave)</p>	 <p>0.7V_{P-P} (Amplitude is partially variable.)</p>
<p>SG3 Sine wave (for freq. char.)</p>	 <p>Sine wave amplitude of 0.7Vp-p. f=1MHz, 50MHz, 200MHz(variable)</p>
<p>SG4 Videosignal (all white, all black)</p>	 <p>Video width of 25us. (75 %) 0.7V_{P-P} all white or all black variable. 0.3V_{PP} Sync's amplitude is variable.</p>
<p>SG5 Clamp pulse</p>	 <p>0.5us Pulse width and amplitude are variable. 5V_{TTL}</p>
<p>SG6 OSD pulse</p>	 <p>5us 5V_{TTL} Amplitude is partially variable.</p>
<p>SG7 BLK pulse</p>	 <p>5us 5V_{TTL} Amplitude is partially variable.</p>

*)f=30KHz

M52746SP

BUS CONTROLLED 3CH VIDEO PRE-AMP FOR CRT DISPLAY MONITOR

TEST CIRCUIT

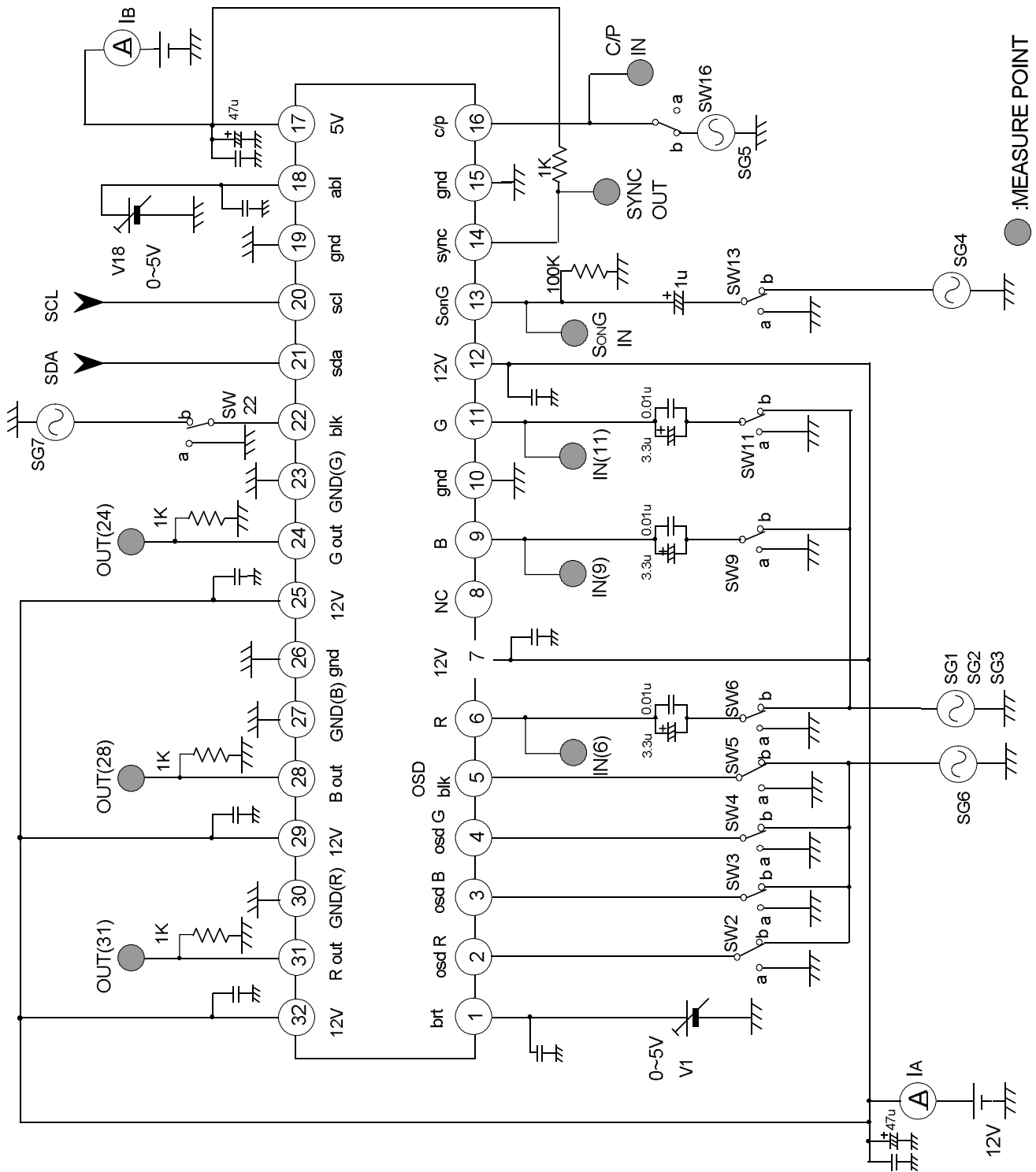

● : MEASURE POINT

* Condenser : 0.01uF (unless otherwise specified.)

M52746SP

BUS CONTROLLED 3CH VIDEO PRE-AMP FOR CRT DISPLAY MONITOR

Terminal Description

No.	Name	DC Voltage (V)	peripheral Circuit	Remark
1	Main Brightness	—		<ul style="list-style-type: none"> It is recommended that the IC be used between pedestal voltage 2V and 3V.
2	OSD IN (R)			<ul style="list-style-type: none"> Input pulses <ul style="list-style-type: none"> 4.0~5V(light) 2.5~3V(half) 1.5V~GND <ul style="list-style-type: none"> Connected to GND if not used.
3	OSD IN (B)			
4	OSD IN (G)			
5	OSD BLK IN	—		<ul style="list-style-type: none"> Input pulses <ul style="list-style-type: none"> 3.7~5V 1.7V~GND <ul style="list-style-type: none"> Connected to GND if not used.
6	INPUT (R)	2.5		<ul style="list-style-type: none"> Clamped to about 2.5 V due to clamp pulses from pin 19. Input at low impedance.
9	INPUT (B)			
11	INPUT (G)			
7	VCC	12		Vcc
12				

M52746SP

BUS CONTROLLED 3CH VIDEO PRE-AMP FOR CRT DISPLAY MONITOR

No.	Name	DC Voltage (V)	peripheral Circuit	Remark
8	NC	—	_____	_____
10 15 19 26	GND	GND	_____	_____
13	INPUT (S on G)	When open ≈ 2.5V		<ul style="list-style-type: none"> •SYNC ON VIDEO input pin. Sync is negative. input signal at Pin7, compare with the reference voltage of internal circuit in order to separate sync signal from Sync on Green signal.
14	S on G Sep OUT	—		<ul style="list-style-type: none"> •Sync signal output pin, Being of open collector output type.
16	Clamp Pulse IN	—		<ul style="list-style-type: none"> •Input pulses <ul style="list-style-type: none"> •Input at low impedance.
17	VCC (5V)	—	_____	

M52746SP

BUS CONTROLLED 3CH VIDEO PRE-AMP FOR CRT DISPLAY MONITOR

No.	Name	DC Voltage (V)	peripheral Circuit	Remark
18	ABL IN	When open 2.5V		<ul style="list-style-type: none"> •ABL(Automatic Beam Limiter) input pin. Recommended voltage range is 0 to 5V. When ABL function is not used, set to 5V.
20	SCL	—		<ul style="list-style-type: none"> •SCL of I²C BUS (Serial clock line) V_{TH}=2.3V
21	SDA	—		<ul style="list-style-type: none"> •SDA of I²C BUS (Serial data line) V_{TH}=2.3V
22	Retrace BLK IN	—		<ul style="list-style-type: none"> •Input pulses <ul style="list-style-type: none"> •Connected to GND if not used.

M52746SP

BUS CONTROLLED 3CH VIDEO PRE-AMP FOR CRT DISPLAY MONITOR

No.	Name	DC Voltage (V)	peripheral Circuit	Remark
23 27 30	GND (B) GND (G) GND (R)	0		<ul style="list-style-type: none"> •GND of Rch, Gch and Bch
24 28 31	OUTPUT (B) OUTPUT (G) OUTPUT (R)	Variable		<ul style="list-style-type: none"> •A resistor is needed on the GND side. Set discretionally to maximum 15 mA, depending on the required driving capacity.
25 29 32	VCC 2	12 Impre- - ssed		<ul style="list-style-type: none"> •Used to supply power to output emitter follower only.

Electrical Characteristics

Main Contrast Control Characteristics

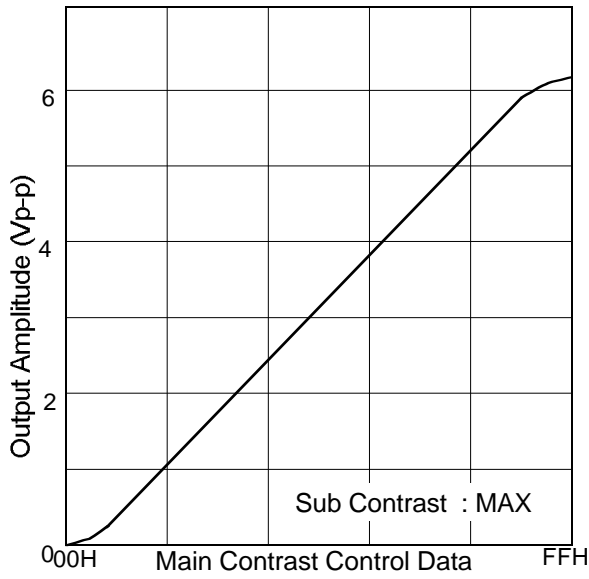

Sub Contrast Control Characteristics

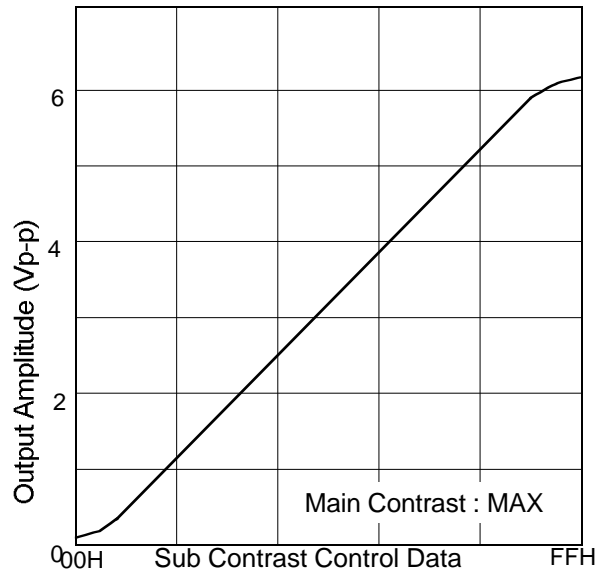

OSD Adjust Control Characteristics

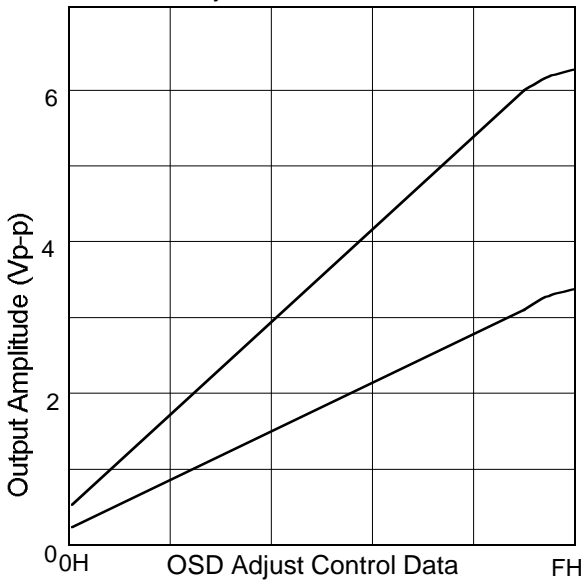

ABL Characteristics

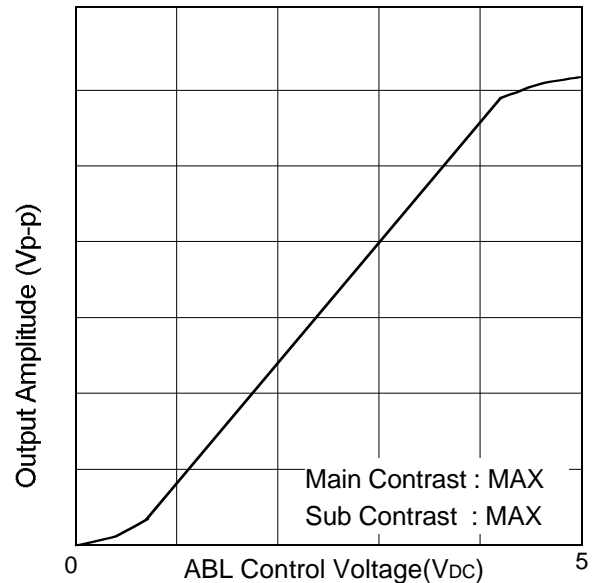

Brightness Control Characteristics

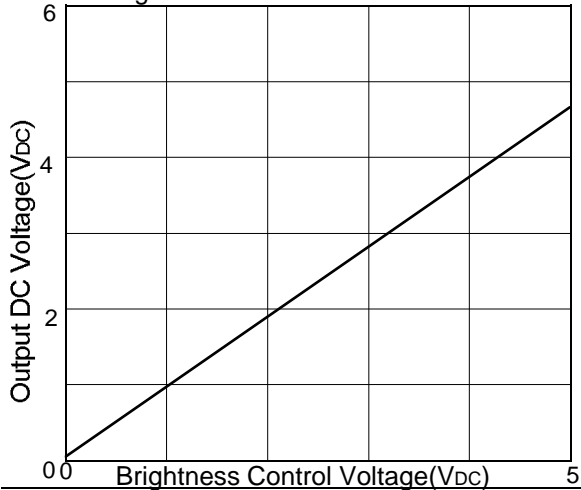

Sync separate input min sync width

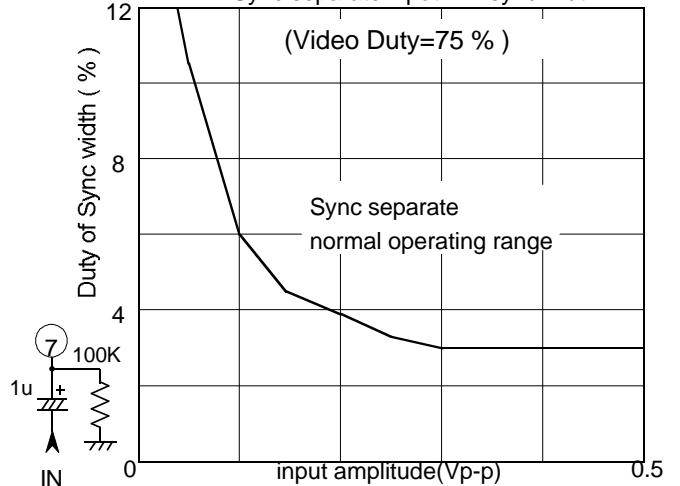

Application Method for M52746SP

CLAMP PULSE INPUT

Clamp pulse width is recommended

- above 15 KHz, 1.0 usec
- above 30 KHz, 0.5 usec
- above 64 KHz, 0.3 usec .

The clamp pulse circuit in ordinary set is a long round about way, and beside high voltage, sometimes connected to external terminal, it is very easy affected by large surge.

Therefore, the Fig. shown right is recommended.

Notice of application

Make the nearest distance between output pin and pull down resistor.

Recommended pedestal voltage of IC output signal is 2V.

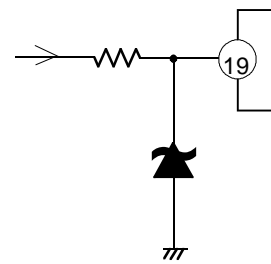

M52746SP

BUS CONTROLLED 3CH VIDEO PRE-AMP FOR CRT DISPLAY MONITOR

APPLICATION EXAMPLE

