

# M54519P/FP

7-UNIT 400mA DARLINGTON TRANSISTOR ARRAY

## DESCRIPTION

M54519P and M54519FP are seven-circuit Darlington transistor arrays. The circuits are made of NPN transistors. Both the semiconductor integrated circuits perform high-current driving with extremely low input-current supply.

## FEATURES

- High breakdown voltage ( $BV_{CEO} \geq 40V$ )
- High-current driving ( $I_{c(max)} = 400mA$ )
- Driving available with PMOS IC output
- Wide operating temperature range ( $T_a = -20$  to  $+75^\circ C$ )

## APPLICATION

Drives of relays and printers, digit drives of indication elements (LEDs and lamps), and MOS-bipolar logic IC interfaces

## FUNCTION

The M54519P and M54519FP each have seven circuits consisting of NPN Darlington transistors. These ICs have resistance of  $20k\Omega$  between input transistor bases and input pins. The output transistor emitters are all connected to the GND pin (pin 8).

Collector current is 400mA maximum. Collector-emitter supply voltage is 40V maximum.

The M54519FP is enclosed in a molded small flat package, enabling space-saving design.

## PIN CONFIGURATION

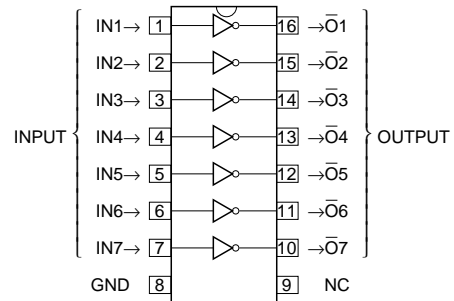

16P4(P)  
Package type 16P2N-A(FP) NC : No connection

## CIRCUIT DIAGRAM

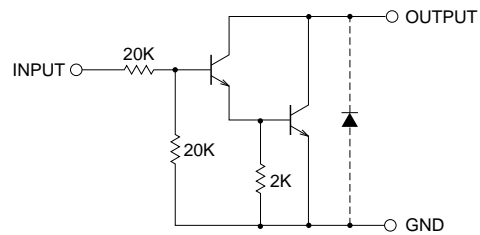

The seven circuits share the GND.

The diode, indicated with the dotted line, is parasitic, and cannot be used.

Unit :  $\Omega$

## ABSOLUTE MAXIMUM RATINGS (Unless otherwise noted, $T_a = -20 \sim +75^\circ C$ )

Symbol	Parameter	Conditions	Ratings	Unit
$V_{CEO}$	Collector-emitter voltage	Output, H	$-0.5 \sim +40$	V
$I_C$	Collector current	Current per circuit output, L	400	mA
$V_I$	Input voltage		$-0.5 \sim +40$	V
$P_d$	Power dissipation	$T_a = 25^\circ C$ , when mounted on board	1.47(P)/1.00(FP)	W
$T_{opr}$	Operating temperature		$-20 \sim +75$	$^\circ C$
$T_{stg}$	Storage temperature		$-55 \sim +125$	$^\circ C$

# M54519P/FP

## 7-UNIT 400mA DARLINGTON TRANSISTOR ARRAY

### RECOMMENDED OPERATING CONDITIONS (Unless otherwise noted, Ta = -20 ~ +75°C)

Symbol	Parameter	Limits			Unit	
		min	typ	max		
V <sub>o</sub>	Output voltage	0	—	40	V	
I <sub>c</sub>	Collector current (Current per 1 circuit when 7 circuits are coming on simultaneously)	Duty Cycle P : no more than 8% FP : no more than 6%	0	—	400	mA
		Duty Cycle P : no more than 30% FP : no more than 25%	0	—	200	
V <sub>IH</sub>	"H" input voltage	I <sub>c</sub> ≤ 400mA	8	—	30	V
		I <sub>c</sub> ≤ 200mA	5	—		
V <sub>IL</sub>	"L" input voltage		0	—	0.5	V

### ELECTRICAL CHARACTERISTICS (Unless otherwise noted, Ta = -20 ~ +75°C)

Symbol	Parameter	Test conditions	Limits			Unit
			min	typ*	max	
V (BR) CEO	Collector-emitter breakdown voltage	I <sub>CEO</sub> = 100μA	40	—	—	V
V <sub>CE (sat)</sub>	Collector-emitter saturation voltage	V <sub>I</sub> = 8V, I <sub>c</sub> = 400mA	—	1.3	2.4	V
		V <sub>I</sub> = 5V, I <sub>c</sub> = 200mA	—	1.0	1.6	
I <sub>i</sub>	Input current	V <sub>I</sub> = 17V	0.3	0.8	1.8	mA
hFE	DC amplification factor	V <sub>CE</sub> = 4V, I <sub>c</sub> = 400mA, Ta = 25°C	1000	6000	—	—

\* : The typical values are those measured under ambient temperature (Ta) of 25°C. There is no guarantee that these values are obtained under any conditions.

### SWITCHING CHARACTERISTICS (Unless otherwise noted, Ta = 25°C)

Symbol	Parameter	Test conditions	Limits			Unit
			min	typ	max	
t <sub>on</sub>	Turn-on time	C <sub>L</sub> = 15pF (note 1)	—	40	—	ns
t <sub>off</sub>	Turn-off time		—	400	—	ns

#### NOTE 1 TEST CIRCUIT

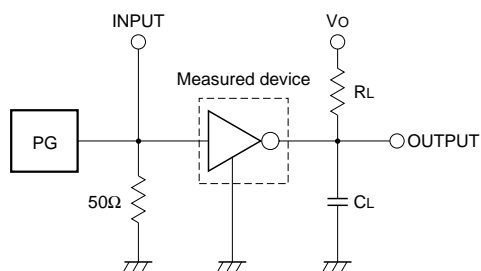

- (1) Pulse generator (PG) characteristics : PRR = 1kHz,  
t<sub>w</sub> = 10μs, t<sub>r</sub> = 6ns, t<sub>f</sub> = 6ns, Z<sub>o</sub> = 50Ω  
V<sub>P</sub> = 8VP-P
- (2) Input-output conditions : R<sub>L</sub> = 25Ω, V<sub>O</sub> = 10V
- (3) Electrostatic capacity C<sub>L</sub> includes floating capacitance at connections and input capacitance at probes

#### TIMING DIAGRAM

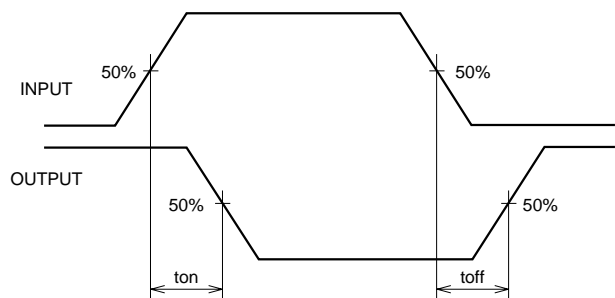

# M54519P/FP

## 7-UNIT 400mA DARLINGTON TRANSISTOR ARRAY

### TYPICAL CHARACTERISTICS

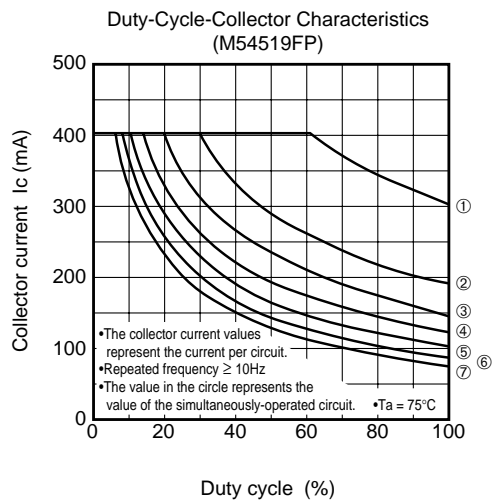
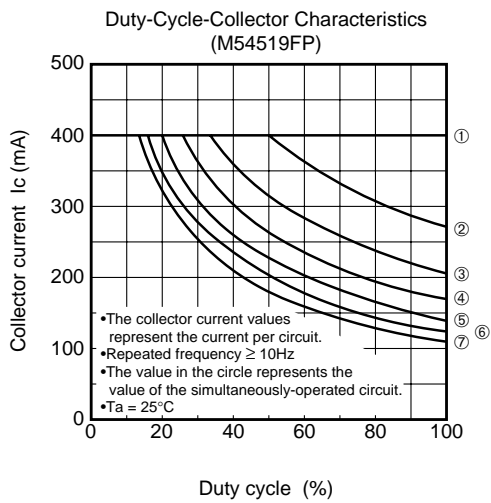
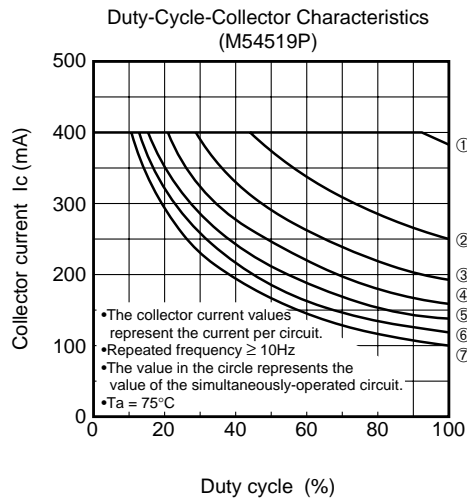
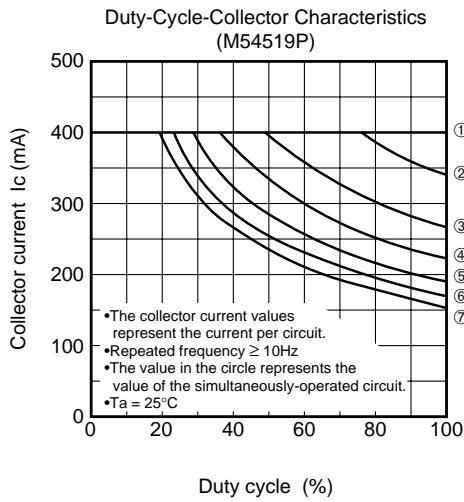
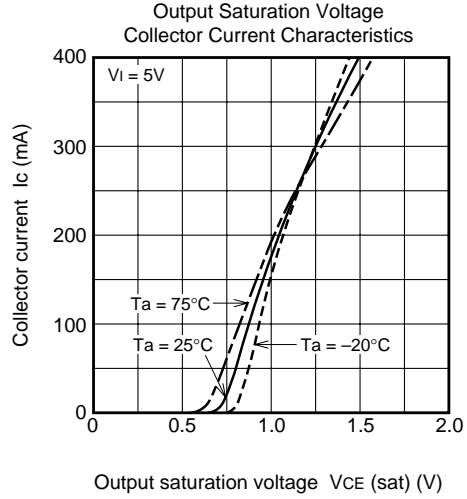
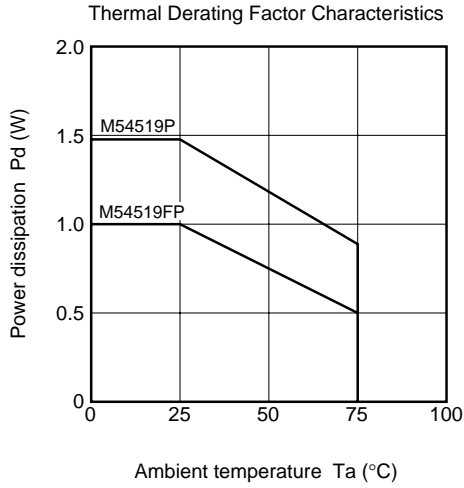

**M54519P/FP**

7-UNIT 400mA DARLINGTON TRANSISTOR ARRAY

