

M54525AGP

7-UNIT 500mA DARLINGTON TRANSISTOR-ARRAY WITH CLAMP DIODE

DESCRIPTION

M54525AGP is seven-circuit Darlington transistor array with clamping diodes. The circuits are made of NPN transistors. Both the semiconductor integrated circuits perform high-current driving with extremely low input-current supply.

FEATURES

- High breakdown voltage ($BV_{CEO} \geq 50V$)
- High-current driving ($I_{C(max)} = 500mA$)
- With clamping diodes
- Driving available with PMOS IC output of 24V
- Wide operating temperature range ($T_a = -40$ to $+85^\circ C$)

APPLICATION

Drives of relays and printers, digit drives of indication elements (LEDs and lamps), and MOS-bipolar logic IC interfaces

FUNCTION

The M54525AGP has seven circuits consisting of NPN Darlington transistors. This IC has resistance of $10.5k\Omega$ and Zener diode between input transistor bases and input pins. A spike-killer clamping diode is provided between each output pin (collector) and COM pin (pin 9). The output transistor emitters are all connected to the GND pin (pin 8). The collector current is 500mA maximum. Collector-emitter supply voltage is 50V maximum. The M54525AGP is enclosed in molded small flat package, enabling space-saving design.

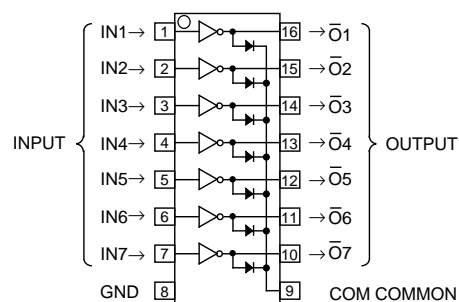
PIN CONFIGURATION

Package type 16P2S-A

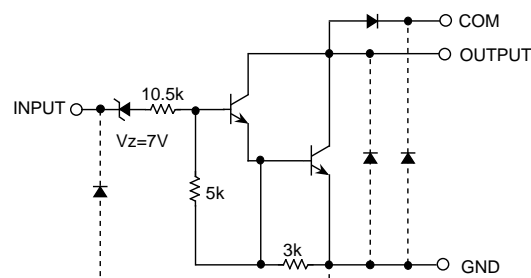
CIRCUIT DIAGRAM

The seven circuits share COM and GND.

The diode, indicated with the dotted line, parasitic, and cannot be used.

Unit: Ω **ABSOLUTE MAXIMUM RATINGS** (Unless otherwise noted, $T_a = -40 \sim +85^\circ C$)

Symbol	Parameter	Conditions	Ratings	Unit
V_{CEO}	Collector-emitter voltage	Output, H	$-0.5 \sim +50$	V
I_C	Collector current	Current per circuit output, L	500	mA
V_i	Input voltage		$-0.5 \sim +30$	V
I_F	Clamping diode forward current		500	mA
V_R	Clamping diode reverse voltage		50	V
P_d	Power dissipation	$T_a = 25^\circ C$, when mounted on board	0.80	W
T_{opr}	Operating temperature		$-40 \sim +85$	$^\circ C$
T_{stg}	Storage temperature		$-55 \sim +125$	$^\circ C$

Feb.2003

M54525AGP

7-UNIT 500mA DARLINGTON TRANSISTOR-ARRAY WITH CLAMP DIODE

RECOMMENDED OPERATING CONDITIONS (Unless otherwise noted, Ta = -40 ~ +85°C)

Symbol	Parameter	Limits			Unit	
		min	typ	max		
Vo	Output voltage	0	—	50	V	
Ic	Collector current (Current per 1 circuit when 7 circuits are coming on simultaneously)	Duty Cycle no more than 4%	0	—	400	mA
		Duty Cycle no more than 15%	0	—	200	
VIH	"H" input voltage	17	—	25	V	
VIL	"L" input voltage	0	—	6	V	

ELECTRICAL CHARACTERISTICS (Unless otherwise noted, Ta = 25°C)

Symbol	Parameter	Test conditions	Limits			Unit
			min	typ	max	
V (BR) CEO	Collector-emitter breakdown voltage	ICEO = 100μA	50	—	—	V
VCE(sat)	Collector-emitter saturation voltage	II = 500μA, IC = 350mA	—	1.2	1.6	V
		II = 350μA, IC = 200mA	—	1.0	1.3	
		II = 250μA, IC = 100mA	—	0.9	1.1	
II	Input current	VI = 17V	—	0.8	1.3	mA
VF	Clamping diode forward voltage	IF = 350mA	—	1.3	2.0	V
IR	Clamping diode reverse current	VR = 50V	—	—	100	μA
hFE	DC amplification factor	VCE = 2V, IC = 350mA	1000	2000	—	—

SWITCHING CHARACTERISTICS (Unless otherwise noted, Ta = 25°C)

Symbol	Parameter	Test conditions	Limits			Unit
			min	typ	max	
ton	Turn-on time	CL = 15pF (note 1)	—	5	—	ns
toff	Turn-off time		—	100	—	

NOTE 1 TEST CIRCUIT

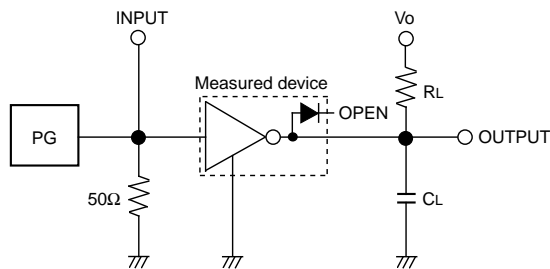

- (1) Pulse generator (PG) characteristics : PRR = 1kHz, tw = 10μs, tr = 6ns, tf = 6ns, Zo = 50Ω, VIH = 17V
- (2) Input-output conditions : RL = 25Ω, Vo = 10V
- (3) Electrostatic capacity CL includes floating capacitance at connections and input capacitance at probes

TIMING DIAGRAM

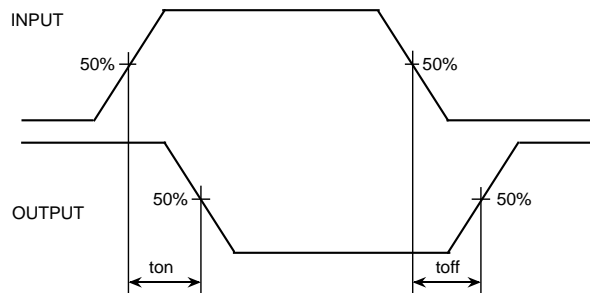

7-UNIT 500mA DARLINGTON TRANSISTOR-ARRAY WITH CLAMP DIODE

TYPICAL CHARACTERISTICS

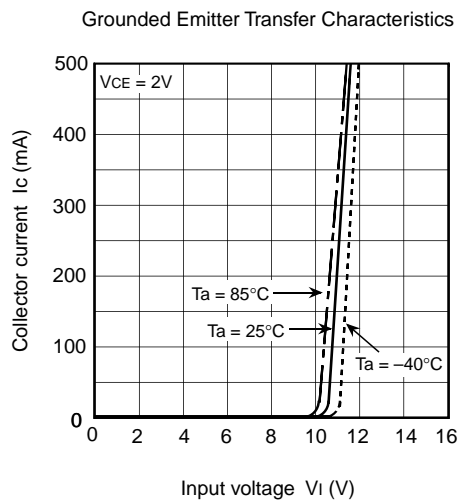
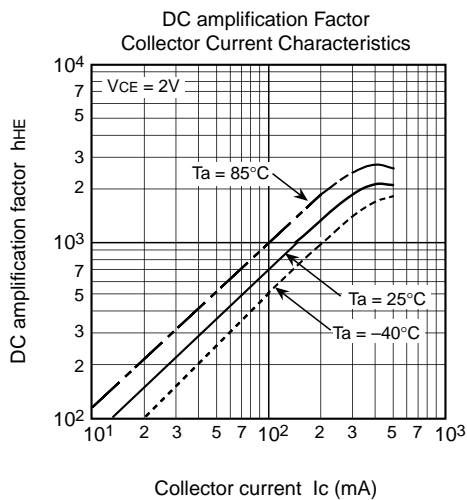
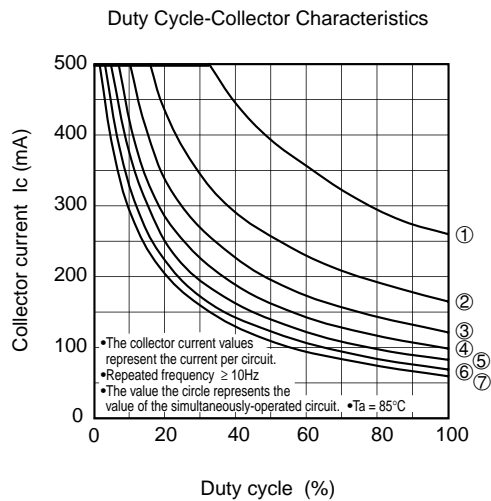
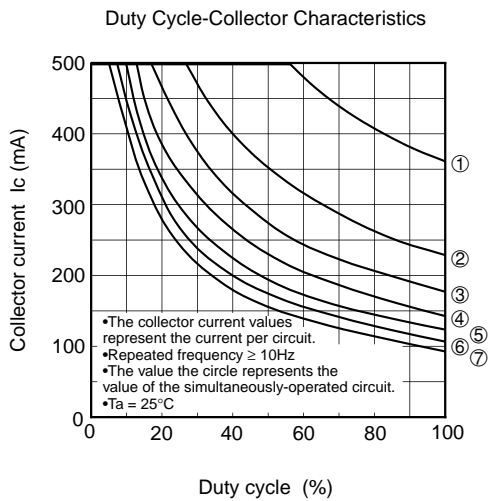
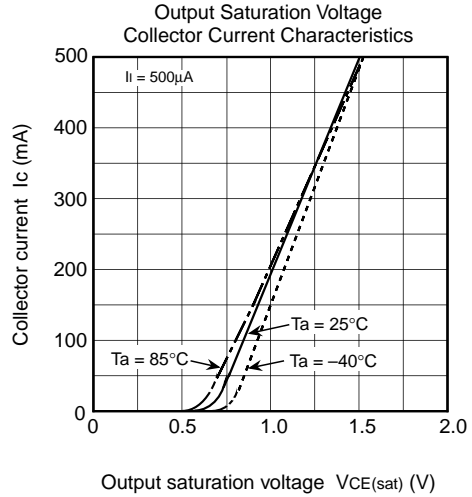
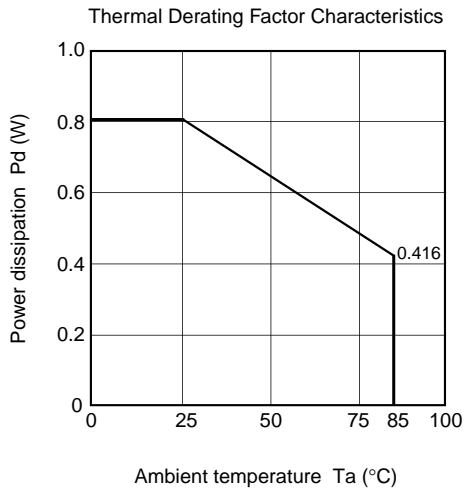

M54525AGP

7-UNIT 500mA DARLINGTON TRANSISTOR-ARRAY WITH CLAMP DIODE

