

7-UNIT 400mA DARLINGTON TRANSISTOR ARRAY WITH CLAMP DIODE

6249826 MITSUBISHI ELEK (LINEAR)

80C 09269 D 7-43-25

DESCRIPTION

The M54530P, 7-channel sink driver, consists of 14 NPN transistors connected to form seven high current gain driver pairs.

FEATURES

- High output sustaining voltage to 40V
- High output sink current to 400mA
- Integral diodes for transient suppression
- PMOS compatible input
- Wide operating temperature range ($T_a = -20 \sim +75^\circ\text{C}$)

APPLICATION

Relay and printer driver, LED or incandescent display digit driver, Interfacing for standard MOS/BIPOLAR logics

FUNCTION

The M54530P is comprised of seven NPN darlington driver pairs with $20\text{k}\Omega$ series input resistors. Between pin 9 and each output, there are integral diodes for inductive load transient suppression. All emitters and the substrate are connected together to pin 8. The outputs are capable of sinking 400mA and will withstand 40V in the OFF state.

PIN CONFIGURATION (TOP VIEW)

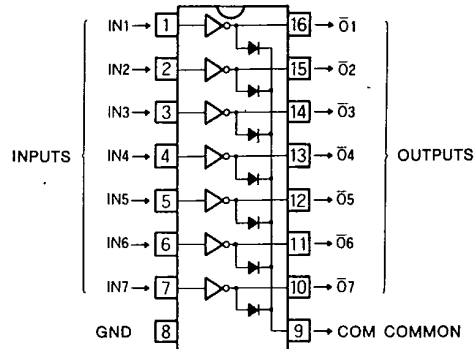

Outline 16P4

CIRCUIT SCHEMATIC

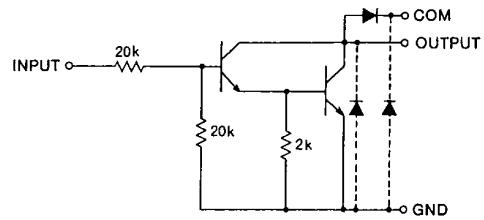

Unit : Ω

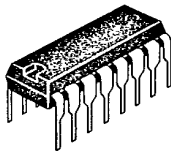

16-pin molded plastic DIP

ABSOLUTE MAXIMUM RATINGS ($T_a = -20 \sim +75^\circ\text{C}$, unless otherwise noted)

Symbol	Parameter	Conditions	Ratings	Unit
V_{CEO}	Output sustaining voltage	Transistor OFF	-50 ~ +40	V
I_C	Collector current	Transistor ON	400	mA
V_I	Input voltage		40	V
I_F	Clamp diode forward current		400	mA
V_R	Clamp diode reverse voltage		40	V
P_d	Power dissipation	$T_a = 25^\circ\text{C}$	1.47	W
T_{opr}	Operating ambient temperature range		-20 ~ +75	$^\circ\text{C}$
T_{stg}	Storage temperature range		-55 ~ +125	$^\circ\text{C}$

7-UNIT 400mA DARLINGTON TRANSISTOR ARRAY WITH CLAMP DIODE

6249826 MITSUBISHI ELEK (LINEAR) 80C 09270 D7-43-25

RECOMMENDED OPERATIONAL CONDITIONS (T_a = -20~+75°C, unless otherwise noted)

Symbol	Parameter		Limits			Unit
			Min	Typ	Max	
V _O	Output voltage		0		40	V
I _C	Collector current per channel	Percent duty cycle less than 8%	0		400	mA
		Percent duty cycle less than 30%	0		200	
V _{IH}	"H" Input voltage	I _C = 400mA	8		35	V
		I _C = 200mA	5		35	V
V _{IL}	"L" Input voltage	I _{oleak} = 50μA	0		0.5	V

ELECTRICAL CHARACTERISTICS (T_a = -20~+75°C, unless otherwise noted)

Symbol	Parameter	Test conditions	Limits			Unit
			Min	Typ*	Max	
V _{(BR)CEO}	Output sustaining voltage	I _{CEB} = 100μA	40			V
V _{CE(sat)}	Output saturation voltage	V _I = 8V, I _C = 400mA		1.3	2.4	V
		V _I = 5V, I _C = 200mA		1	1.6	
I _I	Input current	V _I = 17V		0.85	1.8	mA
		V _I = 35V		2.0	3.8	
V _F	Clamp diode forward voltage	I _{FDI} = 400mA		1.5	2.4	V
V _R	Clamp diode reverse voltage	V _{RDI} = 100μA	40			V
h _{FE}	DC forward current gain	V _{CE} = 4V, I _C = 300mA, T _B = 25°C	1000	3500		—

* : All typical values are at T_a = 25°C.

TYPICAL CHARACTERISTICS

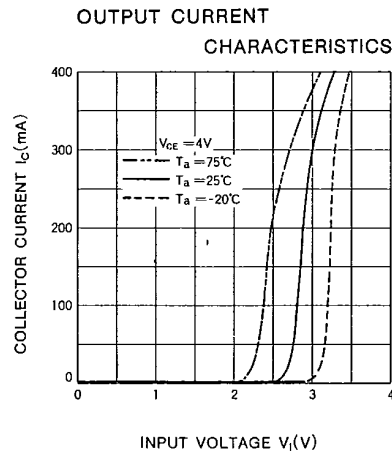
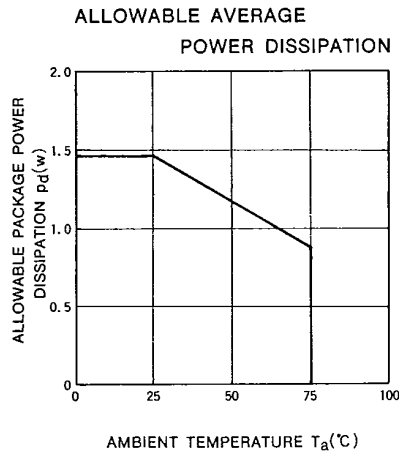

7-UNIT 400mA DARLINGTON TRANSISTOR ARRAY WITH CLAMP DIODE

6249826 MITSUBISHI ELEK (LINEAR)

80C 09271 D 7-43-25

ALLOWABLE COLLECTOR CURRENT AS A FUNCTION OF DUTY CYCLE

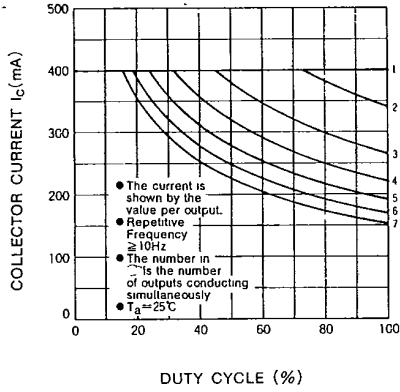

ALLOWABLE COLLECTOR CURRENT AS A FUNCTION OF DUTY CYCLE

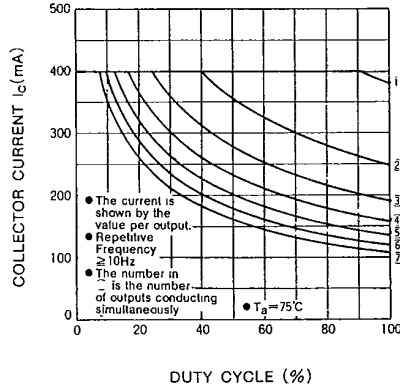

DC CURRENT GAIN CHARACTERISTICS

