

# M54566DP

7-UNIT 400mA DARLINGTON TRANSISTOR ARRAY

## DESCRIPTION

M54566DP is seven-circuit collector current sink type darlington transistor arrays. The circuits are made of PNP and NPN transistors. Both the semiconductor integrated circuits perform high-current driving with extremely low input-current supply.

## FEATURES

- High breakdown voltage ( $BV_{CE0} \geq 50V$ )
- High-current driving ( $I_c(\max) = 400mA$ )
- Active L-level input

## APPLICATIONS

Interfaces between microcomputers and high-voltage, high-current drive systems, drives of relays and printers, and MOS-bipolar logic IC interfaces.

## FUNCTION

The M54566 is produced by adding PNP transistors to M54522 inputs. Seven circuits having active L-level inputs are provided.

Resistance of  $8k\Omega$  is provided between each input and PNP transistor base. The input emitters are connected to  $V_{cc}$  pin (pin 9). Output transistor emitters are all connected to the GND pin (pin 8).

Collector current is 400mA maximum. Collector-emitter supply voltage is 50V maximum.

These ICs are optimal for drivers that are driven with N-MOSIC output and absorb collector current.

## PIN CONFIGURATION

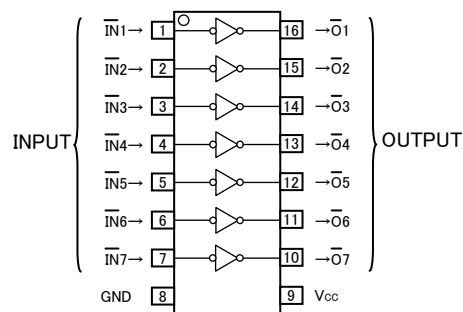

Package type 16P2X-B

## CIRCUIT DIAGRAM

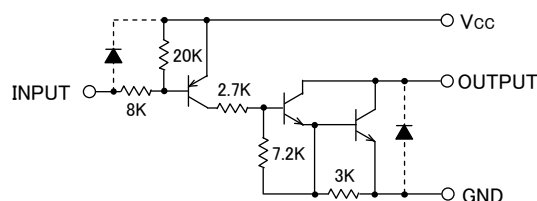

The seven circuits share the  $V_{cc}$  and GND.  
The diode, indicated with the dotted line, is parasitic, and cannot be used.

Unit:  $\Omega$

## ABSOLUTE MAXIMUM RATINGS (Unless otherwise noted, $T_a = -20 \sim +75^\circ C$ )

Symbol	Parameter	Conditions	Ratings	Unit
$V_{cc}$	Supply voltage		10	V
$V_{CE0}$	Collector-emitter voltage	Output, H	- 0.5 ~ + 50	V
$I_c$	Collector current	Current per circuit output, L	400	mA
$V_i$	Input voltage		- 0.5 ~ $V_{cc}$	V
$P_d$	Power dissipation	$T_a = 25^\circ C$ , when mounted on board	1.00	W
$T_{opr}$	Operating temperature		- 20 ~ + 75	$^\circ C$
$T_{stg}$	Storage temperature		- 55 ~ + 125	$^\circ C$

**RECOMMENDED OPERATING CONDITIONS**

Symbol	Parameter	Limits			Unit	
		min	typ	max		
V <sub>CC</sub>	Supply voltage	4	5	8	V	
V <sub>O</sub>	Output voltage	0	—	50	V	
I <sub>C</sub>	Collector current (Current per 1 circuit when 7 circuits are coming on simultaneously) V <sub>CC</sub> =5V	Duty Cycle no more than 6%	0	—	350	mA
		Duty Cycle no more than 20%	0	—	200	
V <sub>IH</sub>	“H” input voltage	V <sub>CC</sub> -0.2	—	V <sub>CC</sub>	V	
V <sub>IL</sub>	“L” input voltage	0	—	V <sub>CC</sub> -3	V	

**ELECTRICAL CHARACTERISTICS** (Unless otherwise noted, T<sub>a</sub> = -20~+75°C)

Symbol	Parameter	Test conditions	Limits			Unit
			min	typ*	max	
V <sub>(BR)CEO</sub>	Collector-emitter breakdown voltage	I <sub>CEO</sub> = 100 μA	50	—	—	V
V <sub>CE(sat)</sub>	Collector-emitter saturation voltage	V <sub>I</sub> = V <sub>CC</sub> -3V	—	1.1	2.2	V
		I <sub>C</sub> = 350mA I <sub>C</sub> = 200mA	—	0.9	1.6	
I <sub>I</sub>	Input current	V <sub>I</sub> = V <sub>CC</sub> -3.5V	—	-0.3	-0.58	mA
I <sub>CC</sub>	Supply current (one circuit coming on)	V <sub>CC</sub> = 5V, V <sub>I</sub> = V <sub>CC</sub> -3.5V	—	1.4	3.0	mA
h <sub>FE</sub>	DC amplification factor	V <sub>CE</sub> = 4V, V <sub>CC</sub> = 5V, I <sub>C</sub> = 350mA, T <sub>a</sub> = 25°C	2000	10000	—	—

\*: The typical values are those measured under ambient temperature (T<sub>a</sub>) of 25°C. There is no guarantee that these values are obtained under any conditions.

**SWITCHING CHARACTERISTICS** (Unless otherwise noted, T<sub>a</sub> = 25°C)

Symbol	Parameter	Test conditions	Limits			Unit
			min	typ	max	
t <sub>on</sub>	Turn-on time	C <sub>L</sub> = 15pF (note 1)	—	95	—	ns
t <sub>off</sub>	Turn-off time		—	2500	—	ns

**NOTE 1 TEST CIRCUIT**

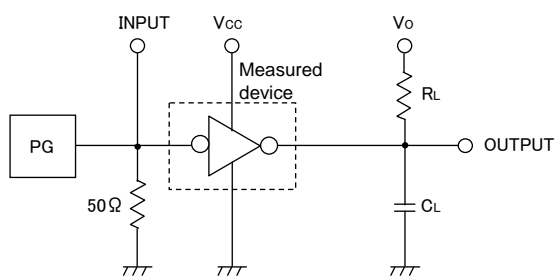

- (1) Pulse generator (PG) characteristics: PRR = 1kHz, t<sub>w</sub> = 10 μs, t<sub>r</sub> = 6ns, t<sub>f</sub> = 6ns, Z<sub>o</sub> = 50 Ω, V<sub>I</sub> = 1 to 4V
- (2) Input-output conditions : R<sub>L</sub> = 30 Ω, V<sub>O</sub> = 10V, V<sub>CC</sub> = 4V
- (3) Electrostatic capacity C<sub>L</sub> includes floating capacitance at connections and input capacitance at probes

**TIMING DIAGRAM**

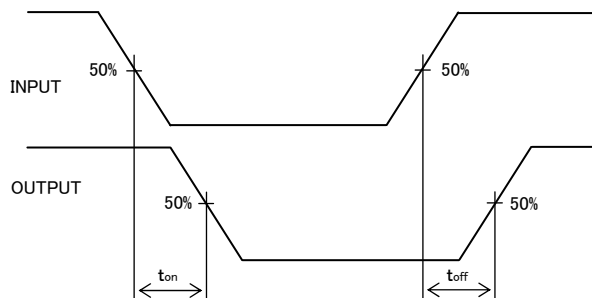

TYPICAL CHARACTERISTICS

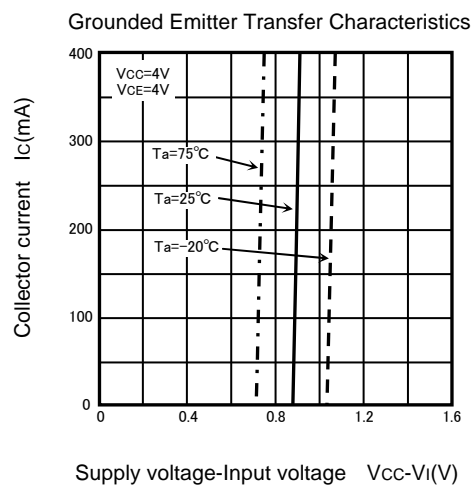
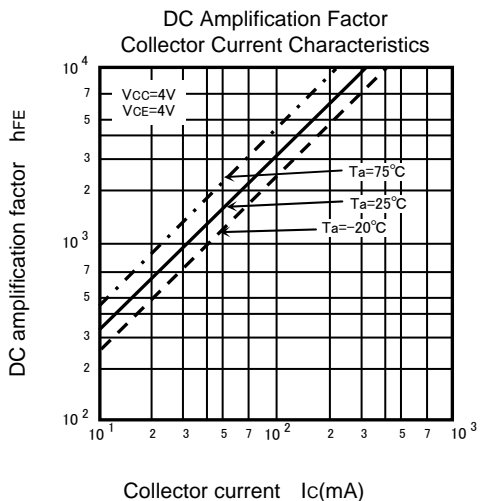
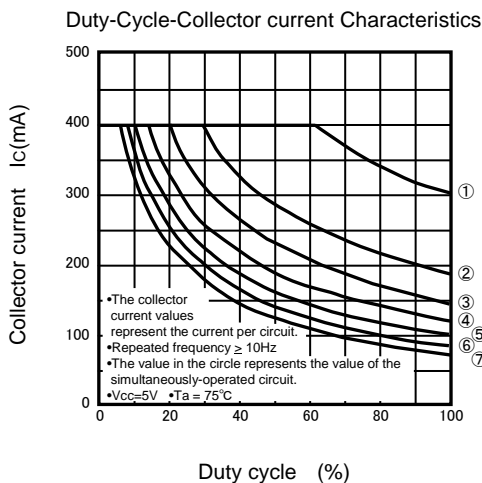
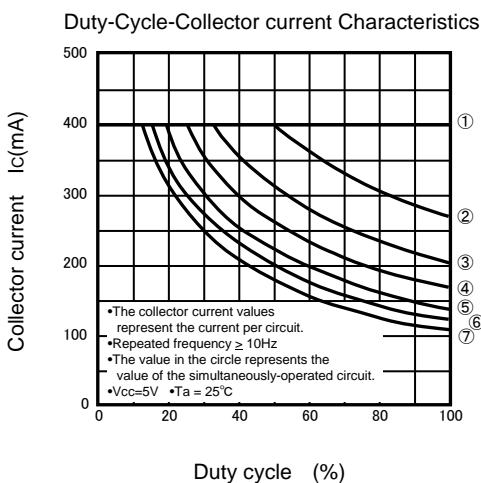
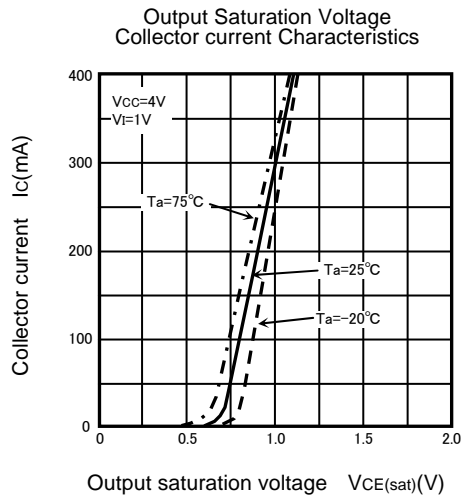
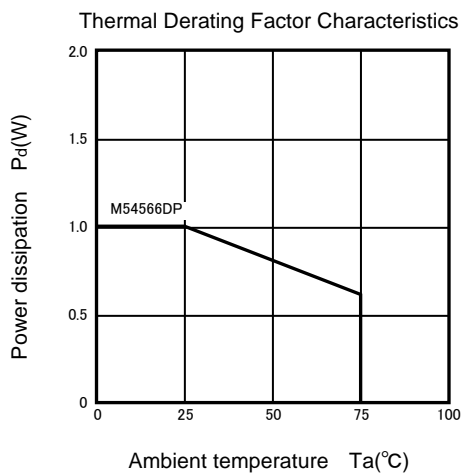

Input Characteristics

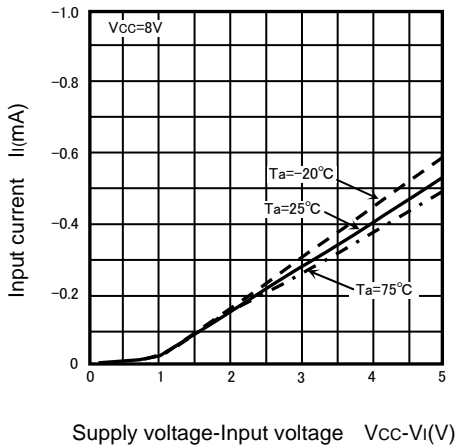

Supply Current Characteristics

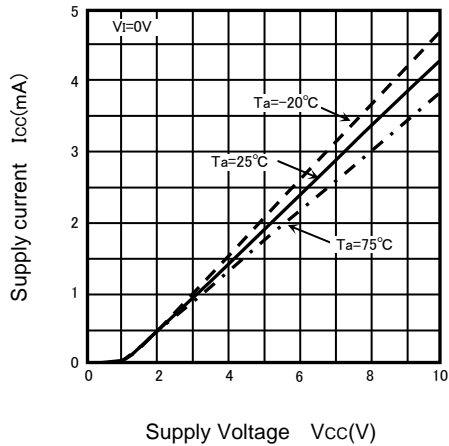

PRELIMINARY

7-UNIT 400mA DARLINGTON TRANSISTOR ARRAY

PACKAGE OUTLINE

16P2X-B

Plastic 16pin 225mil SOP

